

Evaluating the **ADUX1020** Photometric Sensor for Gesture and Proximity

FEATURES

ADUX1020 full configuration

Register level

Parameter level

Graph views

Time series view

Gesture recognition view

UDP transfer capability

EVALUATION KIT CONTENTS

ADUX1020-EVAL-MCM standard evaluation board

ADUX1020-EVAL-SMALL breakout board

EVAL-SDP-CB1Z controller board

Mini USB cable

ADDITIONAL EQUIPMENT NEEDED

PC running Windows 7 operating system

ADUX1020-EVALZ-LED daughterboard (optional)

ONLINE RESOURCES

ADUX1020 data sheet

Optical Gesture Evaluation Tool

GENERAL DESCRIPTION

The **ADUX1020-EVAL-SDP** evaluation kit provides users with a simple means of interfacing with the **ADUX1020**, collecting data from the **ADUX1020**, and evaluating gesture recognition capabilities.

The **ADUX1020-EVAL-SDP** is a kit that includes the **ADUX1020-EVAL-SMALL** and the **ADUX1020-EVAL-MCM**.

The evaluation kit requires the **Optical Gesture Evaluation Tool**, which can be downloaded from the **ADUX1020-EVAL-SDP** product page, a graphical user interface (GUI) that provides users with low level and high level configurability, real-time data analysis, and user datagram protocol (UDP) transfer capability so the evaluation board can easily interface to a PC.

The USB port of the PC powers the **ADUX1020-EVAL-SDP** kit. On-board voltage regulators provide voltage supplies for the **ADUX1020**.

The evaluation board schematics indicate signal names for easy identification. For additional information on the functionality of the **ADUX1020**, refer to the **ADUX1020** data sheet.

ADUX1020-EVAL-SDP EVALUATION KIT PHOTOGRAPH

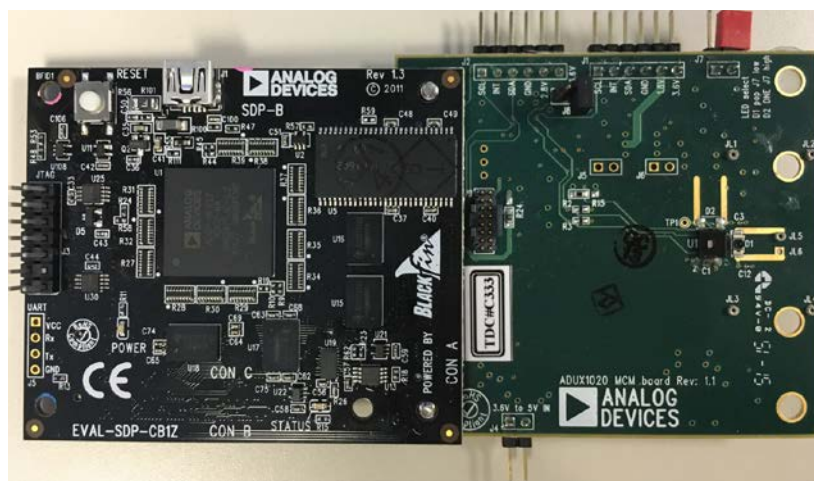

Figure 1.

TABLE OF CONTENTS

Features	1	Evaluation Board USB Connection	3
Evaluation Kit Contents.....	1	Configuring the ADUX1020-EVAL-SDP Evaluation KIT	3
Additional Equipment Needed	1	Streaming Data	4
Online Resources	1	Gesture Recognition	4
General Description	1	Additional Evaluation Boards.....	5
ADUX1020-EVAL-SDP Evaluation Kit Photograph	1	High power LED daughterboard.....	5
Revision History	2	Small Form-Factor Breakout Board.....	5
Evaluation Board Software Quick Start Procedures	3	Evaluation Board Schematics and Artwork	6
Installing the Optical Gesture Evaluation Tool	3		

REVISION HISTORY

6/2016—Revision 0: Initial Version

EVALUATION BOARD SOFTWARE QUICK START PROCEDURES

INSTALLING THE OPTICAL GESTURE EVALUATION TOOL

Download the [Optical Gesture Evaluation Tool](#) software package from the [ADUX1020-EVAL-SDP](#) product page. Unzip the downloaded software folder, run the enclosed `ADI_OpticalGesture_EvaluationTool.exe` file, and follow the prompts for installing the [Optical Gesture Evaluation Tool](#) software (see Figure 2). For further information, follow the full installation guide included with the [Optical Gesture Evaluation Tool](#) software in the downloaded folder.

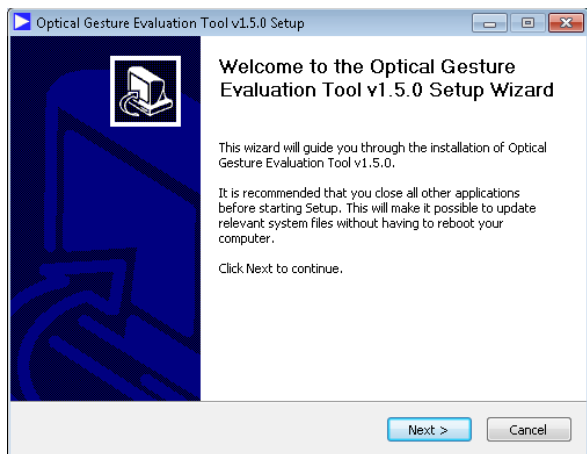

Figure 2. *Optical Gesture Evaluation Tool Setup*

To start the [Optical Gesture Evaluation Tool](#) application, navigate to the `ADI_OpticalGesture_EvaluationTool` from the **Start** menu and click the `ADI_OpticalGesture_EvaluationTool` icon (see Figure 3).

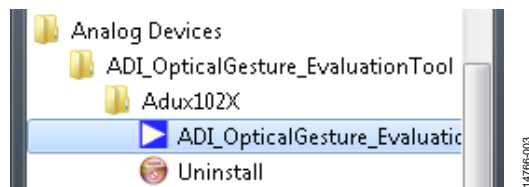

Figure 3. *Navigate to **Optical Gesture Evaluation Tool** from **Start** Menu*

At startup, the [Optical Gesture Evaluation Tool](#) application automatically checks if the installed [Optical Gesture Evaluation Tool](#) software version is up to date. If there is a newer version available, the user is prompted to download the newest version.

EVALUATION BOARD USB CONNECTION

Ensure the provided [EVAL-SDP-CB1Z](#) controller board and [ADUX1020-EVAL-MCM](#) connect together and connect to a PC via the USB cable included with the evaluation kit. After the [Optical Gesture Evaluation Tool](#) application opens, click **File > Connect** (see Figure 4) and select **SDP ASIC Bridge (Debug)**. The [Optical Gesture Evaluation Tool](#) then acknowledges the [ADUX1020-EVAL-SDP](#) kit is connected.

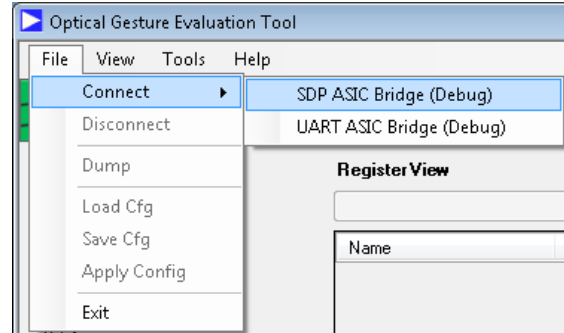

Figure 4. *SDP ASIC Connection*

CONFIGURING THE ADUX1020-EVAL-SDP EVALUATION KIT

Before operating the [ADUX1020-EVAL-SDP](#) kit, connect any jumper across Header J7 on the [ADUX1020-EVAL-MCM](#). If using the [ADUX1020-EVALZ-LED](#) daughterboard, disconnect the jumper from Header J7.

To operate the [ADUX1020](#) in gesture detect mode, click **File > Load Cfg**. Select the `004_ADUX1020_StandardR1.dcfg` file and click **Open** (see Figure 5).

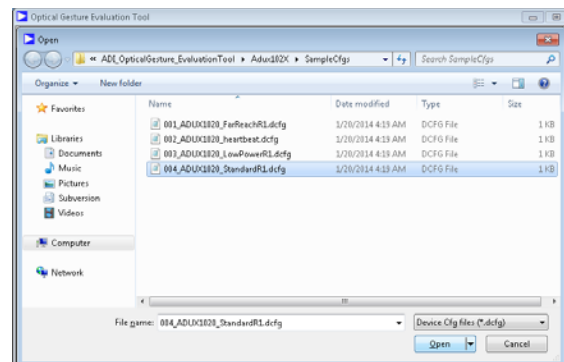

Figure 5. *Loading the Configuration File*

Next, click **View > Off-Chip Analysis and Gesture View** to open the **Graph XYI** tab (see Figure 6). With the evaluation board positioned so there are no objects around it within at least a 20 cm radius, click the **Channel Auto Calibration** button to calibrate the [ADUX1020-EVAL-SDP](#) kit. The [Optical Gesture Evaluation Tool](#) then acknowledges if calibration is successful.

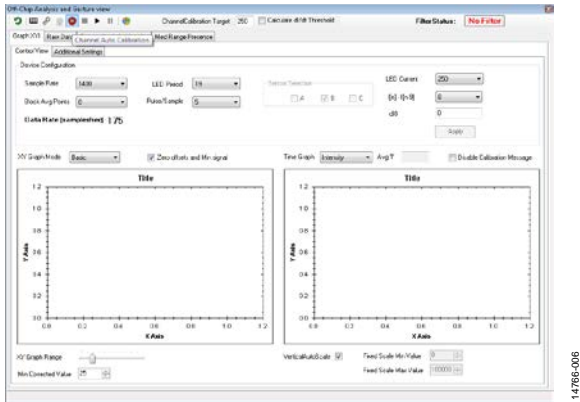

Figure 6. Running the Channel Auto Calibration

STREAMING DATA

Press the **Play** button to begin streaming data from the evaluation board. Move an object or hand within 15 cm above the **ADUX1020** to see the corresponding output of the device on the graphs. The **Y Ratio vs X Ratio** graph shows the calculated x, y position of the object above the device (see Figure 7). The **Intensity** graph shows the average intensity of reflected light seen by the device, represented in ADC codes.

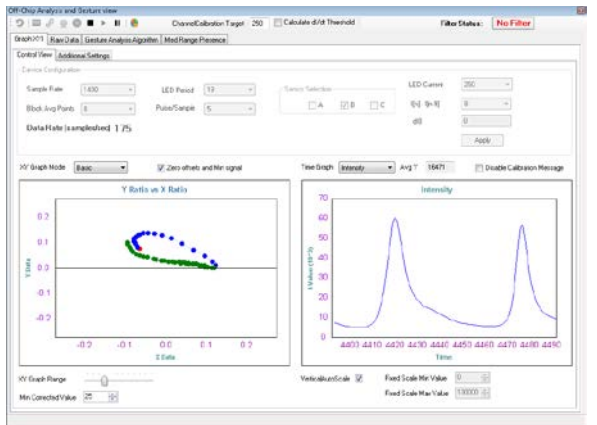

Figure 7. Graph of Streaming Data

GESTURE RECOGNITION

To view the gesture recognition capability, navigate to the **Gesture Analysis Algorithm** tab and select **LSLF Swipe determination** from the drop-down menu. Click the **Play** button if the device is not already streaming data.

Move a hand within 15 cm above the device and swipe in any of the four indicated directions. Alternatively, the center indicator can be activated by quickly lowering a hand towards the sensor (see Figure 8).

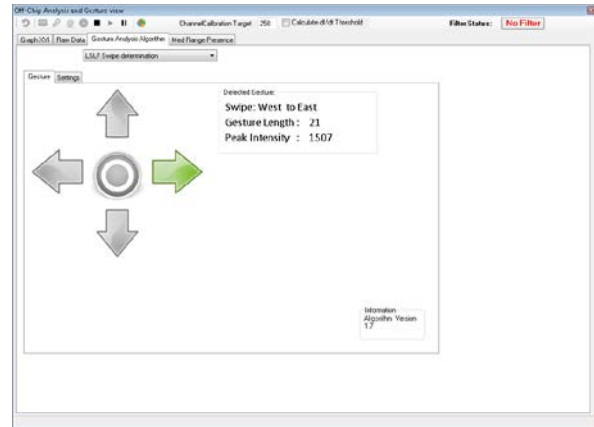

Figure 8. Gesture Recognition Algorithm Tab

For more detailed information [Optical Gesture Evaluation Tool](#) and additional features of the software, see the **Optical Gesture Evaluation Tool User Manual**, which can be found in the **Help > Help Topics** menu.

ADDITIONAL EVALUATION BOARDS

HIGH POWER LED DAUGHTERBOARD

The [ADUX1020-EVALZ-LED](#) is an optional daughterboard for the standard [ADUX1020-EVAL-MCM](#) evaluation board. It functions as a high-power LED driver intended for gesture recognition at distances greater than 15 cm.

To use the [ADUX1020-EVALZ-LED](#), attach it to the [ADUX1020-EVAL-MCM](#) evaluation board as shown in Figure 9. The daughterboard connects to the [ADUX1020-EVAL-MCM](#) via five pins, labeled on the daughterboard as GND, GND1, LEDX, 3.3V, and VLED. These pins on the daughterboard plug into five similarly spaced test points on the [ADUX1020-EVAL-MCM](#) labeled JL1, JL2, JL3, JL4, and JL5. When connecting the [ADUX1020-EVALZ-LED](#), ensure Header J7 on the [ADUX1020-EVAL-MCM](#) is not connected, as shown in Figure 9.

Operation and configuration of the [ADUX1020-EVAL-SDP](#) with the [ADUX1020-EVALZ-LED](#) daughterboard follows the instructions listed in the Evaluation Board Software Quick Start Procedures section.



Figure 9. Connecting the [ADUX1020-EVALZ-LED](#) Daughterboard

SMALL FORM-FACTOR BREAKOUT BOARD

The [ADUX1020-EVAL-SMALL](#) is a small form-factor breakout board (see Figure 10) for the [ADUX1020](#) that allows easy access to the [ADUX1020](#) pinout via a standard connector cable.

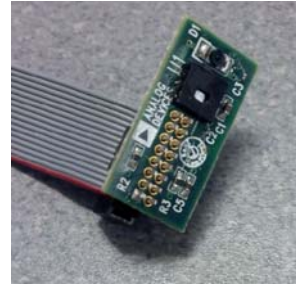

Figure 10. [ADUX1020-EVAL-SMALL](#) Breakout Board

The top view of the connector pinout for the [ADUX1020-EVAL-SMALL](#) is shown in Figure 11.

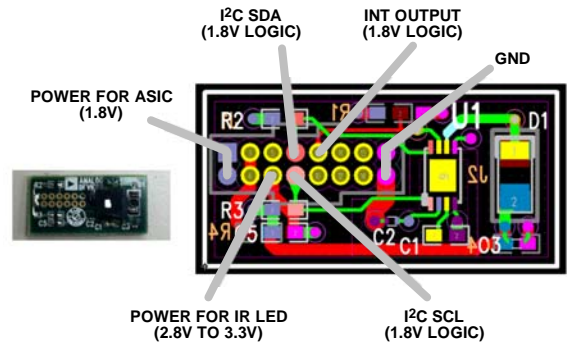

Figure 11. [ADUX1020-EVAL-SMALL](#) Breakout Board

EVALUATION BOARD SCHEMATICS AND ARTWORK

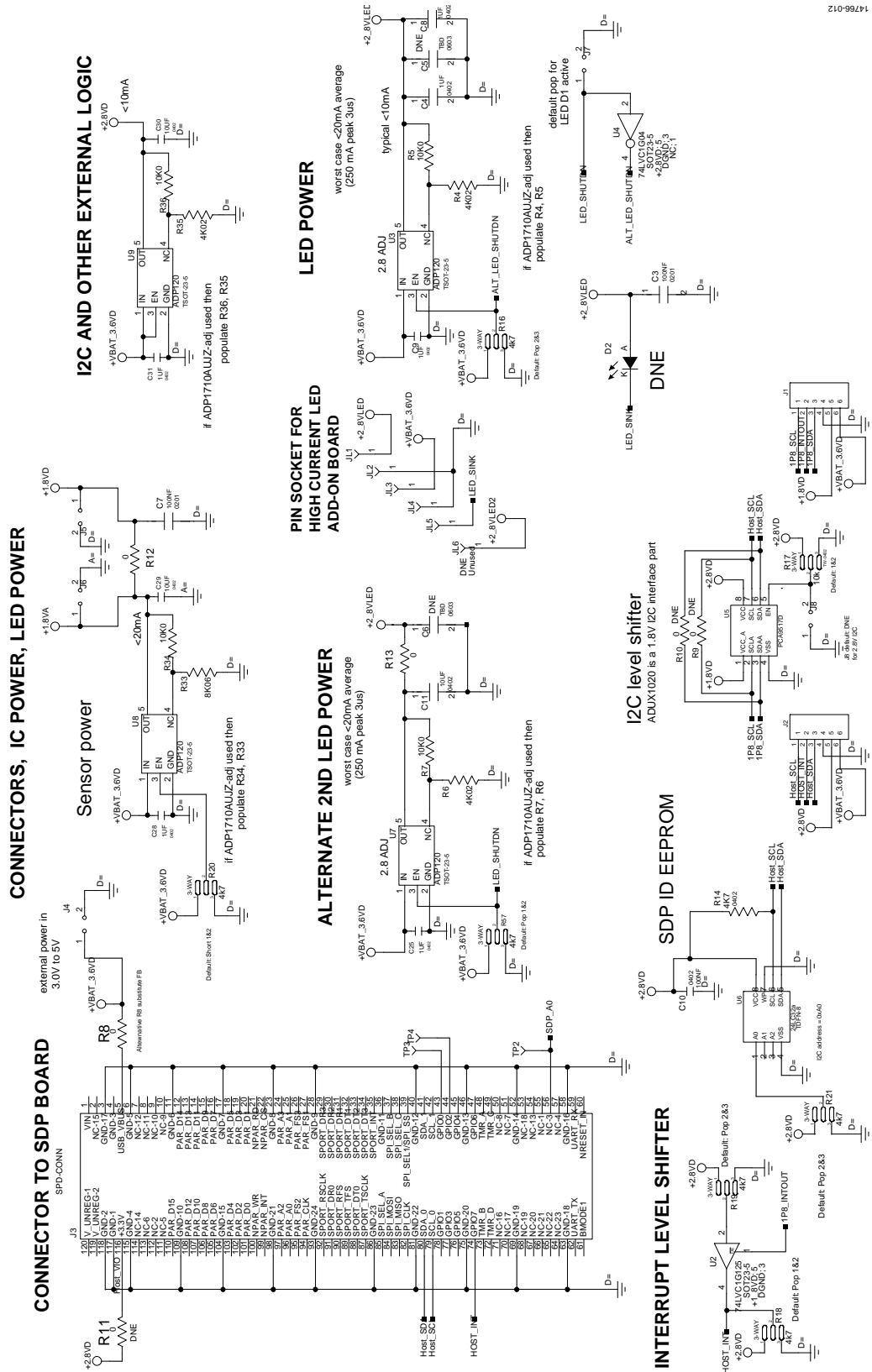
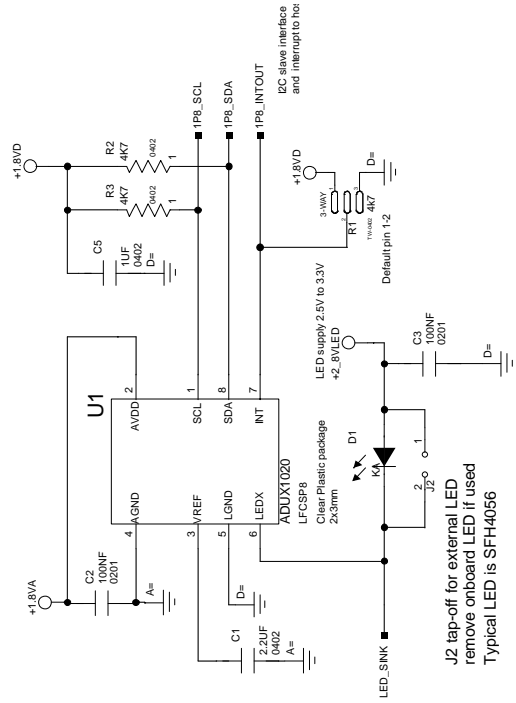

Figure 12. ADUX1020-EVAL-MCM Evaluation Board Schematic



14766-013

NOTES
 1. IN THE ADUX1020, LGND MEANS DGND AND AVDD MEANS VDD.

2x8 pin header
 0.05" pitch

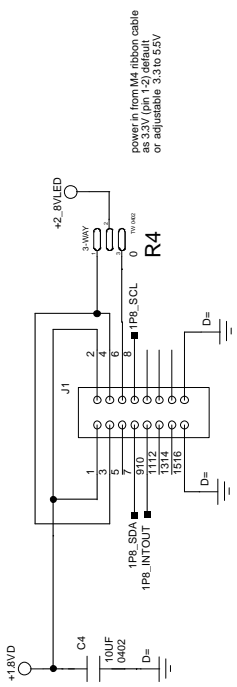

Power is from Mx ribbon cable
 3.3V (or 2) default
 or adjustable 3.3 to 5.5V

These resistors below are not in the BOM
 indicates a trace connection between planes

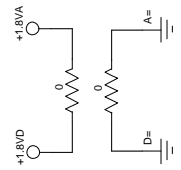

Figure 13. ADUX1020-EVAL-SMALL Small Form-Factor Breakout Board Schematic

NOTES



ESD Caution

ESD (electrostatic discharge) sensitive device. Charged devices and circuit boards can discharge without detection. Although this product features patented or proprietary protection circuitry, damage may occur on devices subjected to high energy ESD. Therefore, proper ESD precautions should be taken to avoid performance degradation or loss of functionality.

Legal Terms and Conditions

By using the evaluation board discussed herein (together with any tools, components documentation or support materials, the "Evaluation Board"), you are agreeing to be bound by the terms and conditions set forth below ("Agreement") unless you have purchased the Evaluation Board, in which case the Analog Devices Standard Terms and Conditions of Sale shall govern. Do not use the Evaluation Board until you have read and agreed to the Agreement. Your use of the Evaluation Board shall signify your acceptance of the Agreement. This Agreement is made by and between you ("Customer") and Analog Devices, Inc. ("ADI"), with its principal place of business at One Technology Way, Norwood, MA 02062, USA. Subject to the terms and conditions of the Agreement, ADI hereby grants to Customer a free, limited, personal, temporary, non-exclusive, non-sublicensable, non-transferable license to use the Evaluation Board FOR EVALUATION PURPOSES ONLY. Customer understands and agrees that the Evaluation Board is provided for the sole and exclusive purpose referenced above, and agrees not to use the Evaluation Board for any other purpose. Furthermore, the license granted is expressly made subject to the following additional limitations: Customer shall not (i) rent, lease, display, sell, transfer, assign, sublicense, or distribute the Evaluation Board; and (ii) permit any Third Party to access the Evaluation Board. As used herein, the term "Third Party" includes any entity other than ADI, Customer, their employees, affiliates and in-house consultants. The Evaluation Board is NOT sold to Customer; all rights not expressly granted herein, including ownership of the Evaluation Board, are reserved by ADI. CONFIDENTIALITY. This Agreement and the Evaluation Board shall all be considered the confidential and proprietary information of ADI. Customer may not disclose or transfer any portion of the Evaluation Board to any other party for any reason. Upon discontinuation of use of the Evaluation Board or termination of this Agreement, Customer agrees to promptly return the Evaluation Board to ADI. ADDITIONAL RESTRICTIONS. Customer may not disassemble, decompile or reverse engineer chips on the Evaluation Board. Customer shall inform ADI of any occurred damages or any modifications or alterations it makes to the Evaluation Board, including but not limited to soldering or any other activity that affects the material content of the Evaluation Board. Modifications to the Evaluation Board must comply with applicable law, including but not limited to the RoHS Directive. TERMINATION. ADI may terminate this Agreement at any time upon giving written notice to Customer. Customer agrees to return to ADI the Evaluation Board at that time. LIMITATION OF LIABILITY. THE EVALUATION BOARD PROVIDED HEREUNDER IS PROVIDED "AS IS" AND ADI MAKES NO WARRANTIES OR REPRESENTATIONS OF ANY KIND WITH RESPECT TO IT. ADI SPECIFICALLY DISCLAIMS ANY REPRESENTATIONS, ENDORSEMENTS, GUARANTEES, OR WARRANTIES, EXPRESS OR IMPLIED, RELATED TO THE EVALUATION BOARD INCLUDING, BUT NOT LIMITED TO, THE IMPLIED WARRANTY OF MERCHANTABILITY, TITLE, FITNESS FOR A PARTICULAR PURPOSE OR NON-INFRINGEMENT OF INTELLECTUAL PROPERTY RIGHTS. IN NO EVENT WILL ADI AND ITS LICENSORS BE LIABLE FOR ANY INCIDENTAL, SPECIAL, INDIRECT, OR CONSEQUENTIAL DAMAGES RESULTING FROM CUSTOMER'S POSSESSION OR USE OF THE EVALUATION BOARD, INCLUDING BUT NOT LIMITED TO LOST PROFITS, DELAY COSTS, LABOR COSTS OR LOSS OF GOODWILL. ADI'S TOTAL LIABILITY FROM ANY AND ALL CAUSES SHALL BE LIMITED TO THE AMOUNT OF ONE HUNDRED US DOLLARS (\$100.00). EXPORT. Customer agrees that it will not directly or indirectly export the Evaluation Board to another country, and that it will comply with all applicable United States federal laws and regulations relating to exports. GOVERNING LAW. This Agreement shall be governed by and construed in accordance with the substantive laws of the Commonwealth of Massachusetts (excluding conflict of law rules). Any legal action regarding this Agreement will be heard in the state or federal courts having jurisdiction in Suffolk County, Massachusetts, and Customer hereby submits to the personal jurisdiction and venue of such courts. The United Nations Convention on Contracts for the International Sale of Goods shall not apply to this Agreement and is expressly disclaimed.

©2016 Analog Devices, Inc. All rights reserved. Trademarks and registered trademarks are the property of their respective owners.
UG14766-0-6/16(0)



www.analog.com