

# **AT89STK-06 Demo Board**

---

## **Hardware User Guide**





---

**Section 1**

Introduction .....	1-1
1.1 Features .....	1-1

---

**Section 2**

Hardware Description .....	2-3
2.1 Block Diagram .....	2-3
2.2 Power Supply .....	2-3
2.3 RESET .....	2-4
2.4 Serial Interfaces .....	2-5
2.5 Board Settings .....	2-7

---

**Section 3**

Device Programming .....	3-11
3.1 In-System Programming .....	3-11

---

**Section 4**

Appendix A: Board Layout .....	4-13
Appendix B: Bill of Materials .....	4-14
Appendix C: Board Schematics .....	4-15
Appendix D: Default Configuration .....	4-19
Appendix E: References/Acronyms .....	4-20
4.1 References .....	4-20
4.2 Acronyms .....	4-20



# Section 1

## Introduction

This document describes the board included in the AT89STK-06 Starter Kit dedicated to the T89C51CC01/CC02 and AT89C51CC03 CAN microcontrollers (for T89C51CC02 optional adaptor is required). This board is designed to allow an easy evaluation of the product using demonstration software.

The AT89STK-06 Starter Kit can be used with the AT89C51AC3, TR89C51AC2, and T89C5115 Flash Microcontrollers with ADC (for T89C5115 optional adaptor is required).

### 1.1 Features

- **CAN**
  - On board CAN transceiver Atmel ATA6660
  - D-sub Connector Compliant to the CiA (User Group: "CAN in Automation") Recommendation for the CAN High Speed Bus
- **Two Different Sockets to Support AT89C51CC03 and AT89C51AC3 in PLCC52 and all controllers in PLCC44 Packages**
- **Support of the T89C51CC02 & T89C5115 Microcontroller Requires the use of a PLCC28 Adapter (CANADAPT28).**
- **The Board Comes with a AT89C51CC03-UA (PLCC44 package) and a AT89C51CC03-CA (PLCC52 package) Samples<sup>(1)</sup>.**
- **Analog-to-Digital Converter**
  - Potentiometer
  - Thermal Resistor
  - On board ADC Reference Voltage
- **On-board Reset, INT0, INT1, LEDs, EA, ISP and Programming Interface**
- **Power, ALE, RS232 Rx and Tx LEDs**
- **CAN, SPI and RS232 Hardware Connectors**
- **On-board Voltage Regulator**
- **Voltage Operation: 8V to 15V**
- **Operating Temperature Range: 0 to +70°C**
- **Dimension: 80 mm x 100 mm**

**Notes:** 1. Samples for AT89C51AC3, T89C51CC01, T89C51AC2, T89C51CC02, and T89C5115 can be ordered separately

Figure 1-1. AT89STK-06 board

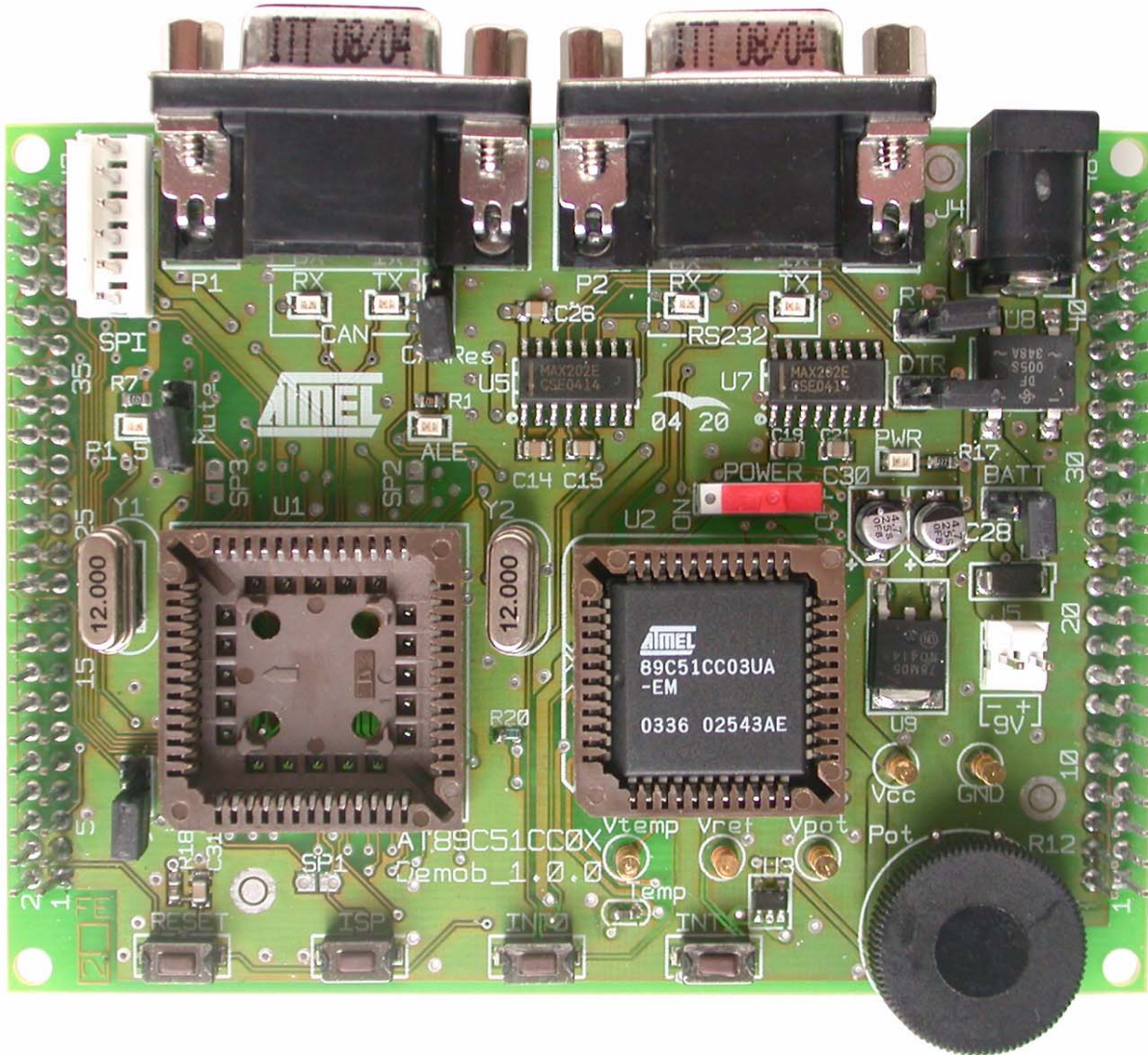

## Hardware Description

**2.1 Block Diagram** Figure 2-1 shows a functional block diagram of the AT89STK-06 board, with the I/O usage.

**Figure 2-1.** Block Diagram of AT89STK-06 board

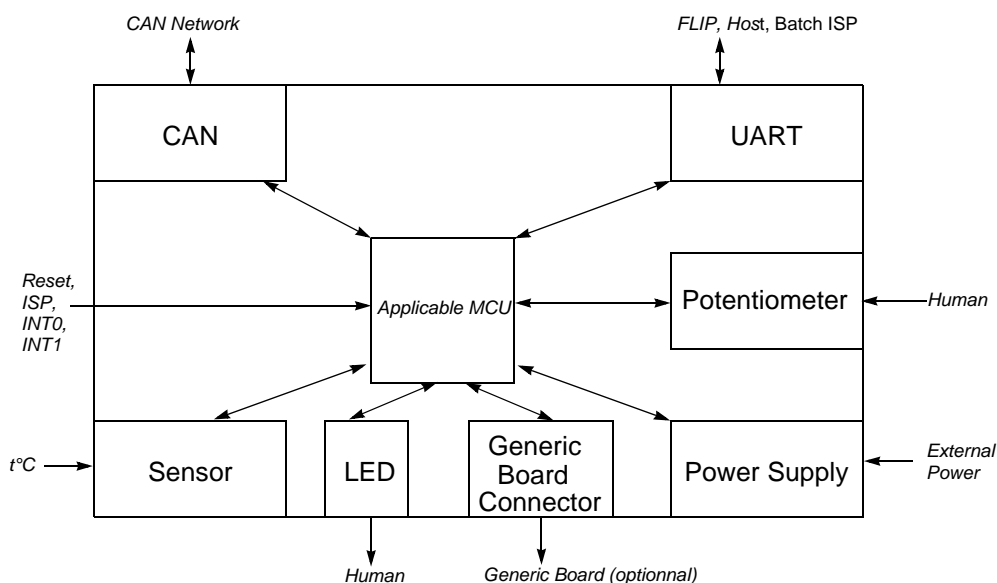

**2.2 Power Supply** The on-board power supply circuitry allows various power supply configurations.

**2.2.1 Power Supply Sources**

The power supply source can come from two different and **exclusive** sources:

- either from J4, JACK PWR connector
- either from J5, 9V (Battery connector)

- J4 - JACK PWR connector:*
- Need of a male JACK outlet
  - Input supply from 8 up to 15V DC 500mA min

- No specific polarization mandatory

**Note:** There is a diode voltage level between the negative output of the power supply and the “GND”. This could introduce some gap of voltage during measurement and instrumentation.

**Figure 2-2 .** Male JACK Outlet and Wires

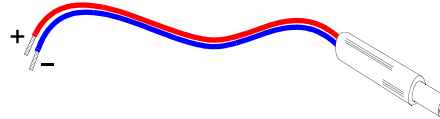

**Caution:** Do not mount more than **one** power supply source on AT89STK-06 board.

J5 - 9V Battery connector:

- Need of a female 2 points connector
- Input supply from 6 up to 10V DC (example: 9V battery)
- Polarization mandatory

**Figure 2-3 .** EXT PWR Female Connector / Cable for 9V Battery

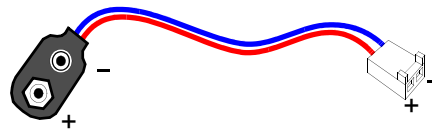

**Caution:** Do not mount more than **one** power supply source on AT89STK-06 Starter Kit.

---

<b>2.3</b>	<b>RESET</b>	Although the AT89C51CC03 & AT89C51AC3 microcontrollers have on-chip RESET circuitry (c.f. microcontroller datasheet), the AT89STK-06 board provides to the microcontroller a RESET signal witch can come from 2 different sources:
<b>2.3.1</b>	<b>Power-on RESET</b>	The on-board RC network acts as power-on RESET.
<b>2.3.2</b>	<b>RESET Push Button</b>	By pressing the RESET push button on the AT89STK-06 board, a warm RESET of the microcontroller is performed.

## 2.4 Serial Interfaces

### 2.4.1 RS-232C

All CAN microcontrollers have one on-chip UART peripheral. Only the asynchronous mode is supported by the AT89STK-06 board.

The AT89STK-06 board is supplied with a RS-232 driver/receiver. Only one female DB9 connector assumes the RS-232 connections. A full range of configuration can be set with two Rx lines and two Tx lines.

**Figure 2-4 .** RS-232 DB9 Connections

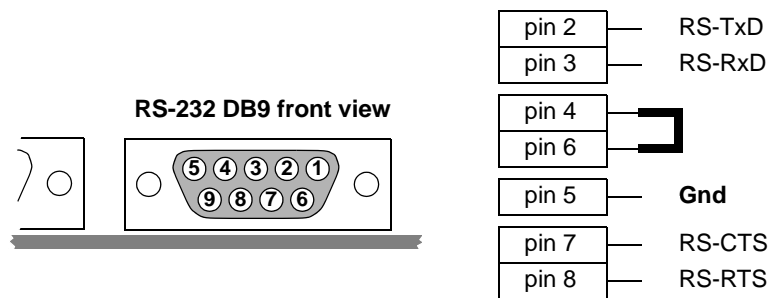

**Figure 2-5 .** Typical PC Connection Lay-out

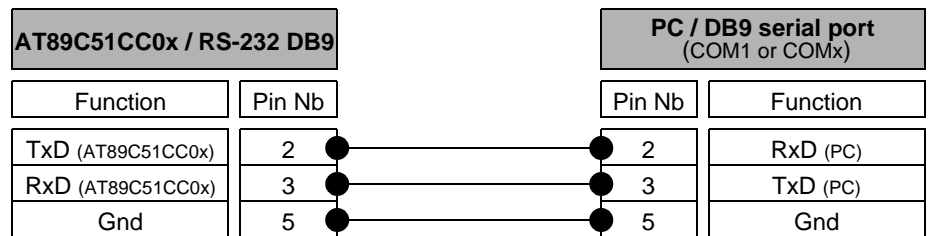

**Figure 2-6.** RS-232 DB9

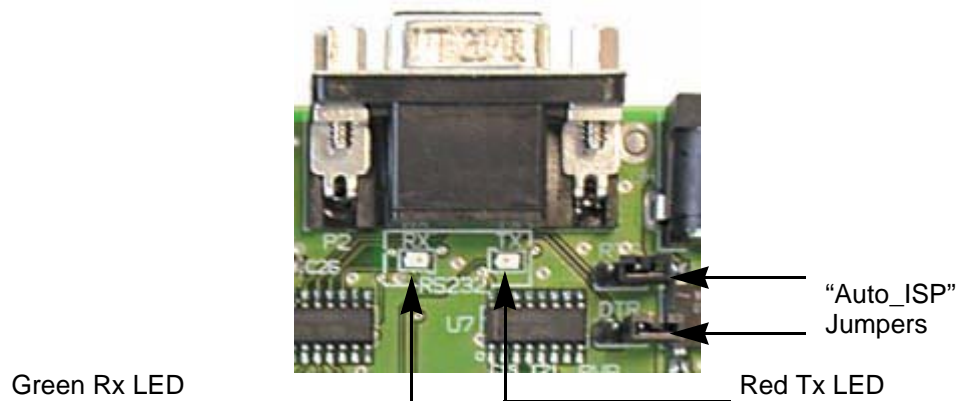

2.4.2 CAN

The microcontroller is a microcontroller with an on-chip full-CAN controller.

The AT89STK-06 board is supplied with an Atmel CAN transceiver (ATA6660). A female DB9 connector assumes the CAN bus connections.

Figure 2-7 . CAN DB9 Connections

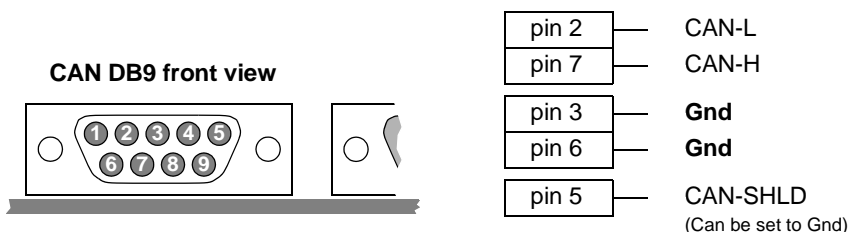

If a network termination is needed, JP3 switch inserts a 120Ω resistor between CAN-H and CAN-L.

A red LED indicates a TxCAN traffic, a green one indicates a RxCAN traffic.

Figure 2-8 . CAN LEDs

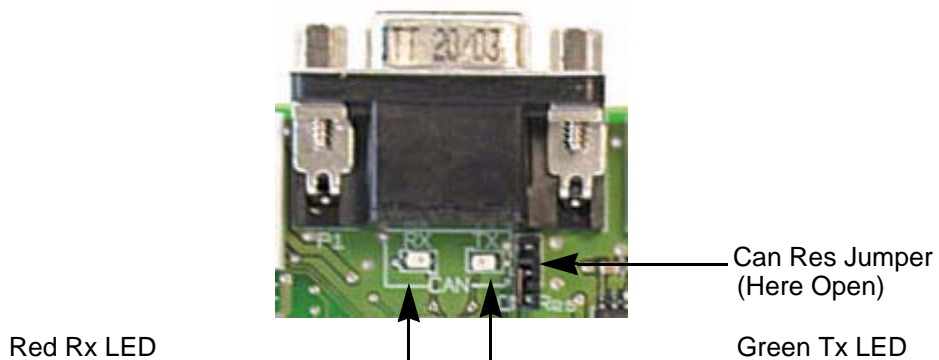

2.4.3 SPI

The AT89C51CC03 in PLCC52 is a microcontroller with an on-chip full duplex SPI interface, master or slave.

A 6-pin male connector assumes the SPI bus connections. The SPI 6-pin connector also provides to the user Vcc and Gnd.

Figure 2-9 . SPI 6-pin Connections

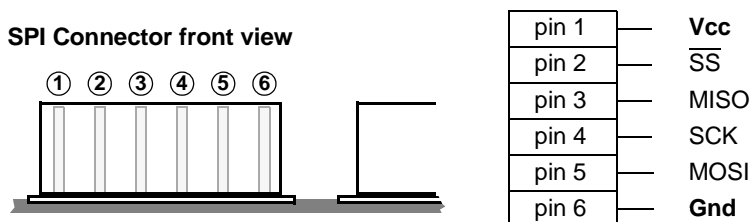



## 2.5 Board Settings

The AT89STK-06 board has two types of settings:

- Jumpers
- Solder strap
- Test points

Table 2-1, Table 2-2 and Table 2-3 provide an overview of the available settings and test points.

### 2.5.1 Jumpers

**Table 2-1.** Default Jumper Setting

Reference	PCB Name	Comments (guidelines)	Default
JP1	EA	ON : allows external execution OFF: Internal code execution	Open (OFF)
JP2	MUTE	ON : Enable C51 generic extension board (optional) buzzer OFF: Disable C51 generic extension board (optional) buzzer	Open (OFF)
JP3	CANRes	ON : Enable CAN terminator resistor OFF: Disable CAN terminator resistor	Open (OFF)
JP4	RTS	ON : Enable RTS line to control ISP mode (for AutoISP mode) OFF: Disable RTS line to control ISP mode	Open (OFF)
JP5	DTR	ON : Enable DTR line to drive MCU reset (for AutoISP mode) OFF: Disable DTR line to drive MCU reset	Open (OFF)
JP6	Batt	ON : Enable Battery charge OFF: Disable Battery charge	Open (OFF)

**Figure 2-10.** Jumper Setting Definition

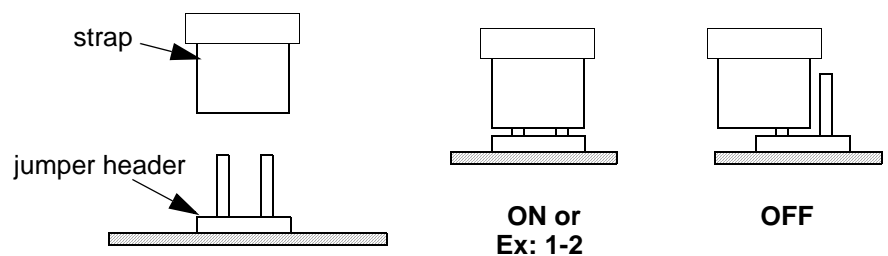

**2.5.2 Solder straps** Solder straps allow to modify the board configuration for specific usage such as T89C51CC02 compatibility.

**Table 2-2.** Table of Solder Strap

Reference	PCB Name	Comments (guidelines)	Default
SP1	CC02 & C5115 mode	For T89C51CC02 usage, allows to redirect the ISP signal to P1.0, for hardware conditions.	Open
SP2	X2_44	Connect PLCC44 Xtal2 to XTAL2 of the generic extension board (optional)	Open
SP3	X2_52	Connect PLCC52 Xtal2 to XTAL2 of the generic extension board (optional)	Open

**Figure 2-11.** Solder Strap definition

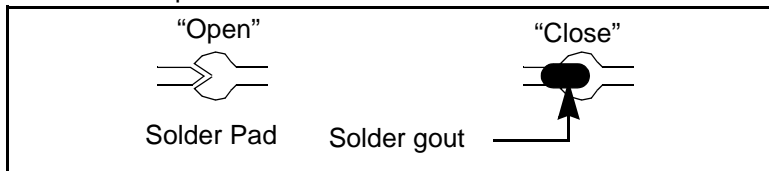

**2.5.2.1 T89C51CC02/T89C5115 Support (SP1)** When using T89C51CC02 or T89C5115 products with the AT89STK-06 board ( see "PLCC adapter for T89C51CC02 user guide: CANADAPT28), the SP1 solder pad should be closed to ensure correct hardware conditions setting on P1.0 port.

SP1 solder pad connects ISP push button to P1.0 microcontroller port and the CANADAPT28 adapter should be inseted in U2 (PLCC44) socket.

**Figure 2-12.** AT89STK-06 Board with CANADAPT28

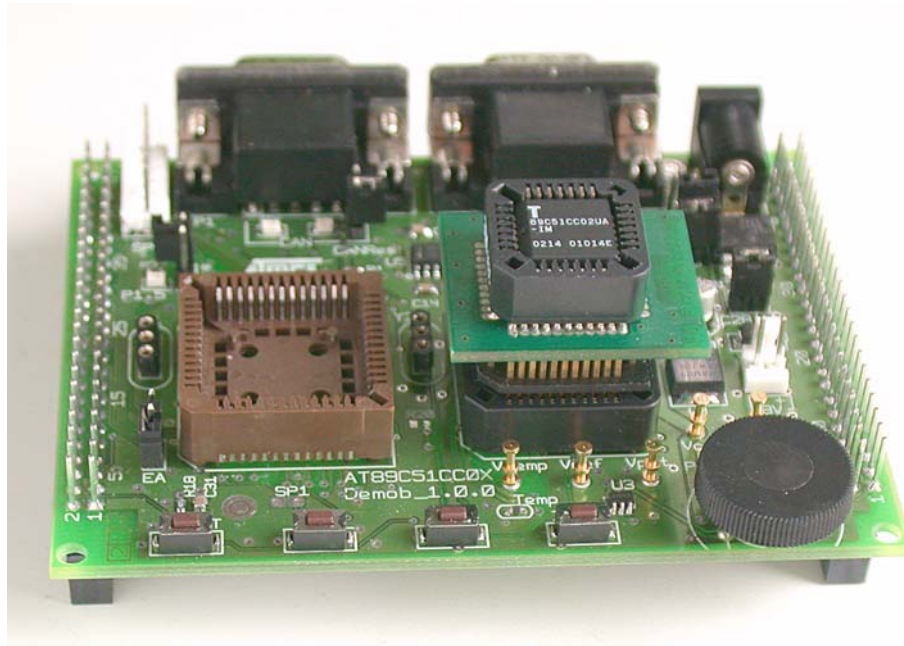



### 2.5.3 Test Points

Test points are used to check the internal power supply for AT89STK-06 Board.

**Table 2-3.** Table of Test Points

Reference	PCB Name	Comments (guidelines)
TP1	Vref	Vref for ADC
TP2	Vpot	Test point for Potentiometer voltage
TP3	Vtemp	Test point for Thermal resistor voltage
TP4	Vcc	Test point for Vcc
TP5	GND	Test point for GND



## Section 3

# Device Programming

- 
- 3.1 In-System Programming** The on-chip memories and configuration bytes of the AT89C51CC0x parts can be programmed using the ISP mode of the device.
- 3.1.1 Manual ISP Mode**
- 3.1.1.1 Board Configuration** To use ISP mode, the board should be configured as follow:
- POWER switch (SW1) on “ON” position
  - EA jumper should be open (internal code execution only).
  - Before using ISP mode for T89C51CC02 or T89C5115 device, be sure to close SP1 solder pad ( See Section "T89C51CC02/T89C5115 Support (SP1)", page 8).
- 3.1.1.2 Operating Mode** To enter in ISP mode, press both the RESET (SW5) and ISP (SW4) buttons simultaneously. First release the RESET button and then the ISP button. The device enters in ISP mode.
- 3.1.2 Auto ISP Mode** The Auto ISP is available only for parts with UART bootloader (-UA devices). It allows the host PC application (Atmel FLIP software for example) to control the hardware conditions from the serial lines RTS and DTR.
- Thus with the Auto ISP mode, the user does not need to push the ISP and RESET buttons.
- 3.1.2.1 Board Configuration** To use Auto ISP mode, put the board in the same configuration as ISP mode and also:
- Close RTS (JP4) jumper
  - Close DTR (JP5) jumper





## Section 4

# Appendix A: Board Layout

Figure 4-1. Board Components View Diagram

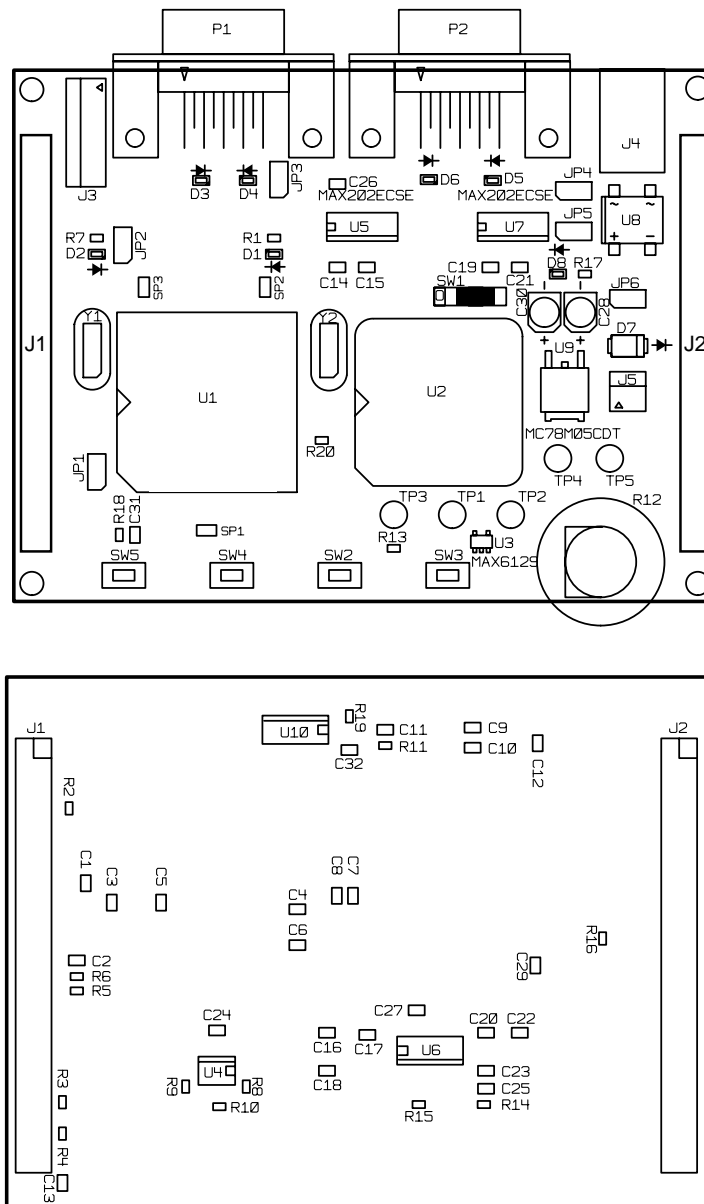

# Appendix B: Bill of Materials

Figure 4-2. Bill of Materials Table

Item	Code no	Description	Quantity	Reference
1	74HC125-SO	74HC125 SO14	1	U6
2	74HC14-SO	74HC14 SO14	1	U10
3	AT89C51CC01-SPLC	PLCC44	1	U2
4	AT89C51CC03-SPLC	PLCC52	1	U1
5	ATA6660-SO8	ATA6660 CAN TRANSCEIVER SO8 ATMEL	1	U4
6	MAX202ECSE-SO	MAX202ECSE SO16 MAXIM	2	U5, U7
7	MAX6129-SOT23-5P	MAX6129 SOT23-5 MAXIM	1	U3
8	MC78M05CDT-TO252	REG MC78M05CDT TO252 ON SEMICONDUCT	1	U9
9	PONT-DF005S	PONT REDRESSEUR DF005S GENERAL SEMI	1	U8
10	BAR2	2PTS A 2.54	6	JP1, JP2, JP3, JP4, JP5, JP6
11	BAR2-24-ESQ124-2	2X24PTS A 2.54 ESQ124-24-T-	2	J1, J2
12	BAR2Y-MTA2.54	MALE 2PTS MTA 2.54	1	J5
13	BAR6Y-MTA2.54-IN	MALE 6PTS MTA 2.54 I	1	J3
14	JACK-PWR-D2.5	JACK PWR DIAM 2.5MM	1	J4
15	STR-2CMS-NCC	SOLDER STRAP	3	SP1, SP2, SP3
16	SW-1K2-09-03201-	SW 1K2 09-03201-02 EOA SE	1	SW1
17	BAR3	3PTS A 2.54	2	Y1, Y2
18	DBS09V8G	SUBD FEMALE 90° 9PTS	2	P1, P2
19	BP-DTSM3	BP CMS DTSM3 APEM	4	SW2, SW3, SW4, SW5
20	PT1-6	TEST POINT	5	TP1, TP2, TP3, TP4, TP5, TP6
21	CA-0805-100NF	CAPA CMS 0805 100NF	22	C3, C7, C9, C10, C12, C14, C15, C16, C17, C18, C19, C20, C21, C22, C23, C24, C25, C26, C27, C29, C32
22	CA-0805-10NF	CAPA CMS 0805 10NF	1	C11
23	CA-0805-1UF	CAPA C0805C105Z3VAC KEMET	1	C31
24	CA-0805-22NF	CAPA CMS 0805 22NF	2	C5, C8
25	CA-0805-22PF	CAPA CMS 0805 22PF	4	C1, C2, C4, C6
26	CO-VS-B-4.7UF	CAPA VS-B 4.7UF 35V PANASONIC	2	C28, C30
27	DIO-MRA4007-SMA	DIODE RECTIF. MRA4007 SMA ON	1	D7
28	LED-LPM670-G	MINI TOPLED VERTE LPM670-G OSRAM	3	D1, D4, D5
29	LED-LSM676	HYPER MINI TOPLED SUPER-RED LSM676	4	D2, D3, D6, D8





Figure 4-4. AT89STK-06 Board Schematics (2 of 4)

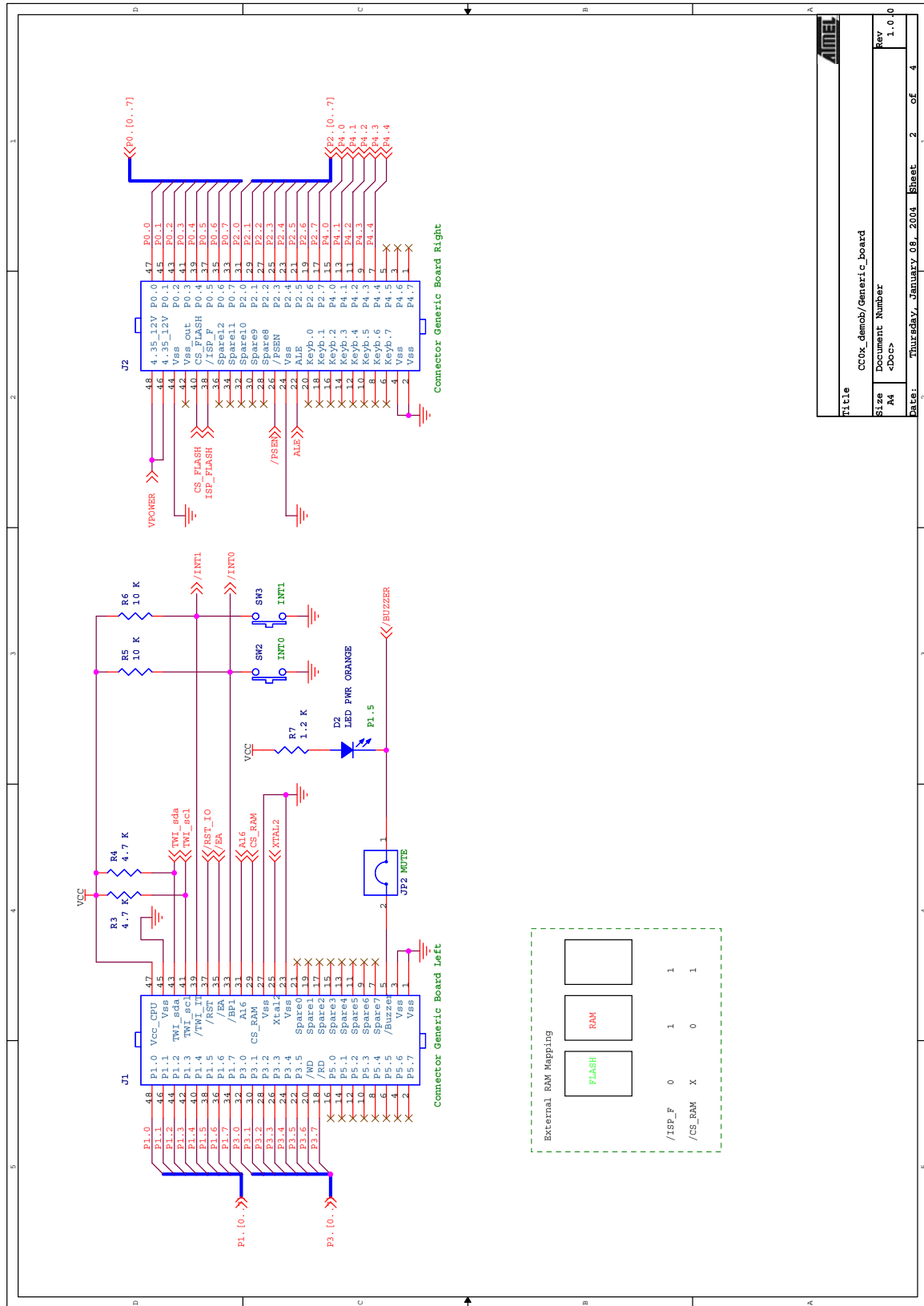

Figure 4-5. AT89STK-06 Board Schematics (3 of 4)

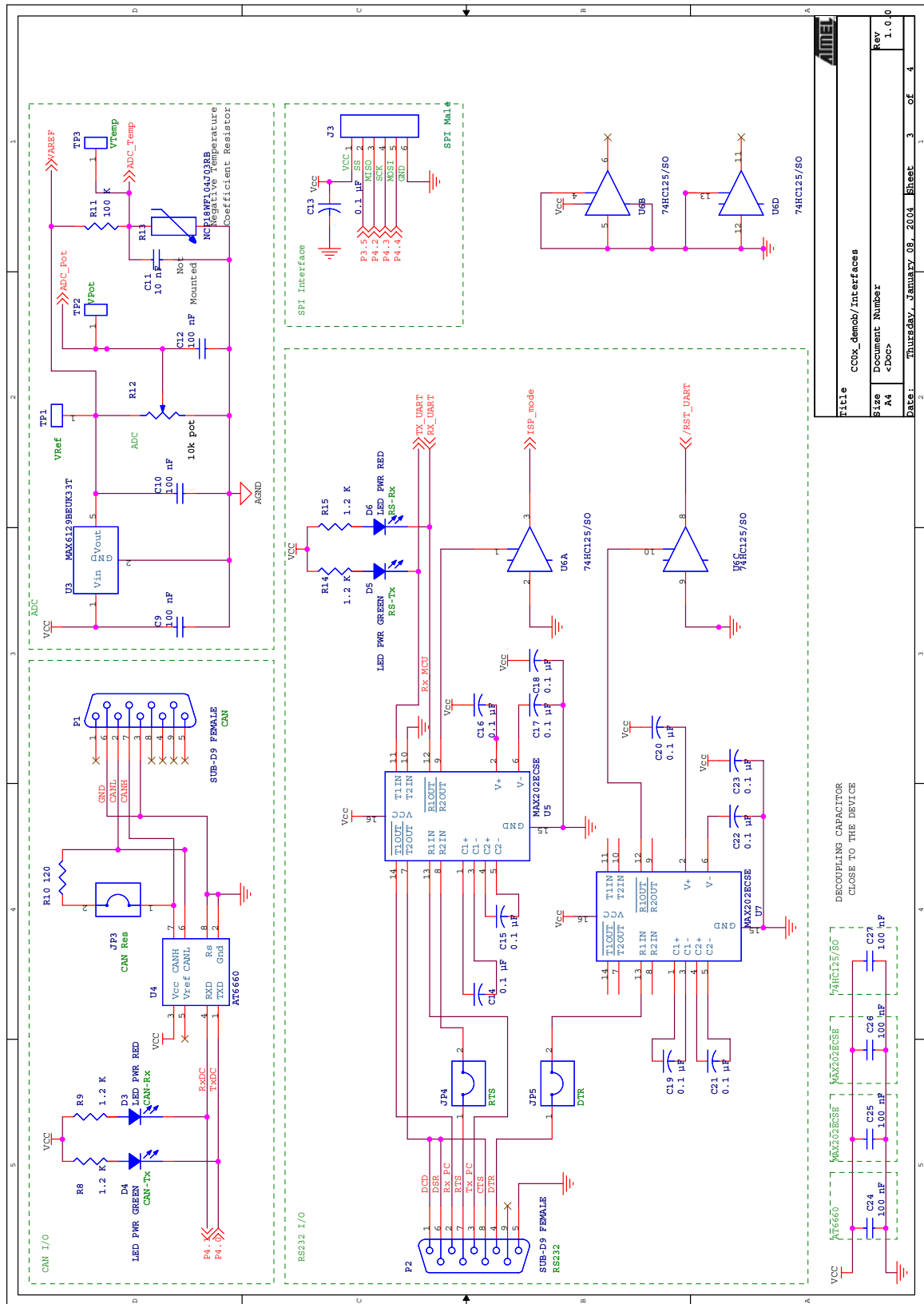
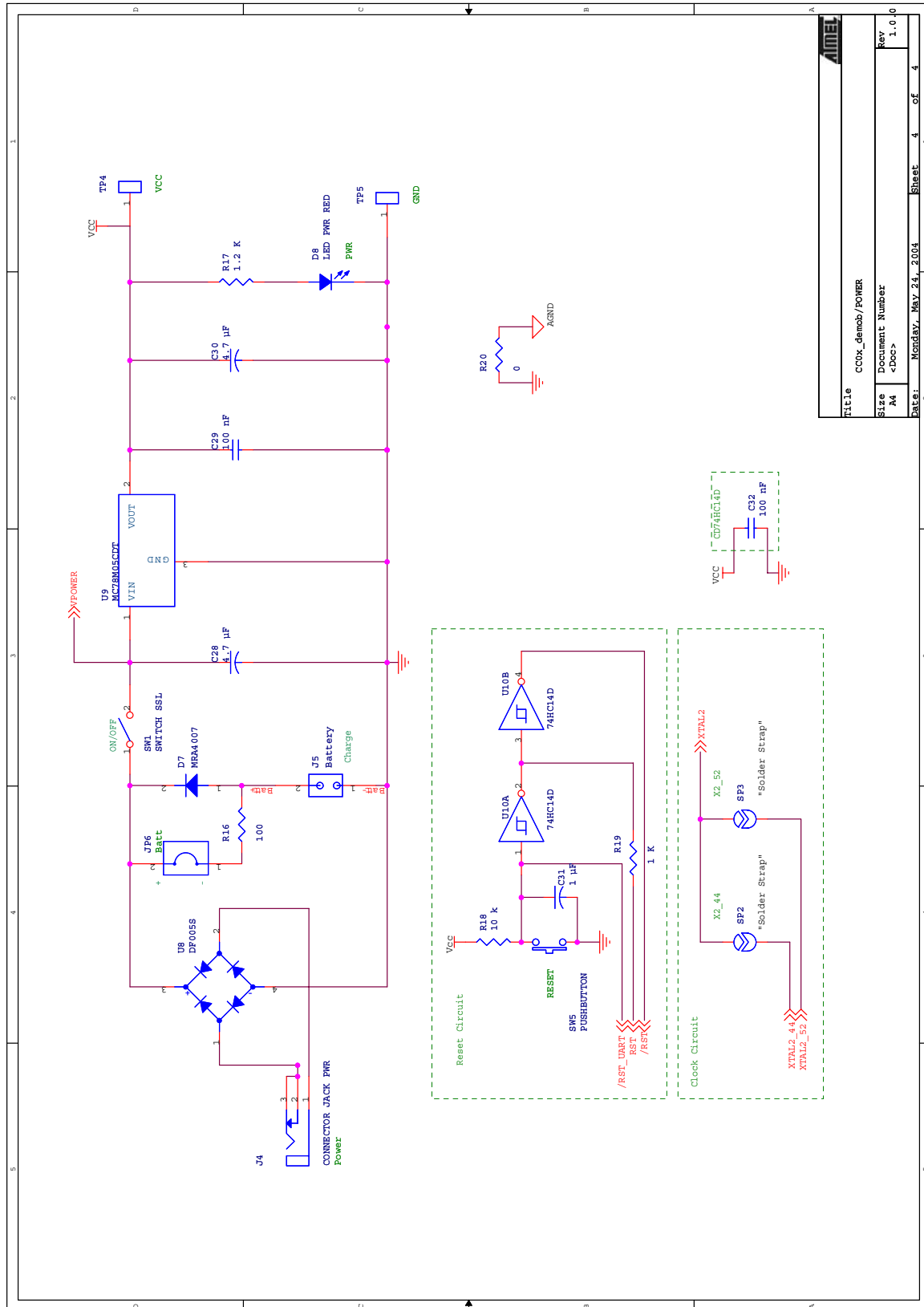

Figure 4-6. AT89STK-06 Board Schematics (4 of 4)



ATMEL	
Title	CC0x_demoB/POWER
Size	Document Number
44	<Doc>
Date:	Monday, May 24, 2004
Sheet:	4 of 4
Rev	1.0

# Appendix D: Default Configuration

Table 1. Default Configuration

Reference	Name	Function	State
SP1	CC02 mode	For T89C51CC02/T89C5115 usage, allow to redirect the ISP signal to P1.0, for hardware conditions.	Open
SP2	X2_44	Connect PLCC44 Xtal2 to XTAL2 of the generic extension board	Open
SP3	X2_52	Connect PLCC52 Xtal2 to XTAL2 of the generic extension board	Open
JP1	EA	ON : allows external execution OFF: Internal code execution	Open (OFF)
JP2	MUTE	ON : Enable C51 generic extension board buzzer OFF: Disable C51 generic extension board buzzer	Open (OFF)
JP3	CANRes	ON : Enable CAN terminator resistor OFF: Disable CAN terminator resistor	Open (OFF)
JP4	RTS	ON : Enable RTS line to control ISP mode OFF: Disable RTS line to control ISP mode	Open (OFF)
JP5	DTR	ON : Enable DTR line to drive MCU reset OFF: Disable DTR line to drive MCU reset	Open (OFF)
JP6	Batt	ON : Enable Battery charge OFF: Disable Battery charge	Open (OFF)

# Appendix E: References/Acronyms

- 
- 4.1 References**
- AT89C51CC03, T89C51CC02, T89C51CC01, T89C5115, AT89C51AC3, T89C51AC2 Product Datasheets\*

- 
- 4.2 Acronyms**
- API: Application Programming Interface
  - FLIP: FLeXible In-system Programming
  - HPC: High Pin Count microcontroller (by opposition to LPC)
  - ISP: In-System Programming
  - LPC: Low Pin Count microcontroller



## Atmel Headquarters

### Corporate Headquarters

2325 Orchard Parkway  
San Jose, CA 95131  
TEL 1(408) 441-0311  
FAX 1(408) 487-2600

### Europe

Atmel Sarl  
Route des Arsenaux 41  
Case Postale 80  
CH-1705 Fribourg  
Switzerland  
TEL (41) 26-426-5555  
FAX (41) 26-426-5500

### Asia

Room 1219  
Chinachem Golden Plaza  
77 Mody Road Tsimhatsui  
East Kowloon  
Hong Kong  
TEL (852) 2721-9778  
FAX (852) 2722-1369

### Japan

9F, Tonetsu Shinkawa Bldg.  
1-24-8 Shinkawa  
Chuo-ku, Tokyo 104-0033  
Japan  
TEL (81) 3-3523-3551  
FAX (81) 3-3523-7581

## Atmel Operations

### Memory

2325 Orchard Parkway  
San Jose, CA 95131  
TEL 1(408) 441-0311  
FAX 1(408) 436-4314

### Microcontrollers

2325 Orchard Parkway  
San Jose, CA 95131  
TEL 1(408) 441-0311  
FAX 1(408) 436-4314

La Chantrerie  
BP 70602  
44306 Nantes Cedex 3, France  
TEL (33) 2-40-18-18-18  
FAX (33) 2-40-18-19-60

### ASIC/ASSP/Smart Cards

Zone Industrielle  
13106 Rousset Cedex, France  
TEL (33) 4-42-53-60-00  
FAX (33) 4-42-53-60-01

1150 East Cheyenne Mtn. Blvd.  
Colorado Springs, CO 80906  
TEL 1(719) 576-3300  
FAX 1(719) 540-1759

Scottish Enterprise Technology Park  
Maxwell Building  
East Kilbride G75 0QR, Scotland  
TEL (44) 1355-803-000  
FAX (44) 1355-242-743

### RF/Automotive

Theresienstrasse 2  
Postfach 3535  
74025 Heilbronn, Germany  
TEL (49) 71-31-67-0  
FAX (49) 71-31-67-2340

1150 East Cheyenne Mtn. Blvd.  
Colorado Springs, CO 80906  
TEL 1(719) 576-3300  
FAX 1(719) 540-1759

### Biometrics/Imaging/Hi-Rel MPU/ High Speed Converters/RF Data- com

Avenue de Rochepleine  
BP 123  
38521 Saint-Egreve Cedex, France  
TEL (33) 4-76-58-30-00  
FAX (33) 4-76-58-34-80

---

### e-mail

[literature@atmel.com](mailto:literature@atmel.com)

### Web Site

<http://www.atmel.com>

**Disclaimer:** The information in this document is provided in connection with Atmel products. No license, express or implied, by estoppel or otherwise, to any intellectual property right is granted by this document or in connection with the sale of Atmel products. **EXCEPT AS SET FORTH IN ATMEL'S TERMS AND CONDITIONS OF SALE LOCATED ON ATMEL'S WEB SITE, ATMEL ASSUMES NO LIABILITY WHATSOEVER AND DISCLAIMS ANY EXPRESS, IMPLIED OR STATUTORY WARRANTY RELATING TO ITS PRODUCTS INCLUDING, BUT NOT LIMITED TO, THE IMPLIED WARRANTY OF MERCHANTABILITY, FITNESS FOR A PARTICULAR PURPOSE, OR NON-INFRINGEMENT. IN NO EVENT SHALL ATMEL BE LIABLE FOR ANY DIRECT, INDIRECT, CONSEQUENTIAL, PUNITIVE, SPECIAL OR INCIDENTAL DAMAGES (INCLUDING, WITHOUT LIMITATION, DAMAGES FOR LOSS OF PROFITS, BUSINESS INTERRUPTION, OR LOSS OF INFORMATION) ARISING OUT OF THE USE OR INABILITY TO USE THIS DOCUMENT, EVEN IF ATMEL HAS BEEN ADVISED OF THE POSSIBILITY OF SUCH DAMAGES.** Atmel makes no representations or warranties with respect to the accuracy or completeness of the contents of this document and reserves the right to make changes to specifications and product descriptions at any time without notice. Atmel does not make any commitment to update the information contained herein. Unless specifically provided otherwise, Atmel products are not suitable for, and shall not be used in, automotive applications. Atmel's products are not intended, authorized, or warranted for use as components in applications intended to support or sustain life.

© Atmel Corporation 2005. All rights reserved. Atmel®, logo and combinations thereof, Everywhere You Are® and others, are registered trademarks or trademarks of Atmel Corporation or its subsidiaries. Other terms and product names may be trademarks of others.



Printed on recycled paper.