



## Features

- Two channel quadrature output
- Bushing or servo mount
- Square wave signal
- Small size
- Resolution to 256 PPR
- CMOS and TTL compatible
- Long life
- Ball bearing option for high operating speed up to 3000 rpm
- RoHS compliant\*

## EN - Rotary Optical Encoder

### Electrical Characteristics

Output	2-bit quadrature code, Channel A leads Channel B by 90° (electrical) with clockwise rotation
Resolution	25 to 256 cycles per revolution
Insulation Resistance (500 VDC)	1,000 megohms
Electrical Travel	Continuous
Supply Voltage	5.0 VDC ±0.25 VDC
Supply Current	26 mA maximum
Output Voltage	
Low Output	0.8 V maximum
High Output	4 V minimum
Output Current	
Low Output	25 mA minimum
Rise/Fall Time	200 ns (typical)
Shaft RPM (Ball Bearing)	3,000 rpm maximum
Power Consumption	136 mW maximum
Pulse Width (Electrical Degrees, Each Channel)	180° ±45° typ.
Pulse Width (Index Channel)	360° ±90°
Phase (Electrical Degrees, Channel A to Channel B)	90° ±45° typ.

### Environmental Characteristics

Operating Temperature Range	-40 °C to +75 °C (-40 °F to +167 °F)
Storage Temperature Range	-40 °C to +85 °C (-40 °F to +185 °F)
Humidity	MIL-STD-202, Method 103B, Condition B
Vibration	5 G
Shock	50 G
Rotational Life	
A & C Bushings (300 rpm maximum)**	10,000,000 revolutions
W, S & T Bushings (3,000 rpm maximum)**	200,000,000 revolutions
IP Rating	IP 40

### Mechanical Characteristics

Mechanical Angle	360° Continuous
Torque (Starting and Running)	
A & C Bushings (Spring Loaded for Optimum Feel)	1 N-cm (1.5 oz-in.) maximum
W, S & T Bushings (Ball Bearing Shaft Support)	0.07 N-cm (0.1 oz-in.) maximum
Mounting Torque	1.7 to 2.0 N-m (15 to 18 lb.-in.) maximum
Shaft End Play	0.30 mm (0.012") T.I.R. maximum
Shaft Radial Play	0.12 mm (0.005") T.I.R. maximum
Weight	11 gms. (0.4 oz.)
Terminals	Axial or radial pc pins or ribbon cable
Soldering Condition	
Manual Soldering	96.5Sn/3.0Ag/0.5Cu solid wire or no-clean rosin cored wire 370 °C (700 °F) max. for 3 seconds
Wave Soldering	96.5Sn/3.0Ag/0.5Cu solder with no-clean flux 260 °C (500 °F) max. for 5 seconds
Wash processes	Not recommended
Marking	Manufacturer's trademark, name, part number, and date code.
Hardware	One lockwasher and one mounting nut supplied with each encoder, except on servo mount versions.

\*\*For resolutions ≤ 128 quadrature cycles per shaft revolution.

### Quadrature Output Table

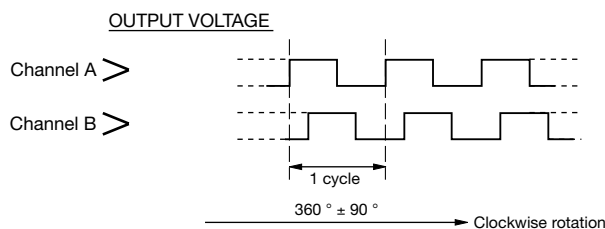

#### STANDARD RESOLUTIONS AVAILABLE

(Full quadrature output cycles per shaft revolution)	
25*	125
50*	128
64	200
100	256

For Non-Standard Resolutions—Consult Factory

\* Channel B leads Channel A

\*RoHS Directive 2002/95/EC Jan. 27, 2003 including annex and RoHS Recast 2011/65/EU June 8, 2011.

Specifications are subject to change without notice.

The device characteristics and parameters in this data sheet can and do vary in different applications and actual device performance may vary over time.

Users should verify actual device performance in their specific applications.

# EN - Rotary Optical Encoder

## Dimensional Drawings

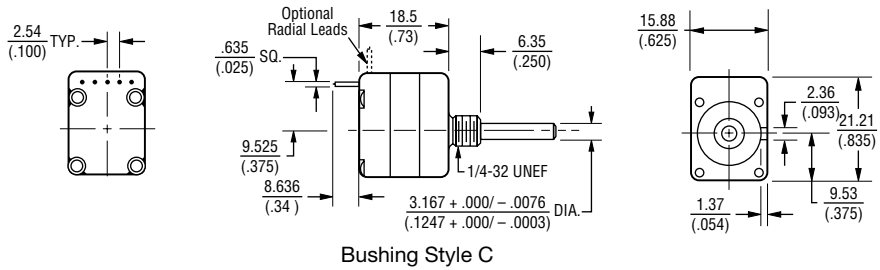

Consult factory for options not shown, including:

- Wire lead or cable options
- Connectors
- Non-standard resolutions
- Special shaft/bushing sizes and features
- Special performance characteristics
- PCB mounting bracket

Bushing Style C

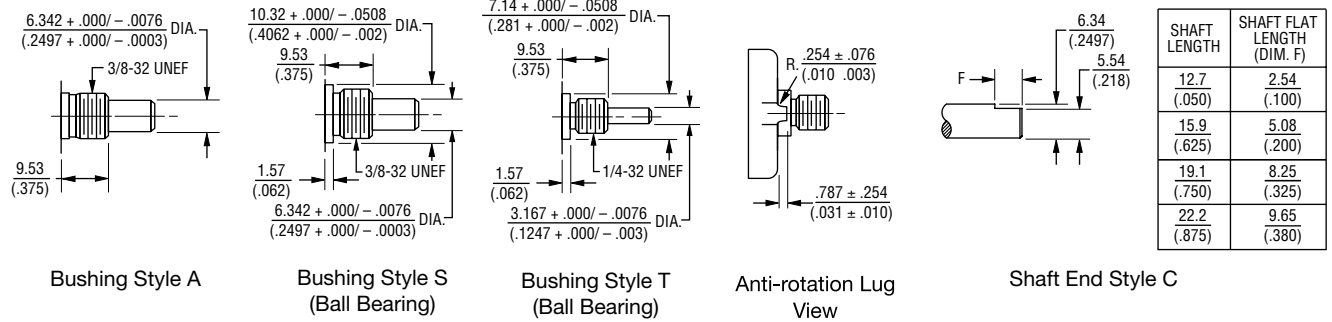

## TERMINATION DIAGRAM

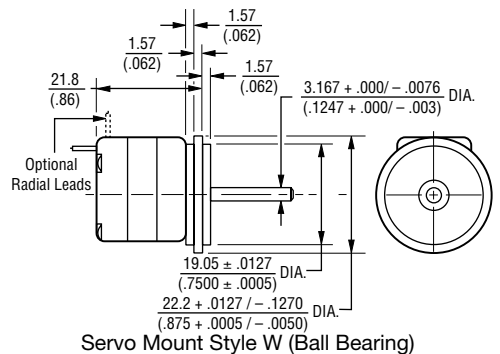
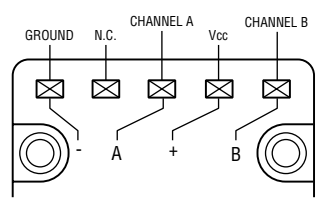

Servo Mount Style W (Ball Bearing)

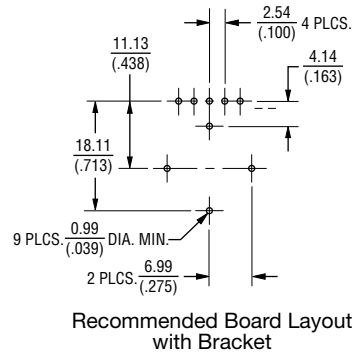

Recommended Board Layout with Bracket

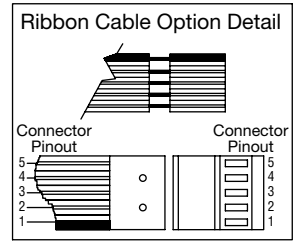
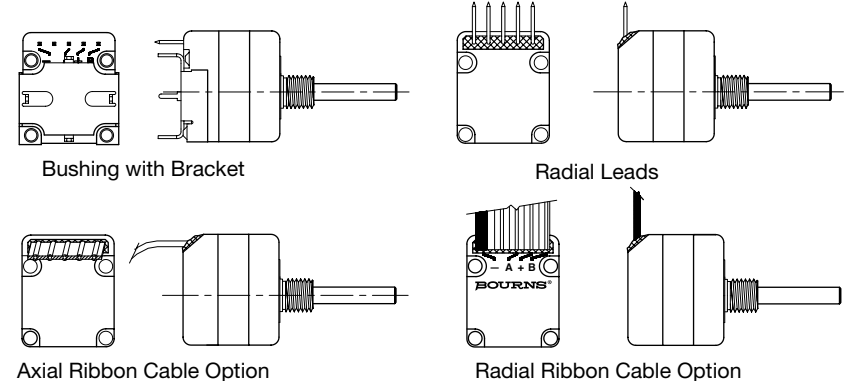

DIMENSIONS:  $\frac{\text{MM}}{\text{(INCHES)}}$

Specifications are subject to change without notice. The device characteristics and parameters in this data sheet can and do vary in different applications and actual device performance may vary over time. Users should verify actual device performance in their specific applications.

**GENERAL INFORMATION**

The Bourns® EN model is a self-contained rotary optical encoder. It produces a 2-bit quadrature signal which is suitable for digital systems where both magnitude and direction of adjustment must be provided. The EN encoder is ideal for use as a digital panel control or as a position sensing device in applications where long life, reliability, high resolution and precise linearity are critical.

The EN series encoder converts rotary input into electrical signals which can be used by microprocessors without A/D conversion.

Bourns encoder output signals are square wave digital pulses which do not require debounce circuitry. Both features make it possible to significantly reduce the memory overhead, wiring and wiring interconnects required by other types of control devices.

EN optical encoders offer a useful rotational life of from 10 million to 200 million shaft revolutions, making them ideal for extended service applications. The Bourns encoder is also compact and well suited for situations where the available space is limited.

# EN - Rotary Optical Encoder BOURNS®

## How To Order

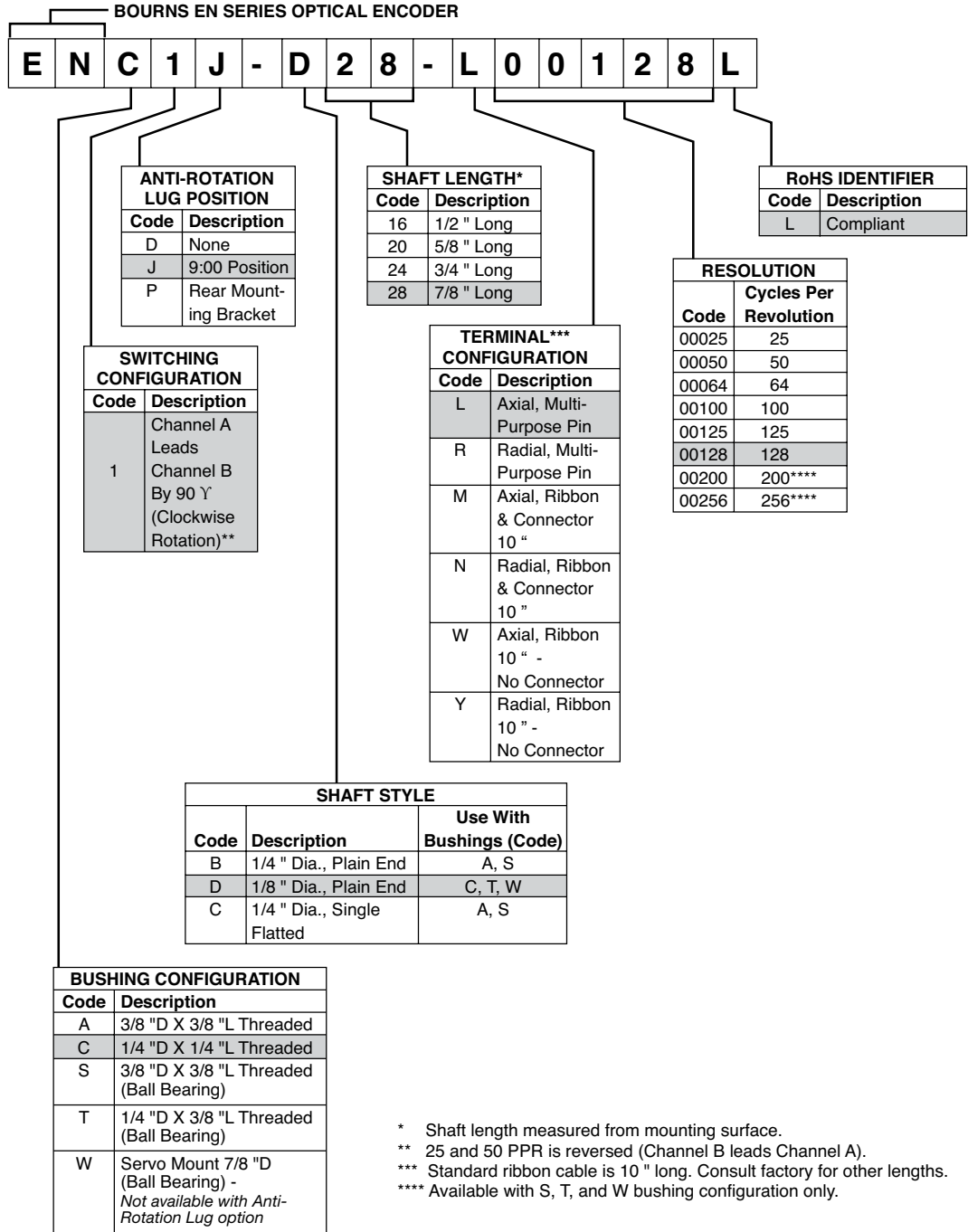

\* Shaft length measured from mounting surface.

\*\* 25 and 50 PPR is reversed (Channel B leads Channel A).

\*\*\* Standard ribbon cable is 10 " long. Consult factory for other lengths.

\*\*\*\* Available with S, T, and W bushing configuration only.