

\*RoHS COMPLIANT

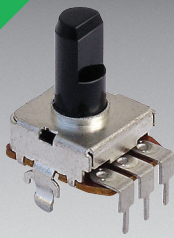

**BOURNS®**

## Features

- Single gang panel control
- RoHS compliant\*
- Carbon element
- Center detent option
- Wide range of resistance tapers
- Insulated shaft styles
- Assortment of pin layouts

## Applications

- Audio/TV sets
- Car radio
- Amplifiers/mixers/drum machines/synthesizers
- PCs/monitors
- Appliances

# PDB12 Series - 12 mm Rotary Potentiometer

### Electrical Characteristics

Taper..... Linear, audio  
 Standard Resistance Range  
 ..... 1K ohms to 1M ohms  
 Standard Resistance Tolerance..... ±20 %  
 Residual Resistance ..... 10 ohms max.

### Environmental Characteristics

Power Rating  
 Linear ..... 0.08 watt  
 Audio ..... 0.04 watt  
 Maximum Operating Voltage  
 Linear ..... 150 V  
 Audio ..... 100 V  
 Sliding Noise ..... 47 mV max.  
 Operating Temperature... -10 °C to +70 °C

### Mechanical Characteristics

Mechanical Angle ..... 300 ° ±5 °  
 Rotational Torque ..... 20 to 200 g-cm  
 Stop Strength ..... 3 kg-cm min.  
 Rotational Life ..... 15,000 cycles  
 Soldering Condition  
 ..... 300 °C max. within 3 seconds  
 Hardware ..... No hardware supplied

### Derating Curve

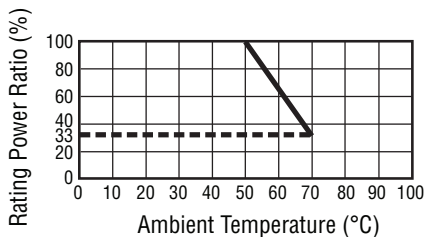

### Product Dimensions

PDB12-H

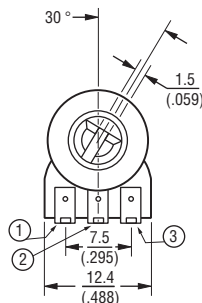
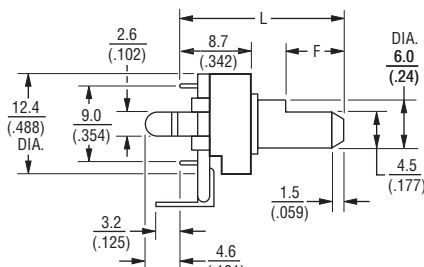

RECOMMENDED PCB LAYOUT

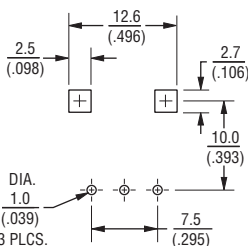

SHAFT SHOWN IN CCW POSITION

PDB12-G

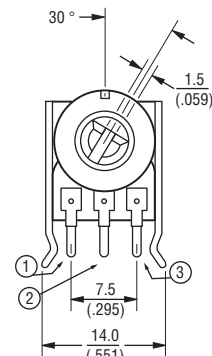
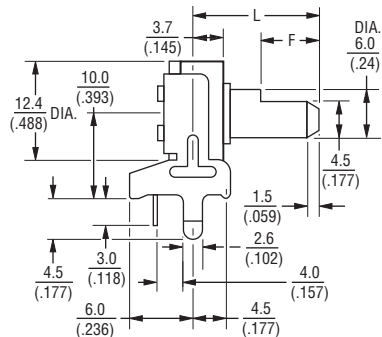

RECOMMENDED PCB LAYOUT

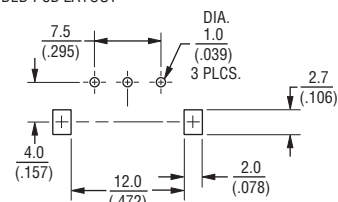

SHAFT SHOWN IN CCW POSITION

### PDB12 Dimensions

L	15 (.591)	20 (.787)	25 (.984)	30 (1.181)
F	7 (.276)	7 (.276)	12 (.472)	12 (.472)

DIMENSIONS:  $\frac{\text{MM}}{\text{(INCHES)}}$

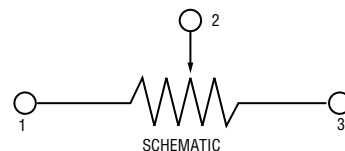

\*RoHS Directive 2002/95/EC Jan. 27, 2003 including annex and RoHS Recast 2011/65/EU June 8, 2011.

Specifications are subject to change without notice.

The device characteristics and parameters in this data sheet can and do vary in different applications and actual device performance may vary over time.

Users should verify actual device performance in their specific applications.

# PDB12 Series - 12 mm Rotary Potentiometer

**BOURNS®**

## Product Dimensions

### PDB12-M

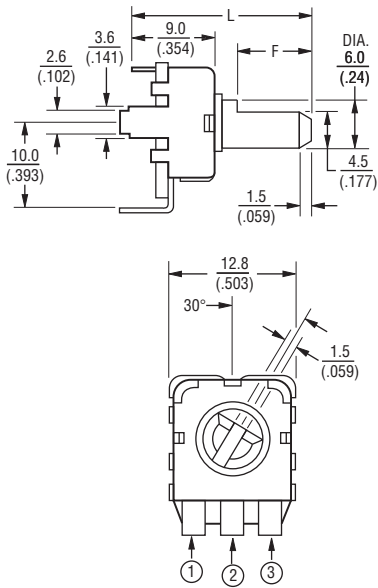

### RECOMMENDED PCB LAYOUT

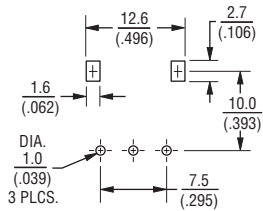

SHAFT SHOWN IN CCW POSITION

DIMENSIONS:  $\frac{\text{MM}}{\text{(INCHES)}}$

### PDB12-F

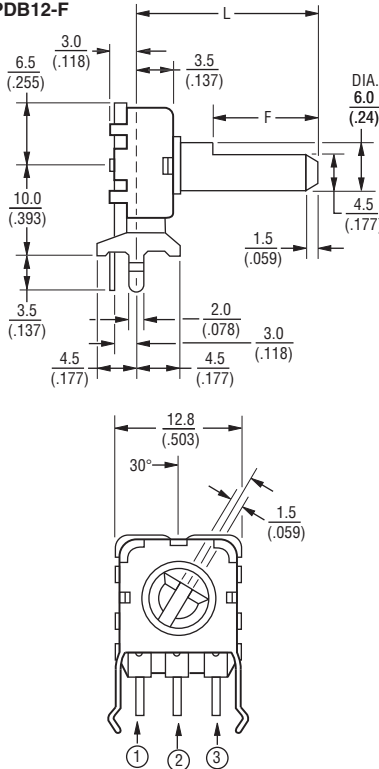

### RECOMMENDED PCB LAYOUT

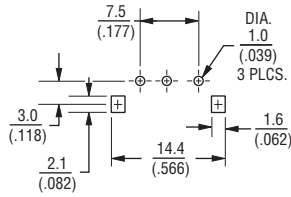

SHAFT SHOWN IN CCW POSITION

## How To Order

**PDB12 - H 4 20 1 - 103 A F**

- Model
- Terminal Config. (see individual drawings)  
 H = PC pins, rear facing snap mount  
 G = PC pins, vertical/down facing/ snap mount  
 M = PC pins, rear facing  
 F = PC pins, vertical/down facing/ snap mount
- Option  
 • 2 = Center Detent  
 • 4 = No Detent
- Standard Shaft Length  
 • 15 = 15 mm  
 • 20 = 20 mm  
 • 25 = 25 mm  
 • 30 = 30 mm
- Number of Gangs  
 • 1 = Single Gang
- Resistance Code (See Table)
- Resistance Taper  
 • A = Audio Taper  
 • B = Linear Taper
- Shaft Style  
 • F = Flat Type Insulated Shaft
- Other styles available.

## Standard Resistance Table

Resistance (Ohms)	Resistance Code
1,000	102
2,000	202
5,000	502
10,000	103
20,000	203
50,000	503
100,000	104
200,000	204
500,000	504
1,000,000	105

## PDB12 Dimensions

L	15 (.591)	20 (.787)	25 (.984)	30 (1.181)
F	7 (.276)	7 (.276)	12 (.472)	12 (.472)

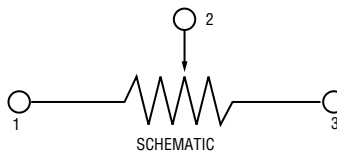

REV. 09/16

Specifications are subject to change without notice.

The device characteristics and parameters in this data sheet can and do vary in different applications and actual device performance may vary over time. Users should verify actual device performance in their specific applications.