

Features

- Carbon element
- Red, orange, green, amber and white LED colors
- Center detent option
- Assortment of resistance tapers
- Various travel lengths
- Various lever sizes



PTL Series Slide Potentiometer w/LED

Electrical Characteristics

Standard Resistance Range
1K ohms to 1 megohm
 Standard Resistance Tolerance.....±20 %
 End Resistance
 20 mm Travel 10 ohms max.
 30 mm Travel 20 ohms max.
 45 mm Travel 20 ohms max.
 60 mm Travel 30 ohms max.
 100 mm Travel 30 ohms max.
 Insulation Resistance @ 250 VDC
 100 megohms min.
 Dielectric Withstanding Voltage
300 VAC
 Standard Taper Linear, Audio
 Power Rating - Linear
 20 mm Travel 0.05 watt
 30 mm Travel 0.1 watt
 45 mm Travel 0.125 watt
 60 mm Travel 0.2 watt
 100 mm Travel 0.2 watt
 Power Rating - Audio
 20 mm Travel 0.025 watt
 30 mm Travel 0.05 watt
 45 mm Travel 0.06 watt
 60 mm Travel 0.1 watt
 100 mm Travel 0.1 watt
 Slider Noise200 mV max.

Environmental Characteristics

Operational Life 15,000 cycles
 TR Shift±15 %
 Operating Temperature Range
-10 °C to +55 °C
 Resistance to Solder Heat.....±5 %

Mechanical Characteristics

Mechanical Travel..... Length ±0.5 mm
 Operating Force..... 30 gf to 250 gf
 Center Detent Force 20 gf to 200 gf
 Stop Strength..... 5 kgf min.
 Shaft Axial Force 5 kgf min.
 Shaft Wobble ...2(2 x L/20) mm p-p max.
 Soldering Condition
 Manual 300 °C ±5 °C for 3 sec.
 Wave 260 °C ±5 °C for 5 sec.
 Wash Not recommended

Product Dimensions

20 mm Length of Travel

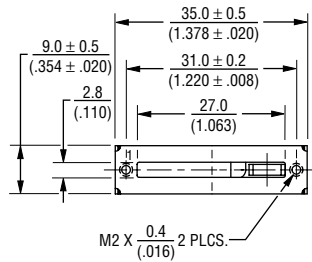

Lever Length
10.0 (.394)
15.0 (.591)
19.0 (.748)

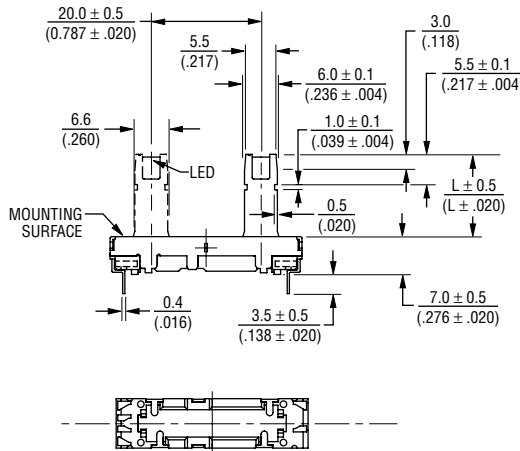

DIMENSIONS: $\frac{\text{MM}}{\text{(INCHES)}}$

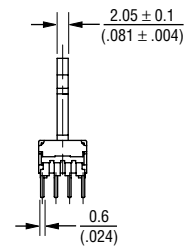

Mounting Hole Detail

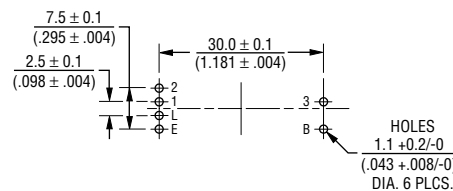

Standard Resistance Table

Resistance (Ohms)	Resistance Code
1,000	102
2,000	202
5,000	502
10,000	103
20,000	203
50,000	503
100,000	104
200,000	204
500,000	504
1,000,000	105

Schematic

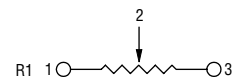

*RoHS Directive 2002/95/EC Jan. 27, 2003 including annex and RoHS Recast 2011/65/EU June 8, 2011.

Specifications are subject to change without notice.

The device characteristics and parameters in this data sheet can and do vary in different applications and actual device performance may vary over time.

Users should verify actual device performance in their specific applications.

Applications

- Mixing consoles
- Drum machines
- Keyboards and synthesizers
- Equalizers

PTL Series Slide Potentiometer w/LED

BOURNS®

Product Dimensions

30 mm Length of Travel

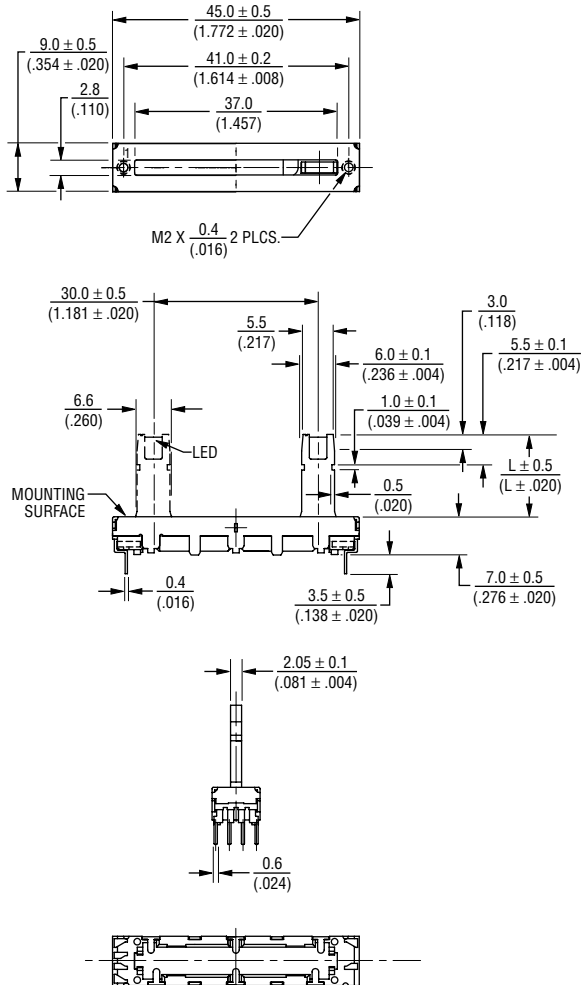

Mounting Hole Detail

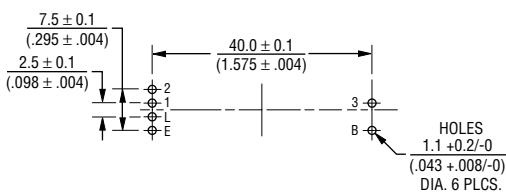

DIMENSIONS: $\frac{\text{MM}}{\text{(INCHES)}}$

45 mm Length of Travel

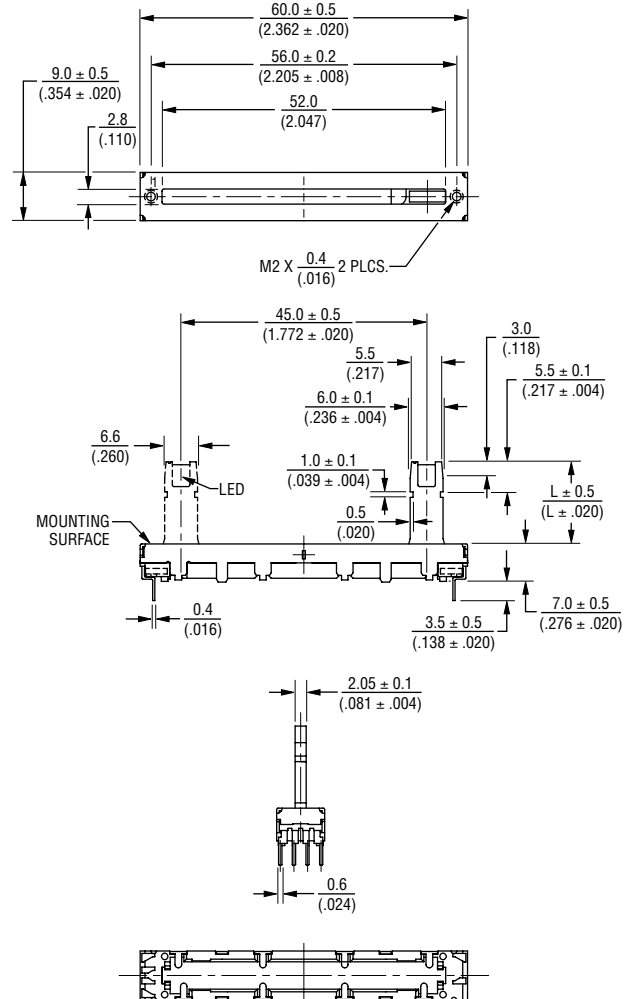

Mounting Hole Detail

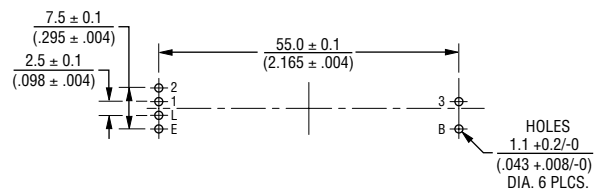

Specifications are subject to change without notice.

The device characteristics and parameters in this data sheet can and do vary in different applications and actual device performance may vary over time. Users should verify actual device performance in their specific applications.

PTL Series Slide Potentiometer w/LED

BOURNS®

Product Dimensions

60 mm Length of Travel

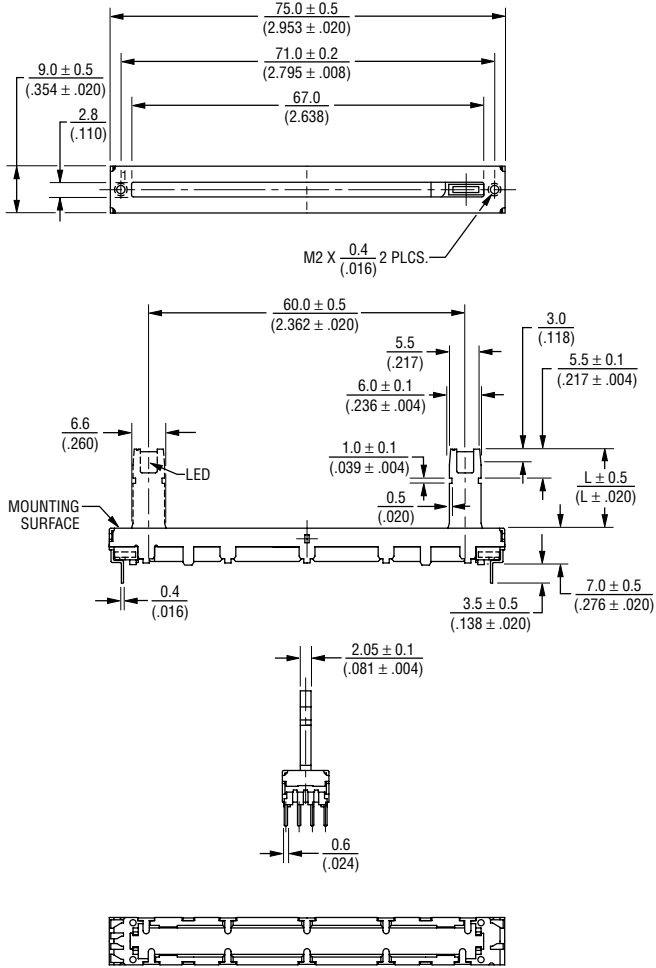

Mounting Hole Detail

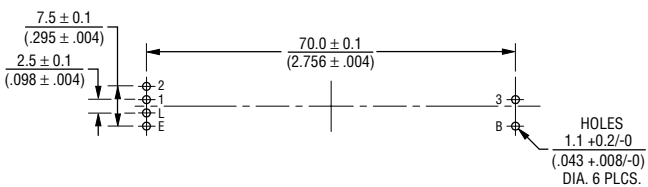

DIMENSIONS: $\frac{\text{MM}}{\text{(INCHES)}}$

100 mm Length of Travel

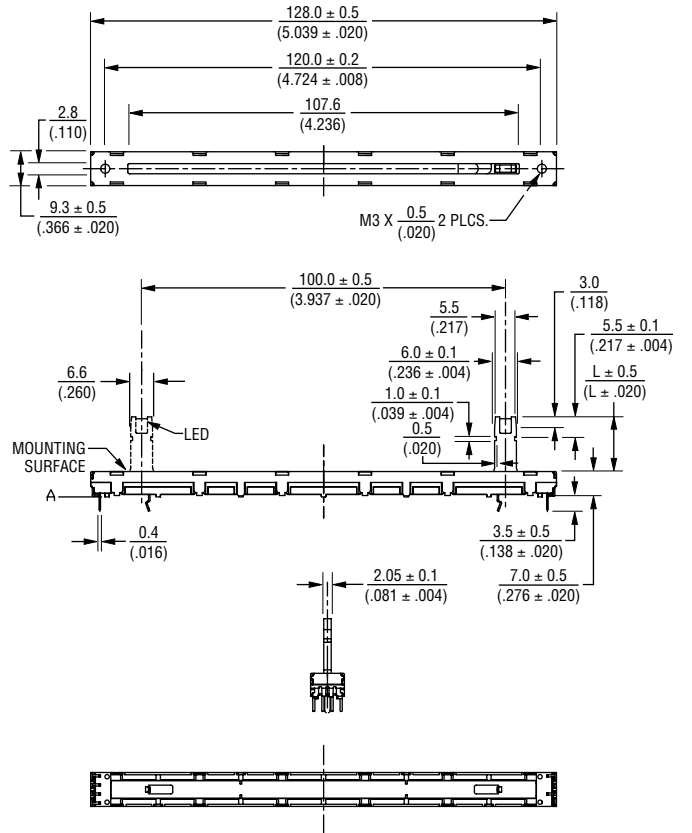

Mounting Hole Detail

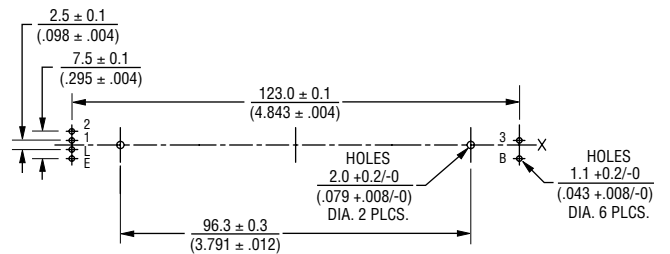

Specifications are subject to change without notice.

The device characteristics and parameters in this data sheet can and do vary in different applications and actual device performance may vary over time. Users should verify actual device performance in their specific applications.

PTL Series Slide Potentiometer w/LED



Tapers

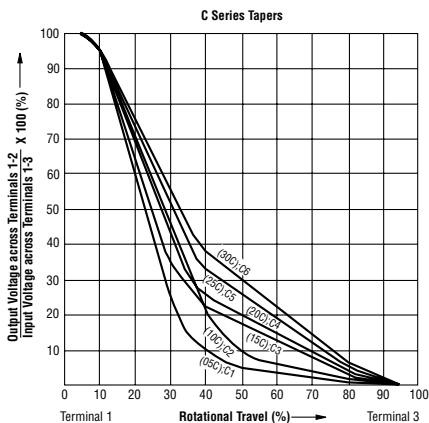
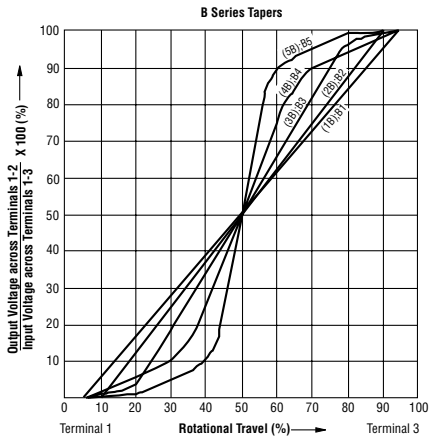
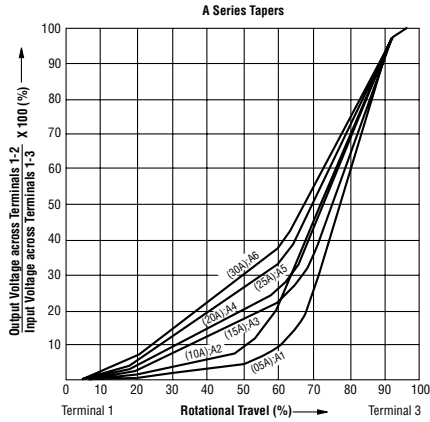

Circuit

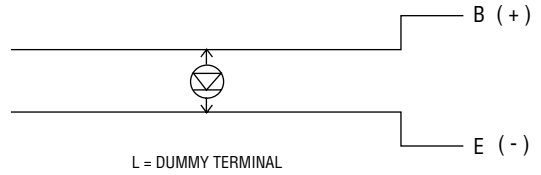

How To Order

PTL 30 - 10 R 0 - 103 B2

Model Number _____

Designator _____

PTL = Slide Potentiometer w/LED

Length of Travel _____

20 = 20 mm 45 = 45 mm 01 = 100 mm

30 = 30 mm 60 = 60 mm

Lever Length _____

10 = 10 mm

15 = 15 mm

19 = 19 mm

LED Color _____

R = Red A = Amber

O = Orange W = White

G = Green

Detent Option _____

0 = No Detent

1 = Center Detent

Resistance Code _____

(See Standard Resistance Table)

Resistance Taper (See Taper Charts) _____

Taper Series followed by Curve Number

PTL Series Slide Potentiometer w/LED

BOURNS®

LED Characteristics

Emitter Color	Item	Symbol	Test Conditions	Min.	Typ.	Max.	Unit
Red	Forward Voltage	V_F	$I_F = 20 \text{ mA}$		2.1	2.5	V
	Luminous Intensity	I_V		0.3	0.6		mcd
	Peak Emission Wavelength	λ_p			660		nm
	Dominant Wavelength	λ_d			643		nm
	Spectral Line Half Width	$\Delta\lambda$			20		nm
Orange	Forward Voltage	V_F	$I_F = 20 \text{ mA}$		2.2	2.5	V
	Luminous Intensity	I_V		1.5	3.0		mcd
	Peak Emission Wavelength	λ_p			610		nm
	Dominant Wavelength	λ_d			605		nm
	Spectral Line Half Width	$\Delta\lambda$			35		nm
Green	Forward Voltage	V_F	$I_F = 20 \text{ mA}$		2.1	2.5	V
	Luminous Intensity	I_V		0.6	1.2		mcd
	Peak Emission Wavelength	λ_p			530		nm
	Dominant Wavelength	λ_d			35		nm
	Spectral Line Half Width	$\Delta\lambda$			160		nm
Amber	Forward Voltage	V_F	$I_F = 20 \text{ mA}$		2.1	2.6	V
	Luminous Intensity	I_V			5.0		mcd
	Peak Emission Wavelength	λ_p			585		nm
	Dominant Wavelength	λ_d		582	–	595	nm
	Spectral Line Half Width	$\Delta\lambda$			35		nm
White	Forward Voltage	V_F	$I_F = 20 \text{ mA}$		3.5	4	V
	Luminous Intensity	I_V			300.0		mcd
	Peak Emission Wavelength	λ_p			520		nm
	Dominant Wavelength	λ_d		460	–	470	nm
	Spectral Line Half Width	$\Delta\lambda$			35		nm

REV. 01/17

Specifications are subject to change without notice.
 The device characteristics and parameters in this data sheet can and do vary in different applications and actual device performance may vary over time.
 Users should verify actual device performance in their specific applications.