



Features

- Shielded construction
- Inductance range: 4.7 to 100 μ H
- Heating current up to 5.5 A
- Dimensions: 10 x 10 x 6.5 mm
- AEC-Q200 qualified
- RoHS compliant* and halogen free**

Applications

- Automotive systems:
 - Driver assistant
 - Infotainment
 - Lighting
- DC/DC converters
- Power supplies

SRU1063A Series - Shielded Power Inductors

Electrical Specifications @ 25 °C

Bourns Part Number	Inductance @ 100 kHz / 0.1 V		Q Ref.	Test Freq. (MHz)	SRF Typ. (MHz)	DCR (Ω)		I rms (A)	I sat (A)
	L (μ H)	Tol. (%)				Typ.	Max.		
SRU1063A-4R7Y	4.7	± 30	11	7.96	30	0.011	0.014	5.5	5.7
SRU1063A-6R8Y	6.8	± 30	11	7.96	20	0.0145	0.018	5.2	5.2
SRU1063A-100Y	10	± 30	14	2.52	18	0.027	0.038	3.8	4.0
SRU1063A-150Y	15	± 30	12	2.52	14	0.03	0.042	3.2	3.4
SRU1063A-220Y	22	± 30	15	2.52	10	0.043	0.06	3.0	3.2
SRU1063A-330Y	33	± 30	12	2.52	8	0.075	0.105	2.2	2.4
SRU1063A-470Y	47	± 30	10	2.52	6	0.105	0.15	1.4	1.6
SRU1063A-680Y	68	± 30	8	2.52	5	0.15	0.21	1.2	1.35
SRU1063A-101Y	100	± 30	12	0.796	4	0.24	0.32	1.1	1.2

How to Order

SRU1063A - 100Y

Model _____
Value Code (see table) _____

Electrical Schematic

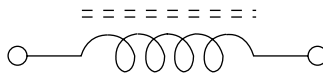

Soldering Profile

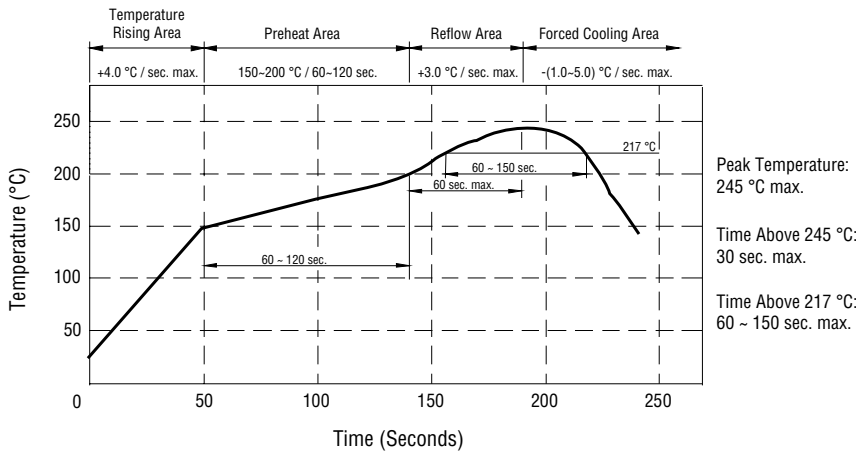

General Specifications

Operating Temperature-40 °C to +125 °C
(Temperature rise included)

Storage Temperature...-40 °C to +125 °C
Temperature Rise 40 °C typ. at rated I rms

Inductance drop..... 35 % at I sat

Failure In Time (FIT).....24.7/10⁹ hours

Mean Time Between Failures (MTBF) 40.4 x 10⁶ hours

Materials

Core..... Ferrite

Wire..... Enameled copper

Terminal..... Sn

Packaging 500 pcs. per reel

Product Dimensions

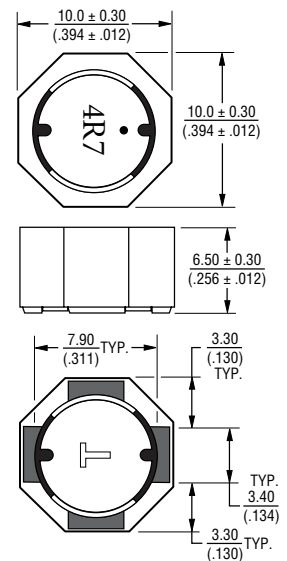

Recommended Layout

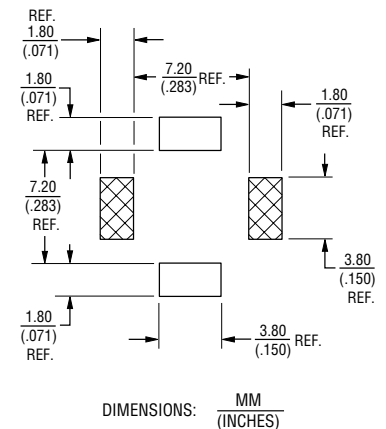

*RoHS Directive 2002/95/EC Jan. 27, 2003 including annex and RoHS Recast 2011/65/EU June 8, 2011.

**Bourns considers a product to be "halogen free" if (a) the Bromine (Br) content is 900 ppm or less; (b) the Chlorine (Cl) content is 900 ppm or less; and (c) the total Bromine (Br) and Chlorine (Cl) content is 1500 ppm or less.

Specifications are subject to change without notice.

The device characteristics and parameters in this data sheet can and do vary in different applications and actual device performance may vary over time.

Users should verify actual device performance in their specific applications.

SRU1063A Series - Shielded Power Inductors



Inductance vs. IDC

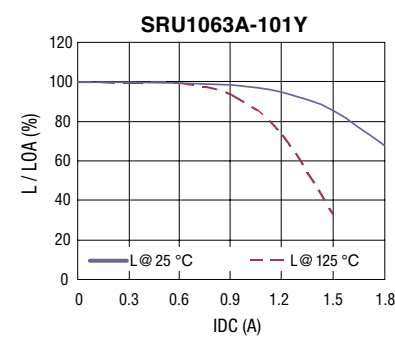
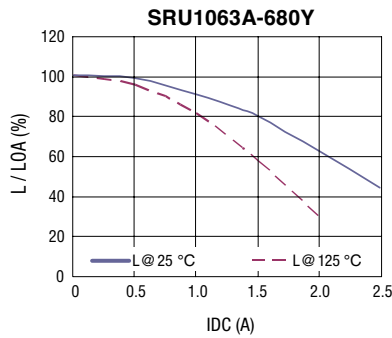
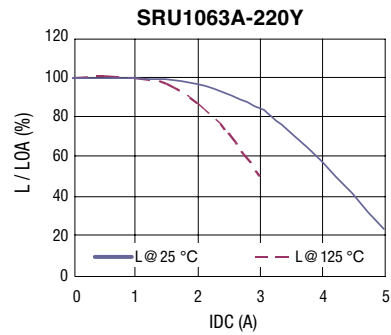
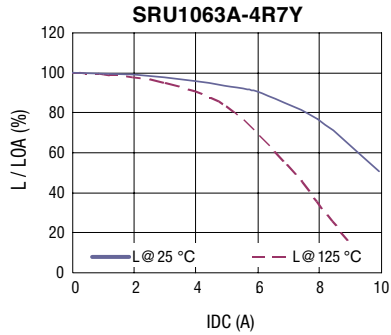

Temperature vs. IDC

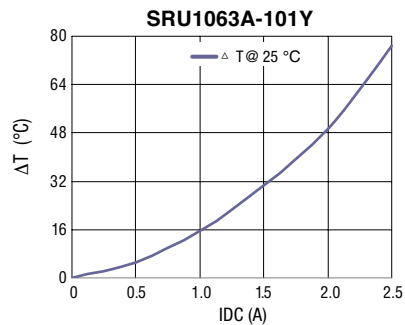
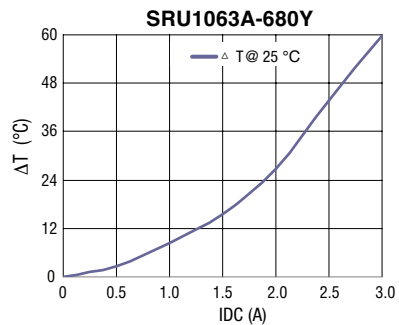
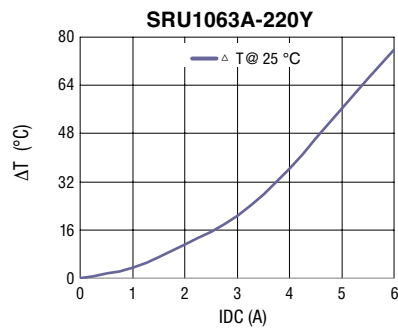
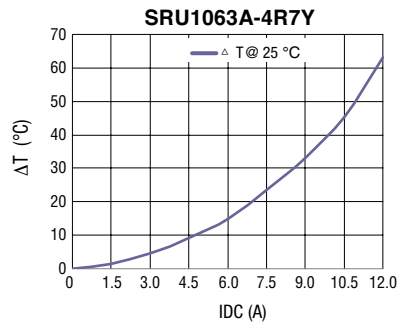

Specifications are subject to change without notice.
 The device characteristics and parameters in this data sheet can and do vary in different applications and actual device performance may vary over time.
 Users should verify actual device performance in their specific applications.

SRU1063A Series - Shielded Power Inductors

BOURNS®

Packaging Specifications

