

# 3 Series Thumbwheel Switches

## Features/Benefits

- Most complete product offering in the industry
- Spacers available to fit most panel cutouts
- Front or rear mounting options

## Typical Applications

- Test & measurement equipment
- Industrial equipment
- Computer devices



## Specifications

CONTACT RATING:  
 CARRY: 1 AMP continuous.  
 SWITCH: 100 mA max.

OPERATING VOLTAGE: 50 mV to 28 V DC or 120 V AC.  
 ELECTRICAL LIFE: 100,000 actuations.  
 CONTACT RESISTANCE: Below 100 m Ω typ. initial @  
 2-4 V DC, 100 mA.

INSULATION RESISTANCE: 10<sup>9</sup> Ω min.  
 DIELECTRIC STRENGTH: 500 Vrms min. @ sea level  
 between common terminal and any output.  
 OPERATING TEMPERATURE: -40°C to 65°C.

## Materials

HOUSING: ABS plastic.  
 THUMBWHEEL: ABS plastic.  
 ROTOR CONTACTS: Precious metal on copper alloy.  
 STATOR CONTACTS: Hard gold over nickel over copper  
 on epoxy fiberglass.

**NOTE:** Specifications and materials listed above are for switches with standard options  
 For information on specific and custom switches, consult Customer Service Center.

\* Note: All models listed are RoHS compliant. See Technical Data section of this catalog for  
 RoHS compliant and compatible definitions and specifications.

## Build-A-Switch

To order, simply select desired option from each category and place in the appropriate box. Available options are shown and described on pages M-4 thru M-10. For additional options not shown in catalog, consult Customer Service Center. Consult factory for illumination availability.

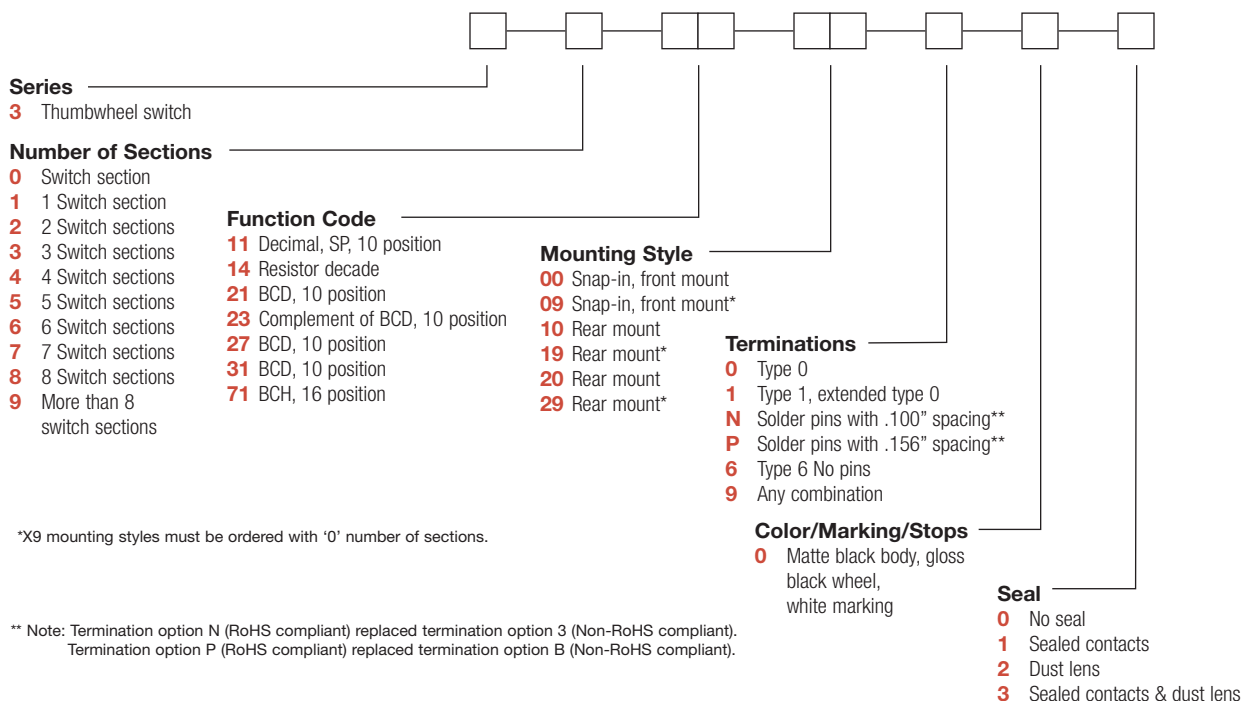

Thumbwheel



M

# 3 Series Thumbwheel Switches

## SERIES

### 3 THUMBWHEEL SWITCHES

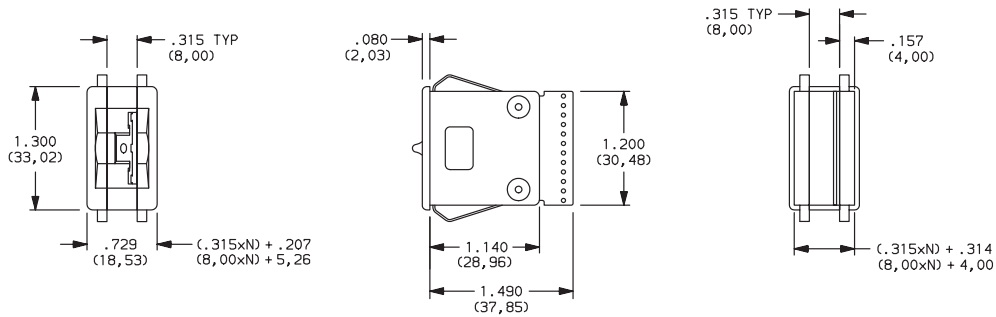

## NUMBER OF SECTIONS

- 0 Switch section only, no assembly. Blank bodies are considered sections; endplates are not sections. Must be ordered with 09 or 19 mounting style options, see pages M-5 and M-6.
- 1-8 Number of switch sections in assembly, includes endplates.
- 9 More than 8 switch sections, specify on CONFIGURATION FORM, page M-10 and consult Customer Service Center.

**NOTE:** Endplates and blank sections available separately, see pages M-13 and M-14.

## FUNCTION CODE

- 11 DECIMAL-1 POLE; 10 POSITION
- 14 RESISTOR DECADE; 1-2-2-2-2 CODE (RESISTORS NOT SUPPLIED)
- 21 BCD 1-2-4-8; 10 POSITION

W H E E L	SIGNALS CONNECTED TO COMMON SIGNAL C										C
	0	1	2	3	4	5	6	7	8	9	
0	●										●
1		●									●
2			●								●
3				●							●
4					●						●
5						●					●
6							●				●
7								●			●
8									●		●
9										●	●
	2	3	4	5	6	7	8	9	10	11	12
	TERM. LOCATION										

Available Terminations: 0, 1, N  
See fig. 1, page M-7.

W H E E L	SWITCH CIRCUIT									
	0	1	2	3	4	5	6	7	8	9
0	●	●	●	●	●	●	●	●	●	●
1	●	●	●	●	●	●	●	●	●	●
2	●	●	●	●	●	●	●	●	●	●
3	●	●	●	●	●	●	●	●	●	●
4	●	●	●	●	●	●	●	●	●	●
5	●	●	●	●	●	●	●	●	●	●
6	●	●	●	●	●	●	●	●	●	●
7	●	●	●	●	●	●	●	●	●	●
8	●	●	●	●	●	●	●	●	●	●
9	●	●	●	●	●	●	●	●	●	●
	11	9	7	5	3	1,2	1,2			
	TERM. LOCATION									

Available Terminations: 1  
See fig. 1, page M-7.

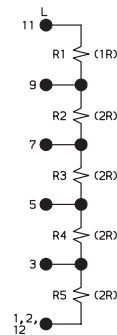

W H E E L	SIGNALS CONN. TO COMMON SIG. C				
	1	2	4	8	C
0					●
1	●				●
2		●			●
3			●		●
4				●	●
5					●
6					●
7					●
8					●
9					●
	3	5	7	11	9
	TERM. LOCATION				

Available Terminations: 0, 1, N  
See fig. 1, page M-7.

**NOTE:** For terminal location diagram, see page M-7.

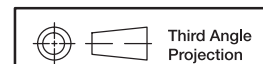

Dimensions are shown: Inches (mm)  
Specifications and dimensions subject to change



# 3 Series Thumbwheel Switches

## FUNCTION CODE

**23** COMPLEMENT OF BCD 1-2-4-8;  
10 POSITION

W H E E L	SIGNALS CONN. TO COMM. SIG. C			
	1	2	4	8
0	●	●	●	●
1	●	●	●	●
2	●	●	●	●
3	●	●	●	●
4	●	●	●	●
5	●	●	●	●
6	●	●	●	●
7	●	●	●	●
8	●	●	●	●
9	●	●	●	●
	3	9	11	5
TERM. LOCATION				

Available Terminations: 0, 1, N  
See fig. 1, page M-7.

**27** BCD 1-2-4-8; 10 POSITION

W H E E L	SIGNALS CONN. TO COMM. SIG. C			
	1	2	4	8
0				●
1	●			●
2		●		●
3	●	●		●
4			●	●
5	●			●
6		●	●	●
7	●	●	●	●
8			●	●
9	●			●
	4	5	1	2
TERM. LOCATION				

Available Terminations: P  
See fig. 2, page M-7.

**31** BCD 1-2-4-8; 10 POSITION

W H E E L	SIGNALS CONN. TO COMM. SIG. C			
	1	2	4	8
0				●
1	●			●
2		●		●
3	●	●		●
4			●	●
5	●			●
6		●	●	●
7	●	●	●	●
8			●	●
9	●			●
	2	3	11	9
TERM. LOCATION				

Available Terminations: 0, 1, N  
See fig. 1, page M-7.

**71** BINARY CODED HEXADECIMAL,  
16 POSITION

W H E E L	SIGNALS CONN. TO COMM. SIG. C			
	1	2	4	8
0				●
1	●			●
2		●		●
3	●	●		●
4			●	●
5	●			●
6		●	●	●
7	●	●	●	●
8			●	●
9	●			●
A	●	●	●	●
B	●	●	●	●
C		●	●	●
D	●	●	●	●
E	●	●	●	●
F	●	●	●	●
	3	5	7	11
TERM. LOCATION				

Available Terminations: 0, 1, N  
See fig. 1, page M-7.

**NOTE:** For terminal location diagram, see page M-7.

## MOUNTING STYLE

### Type 0 Snap-In Front Mount

MOUNTING STYLE	DIM. 'A'
00	$(.315 \times N) + .326$ $(8,00 \times N) + (8,28)$

N = Number of sections.

Recommended panel thickness:  
0.46-.125  
(1,16-3,18)

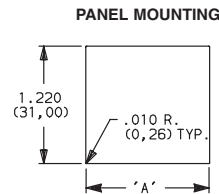

**00** SWITCH ASSEMBLY W/ ENDPLATES—.315 (8,00) SECTION PITCH

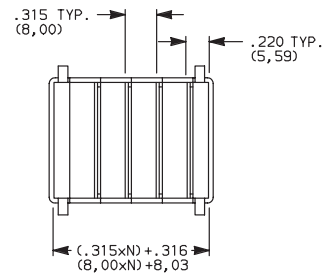
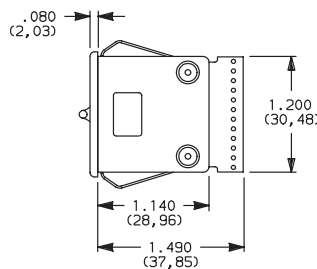
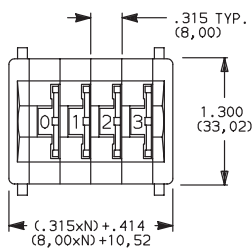

N = Number of sections.

**09** SWITCH SECTION ONLY—UNASSEMBLED WITHOUT ENDPLATES OR SPACERS  
(Must be ordered with number of sections option "0", see Page M-4.)

**NOTE:** Endplates, blank sections, spacers  
and assembly hardware available separately, see pages M-8 and M-9.

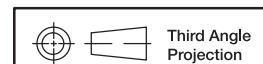

Dimensions are shown: Inches (mm)  
Specifications and dimensions subject to change

Thumbwheel



M



# 3 Series Thumbwheel Switches

## MOUNTING STYLE

### Type 1 Rear Mount

MOUNTING STYLE	DIM. 'A'	DIM. 'B'
10	$(.350 \times N) + .340$ $(8.89 \times N) + (8.64)$	$(.350 \times N) + .560$ $(8.89 \times N) + (14.22)$

N = Number of sections.  
Recommended panel thickness:  
0.46-.125  
(1.16-3.18)

### PANEL MOUNTING

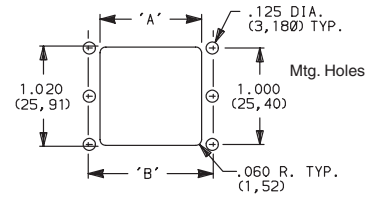

### 10 SWITCH ASSEMBLY W/ ENDPLATES--.350 (8,89) SECTION PITCH

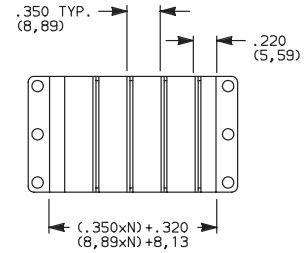
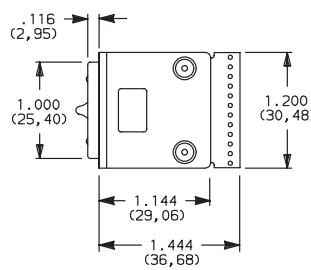
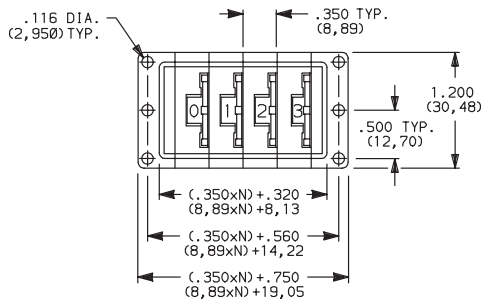

N = Number of sections.

### 19 SWITCH SECTION ONLY--UNASSEMBLED WITHOUT ENDPLATES OR SPACERS (Must be ordered with number of sections option "0", see Page M-4.)

### Type 2 Rear Mount

### 20 SWITCH ASSEMBLY W/ ENDPLATES--.350 (8,89) SECTION PITCH

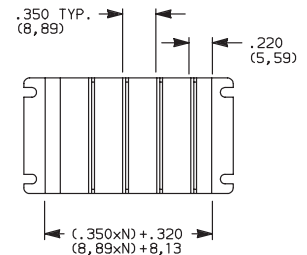
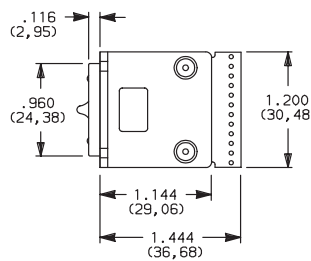
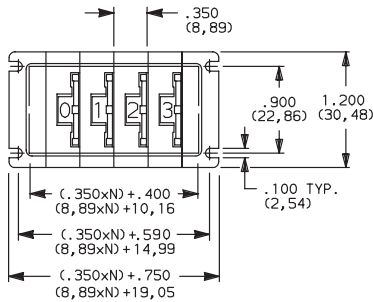

N = Number of sections.

### 29 SWITCH SECTION ONLY--UNASSEMBLED WITHOUT ENDPLATES OR SPACERS (Must be ordered with number of sections option "0", see Page M-4.)

Thumbwheel



M

**NOTE:** Endplates, blank sections, spacers and assembly hardware available separately, see pages M-8 and M-9.

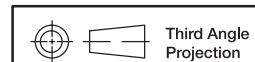

Dimensions are shown: Inches (mm)  
Specifications and dimensions subject to change

# 3 Series Thumbwheel Switches

## TERMINATIONS

**0** TYPE 0

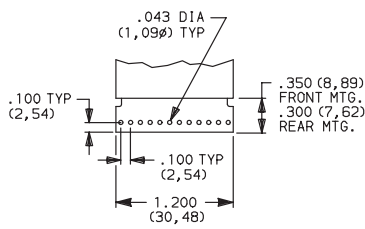

**1** TYPE 1, EXTENDED TYPE 0

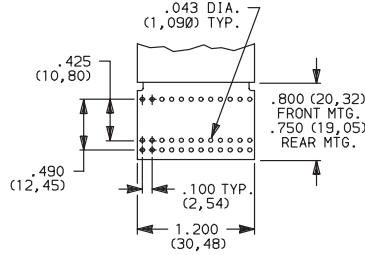

Signal traces cut except for common(s).

**N** SOLDER PINS WITH .100" SPACING

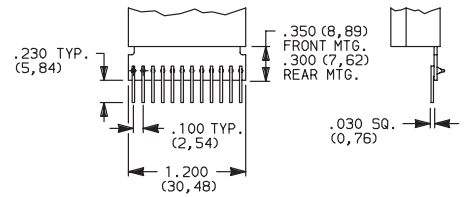

**P** SOLDER PINS WITH .156" SPACING

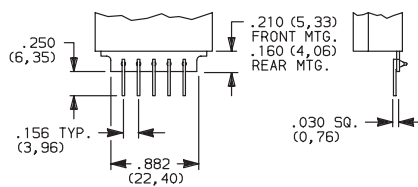

PC Board 1/32" (0,79) thick.

**6** TYPE 6, NO PINS

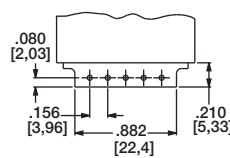

**9** ANY COMBINATION OF TERMINATION CONFIGURATIONS OR SPECIAL TERMINATIONS.

Specify on configuration form, page M-10 and consult Customer Service Center.

**NOTE:** All terminal holes shown may not be present for all function codes, consult Customer Service Center. Terminal connector available for termination options 0 & 1, see page M-9.

**NOTE:** Termination option N (RoHS compliant) replaced termination option 3 (Non-RoHS compliant). Termination option P (RoHS compliant) replaced termination option B (Non-RoHS compliant).

## Terminal Location Numbers

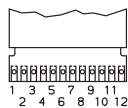

FIG. 1



FIG. 2

**NOTE:** See function codes, pages M-4 and M-5, for signal locations.

## COLOR/MARKING/STOPS

**0** MATTE BLACK HOUSING (Gloss black wheel with white characters; no stops.)

**NOTE:** Stop pins are available separately, see page M-8.

## SEAL

**0** UNSEALED SWITCHING CONTACTS.

**1** SEALED SWITCHING CONTACTS. (Sealing is by means of an o-ring rotary seal and a cured-in-place elastomer gasket. Switching contact area is protected from moisture, oil, and airborne contaminants.)

**2** DUST LENS. (Protects the character face of the wheel from abrasion and dirt.)

**3** SEALED SWITCHING CONTACTS AND DUST LENS



Dust Lens

Thumbwheel



M



Third Angle  
Projection

Dimensions are shown: Inches (mm)  
Specifications and dimensions subject to change

# 3 Series Thumbwheel Switches

## AVAILABLE HARDWARE

Blank sections, Type 0,  
.315 THK.



**PART NO.**  
**413602000** W/RIB-BLACK  
**400502000** W/RIB & W/OUT SPRINGS-BLACK

Blank sections, Front mount, Type 0,  
.315 THK.



**PART NO.**  
**413502000** PLAIN-BLACK  
**400702000** PLAIN & W/OUT SPRINGS-BLACK

Blank sections, Rear mount, Type 1,  
.350 THK.



4006 4008

**PART NO.**  
**400602000** W/RIB-BLACK  
**400802000** PLAIN-BLACK

Blank sections, Rear mount, Type 2,  
.350 THK.



4734 4733

**PART NO.**  
**473402000** W/RIB-BLACK  
**473302000** PLAIN-BLACK

End plates, Front mount, Type 0



**PART NO.**  
**413402000** BLACK

Two required for complete assembly.

End plates, Rear mount, Type 1



**PART NO.**  
**400402003** BLACK

Two required for complete assembly.

End plates, Rear mount, Type 2

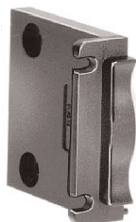

**PART NO.**  
**473202003** BLACK

Two required for complete assembly.

Spacers, Front mount, Type 0 & 3, .078 THK.  
(Makes section pitch 10mm)



**PART NO.**  
**410802000** BLACK

Stop pins



**PART NO.**  
**402900000**

Thumbwheel



M



Dimensions are shown: Inches (mm)  
 Specifications and dimensions subject to change

# 3 Series Thumbwheel Switches

## AVAILABLE HARDWARE

### Terminal connector



605A00000



605A02000

### PART NO.

605A00000 PC

605A02000 SOLDER LUG

Fits 0 & 1 terminations only.

Screws for field assembly of thumbwheel switches  
(2 screws needed per assembly + 403500000 nuts)

SCREW PART NUMBER (0-80 UNF THD. SIZE)	NUMBER OF SECTIONS IN ASSEMBLY	
	FRONT MOUNTING	REAR MOUNTING
	MTG. STYLE - 00	MTG. STYLE - 10
412700000	1-2	1-2
412701000	3-4	3
412702000	5-7	4-6

### Nut



Two nuts required per assembly and screws.

### PART NO.

403500000

### Nut driver (For 403500000 nut)



### PART NO.

406100652

Thumbwheel



M

# 3 Series Thumbwheel Switches

## Configuration Form

GRAY SHADED AREAS TO BE FILLED IN BY CUSTOMER SERVICE.

CATALOG PART NO.

**3**

C&K PART NUMBER

C&K PART NUMBER

COMPANY NAME \_\_\_\_\_











CUSTOMER  
PRINT  
REVISION:

ADDRESS \_\_\_\_\_ TEL.# \_\_\_\_\_

CUSTOMER CONTACT \_\_\_\_\_ DATE \_\_\_\_\_

DETAILS:

ORIGINATED BY \_\_\_\_\_ SALES REP. \_\_\_\_\_

THUMBWHEEL SECTIONS	NO. OF SEC.	FUNCTION CODE – TERMINATIONS – COLOR/MARKING/STOPS/SEAL – ILLUMINATION <small>ENTER OPTION CODES IN APPROPRIATE BOXES. FUNCTION CODES INCLUDE BLANK SECTIONS (SEE PAGES M-9 &amp; M-10).</small>	DESCRIBE IN APPROPRIATE ROW
	<b>1</b>	3 - <input type="text"/> <input type="text"/> - - <input type="text"/> <input type="text"/> <input type="text"/> <input type="text"/>	
	<b>2</b>	3 - <input type="text"/> <input type="text"/> - - <input type="text"/> <input type="text"/> <input type="text"/> <input type="text"/>	
	<b>3</b>	3 - <input type="text"/> <input type="text"/> - - <input type="text"/> <input type="text"/> <input type="text"/> <input type="text"/>	
	<b>4</b>	3 - <input type="text"/> <input type="text"/> - - <input type="text"/> <input type="text"/> <input type="text"/> <input type="text"/>	
	<b>5</b>	3 - <input type="text"/> <input type="text"/> - - <input type="text"/> <input type="text"/> <input type="text"/> <input type="text"/>	
	<b>6</b>	3 - <input type="text"/> <input type="text"/> - - <input type="text"/> <input type="text"/> <input type="text"/> <input type="text"/>	
	<b>7</b>	3 - <input type="text"/> <input type="text"/> - - <input type="text"/> <input type="text"/> <input type="text"/> <input type="text"/>	
	<b>8</b>	3 - <input type="text"/> <input type="text"/> - - <input type="text"/> <input type="text"/> <input type="text"/> <input type="text"/>	
	<b>9</b>	3 - <input type="text"/> <input type="text"/> - - <input type="text"/> <input type="text"/> <input type="text"/> <input type="text"/>	
	<b>10</b>	3 - <input type="text"/> <input type="text"/> - - <input type="text"/> <input type="text"/> <input type="text"/> <input type="text"/>	
	<b>11</b>	3 - <input type="text"/> <input type="text"/> - - <input type="text"/> <input type="text"/> <input type="text"/> <input type="text"/>	

Thumbwheel



M

QUALITY CONTROL INSTRUCTIONS

PRODUCTION APPROVAL

DATE

Q.C. APPROVAL

DATE

REV.

INITIALS

DATE

FOR SWITCHES WITH MORE THAN 11 SECTIONS, CONTINUE ON ADDITIONAL SHEETS.

SPECIAL INSTRUCTIONS OR SPECIFICATIONS:

SHEET \_\_\_\_ OF \_\_\_\_



Dimensions are shown: Inches (mm)  
Specifications and dimensions subject to change