

DF Series Power Rocker Switches



Features/Benefits

- Power switching up to 16 AMPS
- Sub-panel and Front-panel mounting
- PC and quick connect terminals
- Multi-position and multi-pole function
- RoHS compliant

Typical Applications

- Computers
- Power supplies
- Appliances
- Fitness equipment
- Off-road vehicles



Specifications

CONTACT RATING: 16 AMPS @ 125, 250 V AC; 1/4 HP @ 125 V AC; 1/2 HP @ 250 V AC; 6 AMPS @ 48 V DC, 2 AMPS @ 60 V DC, 11 AMPS @ 30 V DC

ELECTRICAL LIFE: 10,000 make-and-break cycles at full load.

INSULATION RESISTANCE: $10^9 \Omega$ min.

DIELECTRIC STRENGTH: 1,000 Vrms min. @ sea level.

OPERATING TEMPERATURE: -20°C to +85°C

Materials

HOUSING & ACTUATOR: 6/6 nylon (UL 94V-2), black, finish: matte.

CONTACTS: Fine silver, silver plated.

TERMINALS: Copper, silver plated.

CONTACT SPRING: Music wire or stainless steel.

NOTE: Specifications and materials listed above are for standard switches. For information on specific and custom switches, consult Customer Service Center.

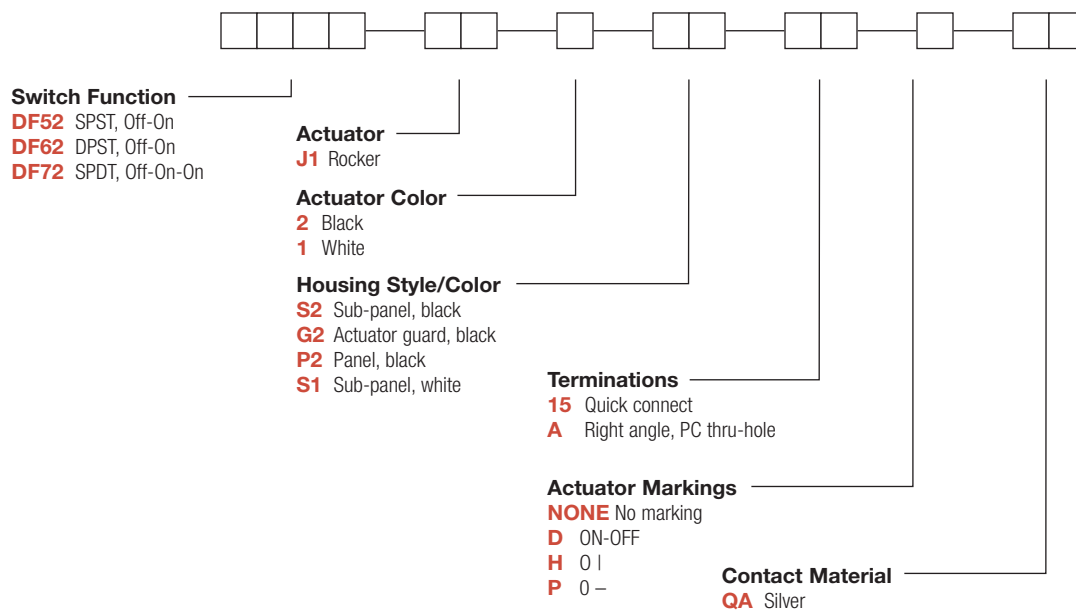

Build-A-Switch

To order, simply select desired option from each category and place in the appropriate box. Available options are shown and described on pages G-74 thru G-76. For additional options not shown in catalog, consult Customer Service Center.



DF Series Power Rocker Switches





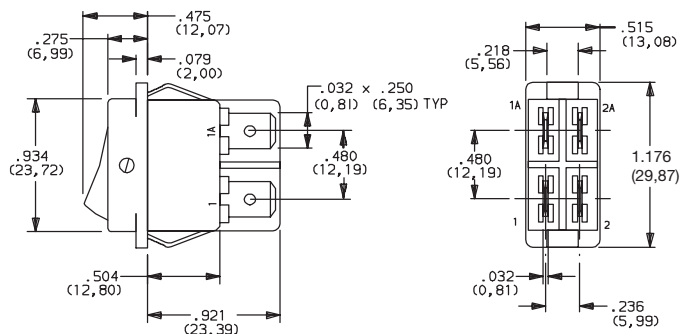

SWITCH FUNCTION

NO. POLES	MODEL NO.	SWITCH FUNCTION		CONNECTED TERMINALS		SCHEMATIC
		POS. 1	POS. 2	POS. 1	POS. 2	
SP	DF52	OFF	ON	OPEN	1-1A	SPST 
DP	DF62	OFF	ON	OPEN	1-1A, 2-2A	DPST 

Part Number shown DF62J12S215QA

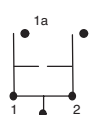
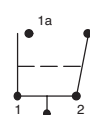
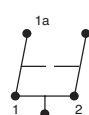

Actuator shown in Pos. 1

NO. POLES	MODEL NO.	POS. 1	POS. 2	POS. 3	POS. 1	POS. 2	POS. 3	SCHEMATIC
								
SP	DF72	OFF	ON	ON	OPEN	1 / 2-A	1 / 2-1A 1 / 2-2A	  

All models  US

ACTUATOR

J1 ROCKER

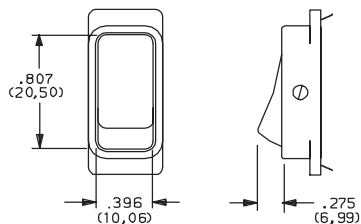

OPTION CODE	ACTUATOR COLOR
2	BLACK
1	WHITE

NOTE: Actuator finish: matte. Other colors available, consult Customer Service Center.

Rocker



G

C&K



Dimensions are shown: Inches (mm)
Specifications and dimensions subject to change

DF Series Power Rocker Switches

HOUSING STYLE/COLOR



S SUB-PANEL

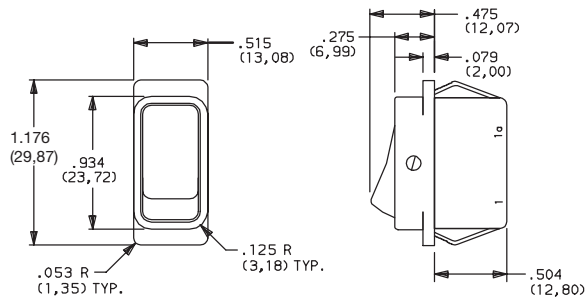

NOTE: DF52 & DF62 models only.

G2 ACTUATOR GUARD

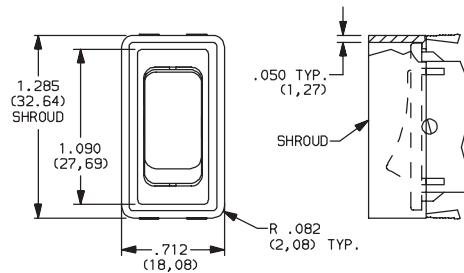

NOTE: Not available with 'A' termination. Available in black only.

P PANEL

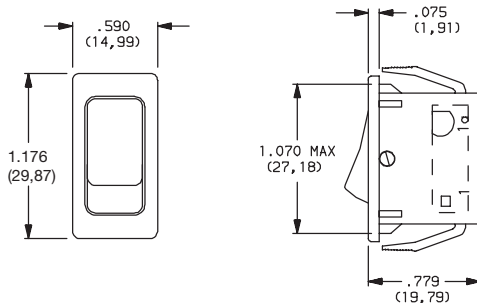

NOTE: Not available with 'A' termination. Available in black only.

OPTION CODE	HOUSING COLOR
2	(STD.) BLACK
1	WHITE

NOTE: Housing finish: matte. Other colors available, consult Customer Service Center.

PANEL MOUNTING

PANEL THICKNESS	DIM 'A'
.029-.048 (0,74) (1,22)	1.021 (25,93)
.048-.078 (1,22) (1,98)	1.029 (26,14)
.078-.117 (1,98) (2,97)	1.045 (26,54)
.075-.140 (1,91) (3,56)	1.075 (27,31)

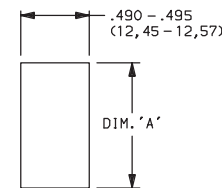

DF52 & DF62 Models with 'S' housing style

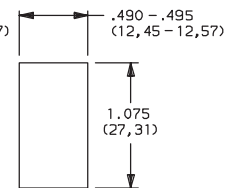

DF52, DF62 & DF72 Models with 'P2' & 'G2' housing style

TERMINATIONS



15 QUICK CONNECT

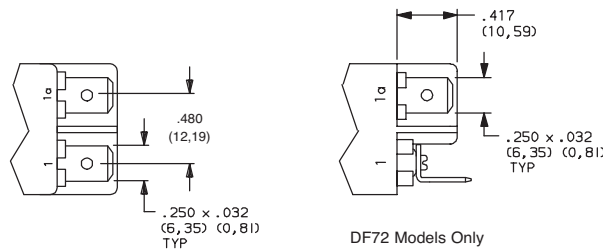

A RIGHT ANGLE, PC THRU-HOLE

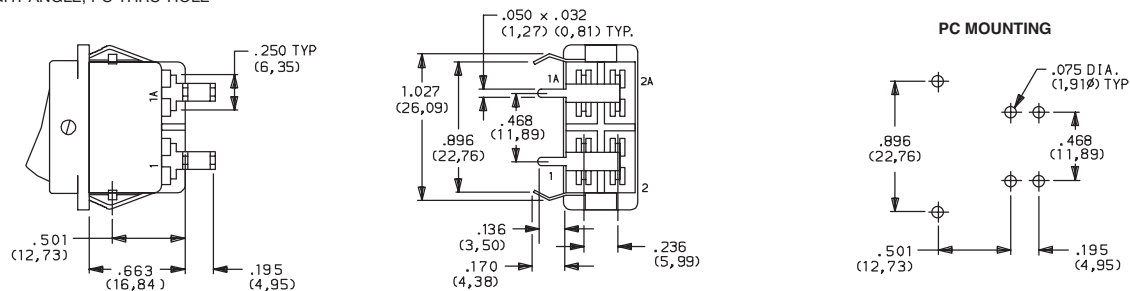

Actuator shown in Pos. 1

NOTE: DF52 and DF62 Models Only

PC MOUNTING

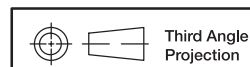
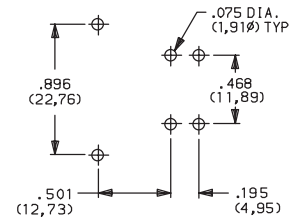

Third Angle Projection

Dimensions are shown: Inches (mm)
Specifications and dimensions subject to change



DF Series Power Rocker Switches

ACTUATOR MARKINGS

NONE NO MARKING

D ON-OFF

H O |

P O -

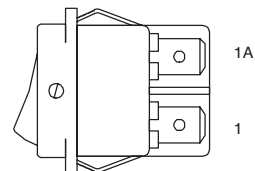

NOTE: Orientation of actuator markings and terminals.

'D, H, & P' marking options: marking color white, standard for all actuator colors except white. Marking color black, standard for white actuators. Consult Customer Service Center for other available marking colors.

CONTACT MATERIAL

OPTION CODE	CONTACT AND TERMINAL MATERIAL	RATINGS	
		POWER	
QA	SILVER 1,2		16 AMPS @ 125, 250 V AC; 1/4 HP @ 125 V AC; 1/2 HP @ 250 V AC; 6 AMPS @ 48 V DC (UL), 2 AMPS @ 60 V DC, 11 AMPS @ 30 V DC
			16 AMPS @ 125, 250 V AC; 1/4 HP @ 125 V AC; 1/2 HP @ 250 V AC (UL)

* Note: See Technical Data section of this catalog for RoHS compliant and compatible definitions and specifications.

1 CONTACTS: Fine silver, silver plated.

All models 

2 TERMINALS: Copper, silver plated.

AVAILABLE HARDWARE

Actuator Guard

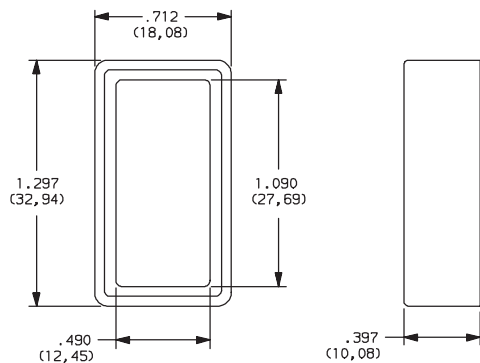

PART NO.

285B02000

Material: Nylon 6/6
Finish: Matte

Rocker



G

C&K



Third Angle Projection

Dimensions are shown: Inches (mm)
Specifications and dimensions subject to change