



3.2 x 2.5 mm Precision TCXO Model D32G

CONNOR WINFIELD



2111 Comprehensive Drive

Aurora, Illinois 60505

Phone: 630-851-4722

Fax: 630-851-5040

www.conwin.com

US Headquarters:

630-851-4722

European Headquarters:

+353-61-472221

Description:

The Connor-Winfield D32G is a 3.2 x 2.5 mm, 3.3 V Clipped Sinewave, Surface Mount, Temperature Compensated Crystal Oscillator (TCXO) designed for applications requiring tight frequency stability in a very small package. The RoHS compliant surface mount package is designed for high-density mounting and is optimum for mass production.

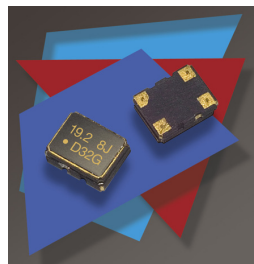

Features:

- 3.3 Vdc Operation
- Clipped Sinewave Output
- Frequency Stability: ± 0.50 ppm
- Temperature Range: -30 to 85°C
- Low Jitter: < 1 ps RMS
- 3.2 x 2.5 mm SMT Package
- Tape and Reel Packaging
- RoHS Compliant / Lead Free

Absolute Maximum Ratings

Parameter	Minimum	Nominal	Maximum	Units	Notes
Storage Temperature	-55	-	85	$^{\circ}\text{C}$	
Supply Voltage (Vcc)	-0.5	-	6.0	Vdc	

Operating Specifications

Parameter	Minimum	Nominal	Maximum	Units	Notes
Center Frequency: (Fo)	16.368, 19.2, 26.0 or 32.736			MHz	
Frequency Calibration @ 25°C	-1.0	-	1.0	ppm	1
Frequency Stability					
Vs. Temperature:	-0.50	-	0.50	ppm	2
VS. Supply Voltage:	-0.025	-	0.025	ppm	$\pm 5\%$
VS. Load:	-0.025	-	0.025	ppm	$\pm 5\%$
Static Temperature Hysteresis:	-	-	0.40	ppm	Absolute, 3
Aging per Year	-1.0	-	1.0	ppm	
Freq. Shift Due to Solder Reflow:	-1.0	-	1.0	ppm	4
Operating Temperature Range:	-30	-	85	$^{\circ}\text{C}$	
Supply Voltage (Vcc) $\pm 5\%$	3.135	3.3	3.465	Vdc	
Supply Current (Icc)	-	-	2.0	mA	
Period Jitter	-	3	5	ps rms	
Integrated Phase Jitter	-	0.5	1.0	ps rms	5
SSB Phase Noise at 10Hz offset	-	-80	-	dBc/Hz	
SSB Phase Noise at 100Hz offset	-	-110	-	dBc/Hz	
SSB Phase Noise at 1KHz offset	-	-130	-	dBc/Hz	
SSB Phase Noise at 10KHz offset	-	-145	-	dBc/Hz	
SSB Phase Noise at 100KHz offset	-	-145	-	dBc/Hz	
Start-up Time-	-	-	5	ms	

Clipped Sinewave Output Characteristics

Parameter	Minimum	Nominal	Maximum	Units	Notes
Load (CL) -	10 pF // 10 KOhm				6
Output Voltage (High)	1.0	-	-	V pk to pk	7

Package Characteristics

Package Hermetically sealed ceramic package and metal cover

Ordering Information

D32G-016.368M*, D32G-019.2M*, D32G-026.0M* or D32G-032.736M*

* For the tape and reel option, add -T to the end of the part number. Example: D32G-016.368M-T

Notes:

1. Initial calibration @ 25°C . Specifications at time of shipment after 48 hours of operation.
2. Frequency stability vs. change in temperature. $[\pm(F_{\text{max}} - F_{\text{min}})/2.F_0]$.
3. Frequency change after reciprocal temperature ramped over the operating range. Frequency measured before and after at 25°C .
4. Within two hours after reflow
5. BW = 12 KHz to 20 MHz.
6. Output is DC coupled. Load capacitor, load resistor, coupling capacitor and by pass capacitors are required components to insure proper operation of this TCXO.
7. For best performance it is recommended that the circuit connected to this output should have an equivalent input capacitance of 10pF.

Bulletin **TX240**Page **1 of 2**Revision **06**Date **09 Oct 2012**



Environmental Characteristics

Vibration:	Vibration per Mil Std 883E Method 2007.3 Test Condition A
Shock:	Mechanical Shock per Mil Std 883E Method 2002.4 Test Condition B.
Soldering Process:	RoHS compliant lead free. See soldering profile on page 2.

Pad Connections

1:	N/C
2:	Ground
3:	Output
4:	Supply Voltage (Vcc)

Package Layout

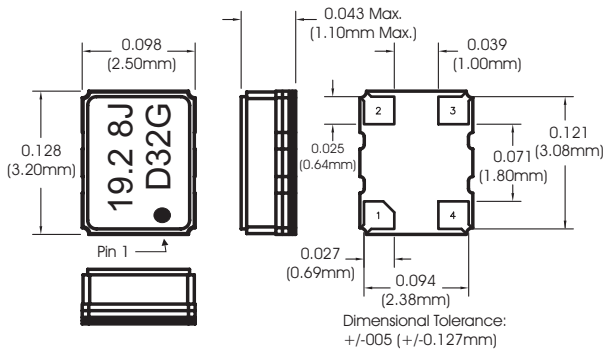

Suggested Pad Layout

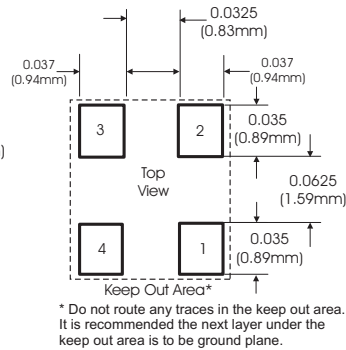

Output Waveform

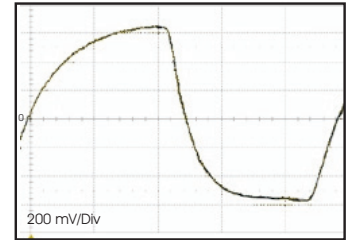

Typical Phase Noise Plot

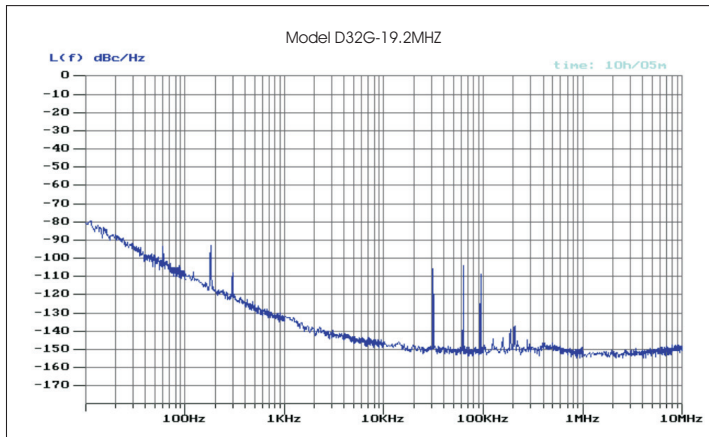

Test Circuit

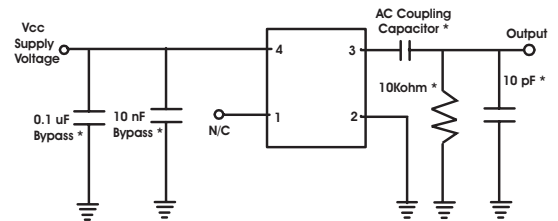

* Required components to insure proper operation.

Tape and Reel Information

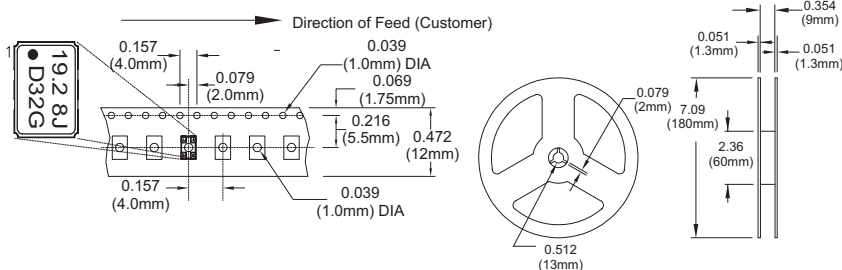

Revision History

Rev 02;	Data sheet released. 02/20/09
Rev 03;	Updated pad size on package drawing and updated suggested pad layout. 12/17/09.
Rev 04;	Changed ordering information. Updated to new data sheet format. 11/03/11.
Rev 05;	Changed note 6, added load capacitor and resistor information 12/19/11.
Rev 06;	Added new frequency. 10/09/12

Solder Profile

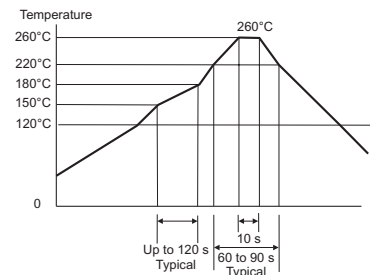

Meets IPC/JEDEC J-STD-020C

Bulletin	TX240
Page	2 of 2
Revision	06
Date	09 Oct 2012