

SERIES: PEM2-S | **DESCRIPTION:** DC-DC CONVERTER

FEATURES

- 2 W isolated output
- smaller package
- single/dual unregulated output
- 3,000 Vdc isolation
- continuous short circuit protection
- extended temperature range (-40~105°C)
- antistatic protection up to 8kV
- high efficiency at light load
- efficiency up to 89%



MODEL	input voltage		output voltage (Vdc)	output current		output power max (W)	ripple and noise ¹ typ (mVp-p)	efficiency typ (%)
	typ (Vdc)	range (Vdc)		min (mA)	max (mA)			
PEM2-S5-S5-S	5	4.5~5.5	5	40	400	2	60	89
PEM2-S5-S12-S	5	4.5~5.5	12	16.6	166.6	2	60	84
PEM2-S5-S15-S	5	4.5~5.5	15	13.3	133.3	2	75	84
PEM2-S5-S24-S	5	4.5~5.5	24	8.3	83.3	2	75	84
PEM2-S5-D5-S	5	4.5~5.5	±5	±20	±200	2	60	84
PEM2-S5-D12-S	5	4.5~5.5	±12	±8.3	±83.3	2	60	84
PEM2-S5-D15-S	5	4.5~5.5	±15	±6.7	±66.6	2	75	84
PEM2-S5-D24-S	5	4.5~5.5	±24	±4.2	±41.6	2	75	84
PEM2-S12-S5-S	12	10.8~13.2	5	40	400	2	60	84
PEM2-S12-S12-S	12	10.8~13.2	12	16.6	166.6	2	60	84
PEM2-S12-S15-S	12	10.8~13.2	15	13.3	133.3	2	75	84
PEM2-S12-D5-S	12	10.8~13.2	±5	±20	±200	2	60	84
PEM2-S12-D12-S	12	10.8~13.2	±12	±8.3	±83.3	2	60	85
PEM2-S12-D15-S	12	10.8~13.2	±15	±6.7	±66.6	2	75	84
PEM2-S15-D15-S	15	13.5~16.5	±15	±6.7	±66.6	2	75	85
PEM2-S24-S5-S	24	21.6~26.4	5	40	400	2	60	84
PEM2-S24-S12-S	24	21.6~26.4	12	16.6	166.6	2	60	84
PEM2-S24-S15-S	24	21.6~26.4	15	13.3	133.3	2	75	84
PEM2-S24-S24-S	24	21.6~26.4	24	8.3	83.3	2	75	85
PEM2-S24-D5-S	24	21.6~26.4	±5	±20	±200	2	60	84
PEM2-S24-D12-S	24	21.6~26.4	±12	±8.3	±83.3	2	60	84
PEM2-S24-D15-S	24	21.6~26.4	±15	±6.7	±66.6	2	75	84

Notes: 1. ripple and noise are measured at 20 MHz BW by "parallel cable" method

PART NUMBER KEY

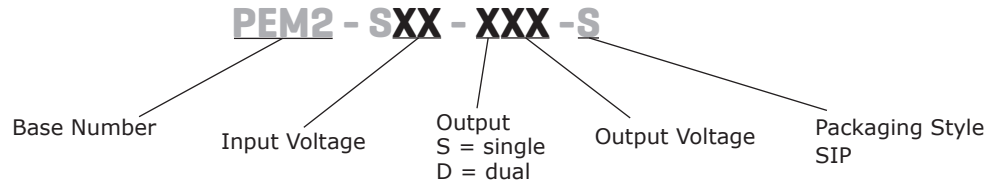

INPUT

parameter	conditions/description	min	typ	max	units
operating input voltage	5 V input models	4.5	5	5.5	Vdc
	12 V input models	10.8	12	13.2	Vdc
	15 V input models	13.5	15	16.5	Vdc
	24 V input models	21.6	24	26.4	Vdc
surge voltage	for maximum of 1 second				
	5 V input models	-0.7		9	Vdc
	12 V input models	-0.7		18	Vdc
	15 V input models	-0.7		21	Vdc
	24 V input models	-0.7		30	Vdc
filter	capacitance filter				

OUTPUT

parameter	conditions/description	min	typ	max	units
line regulation	for Vin change of 1%			±1.2	%
load regulation	measured from 10% load to full load			15	%
voltage accuracy	see tolerance envelope curve				
voltage balance	dual output, balanced loads		±0.5	±1	%
switching frequency	100% load, nominal input voltage		100	300	kHz
temperature coefficient	100% load			±0.03	%/°C

PROTECTIONS

parameter	conditions/description	min	typ	max	units
short circuit protection	continuous, automatic recovery				

SAFETY AND COMPLIANCE

parameter	conditions/description	min	typ	max	units
isolation voltage	for 1 minute at 1 mA max.	3,000			Vdc
isolation resistance	at 500 Vdc	1,000			MΩ
conducted emissions	CISPR22/EN55022, class B (external circuit required)				
ESD	IEC/EN61000-4-2, class B, contact ± 8kV for single outputs IEC/EN61000-4-2, class B, contact ± 6kV for dual outputs				
MTBF	as per MIL-HDBK-217F @ 25°C	3,500,000			hours
RoHS compliant	yes				

ENVIRONMENTAL

parameter	conditions/description	min	typ	max	units
operating temperature	see derating curve	-40		105	°C
storage temperature		-55		125	°C
storage humidity	non-condensing			95	%
temperature rise	at full load		25		°C

SOLDERABILITY

parameter	conditions/description	min	typ	max	units
hand soldering	1.5 mm from case for 10 seconds			300	°C
wave soldering	see wave soldering profile			260	°C

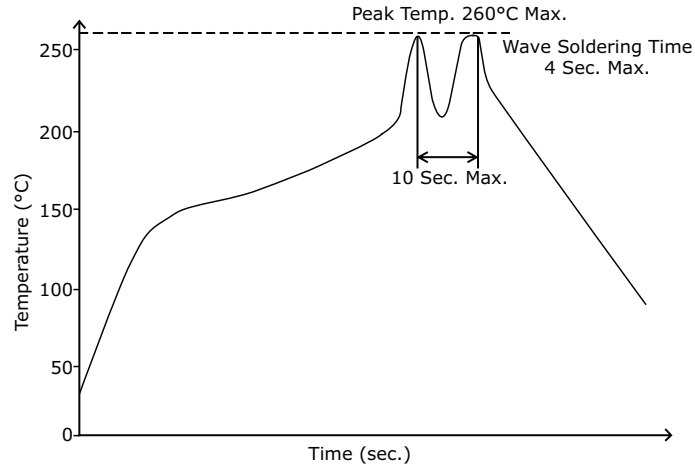

MECHANICAL

parameter	conditions/description	min	typ	max	units
dimensions	19.60 x 7.00 x 10.00 (0.772 x 0.276 x 0.394 inch)				mm
case material	plastic (UL94-V0)				
weight			2.4		g

MECHANICAL DRAWING

units: mm[inch]
tolerance: ±0.50[±0.020]
pin section tolerance: ±0.10[±0.004]

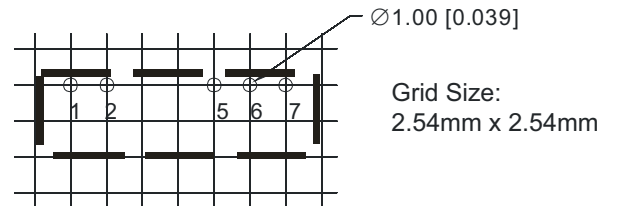
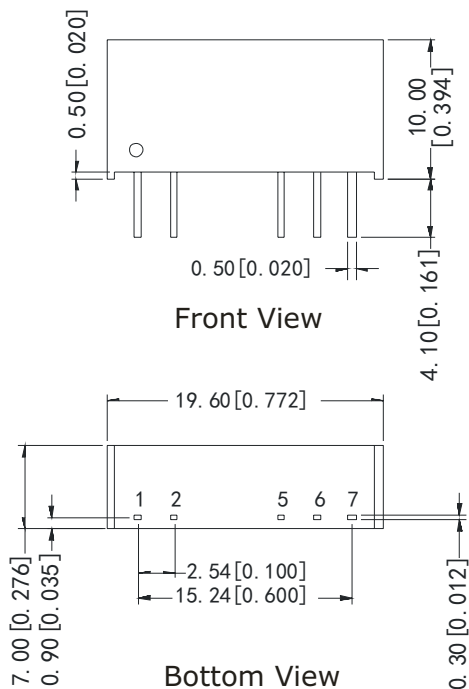

PCB Layout
Top View

PIN CONNECTIONS		
PIN	Single Output	Dual Output
1	V _{in}	V _{in}
2	GND	GND
5	0V	-V _o
6	No Pin	0V
7	+V _o	+V _o

DERATING CURVES

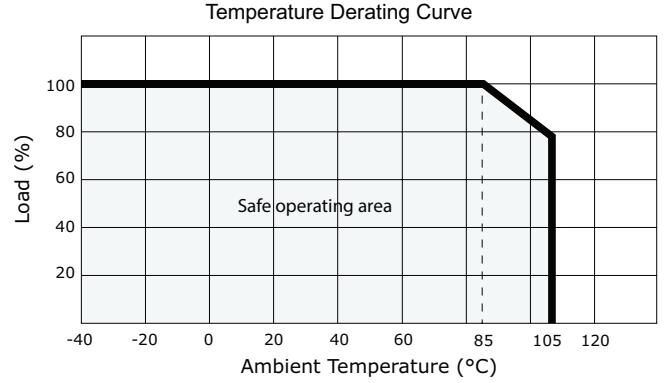
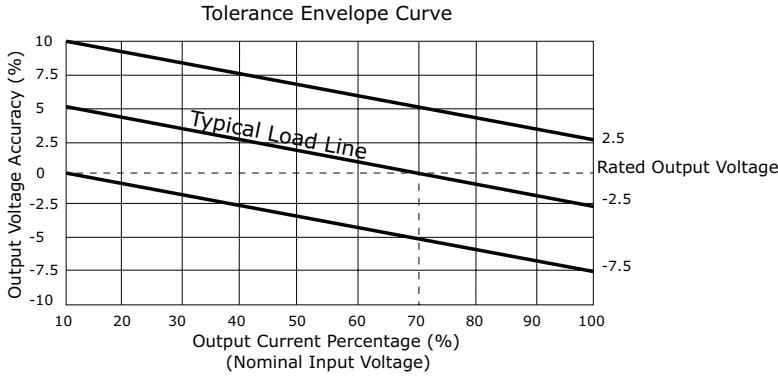

EMC RECOMMENDED CIRCUIT

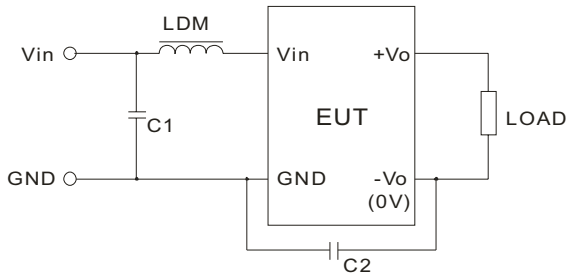

Recommended external circuit components			
V_{in} (Vdc)	C1	LDM	C2
5	475K/50V	6.8 μ H	NC
12	475K/50V	6.8 μ H	NC
15	475K/50V	6.8 μ H	470pF/3kV
24	475K/50V	6.8 μ H	470pF/3kV

TEST CONFIGURATION

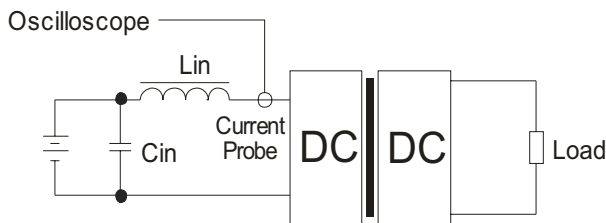

External components	
L_{in}	4.7 μ H
C_{in}	220 μ F, ESR < 1.0 Ω at 100 KHz

Note: Input reflected-ripple current is measured with an inductor L_{in} and Capacitor C_{in} to simulate source impedance.

APPLICATION NOTES

1. Requirement on output load

To ensure this module can operate efficiently and reliably, the minimum output load may not be less than 10% of the full load during operation. If the actual output power is low, connect a resistor at the output end in parallel to increase the load.

2. Overload Protection

Under normal operating conditions, the output circuit of this product has no protection against overload. The simplest method to add this is to add a circuit breaker to the circuit.

3. Recommended circuit

If you want to further decrease the input/output ripple, you can increase the capacitance accordingly or choose capacitors with low ESR (see Figure 1). However, the capacitance of the output filter capacitor must be appropriate. If the capacitance is too high, a startup problem might arise. For every channel of the output, to ensure safe and reliable operation, the maximum capacitance must be less than the maximum capacitive load (see Table 1).

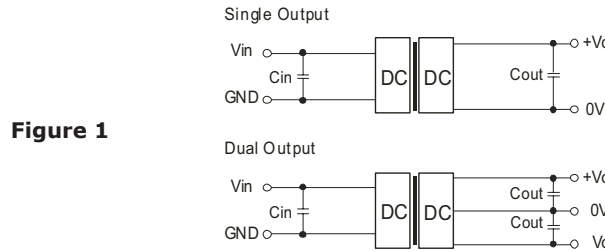

Figure 1

Vin (Vdc)	Cin (μF)	Single Vo (Vdc)	Cout (μF)	Dual Vo (Vdc)	Cout (μF)
5	4.7	5	10	±5	4.7
12	2.2	12	2.2	±12	1
15	2.2	15	1	±15	0.47
24	1	24	1	±24	0.47

Table 1

It's not recommended to connect any external capacitors in applications with less than 0.5 watt output.

4. Output Voltage Regulation and Over-voltage Protection Circuit

The device for output voltage regulation, over-voltage and over-current protection is a linear regulator and a capacitor filtering network with overheat protection which can be connected to the input or output end in series (see Figure 2). The recommended capacitance of its filter capacitor (see Table 1), and the linear regulator is based on the actual voltage and current required.

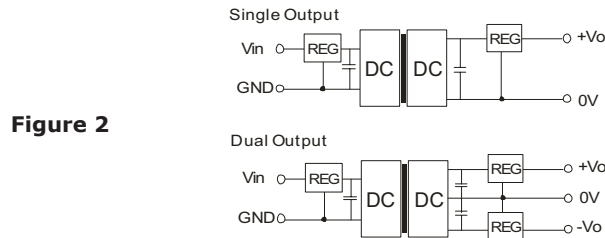

Figure 2

Note: 1. Operation under minimum load will not damage the converter; however, they may not meet all specifications listed.
 2. Max. capacitive load tested at input voltage range and full load.
 3. All specifications measured at: Ta=25°C, humidity<75%, nominal input voltage and rated output load, unless otherwise specified.

REVISION HISTORY

rev.	description	date
1.0	initial release	03/21/2013

The revision history provided is for informational purposes only and is believed to be accurate.



CUI INC[®]

Headquarters
20050 SW 112th Ave.
Tualatin, OR 97062
800.275.4899

Fax 503.612.2383
cui.com
techsupport@cui.com

CUI offers a two (2) year limited warranty. Complete warranty information is listed on our website.

CUI reserves the right to make changes to the product at any time without notice. Information provided by CUI is believed to be accurate and reliable. However, no responsibility is assumed by CUI for its use, nor for any infringements of patents or other rights of third parties which may result from its use.

CUI products are not authorized or warranted for use as critical components in equipment that requires an extremely high level of reliability. A critical component is any component of a life support device or system whose failure to perform can be reasonably expected to cause the failure of the life support device or system, or to affect its safety or effectiveness.