

**SERIES:** PPR-1U | **DESCRIPTION:** RACK ACCESSORY

**FEATURES**

- up to 12,000 W continuous power
- operation from a wide range AC input (90~260 Vac) incoming (Line-Neutral) AC source on a per module basis
- 19" four slot power shelf
- 48 or 54 Vdc output voltage (from PSE-3000 modules)
- single or dual output configurations
- integral forced cooling, from internal fans housed within the power modules
- front to back & back to front airflow versions
- 3.3 Vdc (2 A) standby voltage
- redundant (N+1) operation
- blind mate connections for hot-swap
- adjustable mounting brackets
- racks can share with on additional rack in a master slave arrangement
- EMI filtering of the AC input directly in line with the IEC 320 inlet connectors to meet Class A performance
- user accessible dip-switch for setting master or slave shelf

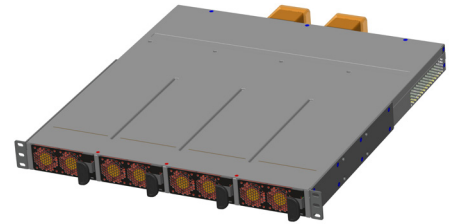

MODEL <sup>1</sup>	output voltage <sup>1</sup> (Vdc)	airflow direction	output configuration <sup>2</sup>	output power (max)	
				110 Vin (W)	220 Vin (W)
PPR-1U	48 or 54	front to back	single output, configuration A	6,000	12,000
PPR-1U-A	48 or 54	front to back	dual output	6,000	12,000
PPR-1U-B	48 or 54	back to front	single output, configuration A	5,400	12,000
PPR-1U-C	48 or 54	back to front	dual output	5,400	12,000
PPR-1U-D	48 or 54	front to back	single output, configuration B	6,000	12,000
PPR-1U-E	48 or 54	back to front	single output, configuration B	5,400	12,000

Notes: 1. Rack assembly requires (4) PSE-3000-48 or PSE-3000-54 units (sold separately). Refer to the PSE-3000 datasheet for specification details.  
 2. See page 3 for configuration details.  
 3. All specifications measured at: Ta=25°C and 220 Vac input voltage unless otherwise specified.

**PART NUMBER KEY**

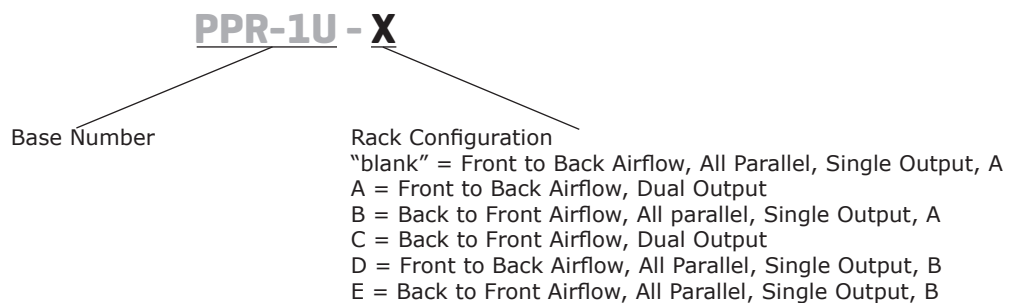

## POWER SHELF

Power Shelf Model Number	Power Module Model Number	Airflow Direction	Shelf Power		Standby Output	IEC Inlet Type
			110 Vin	220 Vin		
PPR-1U	PSE-3000-48-F or PSE-3000-54-F	Front to Back	6,000 W	12,000 W	All Parallel, single output, configuration A	C22
PPR-1U-A	PSE-3000-48-F or PSE-3000-54-F	Front to Back	6,000 W	12,000 W	dual output	C22
PPR-1U-B	PSE-3000-48-B or PSE-3000-54-B	Back to Front	5,400 W	12,000 W	All Parallel, single output configuration A	C20
PPR-1U-C	PSE-3000-48-B or PSE-3000-54-B	Back to Front	5,400 W	12,000 W	dual output	C20
PPR-1U-D	PSE-3000-48-F or PSE-3000-54-F	Front to Back	6,000 W	12,000 W	All Parallel, single output configuration B	C22
PPR-1U-E	PSE-3000-48-B or PSE-3000-54-B	Back to Front	5,400 W	12,000 W	All Parallel, single output configuration B	C20

### PPR-1U, PPR-1U-A, PPR-1U-D - FRONT TO BACK AIRFLOW

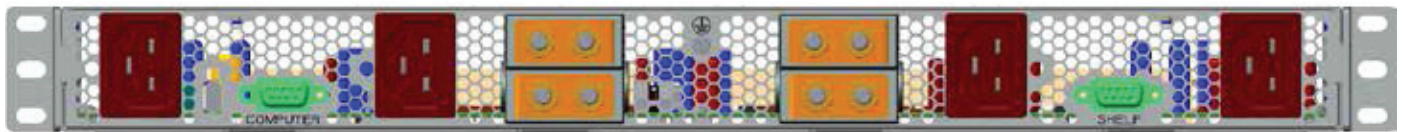

### PPR-1U-B, PPR-1U-C, PPR-1U-E - BACK TO FRONT AIRFLOW

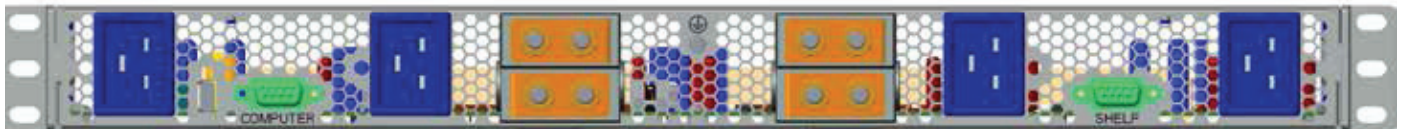

## POWER SHELF (CONTINUED)

### PPR-1U & PPR-1U-B Output Terminal Block Configuration (Single Output, Configuration A)

All 4 power modules wired in parallel inside the power shelf, 6 kW available from each output terminal block set

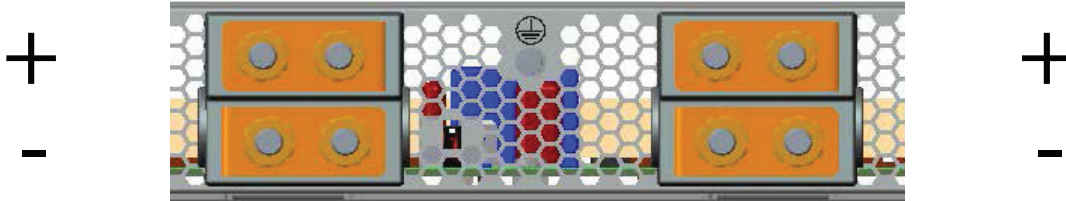

### PPR-1U-A & PPR-1U-C Output Terminal Block Configuration (Dual Output)

Each terminal block wired to 2 power modules, 6 kW available from each output

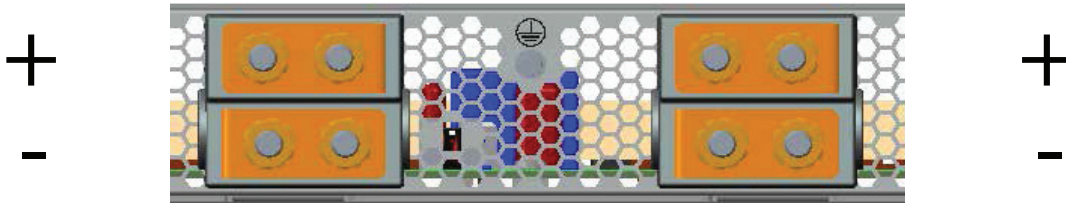

### PPR-1U-D & PPR-1U-E Output Terminal Block Configuration (Single Output, Configuration B)

All 4 power modules wired in parallel inside the power shelf, 6 kW available from each output terminal block set

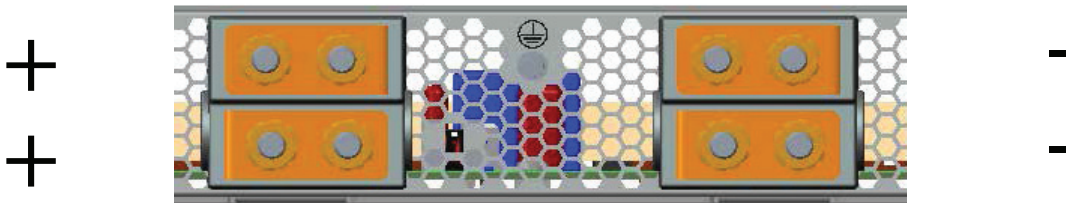

## MECHANICAL DRAWING

### PPR-1U, PPR-1U-A, PPR-1U-D - FRONT TO BACK AIRFLOW

units: inches [mm]

tolerance:  $\pm 0.02$  [0.50]

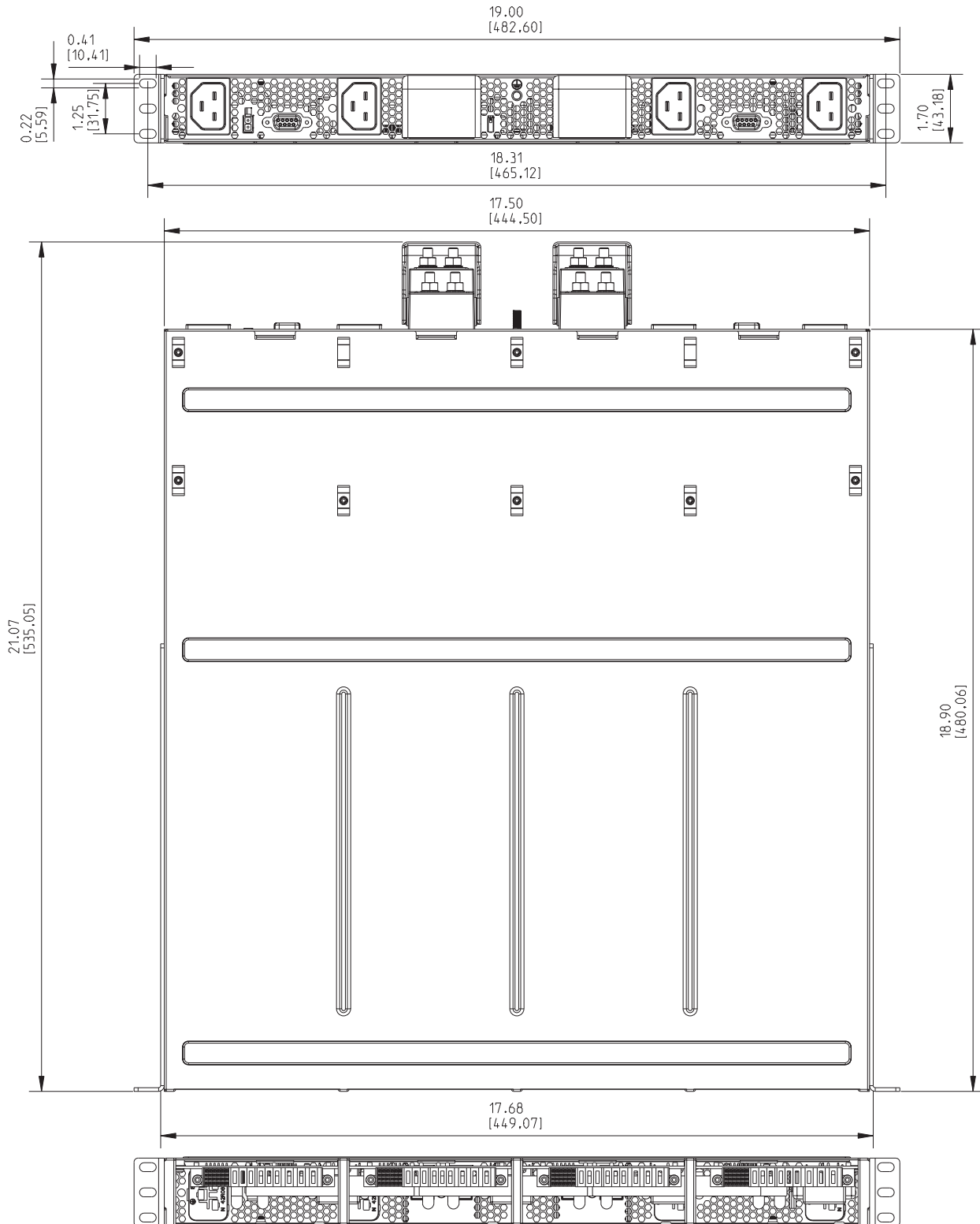

## MECHANICAL DRAWING (CONTINUED)

### PPR-1U-B, PPR-1U-C, PPR-1U-E - BACK TO FRONT AIRFLOW

units: inches [mm]  
tolerance:  $\pm 0.02$  [0.50]

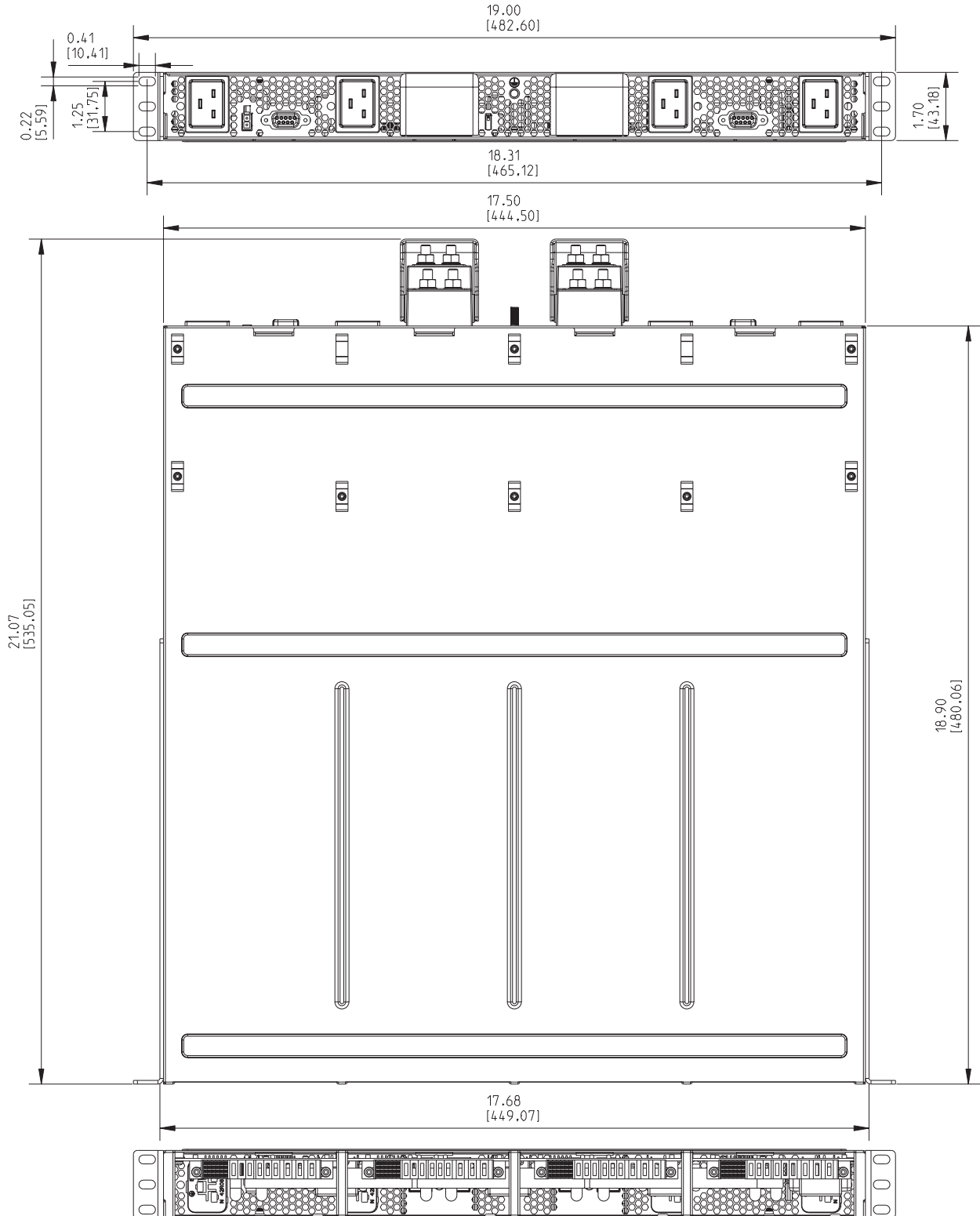

## MECHANICAL DRAWING (CONTINUED)

### Bracket Attachment

The mounting brackets are factory attached in the flush position. The mounting brackets can be repositioned by customer, however the #6-32 mounting screws to be reattached with typical torque of 6 to 8 in-lbs.

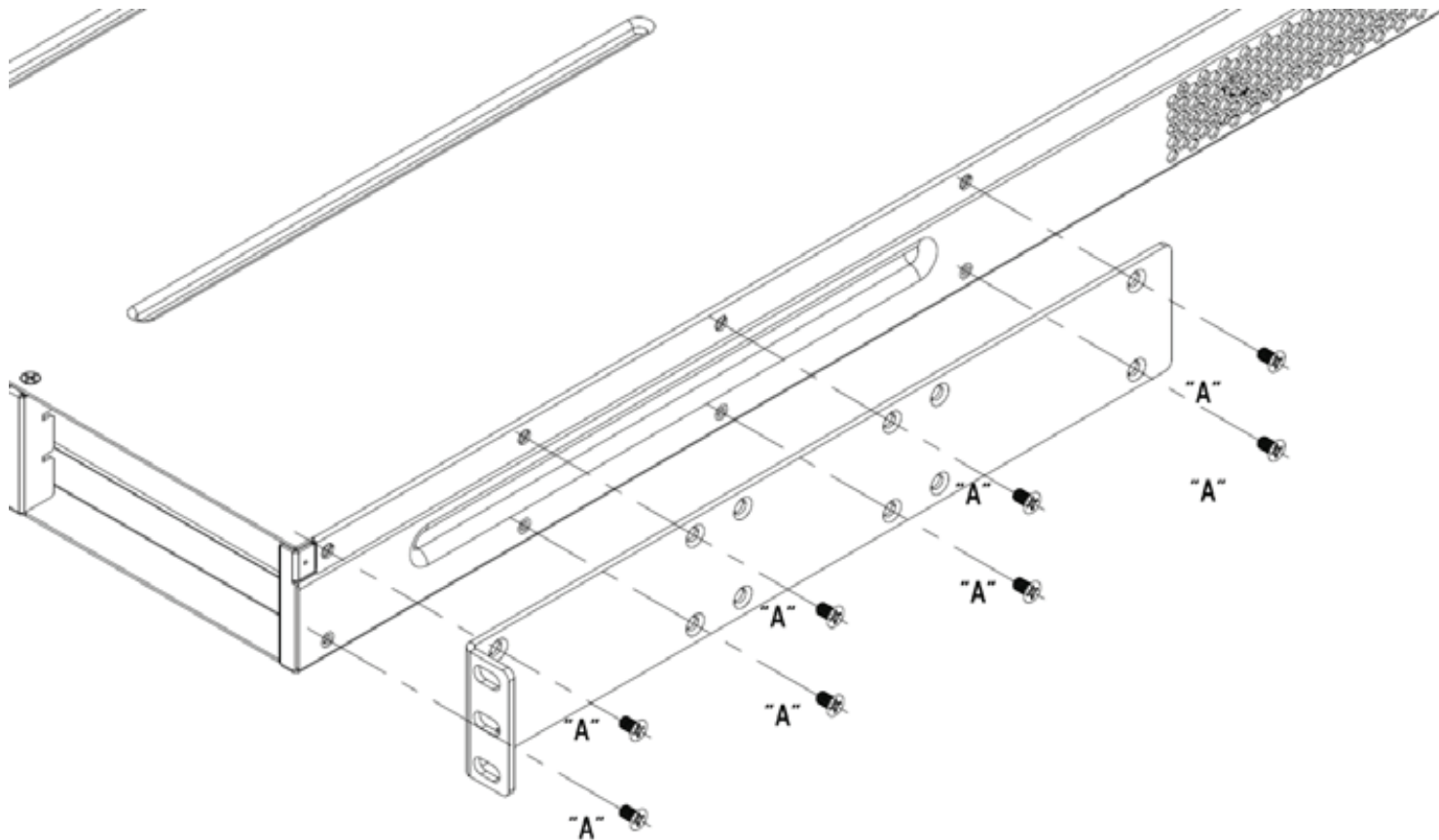

## CONNECTIONS

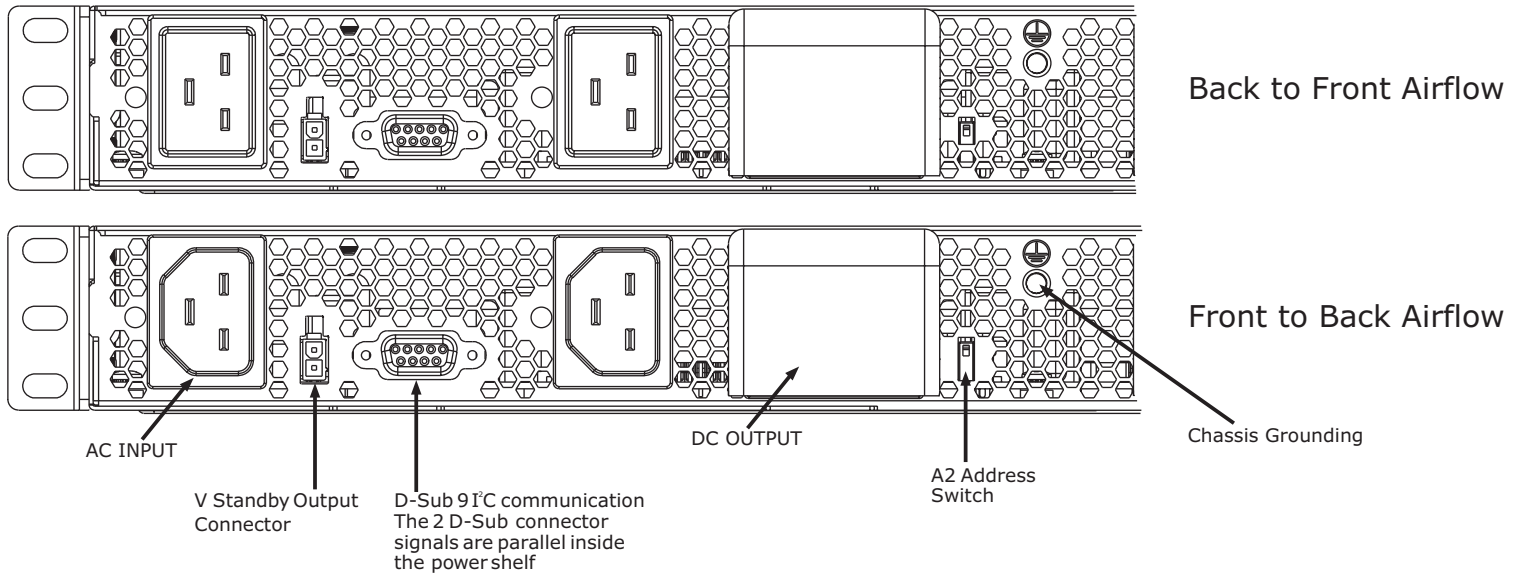

### AC Line Cord Connection

The power shelf is not shipped with AC line cords and the customer is responsible to provide its own AC line cords to meet the respective local electrical code requirements.

### Chassis Grounding

A ground stud is provided at the rear of the power shelf as shown below. Earth ground stud nut #10-32 to be torqued 16 to 19 in-lbs typical.

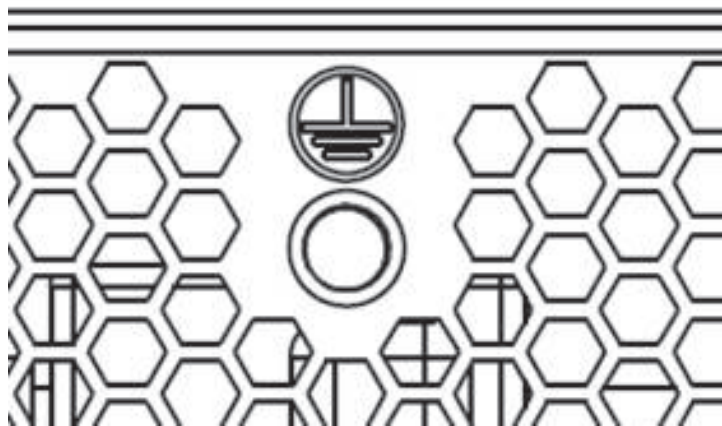



## CONNECTIONS (CONTINUED)

### DC Output Cable Connection

The Output and Return Cables (#2 AWG wire on 1/4" stud - not provided) connected to output studs provided at the rear of the power shelf as shown below.

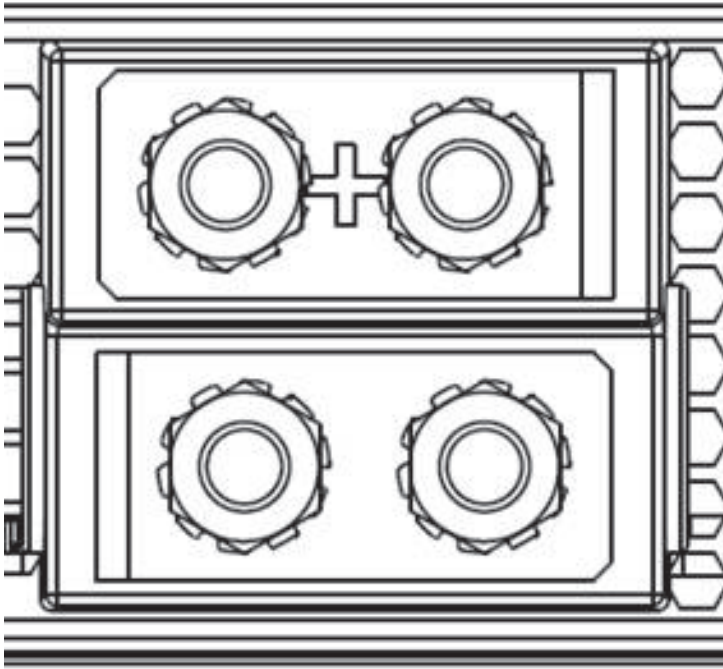

### Standby Output Connections

V Standby Output Connector, Mating Connector Molex 39-01-2020, terminals 39-00-0038

Connector - Pin#	Signal Name	Function
1 (lower position)	+3.3 STANDBY	+3.3 VDC +VE Output
2 (upper position)	+3.3 STANDBY RTN	+3.3 VDC -VE Output

### Signal Interface Connections (System to Shelf; Shelf to Shelf):

The shelf signals are provided with a 9 Pin female D-SUB connector for system communication and another 9 Pin female D-SUB connector for shelf to shelf communication:

	D-SUB 9 pin	System to Shelf	Shelf to Shelf
SDA	1	Yes	Yes
SCL	2	Yes	Yes
Not used	3	--	--
Vpgm	4	Yes	Yes
Vpgm Return	5	Yes	Yes
Digital Return	6	Yes	Yes
SMB Alert	7	Yes	Yes
Not used	8	--	--
I-Share	9	Yes	Yes



## CONNECTIONS (CONTINUED)

### A2 Address Switch Connections

A2 Address Switch		Address		
		A2	A1	A0
Down	Slot 1	0	0	0
	Slot 2	0	0	1
	Slot 3	0	1	0
	Slot 4	0	1	1
Up	Slot 1	1	0	0
	Slot 2	1	0	1
	Slot 3	1	1	0
	Slot 4	1	1	1

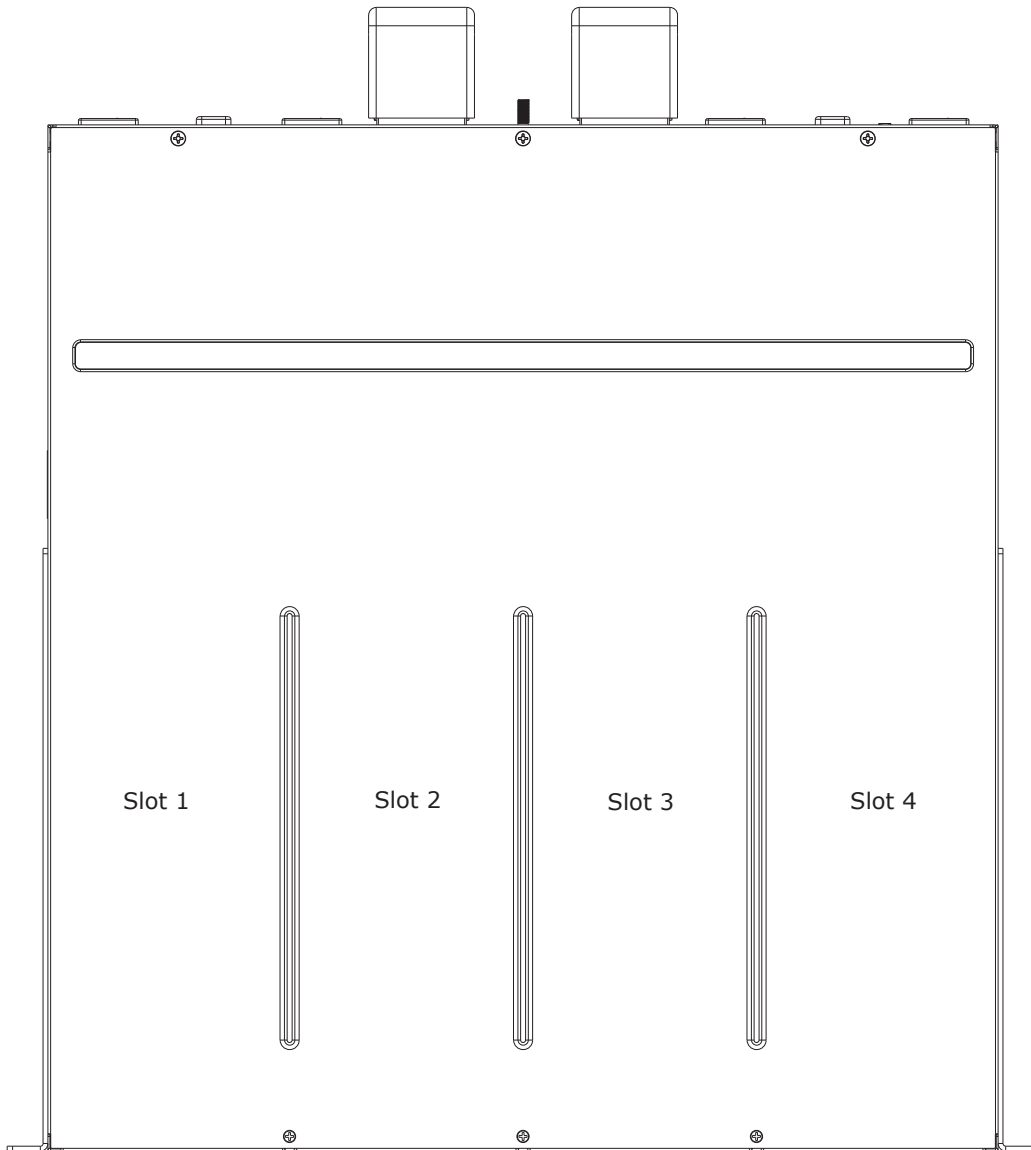

## ACCESSORIES

The PPR-1U Series requires the following additional accessories that can be purchased separately or as a kit.

Description	QTY	CUI Part Number	Vendor/Part Number
AC power line cordset, C22 type <sup>1</sup>	4		Schurter C21.6051.5002
AC power line cordset, C20 type <sup>2</sup>	4		Schurter C19.6009.5195
Aux Output Mating Connector	1		Molex 39-01-2020
Aux Output Contact Terminal	2		Molex 46055-0007
I <sup>2</sup> C dongle <sup>3</sup>	1		Microchip DV164122
I <sup>2</sup> C dongle to D sub 9 cable	1	014-157401-4	

Notes: 1. Used with PPR-1U, PPR-1U-A, PPR-1U-D  
 2. Used with PPR-1U-B, PPR-1U-C, PPR-1U-E  
 3. The PICKit Serial Analyzer is an USB-based tool used to direct communication between a PC and an external serial device. The kit comes complete with hardware (supporting I<sup>2</sup>C™, SMBus, SPI and USART protocols), an easy-to-use GUI (to configure and display communications) and a target demonstration board for out-of-the-box functionality.

### Accessory-kit-1

Description	QTY	Vendor/Part Number
AC power line cordset, C22 type	4	Schurter C21.6051.5002
Aux Output Mating Connector	1	Molex 39-01-2020
Aux Output Contact Terminal	2	Molex 46055-0007
I <sup>2</sup> C dongle <sup>3</sup>	1	Microchip DV164122
I <sup>2</sup> C dongle to D sub 9 cable	1	

Notes: 1. Compatible with PPR-1U, PPR-1U-A, PPR-1U-D

### Accessory-kit-2

Description	QTY	Vendor/Part Number
AC power line cordset, C20 type	4	Schurter C19.6009.5195
Aux Output Mating Connector	1	Molex 39-01-2020
Aux Output Contact Terminal	2	Molex 46055-0007
I <sup>2</sup> C dongle <sup>3</sup>	1	Microchip DV164122
I <sup>2</sup> C dongle to D sub 9 cable	1	

Notes: 1. Compatible with PPR-1U-B, PPR-1U-C, PPR-1U-E

## REVISION HISTORY

---

rev.	description	date
1.0	initial release	11/20/2015

The revision history provided is for informational purposes only and is believed to be accurate.



**Headquarters**  
20050 SW 112th Ave.  
Tualatin, OR 97062  
**800.275.4899**

Fax 503.612.2383  
**cui.com**  
techsupport@cui.com

CUI offers a two (2) year limited warranty. Complete warranty information is listed on our website.

CUI reserves the right to make changes to the product at any time without notice. Information provided by CUI is believed to be accurate and reliable. However, no responsibility is assumed by CUI for its use, nor for any infringements of patents or other rights of third parties which may result from its use.

CUI products are not authorized or warranted for use as critical components in equipment that requires an extremely high level of reliability. A critical component is any component of a life support device or system whose failure to perform can be reasonably expected to cause the failure of the life support device or system, or to affect its safety or effectiveness.