

SERIES: VSK-S2 | DESCRIPTION: AC-DC POWER SUPPLY
FEATURES

- up to 2 W continuous power
- compact board mount design
- universal input (85~305 Vac / 120~430 Vdc)
- single output from 3.3~24 V
- over current and short circuit protection
- UL/cUL and CE safety approvals
- efficiency up to 78%

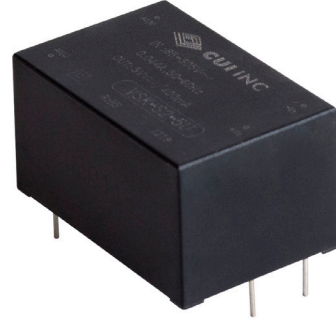

MODEL	output voltage	output current	output power	ripple and noise ¹	efficiency
	(Vdc)	max (mA)	max (W)	max (mVp-p)	typ (%)
VSK-S2-3R3U	3.3	600	2	200	65
VSK-S2-5U	5	400	2	200	70
VSK-S2-9U	9	222	2	200	72
VSK-S2-12U	12	167	2	200	76
VSK-S2-15U	15	133	2	200	76
VSK-S2-24U	24	83	2	200	78

Note: 1. At full load, 20 MHz bandwidth oscilloscope. See Test Configuration section.

PART NUMBER KEY

INPUT

parameter	conditions/description	min	typ	max	units
voltage		85 120		305 430	Vac Vdc
frequency		47		63	Hz
current	at 115 Vac at 230 Vac		44 25		mA mA
inrush current	at 115 Vac at 230 Vac		5 11		A A
leakage current				0.15	mA

OUTPUT

parameter	conditions/description	min	typ	max	units
maximum capacitave load	3.3 and 5 V output models 9 and 12 V output models 15 V output model 24 V output model			4,000 2,200 1,000 680	μ F μ F μ F μ F
line regulation				\pm 2	%
load regulation	10 ~ 100%			\pm 5	%
voltage accuracy	3.3 V model all other models			\pm 6 \pm 5	% %
switching frequency				100	kHz

PROTECTIONS

parameter	conditions/description	min	typ	max	units
over current protection		110			%
short circuit protection	continuous, auto restart				

SAFETY & COMPLIANCE

parameter	conditions/description	min	typ	max	units
isolation voltage	for 1 minute	3,000			Vac
safety approvals	UL 60950-1				
safety class	class II				
conducted emissions	CISPR22/EN55022 Class B				
radiated emissions	CISPR22/EN55022 Class B				
ESD	IEC/EN61000-4-2 class B, contact \pm 4kV, air \pm 8kV				
radiated immunity	IEC/EN61000-4-3 class A, 10V/m				
EFT/burst	IEC/EN61000-4-4 class B, \pm 2kV (external circuit required, see figure 3)				
surge	IEC/EN61000-4-5 class B, \pm 2kV (external circuit required, see figure 3)				
conducted immunity	IEC/EN61000-4-6 class A, 10 Vr.m.s				
PFM	IEC/EN61000-4-8 class A, 10 A/m				
voltage dips & interruptions	IEC/EN61000-4-11 class B, 0%-70%				
MTBF	25°C	300,000			hrs
RoHS	2011/65/EU				

ENVIRONMENTAL

parameter	conditions/description	min	typ	max	units
operating temperature	see derating curve	-25		70	°C
storage temperature		-40		85	°C
operating humidity	non-condensing			90	%
storage humidity	non-condensing			95	%

DERATING CURVES

1. output power vs. ambient temperature (85~305 Vac)

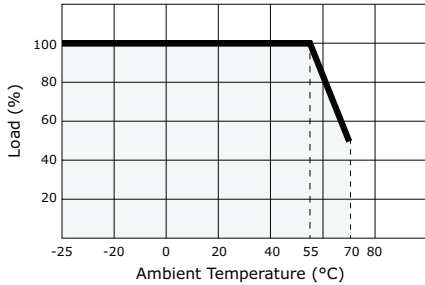

2. efficiency vs. output power (Vin=220Vac)

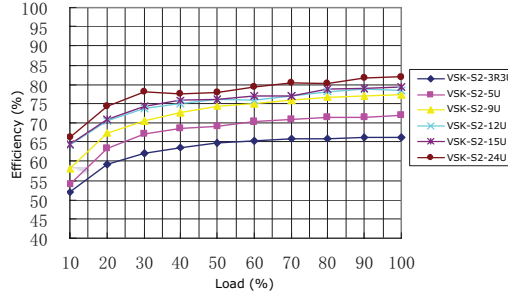

3. efficiency vs. input voltage (load=100%)

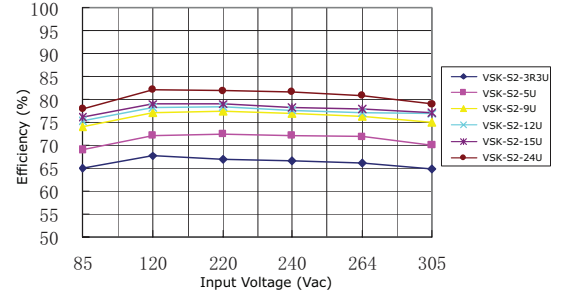

MECHANICAL

parameter	conditions/description	min	typ	max	units
dimensions	33.70 x 22.20 x 18.00 (1.327 x 0.874 x 0.708 inch)				mm
case material	UL94V-0				
weight			20		g

MECHANICAL DRAWING

units: mm [inches]
 tolerance: ±0.5 [±0.02]
 pin section tolerance: ±0.10 mm [±0.004]

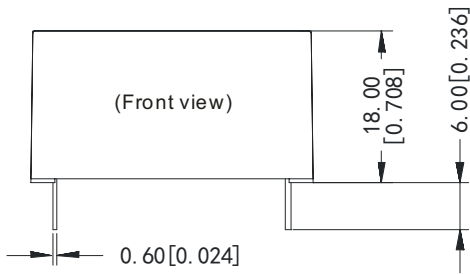

PIN CONNECTIONS	
PIN	FUNTION
1	AC(N)
2	AC(L)
3	-Vo
4	+Vo

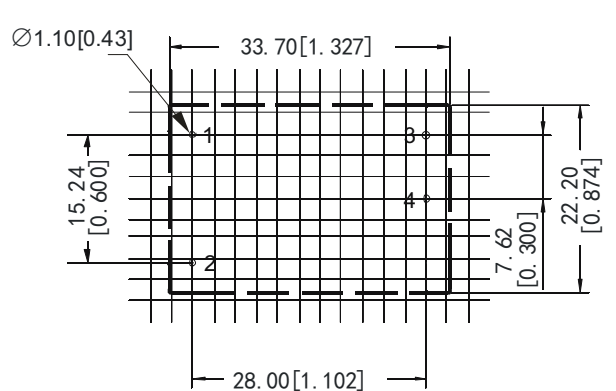
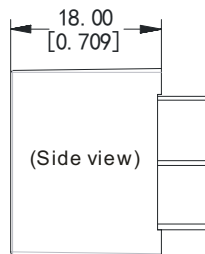
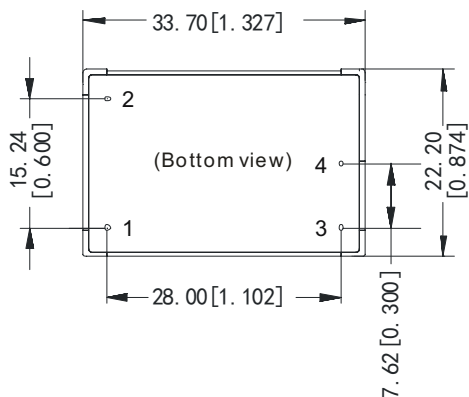

TEST CONFIGURATION

Figure 1

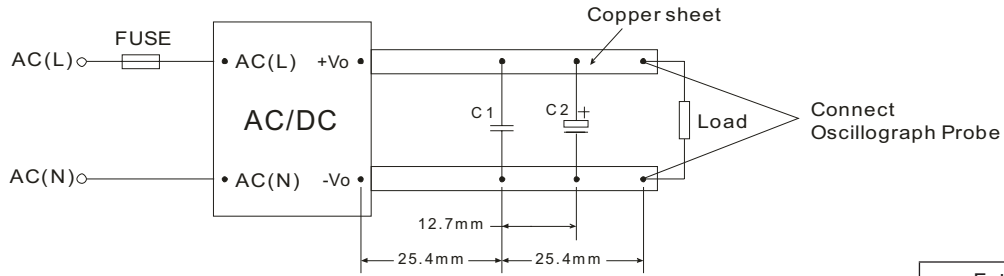

Table 1

External components	
C1	1 μ F ceramic
C2	10 μ F electrolytic

TYPICAL APPLICATION CIRCUIT

Figure 2

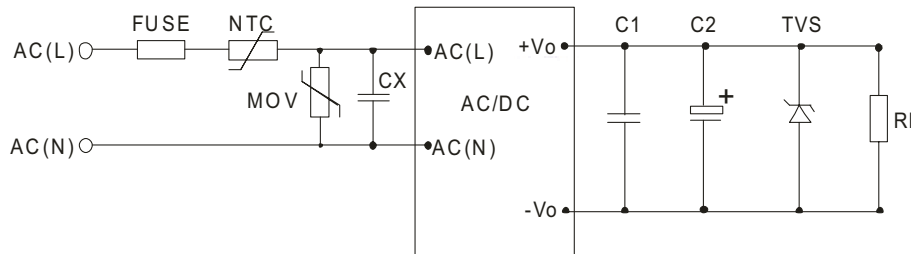
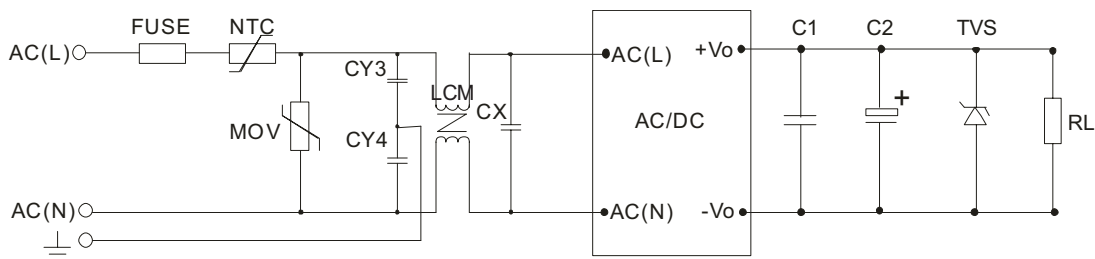

Table 2

Recommended external circuit components										
Model	FUSE	NTC	MOV	LCM	TVS ¹	C1 ²	C2 ³	CY3	CY4	CX
VSK-S2-3R3U	1A/300V, slow blow	5D-9	S14K350	10 mH	SMBJ7.0A	1 μ F/50V	220 μ F	2.2nF/400V	2.2nF/400V	0.1 μ F/305Vac
VSK-S2-5U	1A/300V, slow blow	5D-9	S14K350	10 mH	SMBJ7.0A	1 μ F/50V	220 μ F	2.2nF/400V	2.2nF/400V	0.1 μ F/305Vac
VSK-S2-9U	1A/300V, slow blow	5D-9	S14K350	10 mH	SMBJ12A	1 μ F/50V	120 μ F	2.2nF/400V	2.2nF/400V	0.1 μ F/305Vac
VSK-S2-12U	1A/300V, slow blow	5D-9	S14K350	10 mH	SMBJ20A	1 μ F/50V	120 μ F	2.2nF/400V	2.2nF/400V	0.1 μ F/305Vac
VSK-S2-15U	1A/300V, slow blow	5D-9	S14K350	10 mH	SMBJ20A	1 μ F/50V	120 μ F	2.2nF/400V	2.2nF/400V	0.1 μ F/305Vac
VSK-S2-24U	1A/300V, slow blow	5D-9	S14K350	10 mH	SMBJ30A	1 μ F/50V	68 μ F	2.2nF/400V	2.2nF/400V	0.1 μ F/305Vac

EMC RECOMMENDED CIRCUIT

Figure 3



- Notes:
1. See Table 2 for EMC components.
 2. TVS is a recommended component to protect post-circuits if converter fails.
 3. C1 is a ceramic capacitor used to filter high frequency noise.
 4. C2 is an electrolytic capacitor. We recommend using high frequency and low impedance electrolytic capacitors. For capacitance and current of capacitor please refer to the manufacturer's datasheet. Voltage derating of capacitor should be 80% or above.
 5. All specifications are measured at rated input voltage, rated output load, TA=25°C, and humidity < 75% unless otherwise specified.

REVISION HISTORY

rev.	description	date
1.0	initial release	04/19/2012
1.01	updated features	06/04/2012
1.02	V-Infinity branding removed	08/16/2012
1.03	updated derating curves and spec	11/12/2013

The revision history provided is for informational purposes only and is believed to be accurate.



CUI INC[®]

Headquarters
20050 SW 112th Ave.
Tualatin, OR 97062
800.275.4899

Fax 503.612.2383
cui.com
techsupport@cui.com

CUI offers a two (2) year limited warranty. Complete warranty information is listed on our website.

CUI reserves the right to make changes to the product at any time without notice. Information provided by CUI is believed to be accurate and reliable. However, no responsibility is assumed by CUI for its use, nor for any infringements of patents or other rights of third parties which may result from its use.

CUI products are not authorized or warranted for use as critical components in equipment that requires an extremely high level of reliability. A critical component is any component of a life support device or system whose failure to perform can be reasonably expected to cause the failure of the life support device or system, or to affect its safety or effectiveness.