

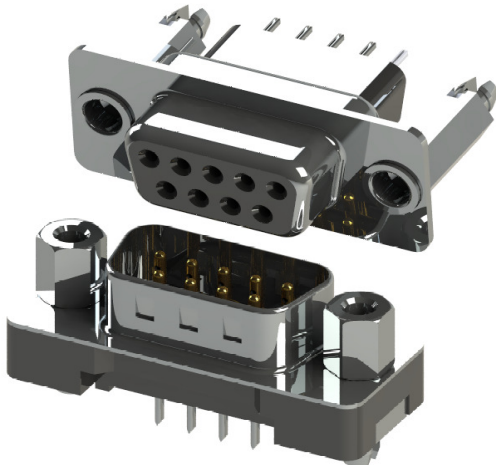

SERIES 627/628: D-SUB CONNECTOR

Plug and Receptacle, Vertical, PCB Mount, Plastic or Metal Body



- Both Low and High Profiles are available
- .109" (2.77mm) Contact Spacing x .112" (2.82mm) Row Spacing
- Plug and Receptacle in 9, 15, 25, 37 or 50 Contact Sizes (50 Contact Size Available only in Metal Body)
- Pin and Socket Contact Mating Design with P.C. Tail Termination
- Metal Shell Provides EMI/RFI Shielding, Plug Shell Indents provide Grounding and Additional Mating Retention
- Grounding Features include Two Prong Boardlock for Exceptional Retention to P.C. Board
- Mounting Options for Panel Mount or Connector Mating include Through Hole, Threaded Inserts and Threaded Standoffs
- D-Shaped Connector Mating Outline provides Polarization
- Design based on Requirements of MIL-C-24038, EIA RS-232 and RS-449

Specifications:

Insulator Material	Thermoplastic Polyester, UL 94V-0, Chemical Resistant, Color: Black
Contact Material	Plug (Pins): Brass Receptacle (Socket): Brass or Phosphor Bronze
Contact Plating	Selective Gold (See Ordering Code) over Nickel for the Mating Area, Tin Plating for Tail Area
Ferrite Specs:	20dB MIN @30 MHz, 30dB MIN @50 MHz, and 50dB MIN @100 MHz
Shell Material	Nickel Plated Steel (Optional Tin Plating)
Current Rating	5A Per Contact
Contact Resistance	10 Milliohms MAX
Insulation Resistance	5000 Megohms MIN
Dielectric Voltage	1000V AC rms at Sea Level
Operating Temp.	-55°C To +105°C
Mating and Unmating Force	1oz To 10oz (0.28N To 2.78N) Per Contact Position

**50 Contact Size Only Available in Metal Body

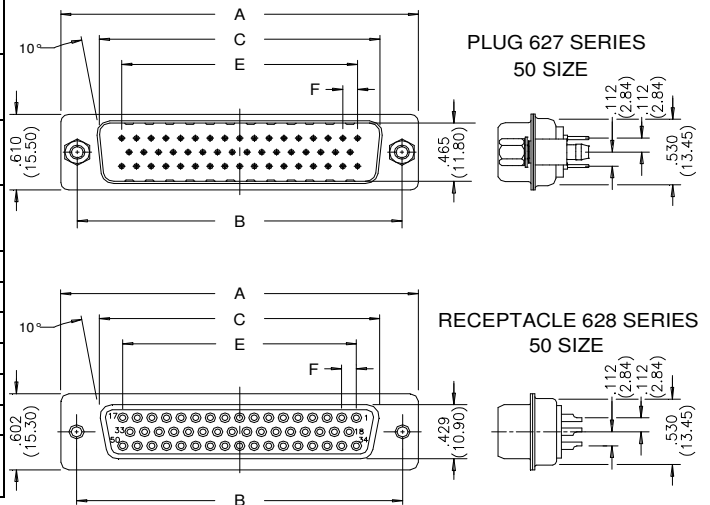

Ordering Code: 627-025-220-043

SERIES:

627: PLUG (PIN)
628: RECEPTACLE (SOCKET)

NO. OF CONTACTS:

009 - 9 CONTACTS 025 - 25 CONTACTS
015 - 15 CONTACTS 037 - 37 CONTACTS
050 - 50 CONTACTS (METAL BODY ONLY)

CONTACT FINISH CODE:

2 - GOLD FLASH PLATING
3 - 15 MICROINCHES OF GOLD PLATING
6 - 30 MICROINCHES OF GOLD PLATING

TERMINATION:

010 - CRIMP AND LOAD (CABLE ASSEMBLY)

CONTACT CODE:

20 - .105" (2.67mm) TO .160" (4.06mm) PC TAIL
21 - .125" (3.18mm) TO .165" (4.20mm) PC TAIL
22 - SOLDER CUP TAIL
26 - PRESS FIT CONTACT
28 - .110" (2.80mm) FERRITE FILTER

MOUNTING OPTIONS:

- 0 - NO CONTACTS (CRIMP AND LOAD ONLY)
- 1 - Ø.125" (Ø3.18MM) THROUGH HOLE
- 2 - 4-40 UNC THREADED INSERT
- 3 - 4-40 UNC THREADED STANDOFF
- 4 - 4-40 UNC THREADED INSERT WITH DIP SOLDER PRONGS
- 5 - 4-40 UNC THREADED STANDOFF WITH DIP SOLDER PRONGS
- 6 - 4-40 UNC THREADED INSERT WITH BOARDLOCKS
- 7 - 4-40 UNC THREADED STANDOFF WITH BOARDLOCKS
- 8 - 4-40 UNC THREADED FIXED STANDOFF

GROUNDING FEATURE:

- 1 - LOW PROFILE PLASTIC BODY
- 4 - LOW PROFILE METAL BODY
- 5 - HIGH PROFILE (METAL BODY ONLY)

CRIMP AND LOAD TERMINATION ONLY:

- 0 - NO HARDWARE
- 1 - .098" (2.49mm) CLINCH NUT (BOARDSIDE)
- 2 - .236" (6.00mm) CLINCH NUT (BOARDSIDE)
- 3 - .236" (6.00mm) CLINCH NUT (MATING SIDE)

MATERIAL CODE:

- 0 - BRASS (627); PHOSPHOR BRONZE (628)
- 1 - BRASS (628 ONLY)
- 5 - BRASS, HIGH TEMP INSULATOR (627)
- PHOSPHOR BRONZE, HIGH TEMP INSULATOR (628)
- 6 - BRASS, HIGH TEMP INSULATOR (628 ONLY)

CRIMP AND LOAD TERMINATION ONLY:

- 2 - TIN PLATED SHELL
- 3 - NICKEL PLATED SHELL



SERIES 627/628: D-SUB CONNECTOR

Plug and Receptacle, Vertical, PCB Mount, Plastic or Metal Body

LOW PROFILE

PLUG 627 SERIES

HIGH PROFILE

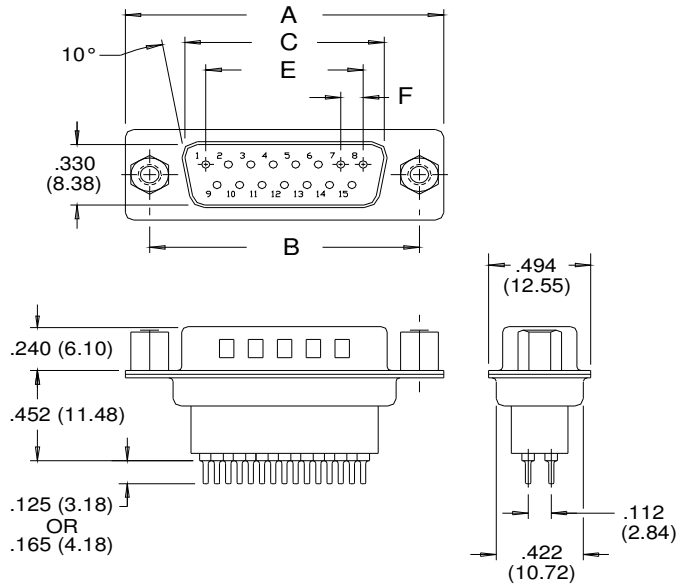
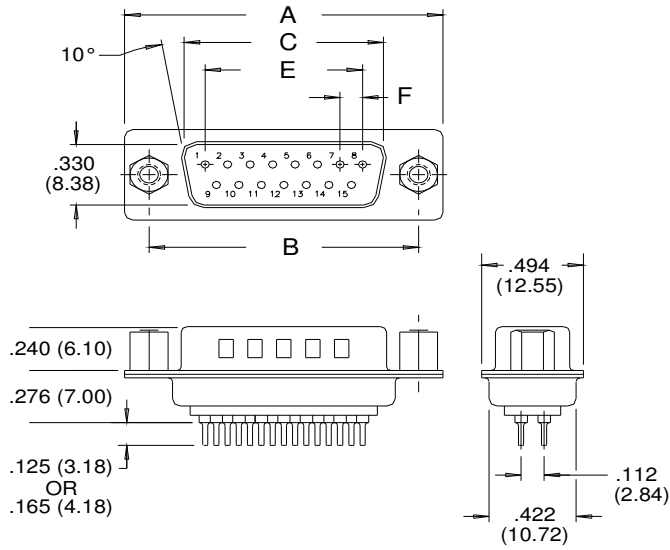

RECEPTACLE 628 SERIES

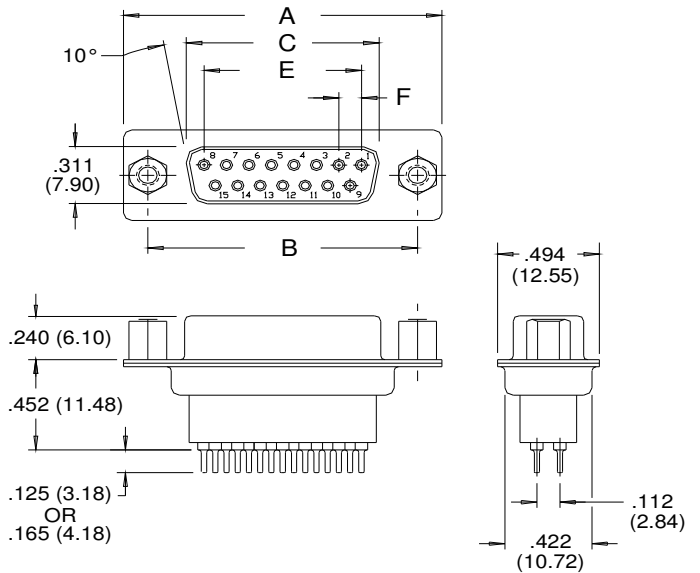
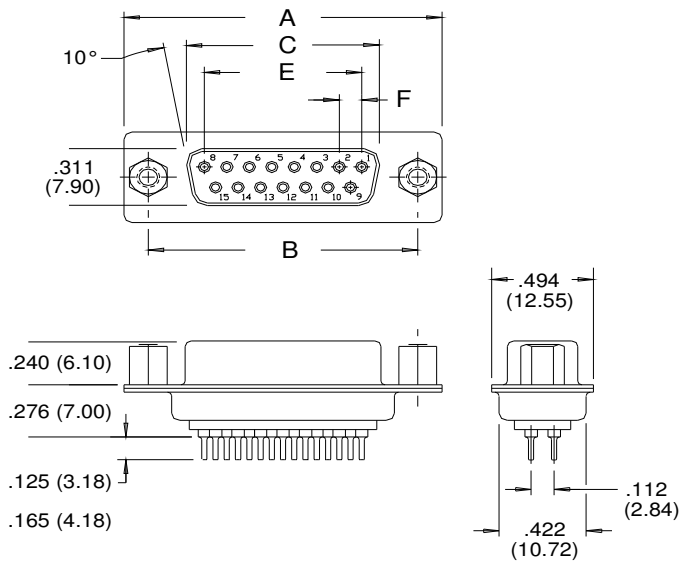

NUMBER OF CONTACTS	A		B		C PLUG		C RECEPTACLE		E		F	
	Inch	(mm)	Inch	(mm)	Inch	(mm)	Inch	(mm)	Inch	(mm)	Inch	(mm)
9	1.214	(30.84)	.984	(24.99)	.667	(16.92)	.640	(16.26)	.432	(10.97)	.108	(2.74)
15	1.545	(39.24)	1.312	(33.32)	.994	(25.25)	.967	(24.56)	.756	(19.20)	.108	(2.74)
25	2.088	(53.04)	1.852	(47.04)	1.534	(38.96)	1.508	(38.30)	1.304	(33.12)	.109	(2.76)
37	2.730	(69.34)	2.500	(63.50)	2.182	(53.08)	2.156	(54.76)	1.956	(49.68)	.109	(2.76)
50	2.645	(67.18)	2.406	(61.11)	2.080	(52.83)	2.059	(52.30)	1.740	(44.20)	.109	(2.76)



SERIES 627/628: D-SUB CONNECTOR

Plug and Receptacle, Vertical, PCB Mount, Plastic or Metal Body

PLASTIC BODY

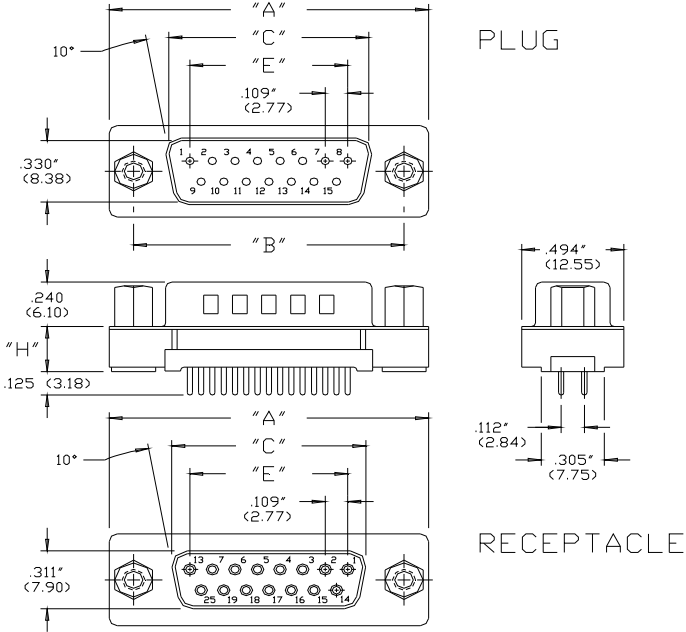

METAL BODY

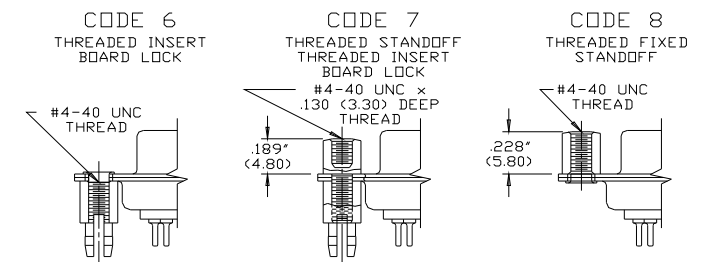
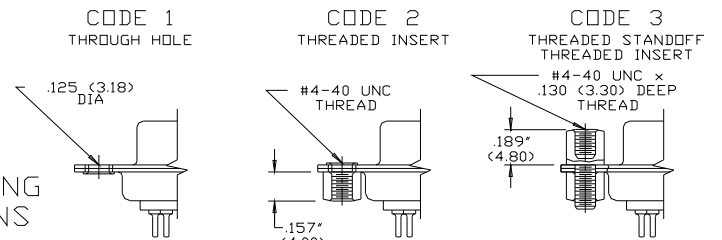
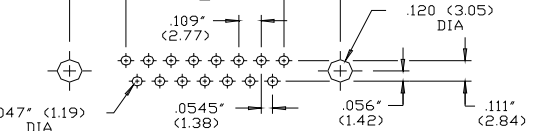
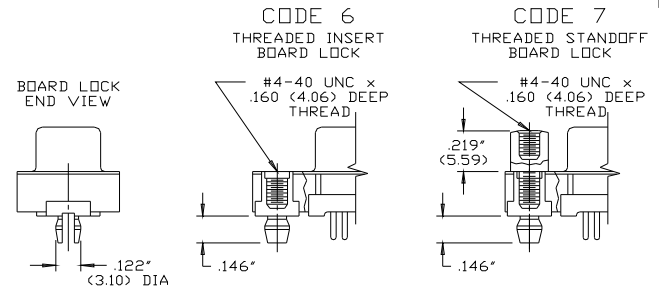
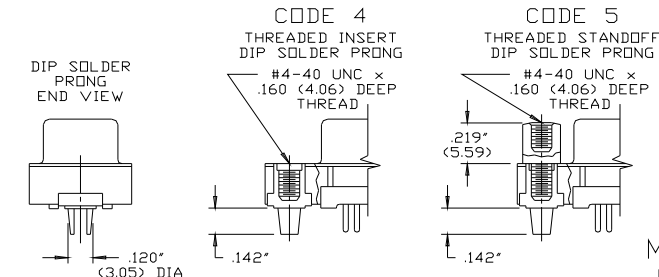
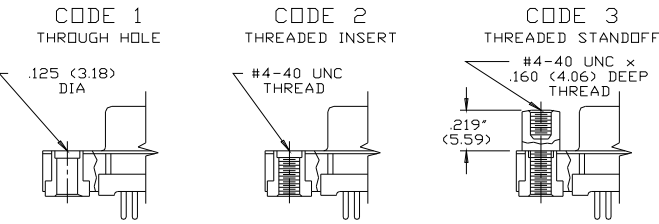
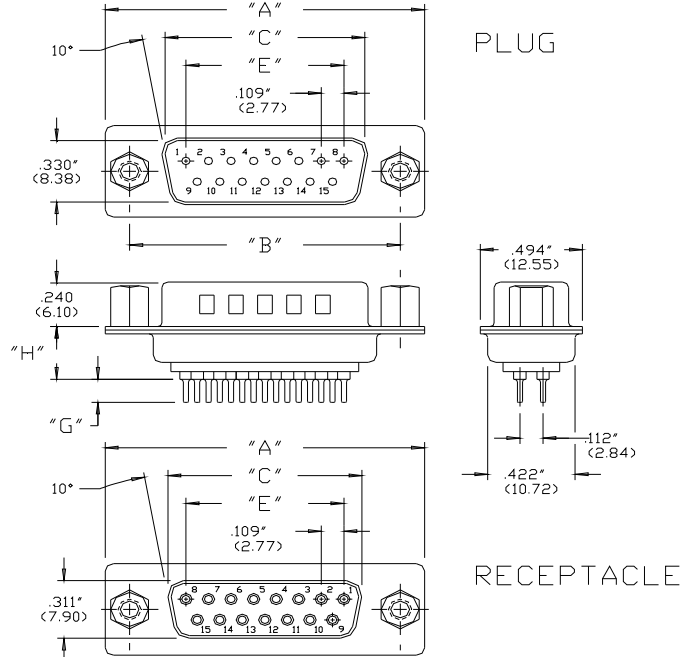

MOUNTING OPTIONS