

TOLERANCE UNLESS OTHERWISE SPECIFIED IN MM:	ANGLE	X°
0		
± 0.38		
± 0.25		
± 0.10		

THIS IS A C.A.D. GENERATED DRAWING
DO NOT MAKE MANUAL REVISIONS TO MASTER.

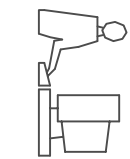

ISSUE NUMBER	1
ORIGINAL	

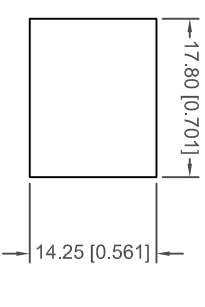
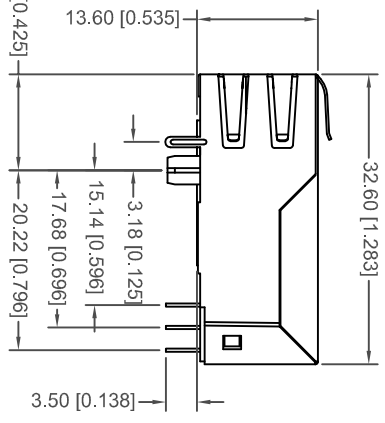
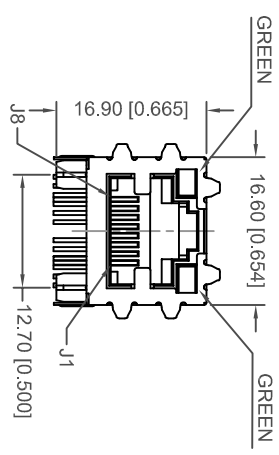

RECOMMENDED PANEL OPENING

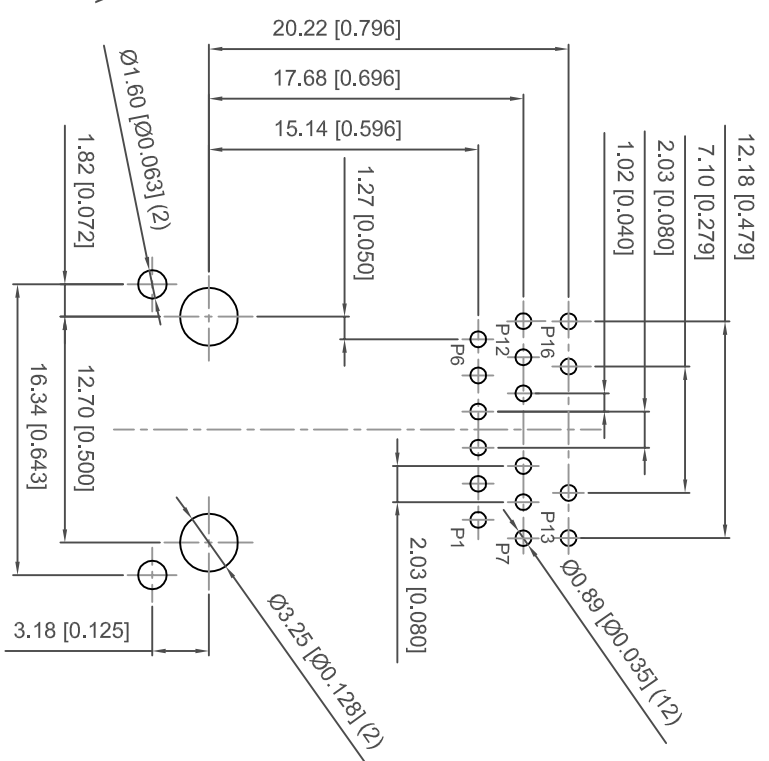
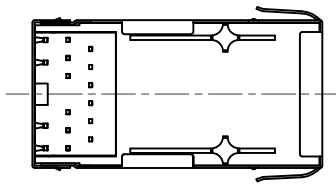

RECOMMENDED P.C.B. LAYOUT
TOLERANCE: ±0.08[±0.003]

- NOTES:
1. MATERIALS:
HOUSING: THERMOPLASTIC, UL 94V-0, COLOR: BLACK
SHIELD: BRASS WITH NICKEL PLATING
CONTACTS: COPPER ALLOY PLATED WITH GOLD PLATING AND TIN IN SOLDER AREA

PART NO	GOLD PLATING THICKNESS
A60-112-233P471	GOLD FLASH PLATING
A60-113-233P471	15 MICRO INCHES OF GOLD
A60-114-233P471	30 MICRO INCHES OF GOLD
A60-115-233P471	50 MICRO INCHES OF GOLD

2. OPERATING TEMPERATURE: 0°C TO +70°C
3. STORAGE TEMPERATURE: -40°C TO +85°C
4. MATE WITH MODULAR PLUG CONFORMING TO FCC PART 68, SUBPART F.
5. RECOMMENDED TEMPERATURE FOR WAVE SOLDERING IS 260°C MAX, 10 SEC MAX
6. DIMENSION: MM [INCHES]

RJ45 MAGNETIC JACK WITH LED, 12P, 8C SHIELDED, 10/100/1000 Mbps- FILTER

ACAD REFERENCE NO.: A60-112-233P471

DRAWN: R.STA.MONICA DATE: MAR.23/2012

CHECKED: DATE:

PART NUMBER SEE NOTE SHEET 1 OF 2

DRAWING NUMBER A60-112-233P471 ISSUE 1



THIS SERIES FULLY CONFORMS TO THE
EUROPEAN UNION DIRECTIVES 2002/95/EC
AND 2002/96/EC FOR ROHS COMPLIANCY.

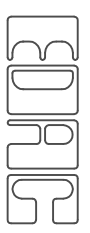

EDAC INC
TORONTO, ONTARIO
CANADA
YOUR CONNECTION TO QUALITY & SERVICE

THESE DRAWINGS AND SPECIFICATIONS
ARE THE PROPERTY OF EDAC INC. AND
SHALL NOT BE REPRODUCED OR COPIED
OR USED AS THE BASIS FOR THE
MANUFACTURE OR SALE OF APPARATUS
WITHOUT WRITTEN PERMISSION.

ELECTRICAL CIRCUIT:

TOLERANCE UNLESS OTHERWISE SPECIFIED IN MM:		ANGLE	X°
0	± 0.38		
0.0	± 0.25		
0.00	± 0.10		

THIS IS A C.A.D. GENERATED DRAWING
DO NOT MAKE MANUAL REVISIONS TO MASTER.

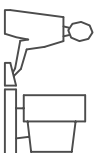

CONNECTOR SOLDER SIDE

RJ45 CONTACT SIDE

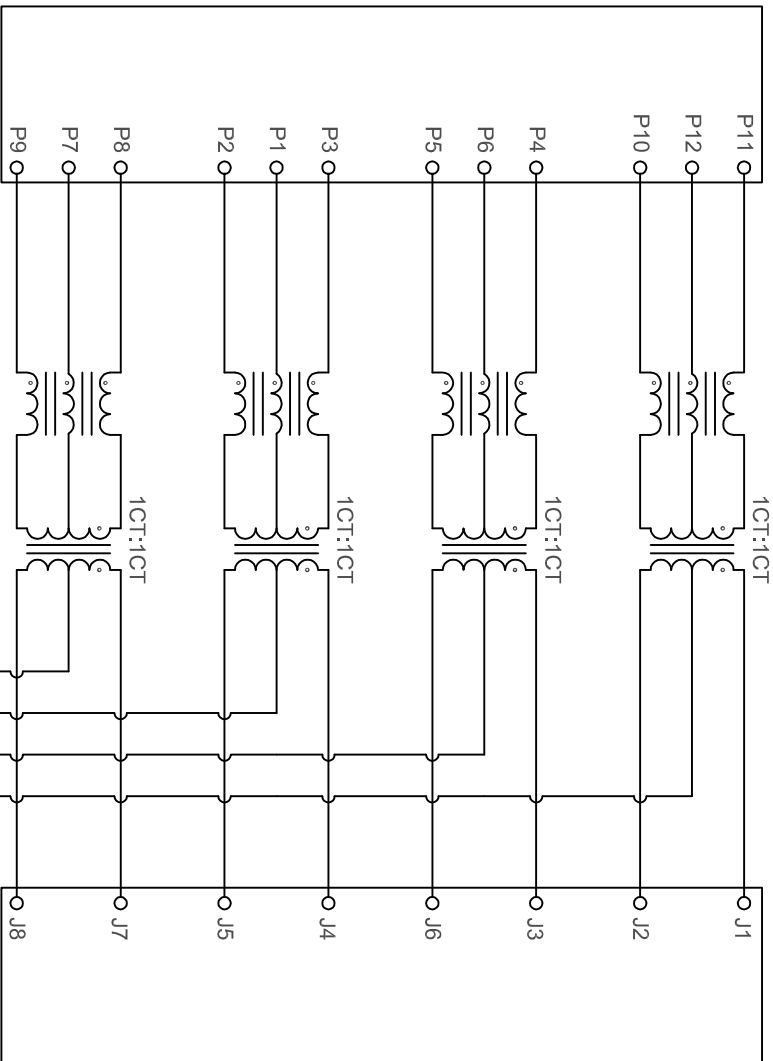

TEST NOTES:(25±5°C)

- TR:(100KHz,0.1V): 100%
PINS:(P8,P9):(J7,J8)=1:1±3%;(P3,P2):(J4,J5)=1:1±5%
PINS:(P4,P5):(J3,J6)=1:1±5%;(P1,P10):(J1,J2)=1:1±5%
- LX:(100KHz,100mV,8mA, DC Bias) 100%
PINS:(P8,P9),(P3,P2),(P4,P5),(P1,P10)=350uH MINIMUM
- DC RESISTANCE: 1.2 OHMS MAXIMUM
- INSERTION LOSS:
-1.0 dB MINIMUM AT 1MHZ TO 100MHZ;
-1.2 dB MINIMUM AT 100MHZ TO 125MHZ;
- RETURN LOSS:
-16dB MAXIMUM AT 1MHZ TO 40MHZ;
-12dB MAXIMUM AT 40MHZ TO 60MHZ
-10dB MAXIMUM AT 60MHZ TO 80MHZ
-8dB MAXIMUM AT 80MHZ TO 100MHZ
- CROSS TALK:
-30dB MINIMUM AT 1MHZ TO 100MHZ
- COMMON TO COMMON MODE ATTENUATION:
-30dB MINIMUM AT 1MHZ TO 100MHZ
- ISOLATION PHY SIDE TO LINE SIDE: 2250 VDC



LED SPECIFICATIONS (WITH FORWARD CURRENT OF 20 mA)			
STANDARD LED	WAVELENGTH	FORWARD V (MAX)	TYP
GREEN	565 nm	2.4 V	2.2 V

**RJ45 MAGNETIC JACK WITH LED, 12P, 8C
SHIELDED, 10/100/1000 Mbps- FILTER**

ACAD REFERENCE NO.:	A60-112-233P471
DRAWN: R.STA.MONICA	DATE: MAR.23/2012
CHECKED:	DATE:

PART NUMBER	SEE NOTE	SHEET 2 OF 2
DRAWING NUMBER	A60-112-233P471	ISSUE
		1



THIS SERIES FULLY CONFORMS TO THE EUROPEAN UNION DIRECTIVES 2002/95/EC AND 2002/96/EC FOR ROHS COMPLIANCY.



EDAC INC
TORONTO, ONTARIO
CANADA

YOUR CONNECTION TO QUALITY & SERVICE

THESE DRAWINGS AND SPECIFICATIONS ARE THE PROPERTY OF EDAC INC. AND SHALL NOT BE REPRODUCED OR COPIED OR USED AS THE BASIS FOR THE MANUFACTURE OR SALE OF APPARATUS WITHOUT WRITTEN PERMISSION.