

ISL9440CEVAL1Z Evaluation Board

The ISL9440CEVAL1Z evaluation board features the ISL9440C. The ISL9440C is quad-output controller that integrates three PWM synchronous buck controllers and one low-dropout linear regulator controller. The ISL9440C offers programmable soft-start, independent enable functions and integrates OV/OC/OT protection. The current mode control architecture and internal compensation network keep peripheral component counts minimized. 600kHz switching frequency can minimize inductor size while the strong gate driver is able to deliver 12A to each PWM channel.

Table 1 shows the difference in terms of ISL944xx family features.

TABLE 1. FEATURES OF ISL944xx FAMILY

PART NUMBER	EARLY WARNING	SWITCHING FREQUENCY (kHz)	SOFT-STARTING TIME (ms)
ISL9440	YES	300	1.7
ISL9440A	YES	600	1.7
ISL9441	NO	300	1.7
ISL9440B	YES	300	PROGRAMMABLE
ISL9440C	YES	600	PROGRAMMABLE

The ISL9440CEVAL1Z is easy to set up to evaluate the performance of the ISL9440C. Please refer to the “Electrical Specifications” for typical performance summary.

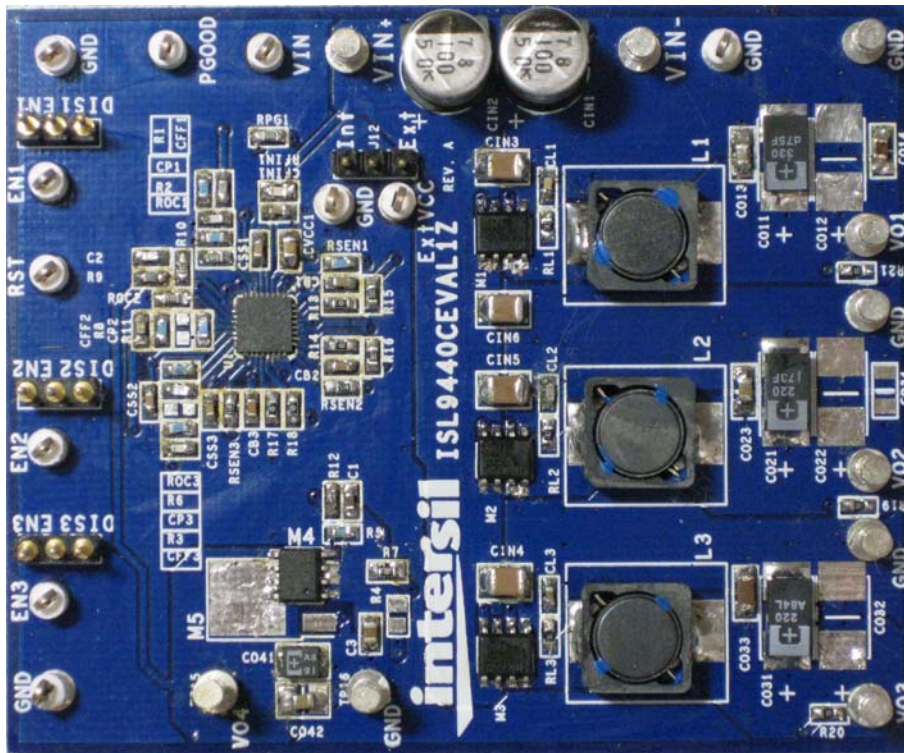

FIGURE 1. ISL9440CEVAL1Z EVALUATION BOARD

Application Note 1482

Electrical Specifications Recommended operation conditions unless otherwise noted. Refer to schematic and typical performance curves.

PARAMETER	TEST CONDITIONS	MIN	TYP	MAX	UNITS
V _{IN}	All outputs are in regulation	6.0	12	16	V
V _{OUT1}		0.97	1.00	1.03	V
V _{OUT2}		3.25	3.32	3.4	V
V _{OUT3}		4.85	5.0	5.15	V
V _{OUT4}		2.43	2.50	2.57	V
PWM1 Rated Current	V _{IN} = 12V, T _A = +25°C, No forced airflow, All three PWM outputs are fully loaded		6	7	A
PWM2 Rated Current			6	7	A
PWM3 Rated Current			4	5	A
LDO Rated Current	R7 = 0Ω, R4 is not populated		0.8	1.0	A
V _{OUT1} Peak-to-Peak Ripple	V _{IN} = 12V, All three PWM outputs are fully loaded, Oscilloscope is with full bandwidth		19.8		mV _{P-P}
V _{OUT2} Peak-to-Peak Ripple			59.6		mV _{P-P}
V _{OUT3} Peak-to-Peak Ripple			66.5		mV _{P-P}

What's Inside

The Evaluation Board Kit contains the following materials:

- The ISL9440CEVAL1Z
- The ISL9440B, ISL9440C datasheet
- This EVAL KIT document

Recommended Equipment

The following materials are recommended to perform testing:

- 0V to 20V Power Supply with at least 10A Source Current Capability
- Three Electronic Loads Capable of Sinking Current up to 7A
- Digital Multimeters (DMMs)
- 100MHz Quad-Trace Oscilloscope
- Signal Generator (for load transient tests)

Quick Test Guide

1. Ensure that the circuit is correctly connected to the supply and electronic loads prior to applying any power. Please refer to Figure 2 for proper set-up.
2. Connect Jumpers J3, J4 and J5 in the ENx positions.
3. Turn on the power supply
4. Adjust input voltage V_{IN} within the specified range and observe output voltage. The output voltage variation should be within 3%.
5. Adjust load current within the specified range and observe output voltage. The output voltage variation should be within 3%.
6. Use oscilloscope to observe output voltage ripple and Phase node ringing. For accurate measurement, refer to Figure 3 for proper test set-up.

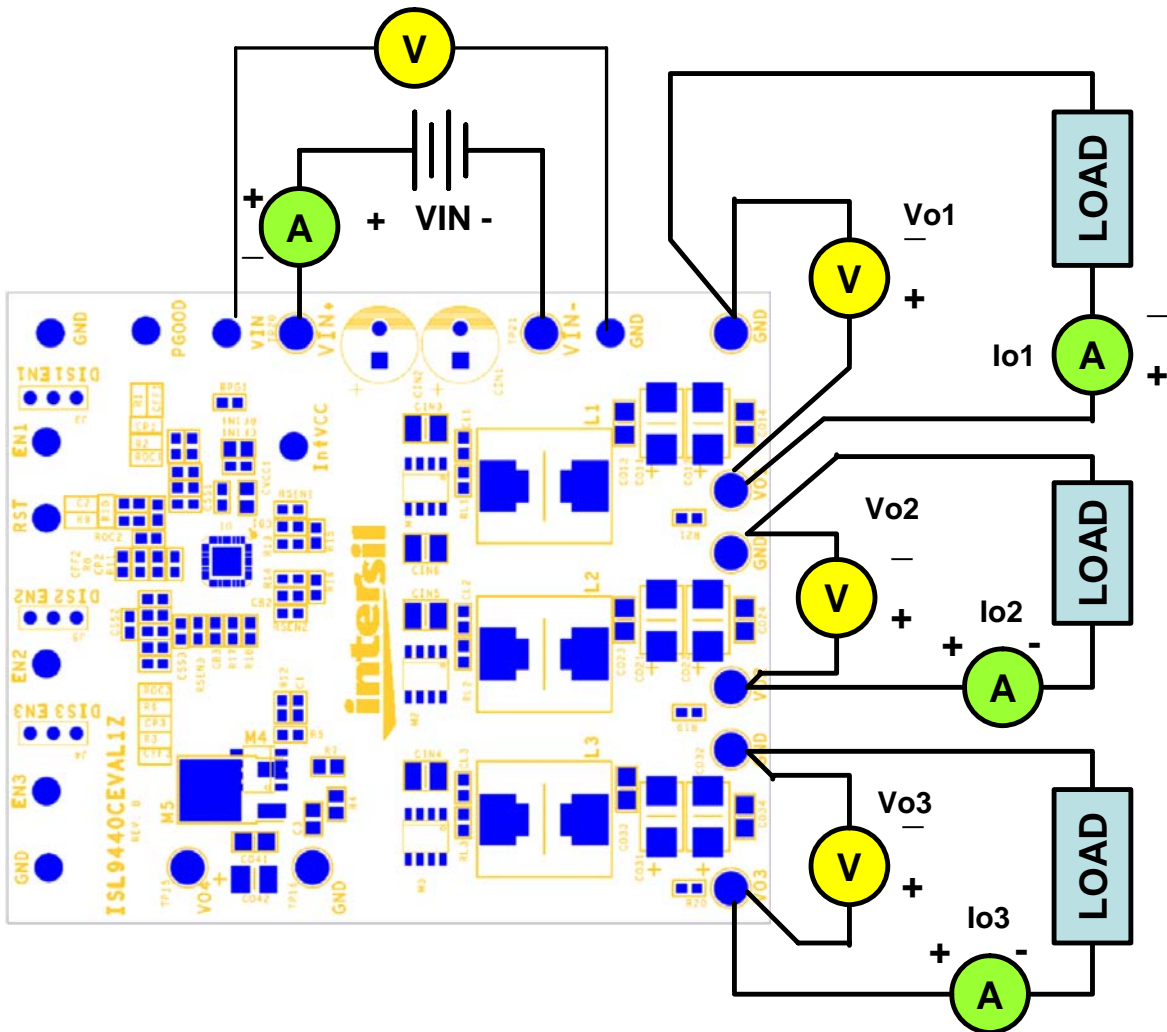

FIGURE 2. PROPER TEST SET-UP

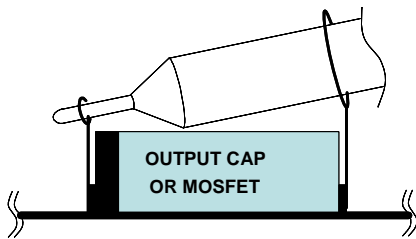

FIGURE 3. PROPER PROBE SET-UP TO MEASURE OUTPUT RIPPLE AND PHASE NODE RINGING

Load Transient Circuit Set-up

1. Select a SOIC8 N-Channel MOSFET with V_{DS} breakdown > 20V.
2. Install the load transient circuit as indicated on the schematic. Refer to Figure 4 for detail.
3. R27, R22 and R25 are 10k Ω resistors for discharging the MOSFET gates.
4. R26, R23 and R24 are current sensing resistors to monitor the load step. For accurate measurement, please use 5% tolerance sensing resistor or better. To alleviate thermal stress, use 0.1 Ω or smaller resistance. The resistance of the sensing resistors sets the current scale on the oscilloscope.
5. Apply pulse square waveform across R27, R22 or R25. The duty cycle of the pulse waveform should be small (<5%) to limit thermal stress on current sensing resistor and the MOSFETs (M8, M6 or M7)
6. The amplitude of the clock sets the current step amplitude. Adjust the clock amplitude and slew rate to set the current step and slew rate.
7. Monitor overshoot and undershoot at corresponding output.

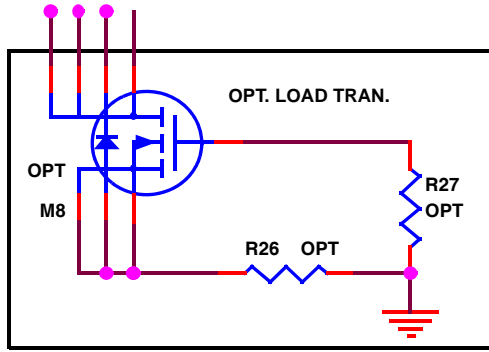

FIGURE 4. LOAD TRANSIENT CIRCUIT FOR PWM1

Typical Evaluation Board Performance Curves

$V_{IN} = 12V$, Unless Otherwise Noted.

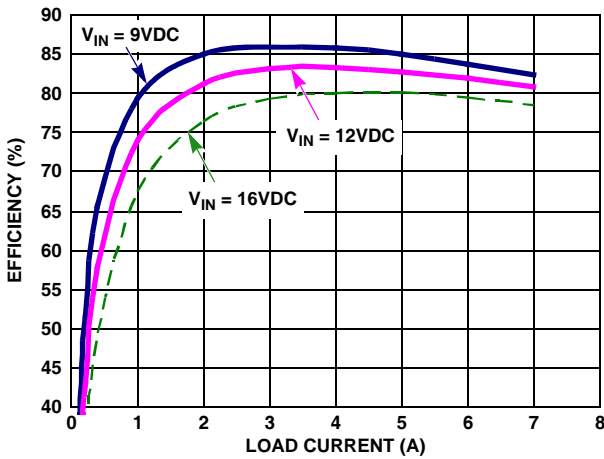

FIGURE 5. PWM1 EFFICIENCY vs LOAD ($V_O = 1.0V$)

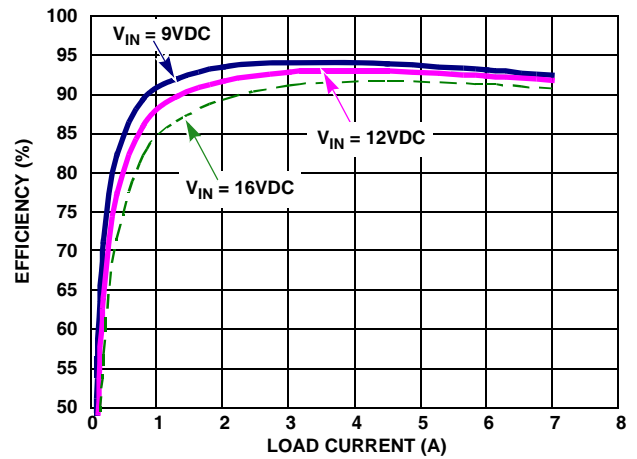

FIGURE 6. PWM2 EFFICIENCY vs LOAD ($V_O = 3.3V$)

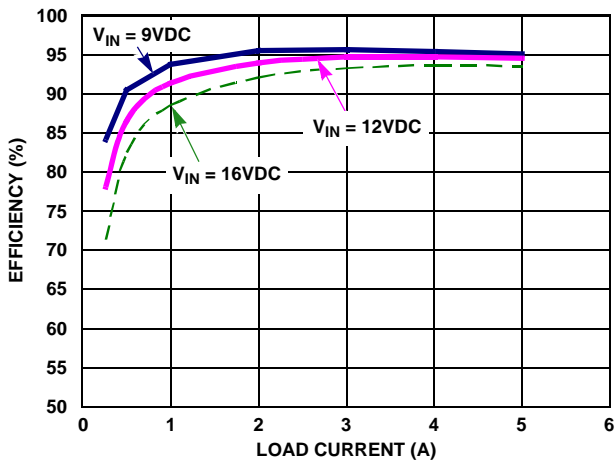

FIGURE 7. PWM3 EFFICIENCY vs LOAD ($V_O = 5.0V$)

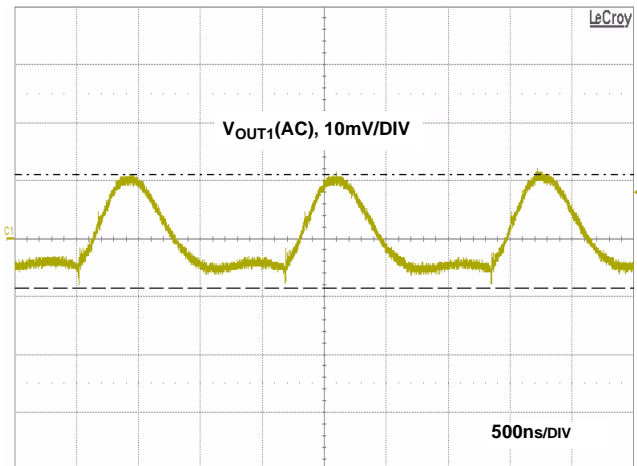

FIGURE 8. PWM1 OUTPUT RIPPLE UNDER MAX LOAD ($V_{IN} = 12V$, $I_{O1} = I_{O2} = 6A$, $I_{O3} = 4A$, FULL BANDWIDTH)

Typical Evaluation Board Performance Curves

$V_{IN} = 12V$, Unless Otherwise Noted. (Continued)

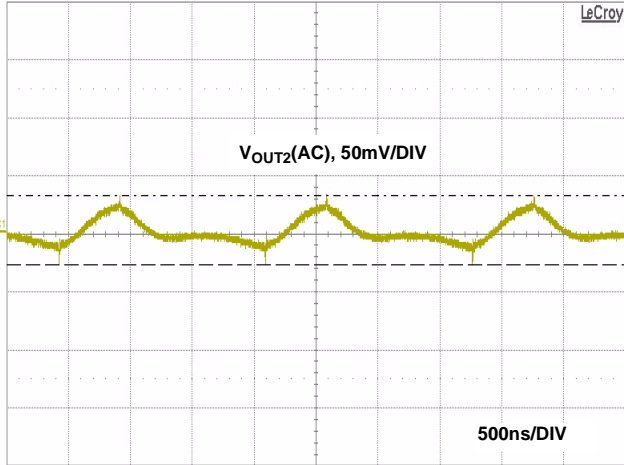

FIGURE 9. PWM2 OUTPUT RIPPLE UNDER MAX LOAD
($V_{IN} = 12V$, $I_{O1} = I_{O2} = 6A$, $I_{O3} = 4A$, FULL BANDWIDTH)

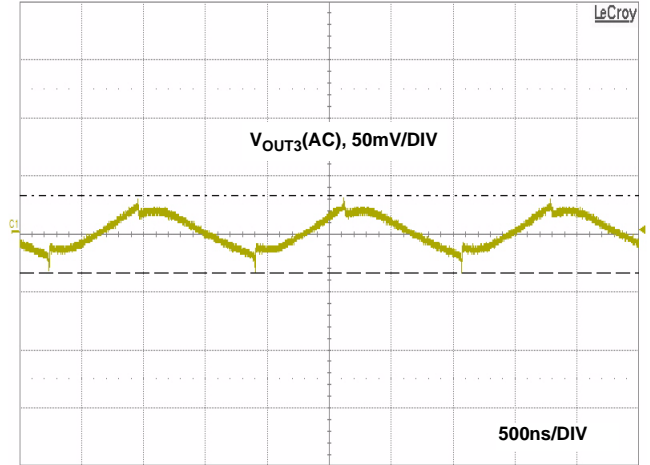

FIGURE 10. PWM3 OUTPUT RIPPLE UNDER MAX LOAD
($V_{IN} = 12V$, $I_{O1} = I_{O2} = 6A$, $I_{O3} = 4A$, FULL BANDWIDTH)

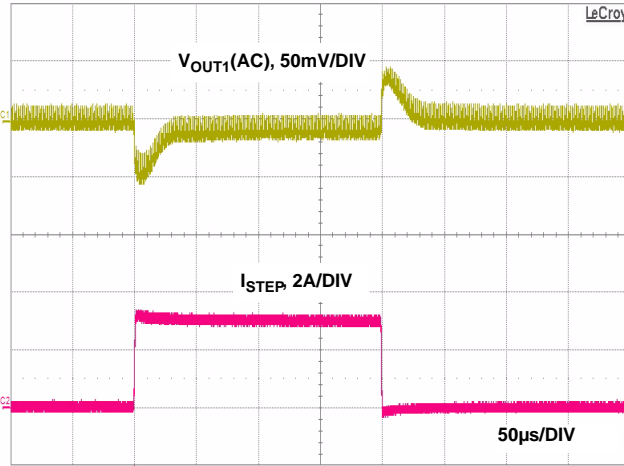

FIGURE 11. PWM1 LOAD TRANSIENT RESPONSE
(LOAD STEP FROM 1.5A TO 4.5A)

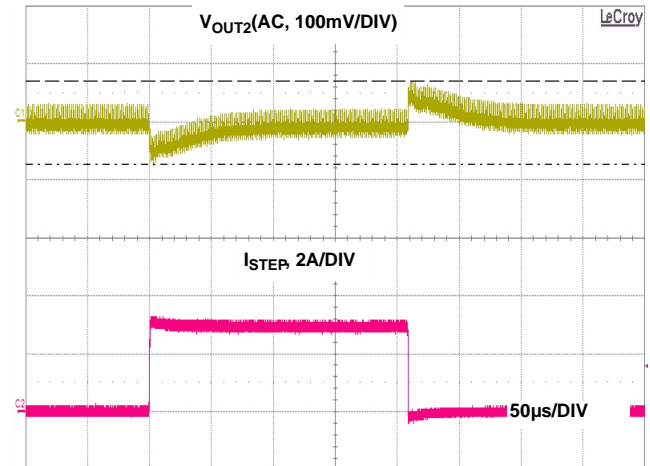

FIGURE 12. PWM2 LOAD TRANSIENT RESPONSE
(LOAD STEP FROM 1.5A TO 4.5A)

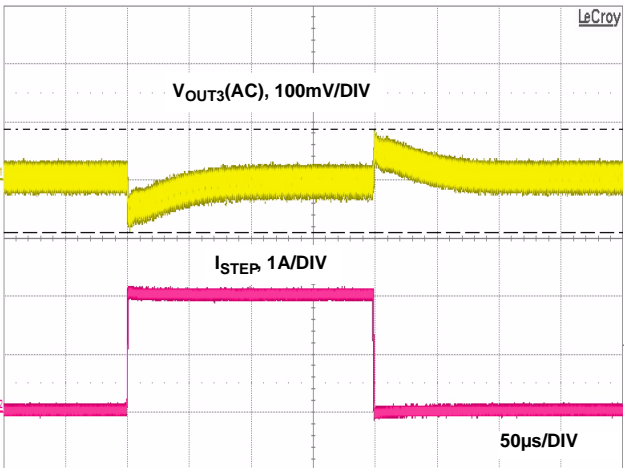

FIGURE 13. PWM3 LOAD TRANSIENT RESPONSE
(LOAD STEP FROM 1A TO 3A)

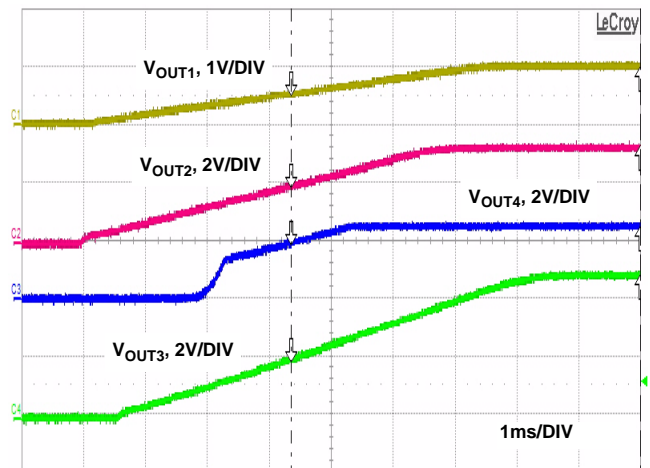
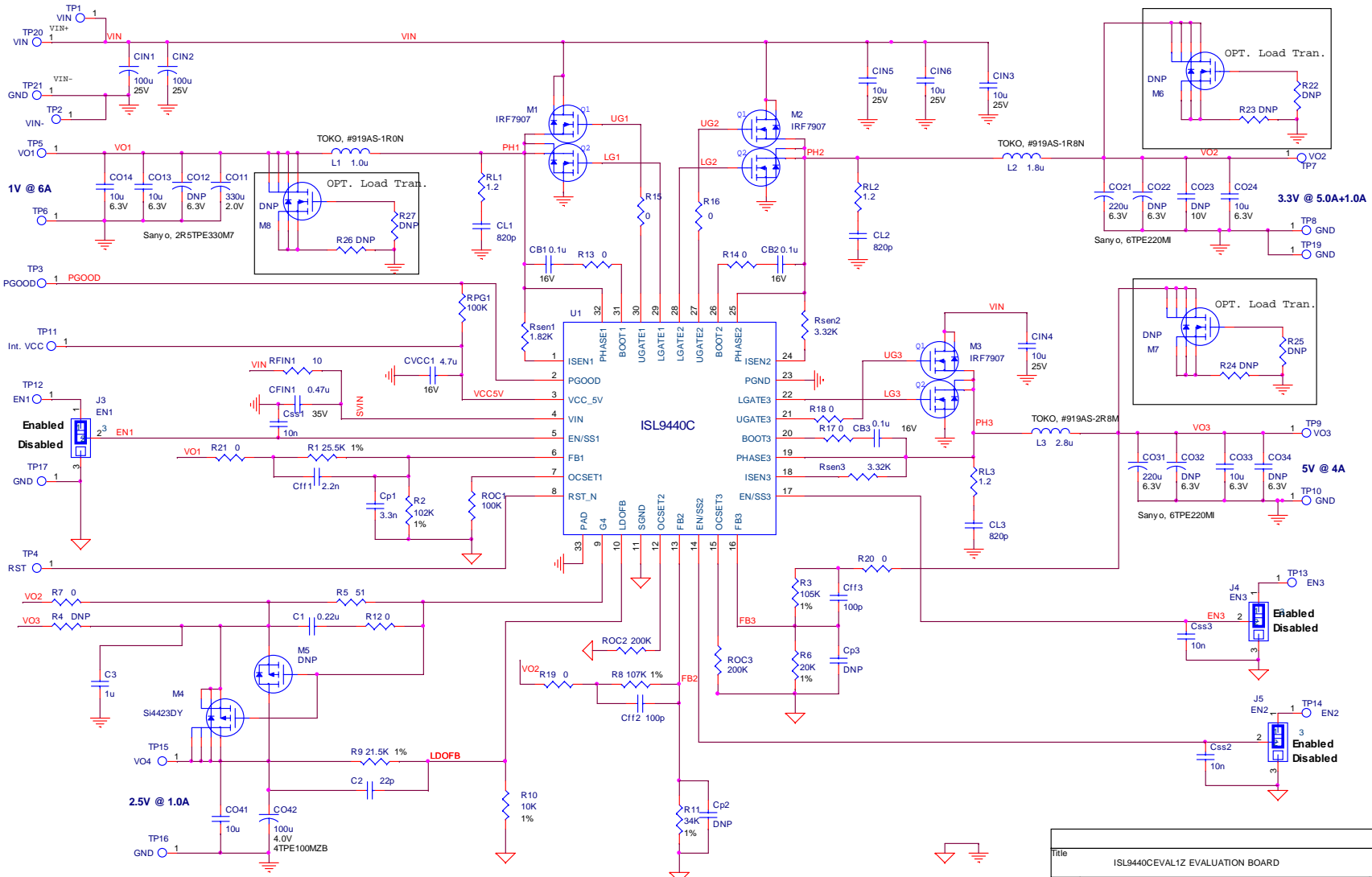

FIGURE 14. SOFT START WAVEFORMS

Schematic



Title		
ISL9440CEVAL1Z EVALUATION BOARD		
Size	Document Number	Rev
	<Doc>	B
Date:	Monday, May 11, 2009	Sheet 1 of 1

Application Note 1482

TABLE 2. BILL OF MATERIALS

ESSENTIAL COMPONENTS						
ITEM	QTY	PART REFERENCE	VALUE	DESCRIPTION	PART #	MANUFACTURER
1	3	CB1, CB2, CB3	0.1 μ F	CAP Ceramic X5R, 16V, SMD, 0603,		Generic
2	1	CFIN1	0.47 μ F	CAP Ceramic X5R, 25V, SMD, 0603,		Generic
3	2	CIN1, CIN2	100 μ F	Alum. Elec. CAP 25V		Panasonic
4	4	CIN3, CIN4, CIN5, CIN6	10 μ F	CAP Ceramic X5R, 25V, SMD, 1206,		Generic
5	3	CL1, CL2, CL3	820pF	CAP Ceramic X5R, 16V, SMD, 0603,		Generic
6	1	CO11	330 μ F	POSCAP, 2.0V, SMD, D2E	2R5TPE330M7	Sanyo
7	5	CO13, CO14, CO24, CO33, CO41	10 μ F	CAP Ceramic X5R, 6.3V, SMD, 0805		Generic
8	2	CO21, CO31	220 μ F	POSCAP, 6.3V, SMD, D2E	6TPE220MI	Sanyo
9	1	CO42	100 μ F	POSCAP, 4.0V, SMD, B	4TPE100MZB	Sanyo
10	1	CVCC1	4.7 μ F	CAP Ceramic X5R, 16V, SMD, 0805,		Generic
11	1	Cff1	2.2nF	CAP Ceramic, SMD, 0603,		Generic
12	2	Cff2, Cff3	100pF	CAP Ceramic, SMD, 0603,		Generic
13	1	Cp1	3.3nF	CAP Ceramic, SMD, 0603,		Generic
14	3	Css1, Css2, Css3	10nF	CAP Ceramic, SMD, 0603,		Generic
15	1	C1	0.22 μ F	CAP Ceramic X5R, 16V, SMD, 0603,		Generic
16	1	C2	22pF	CAP Ceramic, SMD, 0603,		Generic
17	1	C3	1 μ F	CAP Ceramic, 6.3V,SMD, 0603,		Generic
18	1	L1	1.0 μ H	SHIELDED INDUCTOR	#919AS-1R0N	TOKO
19	1	L2	1.8 μ H	SHIELDED INDUCTOR	#919AS-1R8N	TOKO
20	1	L3	2.8 μ H	SHIELDED INDUCTOR	#919AS-2R8M	TOKO
21	3	M1, M2, M3		Dual N MOSFET, 30V , SOIC8	IRF7907	International Rectifier
22	1	M4		P MOSFET, SOIC8	Si4423DY	Vishay
23	1	R _{FIN1}	10 Ω	RESISTOR, SMD, 0805, 10%		Generic
24	3	RL1, RL2, RL3	1.2 Ω	RESISTOR, SMD, 0603, 10%		Generic
25	2	RPG1, ROC1	100k Ω	RESISTOR, SMD, 0603,1%		Generic
26	2	ROC2, ROC3	200k Ω	RESISTOR, SMD, 0603,1%		Generic
27	1	R _{SEN1}	1.82k Ω	RESISTOR, SMD, 0603,1%		Generic
28	2	R _{SEN2} , R _{SEN3}	3.32k Ω	RESISTOR, SMD, 0603,1%		Generic
29	1	R1	25.5k Ω	RESISTOR, SMD, 0603,1%		Generic
30	1	R2	102k Ω	RESISTOR, SMD, 0603,1%		Generic
31	1	R3	105k Ω	RESISTOR, SMD, 0603,1%		Generic
32	1	R5	51 Ω	RESISTOR, SMD, 0603,1%		Generic
33	1	R6	20k Ω	RESISTOR, SMD, 0603,1%		Generic
34	1	R8	107k Ω	RESISTOR, SMD, 0603,1%		Generic
35	1	R9	21.5k Ω	RESISTOR, SMD, 0603,1%		Generic
36	1	R10	10k Ω	RESISTOR, SMD, 0603,1%		Generic
37	1	R11	34k Ω	RESISTOR, SMD, 0603,1%		Generic
38	1	U1	-	QUAD OUTPUT CONTROLLER	ISL9440C	Intersil

Application Note 1482

TABLE 2. BILL OF MATERIALS (Continued)

OPTIONAL COMPONENTS OR RESISTOR JUMPERS						
ITEM	QTY	REFERENCE	VALUE	DESCRIPTION	PART #	MANUFACTURER
39	10	R7, R12, R13, R14, R15, R16, R17, R18, R19, R20, R21	0	RESISTOR Jumpers, SMD, 0603, 10%		Generic
40	3	CO12, CO22, CO32	DNP			
41	2	CO23, CO34	DNP			
42	2	Cp2, Cp3	DNP			
43	1	M5	DNP	P MOSFET TO-252		
44	3	M6, M7, M8	DNP	N MOSFET		
45	4	R4, R22, R25, R27	DNP	RESISTOR, SMD, 0603		
46	3	R23, R24, R26	DNP	RESISTOR, SMD, 1206		
EVALUATION BOARD HARDWARES						
ITEM	QTY	REFERENCE	VALUE	DESCRIPTION	PART #	MANUFACTURER
47	3	J3, J4, J5	-	3 Head Jumper	68000-236HLF	Generic
48	11	TP1, TP2, TP3, TP4, TP6, TP17, TP11, TP12, TP13, TP14, TP7	-	TEST POINT	5007	Keystone
49	9	TP8, TP10, TP16, TP19, TP21, TP9, TP5, TP15, TP20	GND	TURRET	1514-2	Keystone

Intersil Corporation reserves the right to make changes in circuit design, software and/or specifications at any time without notice. Accordingly, the reader is cautioned to verify that the Application Note or Technical Brief is current before proceeding.

For information regarding Intersil Corporation and its products, see www.intersil.com

ISL9440CEVAL1Z PCB Layout

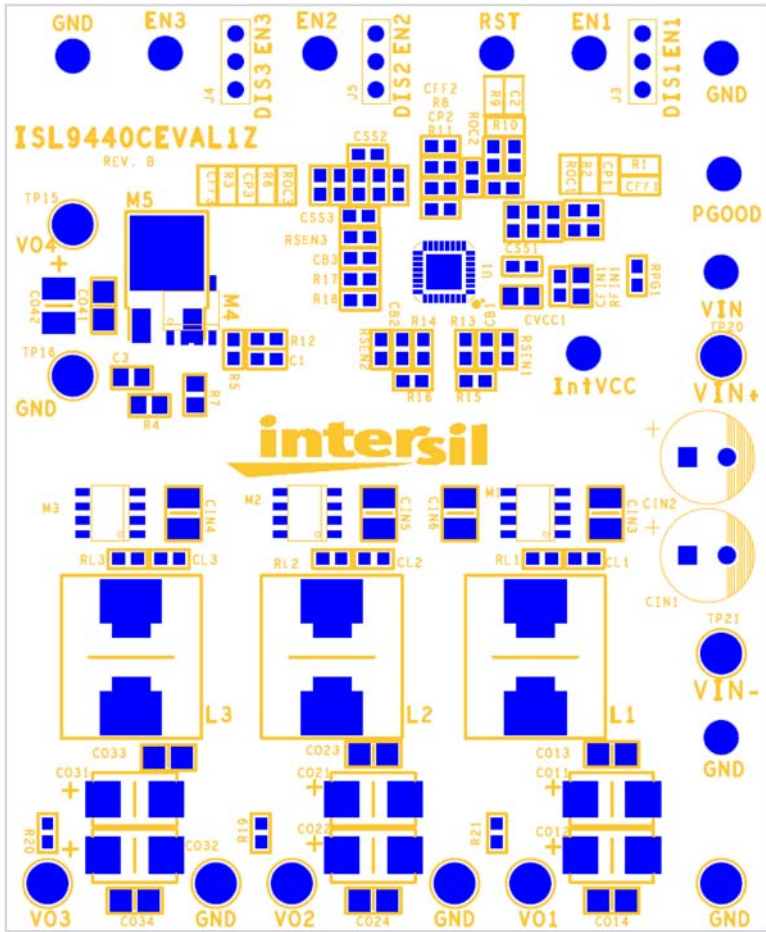

FIGURE 15. TOP COMPONENTS

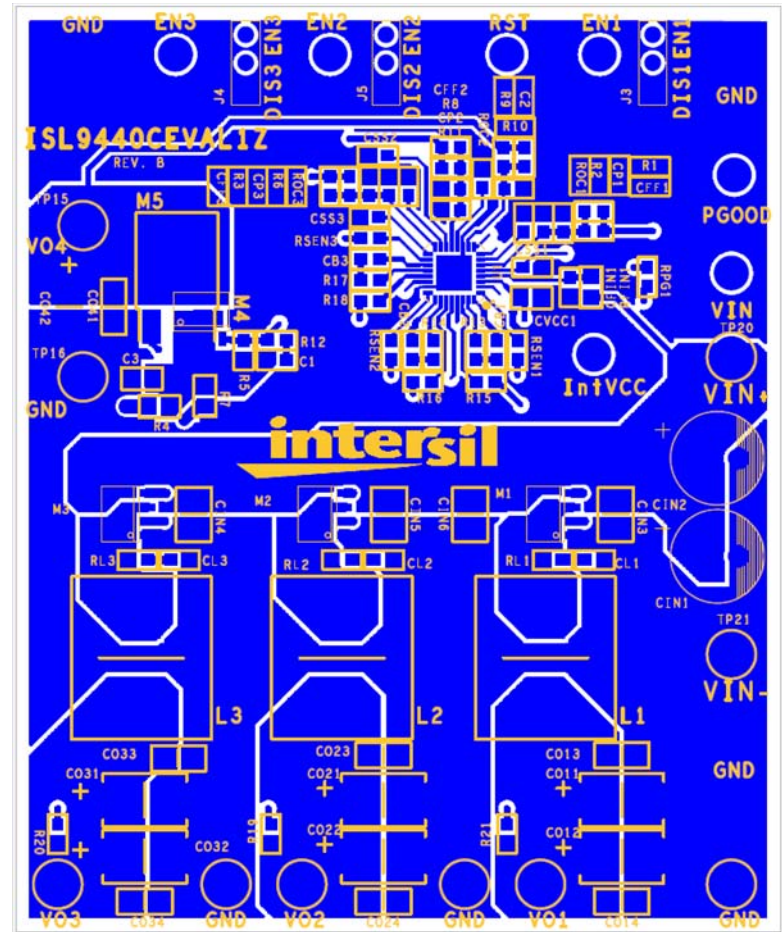

FIGURE 16. TOP LAYER

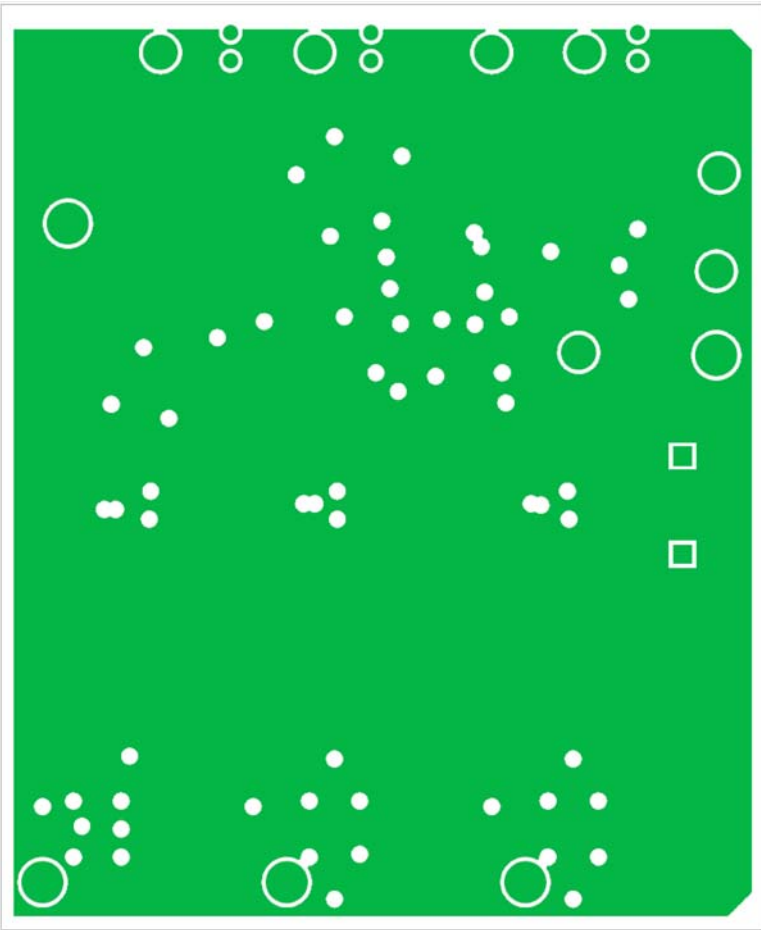

FIGURE 17. SECOND LAYER (SOLID GROUND)

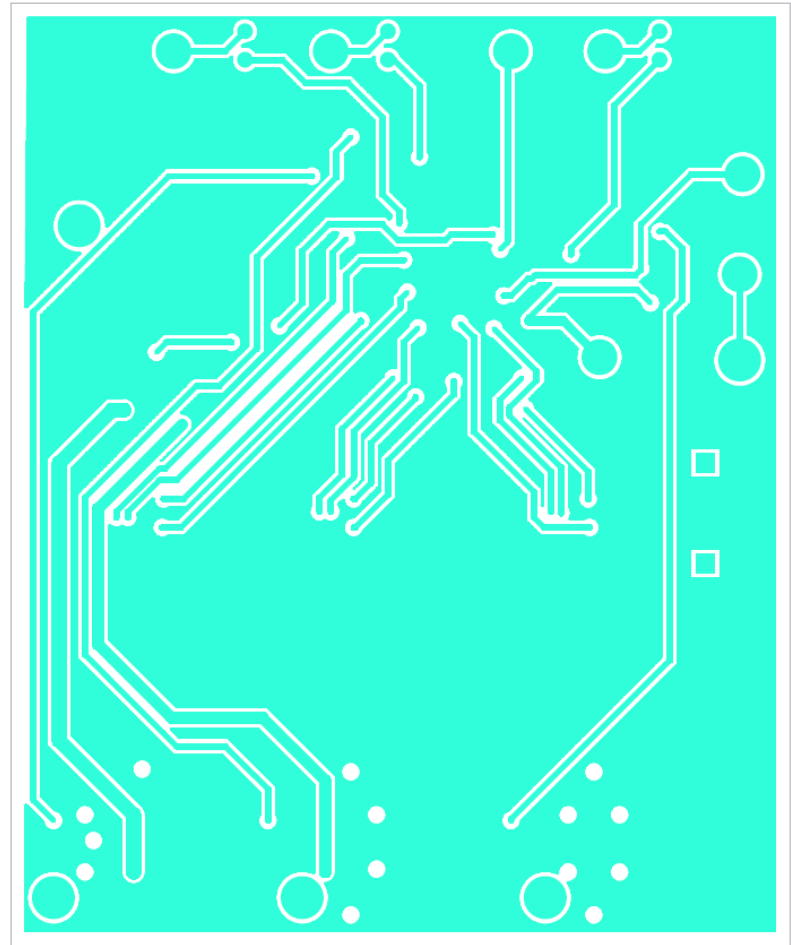

FIGURE 18. THIRD LAYER

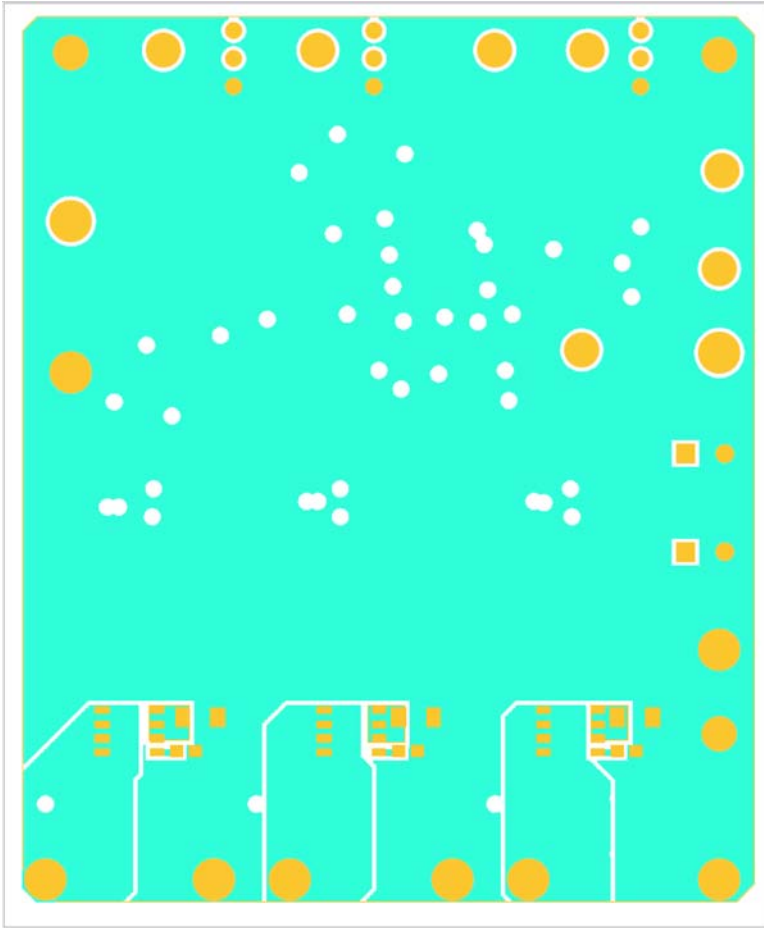

FIGURE 19. BOTTOM LAYER (MIRRORED)

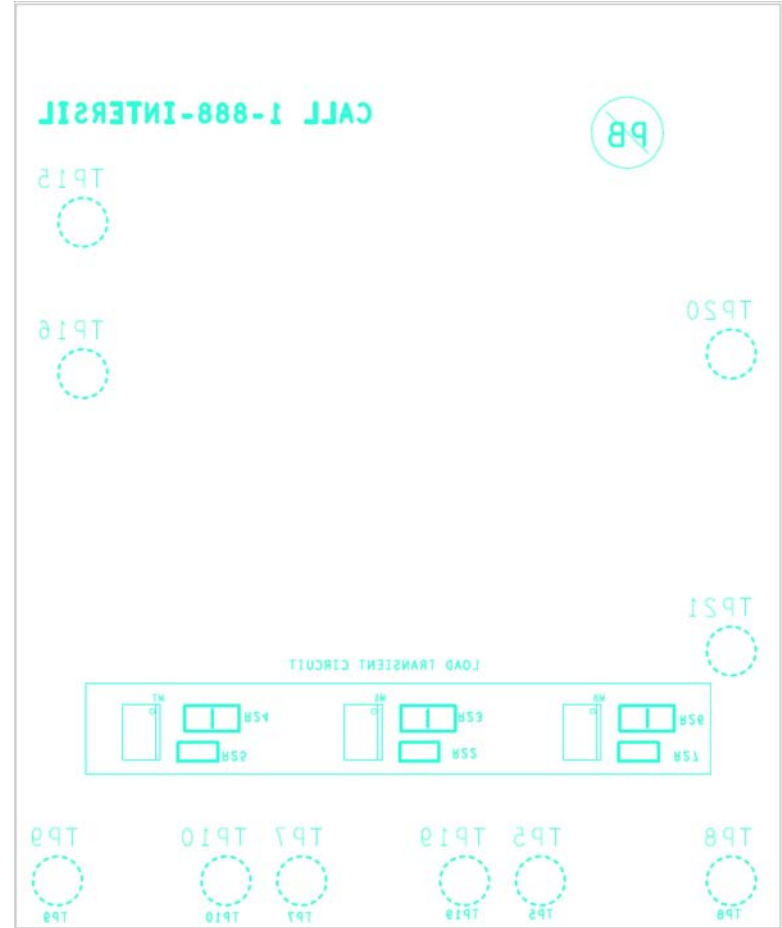

FIGURE 20. BOTTOM COMPONENTS (MIRRORED)