

CA-3083

General Purpose High Current NPN Transistor Array

FN481
Rev.7.00
December 15, 2011

The CA3083 is a versatile array of five high current (to 100mA) NPN transistors on a common monolithic substrate. In addition, two of these transistors (Q₁ and Q₂) are matched at low current (i.e., 1mA) for applications in which offset parameters are of special importance.

Independent connections for each transistor plus a separate terminal for the substrate permit maximum flexibility in circuit design.

Ordering Information

PART NUMBER	PART MARKING	TEMP. RANGE (°C)	PACKAGE	PKG. DWG. #
CA3083	CA3083	-55 to 125	16 Ld PDIP	E16.3
CA3083Z (Note)	CA3083Z	-55 to 125	16 Ld PDIP* (Pb-free)	E16.3
CA3083M96	3083	-55 to 125	16 Ld SOIC Tape and Reel	M16.15
CA3083MZ (Note)	3083MZ	-55 to 125	16 Ld SOIC (Pb-Free)	M16.15
CA3083MZ96 (Note)	3083MZ	-55 to 125	16 Ld SOIC (Pb-Free) Tape and Reel	M16.15

*Pb-free PDIPs can be used for through hole wave solder processing only. They are not intended for use in Reflow solder processing applications.

NOTE: Intersil Pb-free plus anneal products employ special Pb-free material sets; molding compounds/die attach materials and 100% matte tin plate termination finish, which are RoHS compliant and compatible with both SnPb and Pb-free soldering operations. Intersil Pb-free products are MSL classified at Pb-free peak reflow temperatures that meet or exceed the Pb-free requirements of IPC/JEDEC J STD-020.

Features

- High I_C 100mA (Max)
- Low V_{CE sat} (at 50mA). 0.7V (Max)
- Matched Pair (Q₁ and Q₂)
 - V_{IO} (V_{BE} Match). ±5mV (Max)
 - I_{IO} (at 1mA) 2.5µA (Max)
- 5 Independent Transistors Plus Separate Substrate Connection
- Pb-Free Plus Anneal Available (RoHS Compliant)

Applications

- Signal Processing and Switching Systems Operating from DC to VHF
- Lamp and Relay Driver
- Differential Amplifier
- Temperature Compensated Amplifier
- Thyristor Firing
- See Application Note AN5296 "Applications of the CA3018 Circuit Transistor Array" for Suggested Applications

Pinout

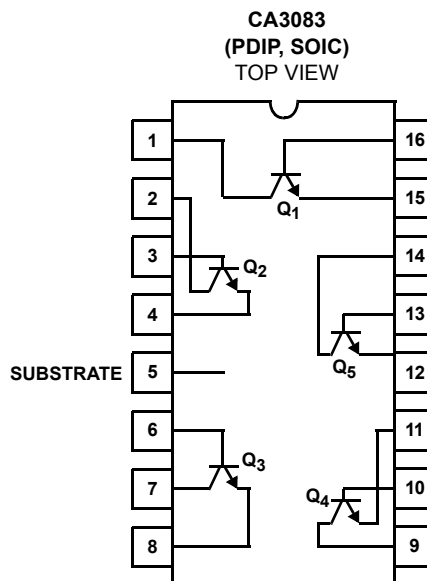

Absolute Maximum Ratings

The following ratings apply for each transistor in the device:

Collector-to-Emitter Voltage, V_{CEO}	15V
Collector-to-Base Voltage, V_{CBO}	20V
Collector-to-Substrate Voltage, V_{CIO} (Note 1)	20V
Emitter-to-Base Voltage, V_{EBO}	5V
Collector Current (I_C)	100mA
Base Current (I_B)	20mA

Thermal Information

Thermal Resistance (Typical, Note 2)	θ_{JA} (°C/W)	θ_{JC} (°C/W)
PDIP Package	135	N/A
SOIC Package	200	N/A
Maximum Power Dissipation (Any One Transistor)	500mW	
Maximum Junction Temperature (Plastic Package)	150°C	
Maximum Storage Temperature Range	-65°C to 150°C	
Maximum Lead Temperature (Soldering 10s)	300°C (SOIC - Lead Tips Only)	

Operating Conditions

Temperature Range

-55°C to 125°C

CAUTION: Stresses above those listed in "Absolute Maximum Ratings" may cause permanent damage to the device. This is a stress only rating and operation of the device at these or any other conditions above those indicated in the operational sections of this specification is not implied.

NOTES:

- The collector of each transistor of the CA3083 is isolated from the substrate by an integral diode. The substrate must be connected to a voltage which is more negative than any collector voltage in order to maintain isolation between transistors and provide normal transistor action. To avoid undesired coupling between transistors, the substrate Terminal (5) should be maintained at either DC or signal (AC) ground. A suitable bypass capacitor can be used to establish a signal ground.
- θ_{JA} is measured with the component mounted on an evaluation PC board in free air.

Electrical Specifications For Equipment Design, $T_A = 25^\circ\text{C}$

PARAMETER	SYMBOL	TEST CONDITIONS	MIN	TYP	MAX	UNITS	
FOR EACH TRANSISTOR							
Collector-to-Base Breakdown Voltage	$V_{(BR)CBO}$	$I_C = 100\mu\text{A}, I_E = 0$	20	60	-	V	
Collector-to-Emitter Breakdown Voltage	$V_{(BR)CEO}$	$I_C = 1\text{mA}, I_B = 0$	15	24	-	V	
Collector-to-Substrate Breakdown Voltage	$V_{(BR)CIO}$	$I_{CI} = 100\mu\text{A}, I_B = 0, I_E = 0$	20	60	-	V	
Emitter-to-Base Breakdown Voltage	$V_{(BR)EBO}$	$I_E = 500\mu\text{A}, I_C = 0$	5	6.9	-	V	
Collector-Cutoff-Current	I_{CEO}	$V_{CE} = 10\text{V}, I_B = 0$	-	-	10	μA	
Collector-Cutoff-Current	I_{CBO}	$V_{CB} = 10\text{V}, I_E = 0$	-	-	1	μA	
DC Forward-Current Transfer Ratio (Note 3) (Figure 1)	h_{FE}	$V_{CE} = 3\text{V}$	$I_C = 10\text{mA}$	40	76	-	
			$I_C = 50\text{mA}$	40	75	-	
Base-to-Emitter Voltage (Figure 2)	V_{BE}	$V_{CE} = 3\text{V}, I_C = 10\text{mA}$	0.65	0.74	0.85	V	
Collector-to-Emitter Saturation Voltage (Figures 3, 4)	$V_{CE\text{ SAT}}$	$I_C = 50\text{mA}, I_B = 5\text{mA}$	-	0.40	0.70	V	
Gain Bandwidth Product	f_T	$V_{CE} = 3\text{V}, I_C = 10\text{mA}$	-	450	-	MHz	
FOR TRANSISTORS Q₁ AND Q₂ (As a Differential Amplifier)							
Absolute Input Offset Voltage (Figure 6)	$ V_{IO} $	$V_{CE} = 3\text{V}, I_C = 1\text{mA}$	-	1.2	5	mV	
Absolute Input Offset Current (Figure 7)	$ I_{IO} $	$V_{CE} = 3\text{V}, I_C = 1\text{mA}$	-	0.7	2.5	μA	

NOTE:

- Actual forcing current is via the emitter for this test.

Typical Performance Curves

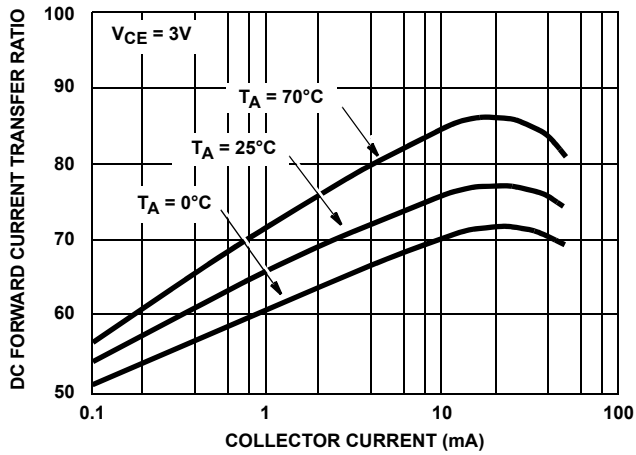

FIGURE 1. h_{FE} vs I_C

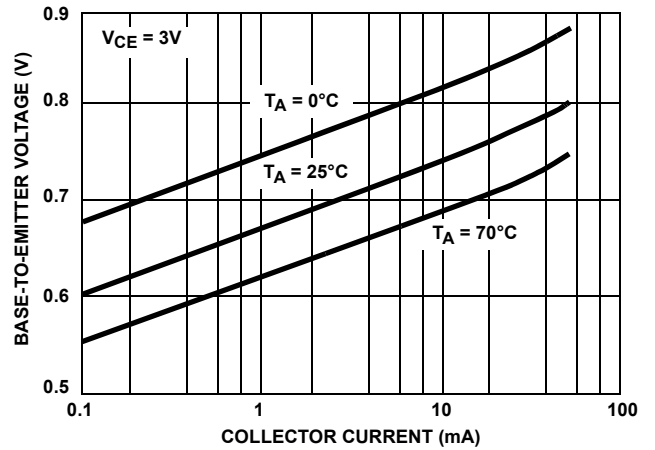

FIGURE 2. V_{BE} vs I_C

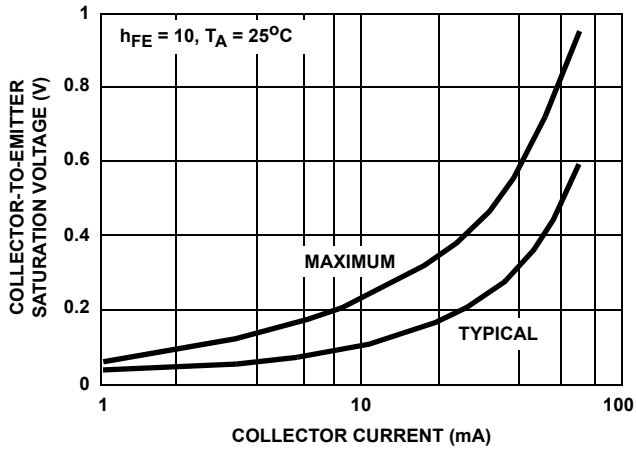

FIGURE 3. $V_{CE SAT}$ vs I_C

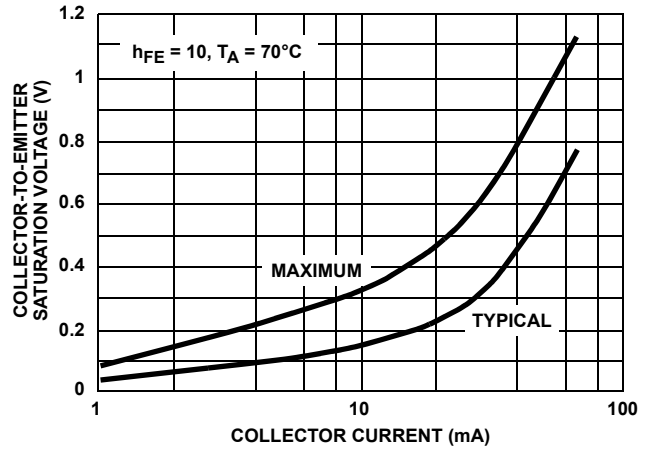

FIGURE 4. $V_{CE SAT}$ vs I_C

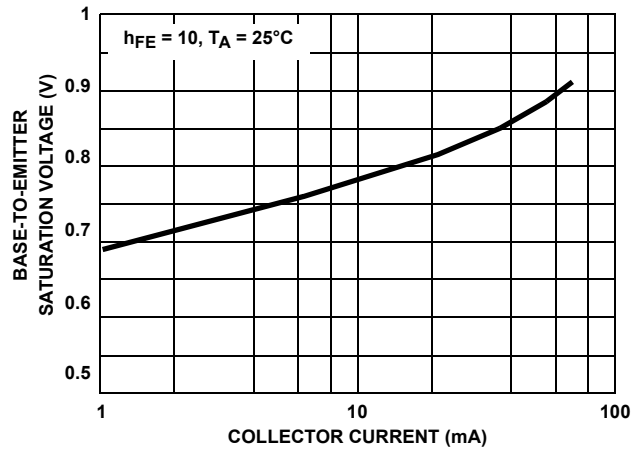

FIGURE 5. $V_{BE SAT}$ vs I_C

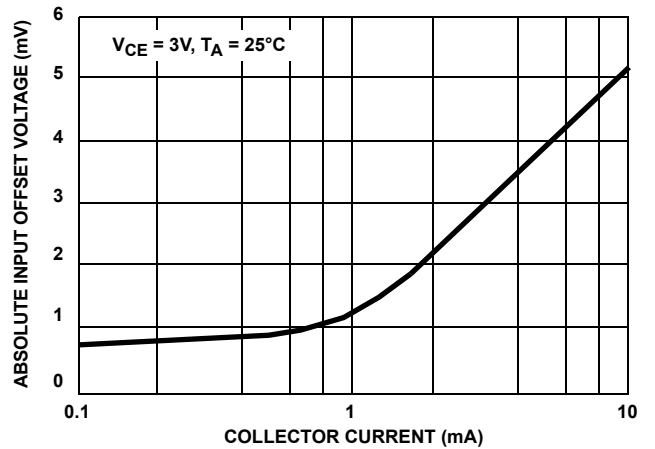

FIGURE 6. V_{IO} vs I_C (TRANSISTORS Q_1 AND Q_2 AS A DIFFERENTIAL AMPLIFIER)

Typical Performance Curves (Continued)

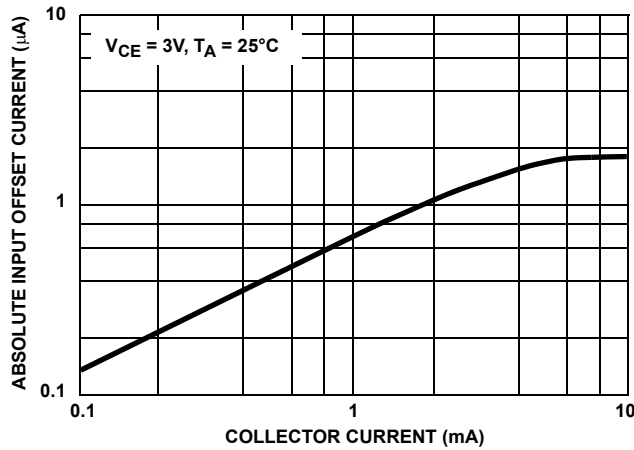

FIGURE 7. I_{IO} vs I_C (TRANSISTORS Q_1 AND Q_2 AS A DIFFERENTIAL AMPLIFIER)

© Copyright Intersil Americas LLC 1998-2011. All Rights Reserved.
 All trademarks and registered trademarks are the property of their respective owners.

For additional products, see www.intersil.com/en/products.html

Intersil products are manufactured, assembled and tested utilizing ISO9001 quality systems as noted in the quality certifications found at www.intersil.com/en/support/qualandreliability.html

Intersil products are sold by description only. Intersil may modify the circuit design and/or specifications of products at any time without notice, provided that such modification does not, in Intersil's sole judgment, affect the form, fit or function of the product. Accordingly, the reader is cautioned to verify that datasheets are current before placing orders. Information furnished by Intersil is believed to be accurate and reliable. However, no responsibility is assumed by Intersil or its subsidiaries for its use; nor for any infringements of patents or other rights of third parties which may result from its use. No license is granted by implication or otherwise under any patent or patent rights of Intersil or its subsidiaries.

For information regarding Intersil Corporation and its products, see www.intersil.com