



Parameter	Rating	Units
Blocking Voltage	60	V _P
Load Current	100	mA _{rms} / mA _{DC}
On-Resistance (max)	16	Ω
LED Current to operate	1	mA

Features

- Designed for Use in Security Systems Complying with EN50130-4
- Only 1mA of LED Current Required to Operate
- 1500V_{rms} Input/Output Isolation
- High Reliability
- Arc-Free With No Snubbing Circuits
- No EMI/RFI Generation
- Immune to Radiated EM Fields
- Halogen Free
- Tape & Reel Version Available
- Small 4-Pin SOP Package
- Flammability Rating UL 94 V-0

Applications

- Security
 - Passive Infrared Detectors (PIR)
 - Data Signalling
 - Sensor Circuitry
- Instrumentation
 - Multiplexers
 - Data Acquisition
 - Electronic Switching
 - I/O Subsystems
- Meters (Watt-Hour, Water, Gas)
- Medical Equipment—Patient/Equipment Isolation
- Aerospace
- Industrial Controls

Description

The CPC1017N is a miniature single-pole, normally-open (1-Form-A) solid state relay in a 4-pin SOP package that employs optically coupled MOSFET technology to provide 1500V_{rms} of input to output isolation. The super-efficient MOSFET switches and photovoltaic die use IXYS Integrated Circuits Division's patented OptoMOS architecture while the optically coupled output is controlled by a highly efficient infrared LED.

IXYS Integrated Circuits Division's state of the art double-molded vertical construction packaging enables CPC1017N to be one of the world's smallest relays. It offers board space savings of at least 20% over the competitor's larger 4-pin SOP relay.

Approvals

- UL Recognized Component: File E76270
- CSA Certified Component: Certificate 1172007
- EN/IEC 60950-1 Certified Component: Certificate B 13 12 82667 003

Ordering Information

Part #	Description
CPC1017N	4-Pin SOP (100/tube)
CPC1017NTR	4-Pin SOP (2000/reel)

Pin Configuration

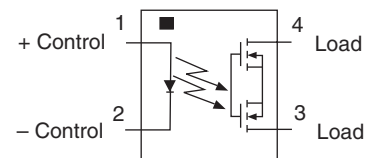

Switching Characteristics of Normally-Open Devices

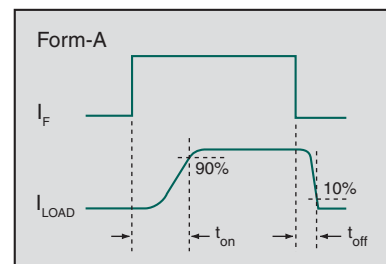

Absolute Maximum Ratings @ 25°C

Parameter	Ratings	Units
Blocking Voltage	60	V _P
Reverse Input Voltage	5	V
Input Control Current	50	mA
Peak (10ms)	1	A
Input Power Dissipation	70	mW
Total Power Dissipation ¹	400	mW
Isolation Voltage, Input to Output	1500	V _{rms}
Operational Temperature	-40 to +85	°C
Storage Temperature	-40 to +125	°C

¹ Derate linearly 3.33 mW / °C

Absolute Maximum Ratings are stress ratings. Stresses in excess of these ratings can cause permanent damage to the device. Functional operation of the device at conditions beyond those indicated in the operational sections of this data sheet is not implied.

Typical values are characteristic of the device at +25°C, and are the result of engineering evaluations. They are provided for information purposes only, and are not part of the manufacturing testing requirements.

Electrical Characteristics @ 25°C

Parameter	Conditions	Symbol	Min	Typ	Max	Units
Output Characteristics						
Load Current						
Continuous ¹	I _F =2mA	I _L	-	-	100	mA _{rms} / mA _{DC}
Peak	t=10ms	I _{LPK}	-	-	±350	mA _P
On-Resistance ²	I _L =100mA	R _{ON}	-	-	16	Ω
Off-State Leakage Current	V _L =60V _P	I _{LEAK}	-	-	1	μA
Switching Speeds						
Turn-On	I _F =5mA, V _L =10V	t _{on}	-	-	10	ms
Turn-Off		t _{off}	-	-	10	ms
Output Capacitance	I _F =0mA, V _L =50V, f=1MHz	C _{OUT}	-	5	-	pF
Input Characteristics						
Input Control Current to Activate ³	I _L =100mA	I _F	-	0.4	1	mA
Input Control Current to Deactivate	-	I _F	0.3	-	-	mA
Input Voltage Drop	I _F =5mA	V _F	0.9	1.2	1.5	V
Reverse Input Current	V _R =5V	I _R	-	-	10	μA
Common Characteristics						
Capacitance, Input to Output	V _{IO} =0V, f=1MHz	C _{IO}	-	1	-	pF

¹ Load current derates linearly from 100mA @ 25°C to 80mA @ 80°C.

² Measurement taken within 1 second of on-time.

³ For applications requiring high temperature operation (greater than 60°C) a minimum LED drive current of 3mA is recommended.

PERFORMANCE DATA*

Typical LED Forward Voltage Drop
(N=50, $I_F=5\text{mA}$)

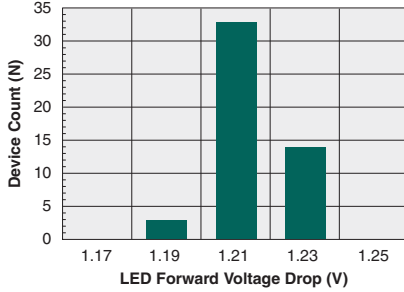

Typical Turn-On Time
(N=50, $I_F=5\text{mA}$, $I_L=100\text{mA}$)

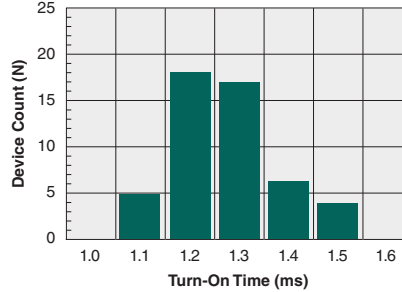

Typical Turn-Off Time
(N=50, $I_F=5\text{mA}$, $I_L=100\text{mA}$)

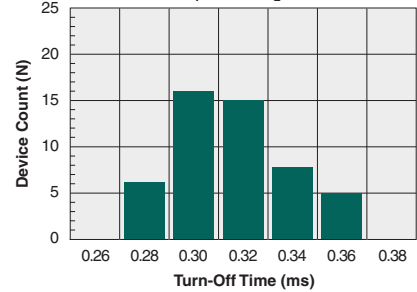

Typical I_F for Switch Operation
(N=50, $I_L=100\text{mA}$)

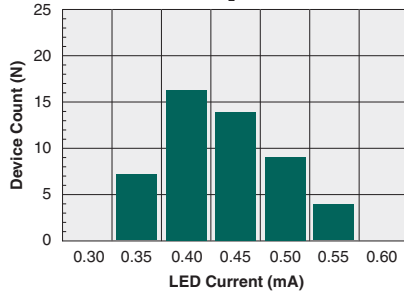

Typical I_F for Switch Dropout
(N=50, $I_L=100\text{mA}$)

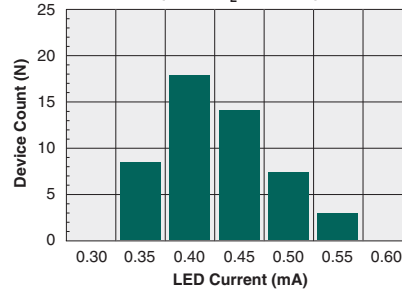

Typical On-Resistance Distribution
(N=50, $I_L=100\text{mA}$)

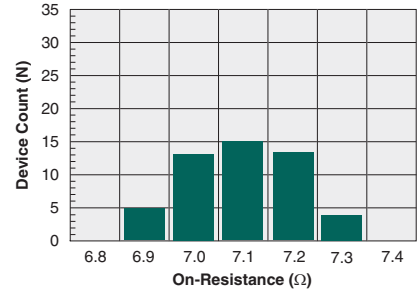

Typical Blocking Voltage Distribution
(N=50)

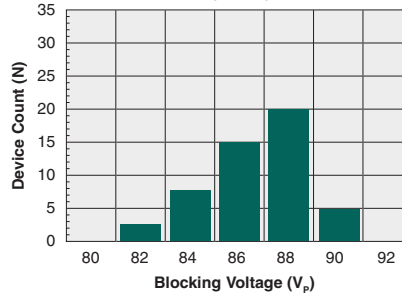

Typical LED Forward Voltage Drop vs. Temperature

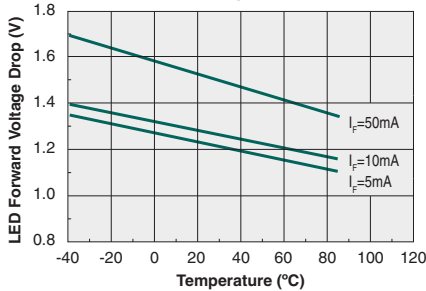

Typical Turn-On Time vs. LED Forward Current
($I_L=100\text{mA}$)

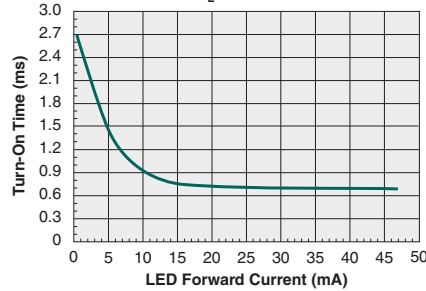

Typical Turn-Off Time vs. LED Forward Current
($I_L=100\text{mA}$)

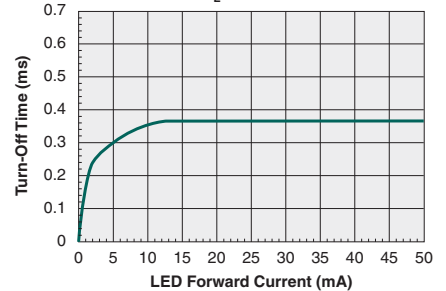

*Unless otherwise noted, data presented in these graphs is typical of device operation at 25°C.
For guaranteed parameters not indicated in the written specifications, please contact our application department.

PERFORMANCE DATA*

Typical I_F for Switch Operation vs. Temperature ($I_L=80mA$)

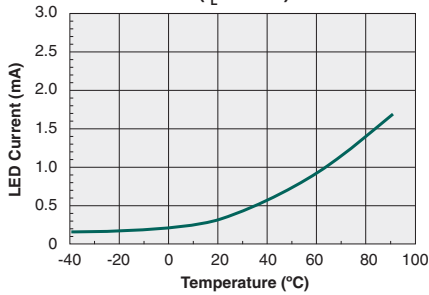

Typical Turn-On Time vs. Temperature ($I_L=50mA$)

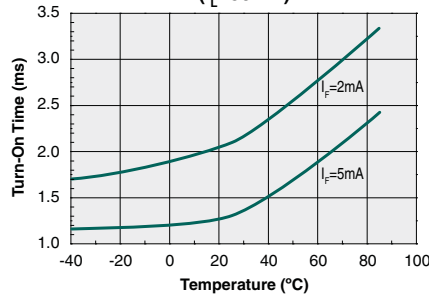

Typical Turn-Off Time vs. Temperature ($I_L=50mA$)

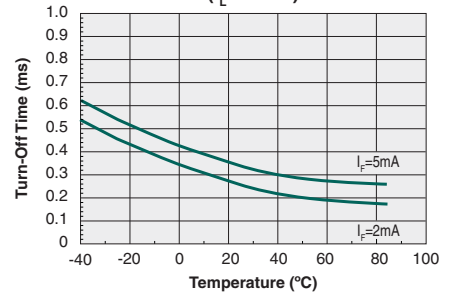

Typical On-Resistance vs. Temperature ($I_L=Max\ Rated\ @\ Temperature$)

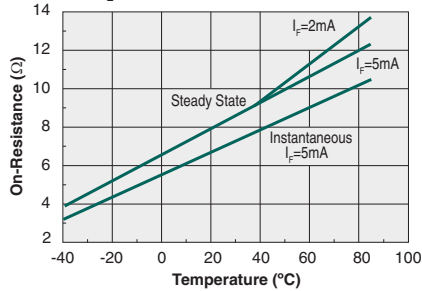

Typical Load Current vs. Load Voltage ($I_F=5mA$)

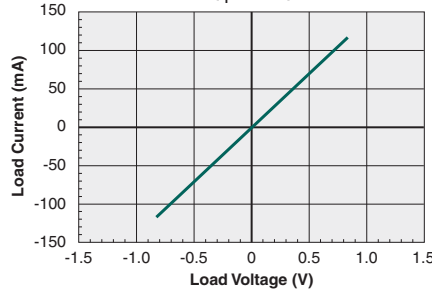

Typical Maximum Load Current vs. Temperature

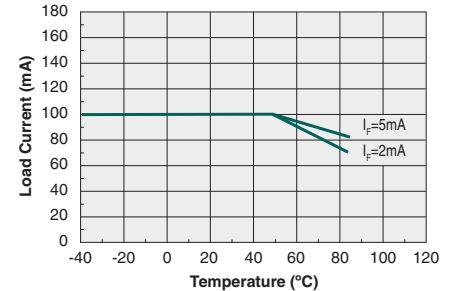

Typical Blocking Voltage vs. Temperature

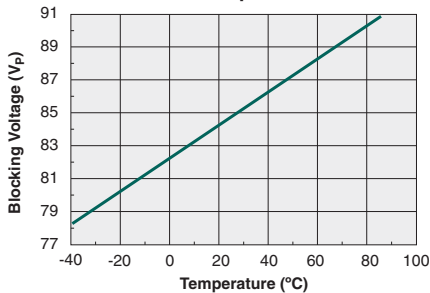

Typical Leakage vs. Temperature Measured Across Pins 3&4 ($V_L=60V$)

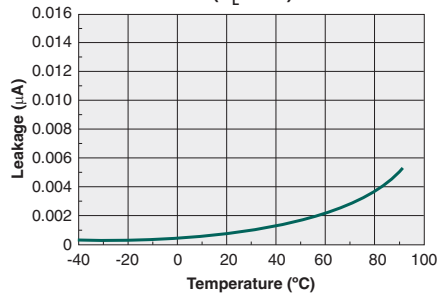

Output Capacitance vs. Load Voltage ($I_F=0mA, f=1MHz$)

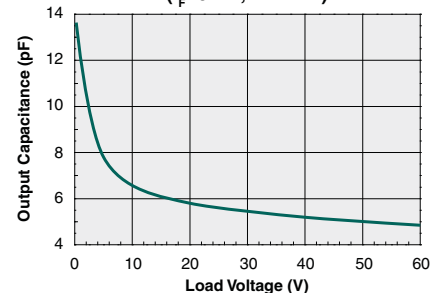

Energy Rating Curve

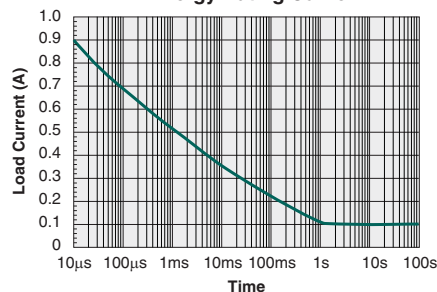

*Unless otherwise noted, data presented in these graphs is typical of device operation at 25°C. For guaranteed parameters not indicated in the written specifications, please contact our application department.

Manufacturing Information

Moisture Sensitivity



All plastic encapsulated semiconductor packages are susceptible to moisture ingress. IXYS Integrated Circuits Division classifies its plastic encapsulated devices for moisture sensitivity according to the latest version of the joint industry standard, **IPC/JEDEC J-STD-020**, in force at the time of product evaluation. We test all of our products to the maximum conditions set forth in the standard, and guarantee proper operation of our devices when handled according to the limitations and information in that standard as well as to any limitations set forth in the information or standards referenced below.

Failure to adhere to the warnings or limitations as established by the listed specifications could result in reduced product performance, reduction of operable life, and/or reduction of overall reliability.

This product carries a Moisture Sensitivity Level (MSL) classification as shown below, and should be handled according to the requirements of the latest version of the joint industry standard **IPC/JEDEC J-STD-033**.

Device	Moisture Sensitivity Level (MSL) Classification
CPC1017N	MSL 3

ESD Sensitivity



This product is **ESD Sensitive**, and should be handled according to the industry standard **JESD-625**.

Soldering Profile

Provided in the table below is the Classification Temperature (T_C) of this product and the maximum dwell time the body temperature of this device may be ($T_C - 5$)°C or greater. The classification temperature sets the Maximum Body Temperature allowed for this device during lead-free reflow processes. For through-hole devices, and any other processes, the guidelines of **J-STD-020** must be observed.

Device	Classification Temperature (T_C)	Dwell Time (t_p)	Max Reflow Cycles
CPC1017N	260°C	30 seconds	3

Board Wash

IXYS Integrated Circuits Division recommends the use of no-clean flux formulations. Board washing to reduce or remove flux residue following the solder reflow process is acceptable provided proper precautions are taken to prevent damage to the device. These precautions include, but are not limited to: using a low pressure wash and providing a follow up bake cycle sufficient to remove any moisture trapped within the device due to the washing process. Due to the variability of the wash parameters used to clean the board, determination of the bake temperature and duration necessary to remove the moisture trapped within the package is the responsibility of the user (assembler). Cleaning or drying methods that employ ultrasonic energy may damage the device and should not be used. Additionally, the device must not be exposed to flux or solvents that are Chlorine- or Fluorine-based.



MECHANICAL DIMENSIONS

CPC1017N

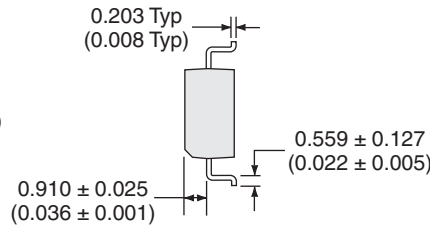
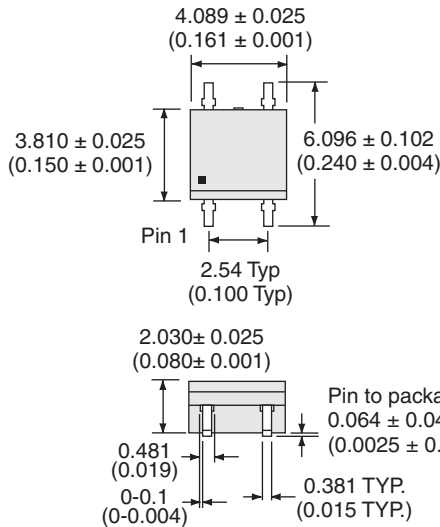

Recommended PCB Land Pattern

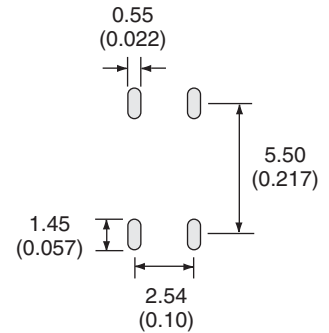

CPC1017N device weight = 0.076 grams

Dimensions
mm
(inches)

CPC1017NTR Tape & Reel

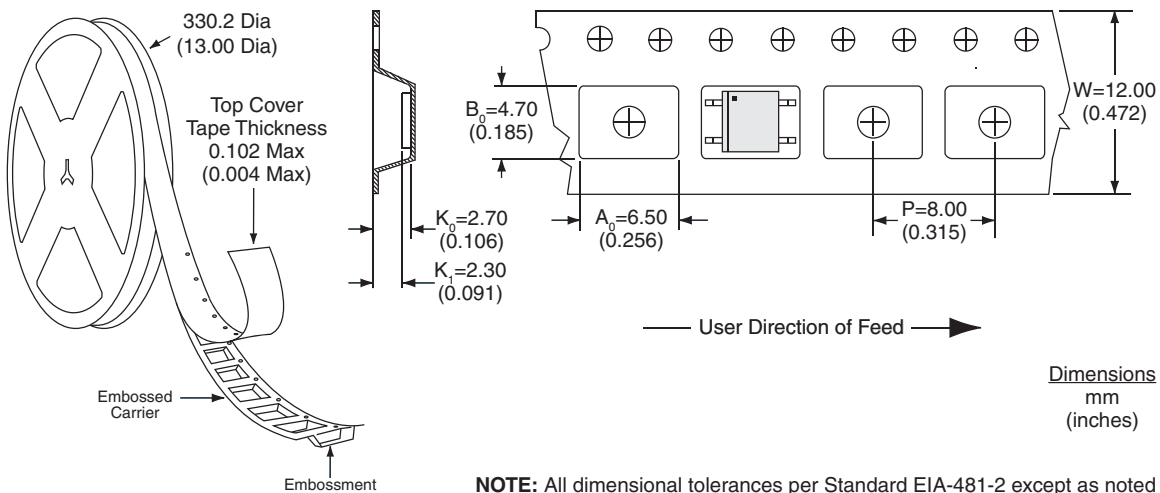

Dimensions
mm
(inches)

NOTE: All dimensional tolerances per Standard EIA-481-2 except as noted

For additional information please visit our website at: www.ixysic.com

IXYS Integrated Circuits Division makes no representations or warranties with respect to the accuracy or completeness of the contents of this publication and reserves the right to make changes to specifications and product descriptions at any time without notice. Neither circuit patent licenses nor indemnity are expressed or implied. Except as set forth in IXYS Integrated Circuits Division's Standard Terms and Conditions of Sale, IXYS Integrated Circuits Division assumes no liability whatsoever, and disclaims any express or implied warranty, relating to its products including, but not limited to, the implied warranty of merchantability, fitness for a particular purpose, or infringement of any intellectual property right.

The products described in this document are not designed, intended, authorized or warranted for use as components in systems intended for surgical implant into the body, or in other applications intended to support or sustain life, or where malfunction of IXYS Integrated Circuits Division's product may result in direct physical harm, injury, or death to a person or severe property or environmental damage. IXYS Integrated Circuits Division reserves the right to discontinue or make changes to its products at any time without notice.