

**Product number FA10887_TINA-RS**

Family	Tina	FWHM	10 degrees
Type	Assembly	Efficiency	93 %
LED	XP-E	cd/lm	18.300
Color	White	Gerber File	Available
Diameter	16.1 mm		
Height	9.7 mm		
Style	Round		
Optic Material	PMMA		
Holder Material	-		
Fastening	["tape"]		
Status	Production ready		

**Product number FA10644_TINA-D**

Family	Tina	FWHM	14 degrees
Type	Assembly	Efficiency	93 %
LED	XP-E	cd/lm	9.580
Color	White	Gerber File	Available
Diameter	16.1 mm		
Height	9.7 mm		
Style	Round		
Optic Material	PMMA		
Holder Material	-		
Fastening	["tape"]		
Status	Production ready		

**Product number FA10645_TINA-M**

Family	Tina	FWHM	30 degrees
Type	Assembly	Efficiency	91 %
LED	XP-E	cd/lm	2.440
Color	White	Gerber File	Available
Diameter	16.1 mm		
Height	9.7 mm		
Style	Round		
Optic Material	PMMA		
Holder Material	-		
Fastening	["tape"]		
Status	Production ready		

**Product number FA11200_TINA-O**

Family	Tina	FWHM	33+15 degrees
Type	Assembly	Efficiency	93 %
LED	XP-E	cd/lm	3.750
Color	White	Gerber File	Available
Diameter	16.1 mm		
Height	9.7 mm		
Style	Round		
Optic Material	PMMA		
Holder Material	-		
Fastening	["tape"]		
Status	Production ready		

PRODUCT DATASHEET

Tina series

last update 6/11/2015

**Product number FA10838_TINA-W**

Family	Tina	FWHM	39 degrees
Type	Assembly	Efficiency	92 %
LED	XP-E	cd/lm	1.730
Color	White	Gerber File	Available
Diameter	16.1 mm		
Height	9.7 mm		
Style	Round		
Optic Material	PMMA		
Holder Material	-		
Fastening	["tape"]		
Status	Production ready		

Product number FA11019_TINA-WW

Family	Tina	FWHM	58 degrees
Type	Assembly	Efficiency	93 %
LED	XP-E	cd/lm	0.800
Color	White	Gerber File	Available
Diameter	16.1 mm		
Height	9.7 mm		
Style	Round		
Optic Material	PMMA		
Holder Material	-		
Fastening	["tape"]		
Status	Production ready		

NOTE: The typical divergence will be changed by different color, chip size and chip position tolerance. The typical total divergence is the full angle measured where the luminous intensity is half of the peak value.



PRODUCT DATASHEET

Tina series

last update 6/11/2015

GENERAL INFORMATION

- Product series especially designed & optimized for XP-E series of LEDs.
- Special care taken to make light distribution as uniform as possible.
- Lens material optical grade PMMA with high UV and temperature resistance. Allows use of high current and temperature conditions.

Please find more information about used material from below:

http://ledil.fi/sites/default/files/Documents/Technical/Material/PMMA%20N%20UL94_Yellow%20Card.pdf

<http://ledil.fi/sites/default/files/Documents/Technical/Material/PMMA%20N%20PLEXIGLAS-Datasheet.pdf>

Relative intensity of FA11019_Tina-WW-WHT (XP-G)

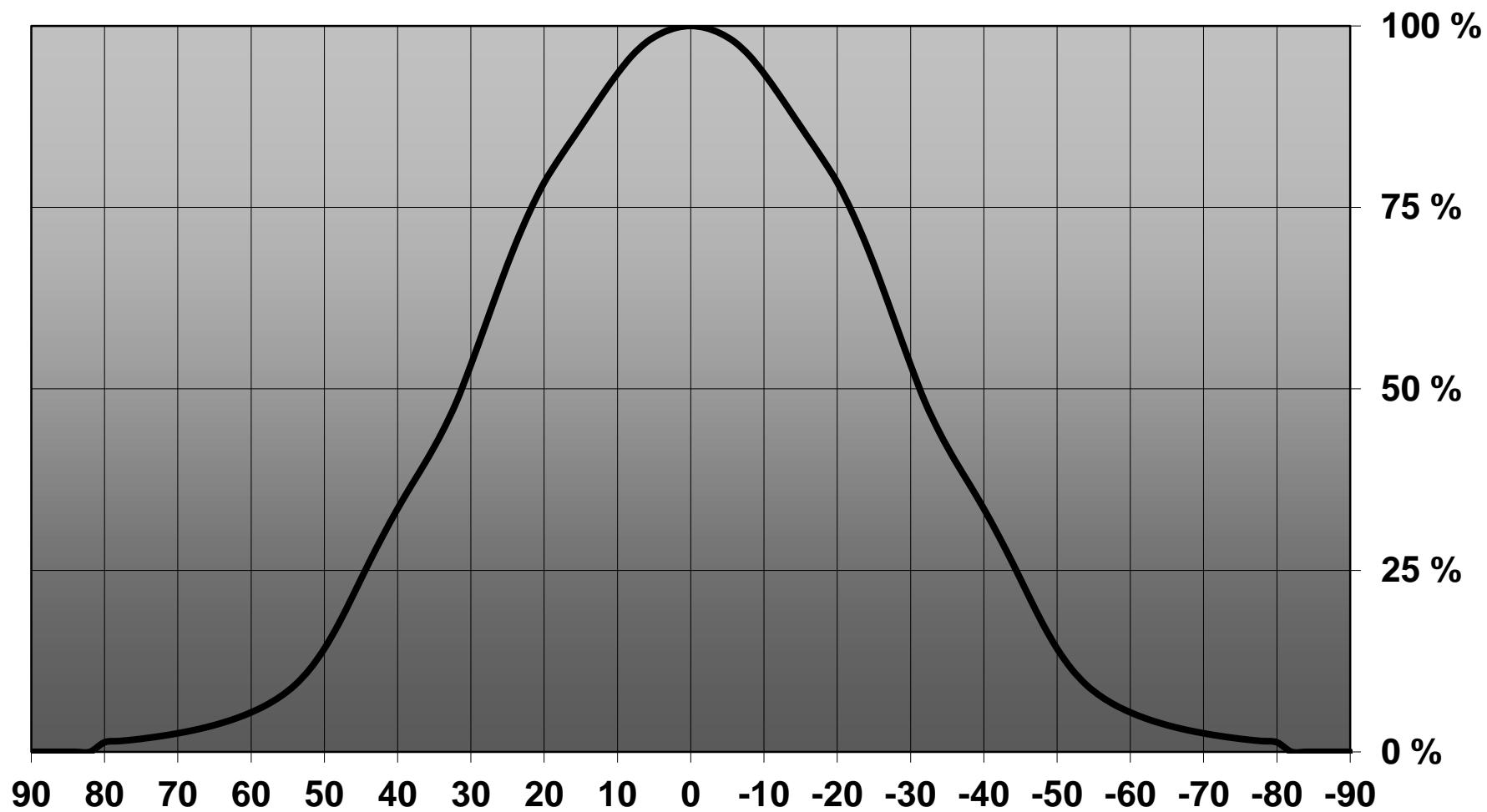

D

C

B

A

4

4

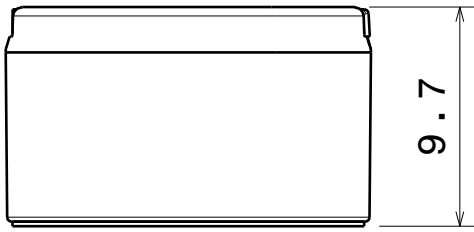

Front view

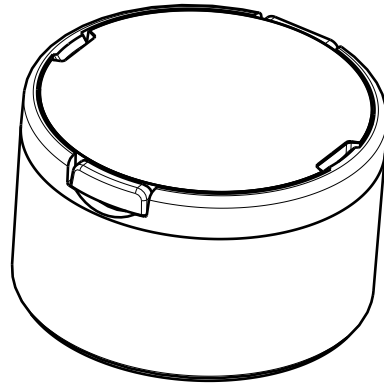

Isometric view

3

3

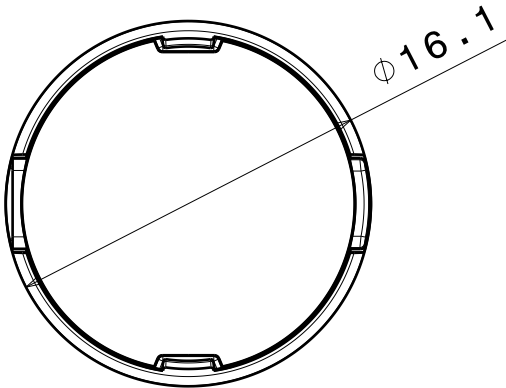

Top view

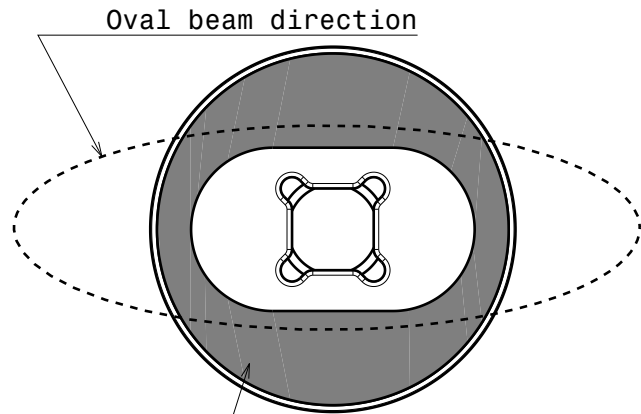

Bottom view

2

2

INDEX	PART NO	DESCRIPTION	MATERIAL	COLOUR
1	-	Tina lens	PMMA	
2	-	Tina holder	PC	white

Tolerances if not otherwise shown
 According to DIN ISO 2768-1
 Linear measures:
 Up to 30mm class M, otherwise class C.
 According to DIN ISO 2768-2
 Form and position: class L



Ledil Oy
 Salorankatu 10
 FIN 24240 SALO
 Finland

THIRD ANGLE PROJECTION:

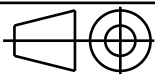

DRAWING TITLE

Tina serie datasheet

This drawing is the property
 of LEDiL Oy. It may not be
 reproduced, copied or
 communicated without a written
 agreement with LEDiL Oy.

SIZE PART NUMBER

A4

-

SCALE 1:1 WEIGHT

SHEET 1/1

D

A

1

1

Ledil Oy FA10644_Tina-XP-D FA10644_Tina-XP-D / LDC (Linear)

Luminaire: Ledil Oy FA10644_Tina-XP-D FA10644_Tina-XP-D
Lamps: 1 x Cree XP-E

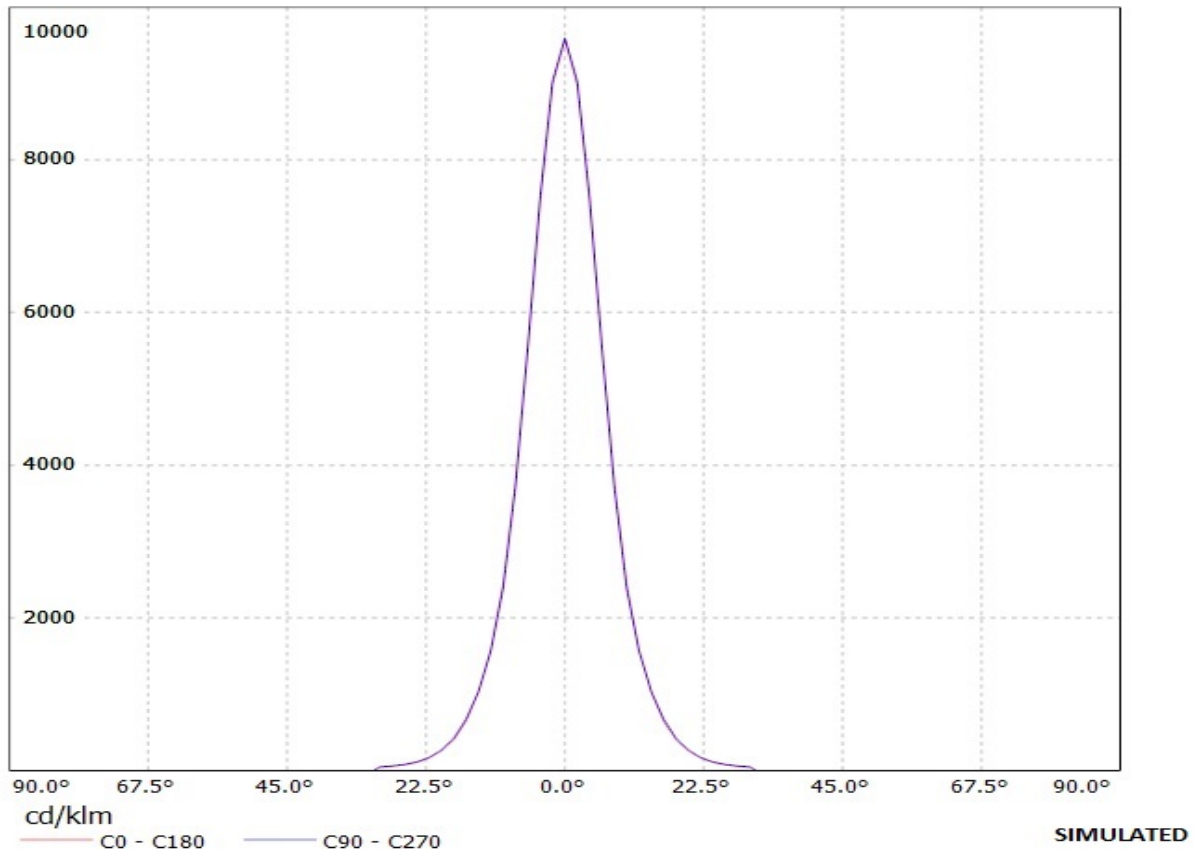

Ledil Oy F10581_Tina-XP-M F10581_Tina-XP-M / LDC (Linear)

Luminaire: Ledil Oy F10581_Tina-XP-M F10581_Tina-XP-M
Lamps: 1 x Cree XP-E

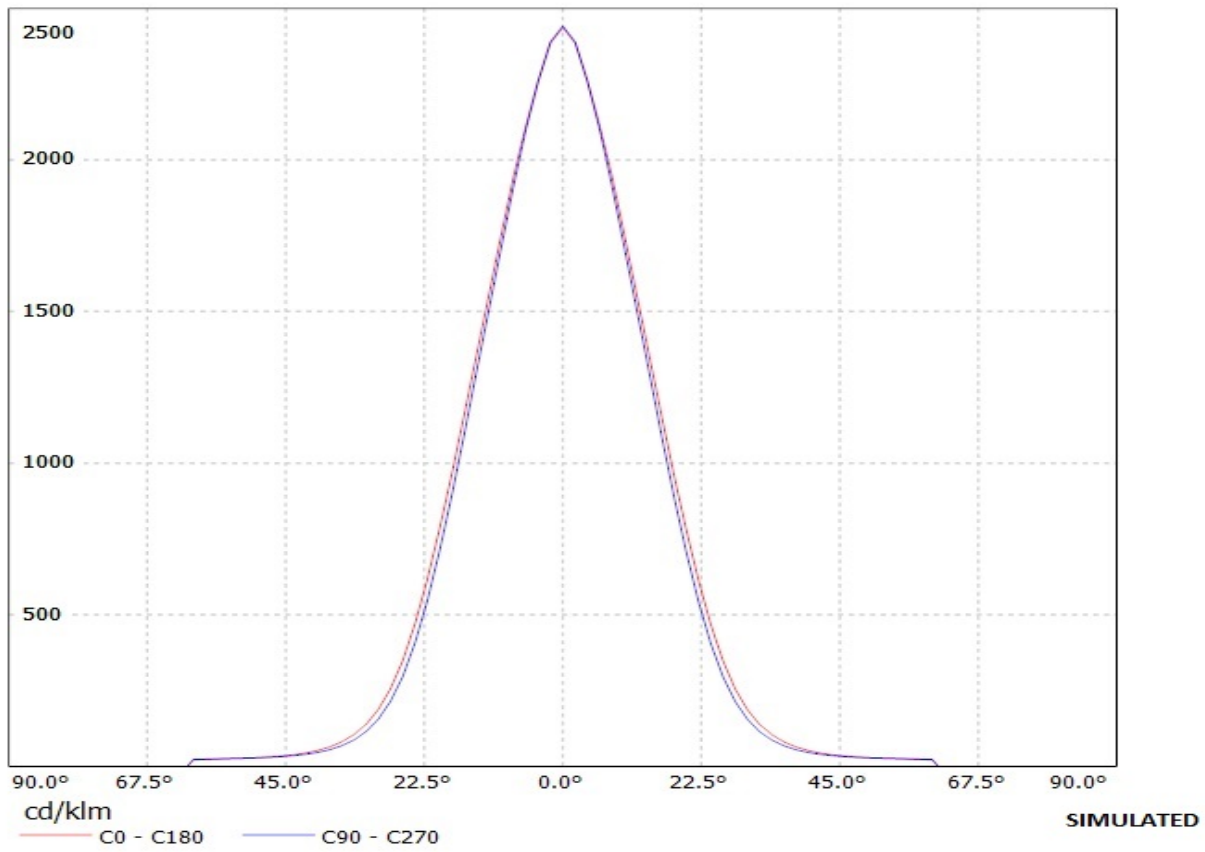

FA11200_Tina-XP-OLedil Oy FA11200_Tina-XP-O FA11200_Tina-XP-O / LDC (Linear)

Luminaire: FA11200_Tina-XP-OLedil Oy FA11200_Tina-XP-O FA11200_Tina-XP-O
Lamps: 1 x Cree XP-E (White)

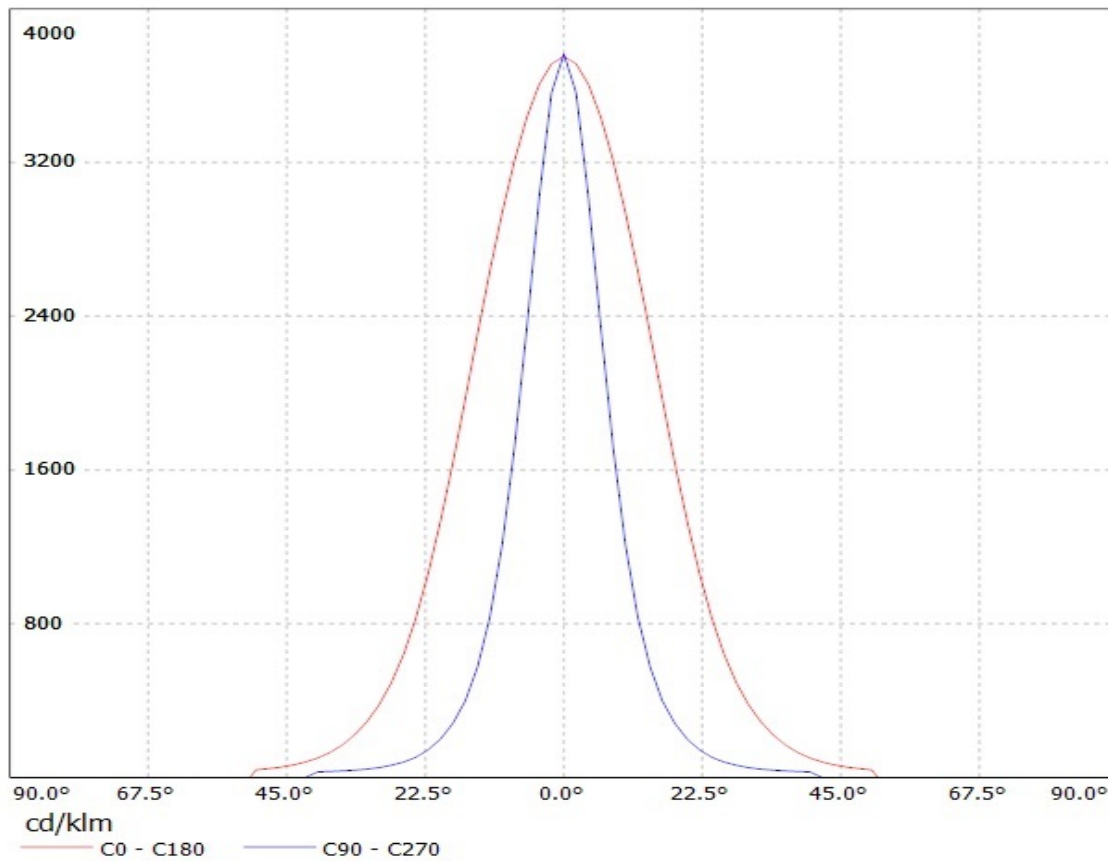

SIMULATED

Ledil Oy FA10644_Tina-XP-D FA10644_Tina-XP-D / LDC (Polar)

Luminaire: Ledil Oy FA10644_Tina-XP-D FA10644_Tina-XP-D

Lamps: 1 x Cree XP-E

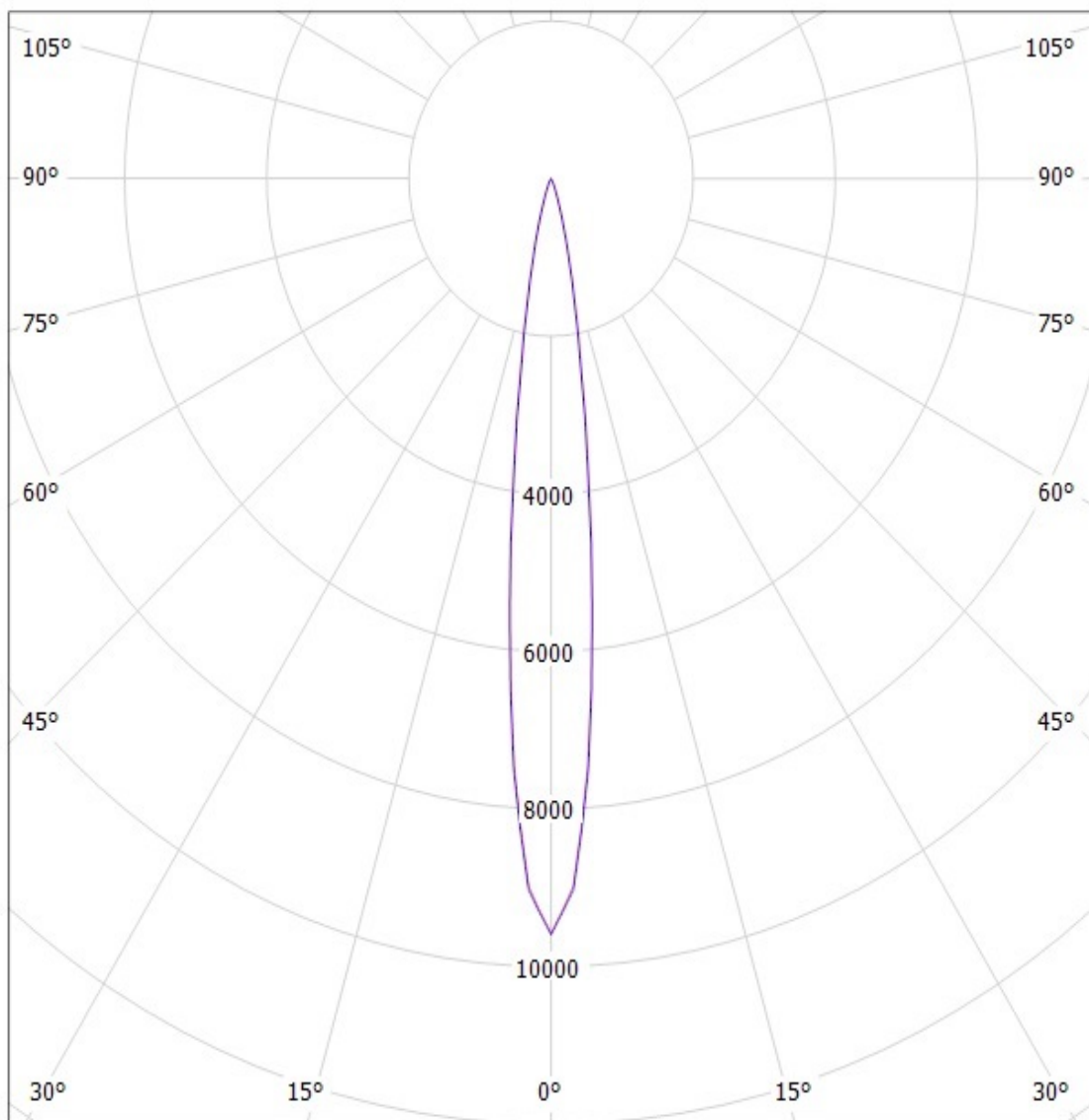

cd/klm

SIMULATED

— C0 - C180

— C90 - C270

Ledil Oy F10581_Tina-XP-M F10581_Tina-XP-M / LDC (Polar)

Luminaire: Ledil Oy F10581_Tina-XP-M F10581_Tina-XP-M
Lamps: 1 x Cree XP-E

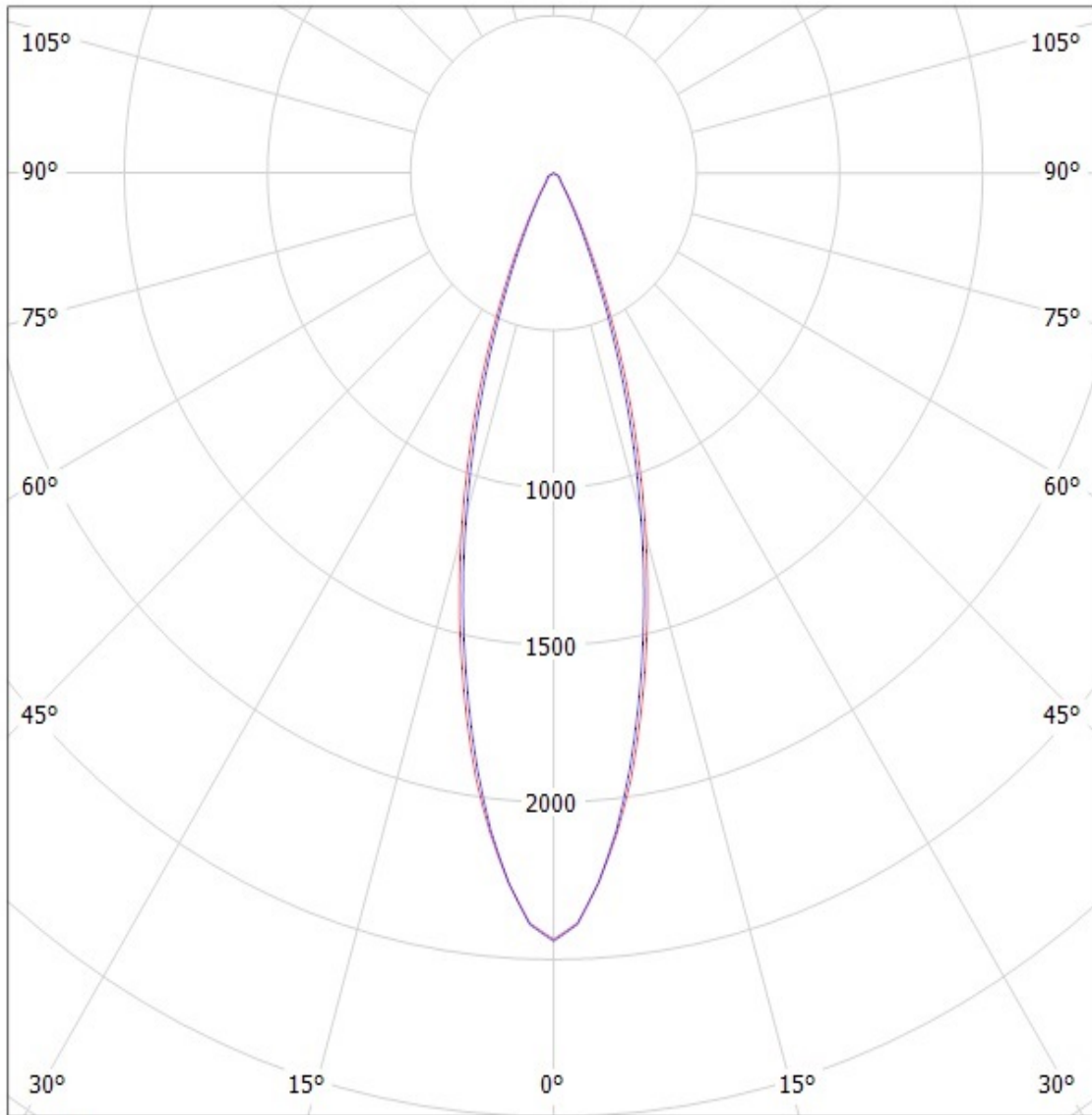

cd/klm

— C0 - C180 — C90 - C270

SIMULATED

FA11200_Tina-XP-OLedil Oy FA11200_Tina-XP-O FA11200_Tina-XP-O / LDC (Polar)

Luminaire: FA11200_Tina-XP-OLedil Oy FA11200_Tina-XP-O FA11200_Tina-XP-O

Lamps: 1 x Cree XP-E (White)

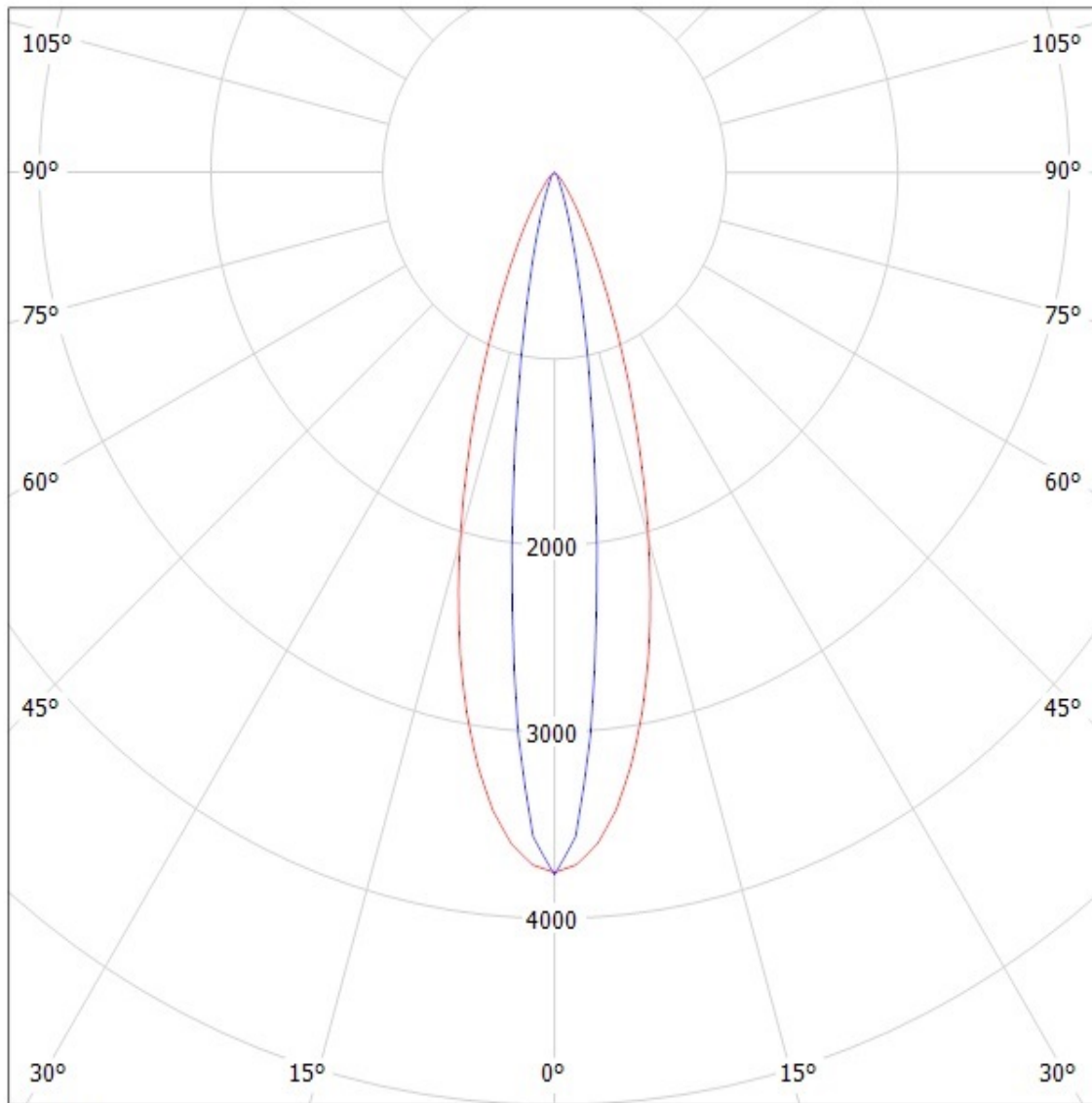

cd/klm

— C0 - C180 — C90 - C270

SIMULATED