

DETAILS

Product Number	C13301_STRADA-2X2-T3
Family	Strada
Type	Lens array
Color	clear
Diameter	50 x 50 mm
Height	7,1 mm
Style	square
Optic Material	PMMA
Holder Material	
Fastening	glue, pin, screw
Status	production ready
ROHS Compliant	Yes
Date Updated	12/05/2017



OPTICAL PROPERTIES

LED	Viewing Angle	Light Beam	Efficiency	cd/lm	Connector
SMD 5050	Asymmetric deg	Asymmetric	94 %	0.520	-
QUICK FLUX XTP 2x4 xxx LS G5	Asymmetric deg	Asymmetric	94 %	0.620	-
QUICK FLUX XTP 2x6 xxx LS G5	Asymmetric deg	Asymmetric	94 %	0.640	-
XP-G	Asymmetric deg	Asymmetric	94 %	0.700	-
XB-D	Asymmetric deg	Asymmetric	-	-	-
XM-L	Asymmetric deg	Asymmetric	-	-	-
XT-E	Asymmetric deg	Asymmetric	94 %	0.730	-
XM-L2	Asymmetric deg	Asymmetric	94 %	0.540	-
XP-G2	Asymmetric deg	Asymmetric	92 %	0.680	-
XQ-E	Asymmetric deg	Asymmetric	sim: 91 %	-	-
XP-E2	Asymmetric deg	Asymmetric	94 %	0.800	-
XP-L	Asymmetric deg	Asymmetric	94 %	0.540	-
XB-H	sim: Asymmetric	Asymmetric	sim: 91 %	-	-
XP-L HI	Asymmetric deg	Asymmetric	94 %	0.650	-
XHP35 HD	sim: Asymmetric	Asymmetric	sim: 90 %	-	-
XHP35 HI	sim: Asymmetric	Asymmetric	sim: 92 %	-	-
XP-L2	Asymmetric deg	Asymmetric	94 %	0.560	-
XP-G3	sim: Asymmetric	Asymmetric	sim: 93 %	sim: 0.560	-
XD16	Asymmetric deg	Asymmetric	94 %	0.860	-
XD16 2x2 cluster	Asymmetric deg	Asymmetric	94 %	0.600	-
H35C0 (LEMWA33)	Asymmetric deg	Asymmetric	94 %	0.610	-
H35C1 (LEMWA33)	Asymmetric deg	Asymmetric	94 %	0.700	-
LUXEON T	Asymmetric deg	Asymmetric	94 %	0.670	-
LUXEON Rebel ES	Asymmetric deg	Asymmetric	94 %	0.720	-
LUXEON R	Asymmetric deg	Asymmetric	94 %	0.740	-

OPTICAL PROPERTIES

LED	Viewing Angle	Light Beam	Efficiency	cd/lm	Connector
LUXEON Z ES	Asymmetric deg	Asymmetric	94 %	0.930	-
LUXEON H50-2	sim: Asymmetric	Asymmetric	-	-	-
LUXEON Q	Asymmetric deg	Asymmetric	94 %	0.700	-
LUXEON MZ	Asymmetric deg	Asymmetric	94 %	0.680	-
LUXEON TX	Asymmetric deg	Asymmetric	94 %	0.660	-
LUXEON 5050	Asymmetric deg	Asymmetric	94 %	0.550	-
LUXEON V	Asymmetric deg	Asymmetric	94 %	0.570	-
NCSxx19A	Asymmetric deg	Asymmetric	-	-	-
NVSxx19A	Asymmetric deg	Asymmetric	-	-	-
NVSxx19B/NVSxx19C	Asymmetric deg	Asymmetric	94 %	0.710	-
NS9x383	Asymmetric deg	Asymmetric	95 %	0.600	-
NWSx229A	Asymmetric deg	Asymmetric	94 %	0.590	-
NVSW3x9A	Asymmetric deg	Asymmetric	94 %	0.670	-
NVSxE21A	Asymmetric deg	Asymmetric	94 %	1.040	-
NVSxx19B/NVSxx19C	Asymmetric deg	Asymmetric	94 %	0.640	-
NVSW219D	Asymmetric deg	Asymmetric	94 %	0.550	-
Oslon Square PC	Asymmetric deg	Asymmetric	94 %	0.690	-
Oslon Square Gen3	sim: Asymmetric	Asymmetric	sim: 91 %	sim: 0.650	-
Duris S8	sim: Asymmetric	Asymmetric	sim: 93 %	sim: 0.590	-
OSCONIQ P 3737 (2W version)	sim: Asymmetric	Asymmetric	sim: 92 %	sim: 0.680	-
OSCONIQ P 3737 (3W version)	sim: Asymmetric	Asymmetric	sim: 94 %	sim: 0.590	-
PrevaLED Brick DC 2x8	sim: Asymmetric	Asymmetric	sim: 91 %	sim: 0.650	-
Oslon SSL 80	Asymmetric deg	Asymmetric	94 %	0.580	-
Fortimo FastFlex LED board 2x8 DA G4	Asymmetric deg	Asymmetric	94 %	0.610	-
Fortimo FastFlex LED board 2x8 DAX G4	sim: Asymmetric	Asymmetric	sim: 93 %	sim: 0.000	-
LH351A(3535)	Asymmetric deg	Asymmetric	94 %	0.750	-
LH351B	Asymmetric deg	Asymmetric	94 %	0.560	-
LH351Z	Asymmetric deg	Asymmetric	94 %	0.590	-
LH351D	Asymmetric deg	Asymmetric	94 %	0.520	-
LH351C	Asymmetric deg	Asymmetric	94 %	0.600	-
LH508A	Asymmetric deg	Asymmetric	94 %	0.550	-
Z5P	Asymmetric deg	Asymmetric	94 %	0.720	-
Acrich MJT 4040	Asymmetric deg	Asymmetric	94 %	0.650	-
Z5M	Asymmetric deg	Asymmetric	94 %	0.700	-
Z5M1/Z5M2	Asymmetric deg	Asymmetric	94 %	0.700	-
Z8Y22P	Asymmetric deg	Asymmetric	94 %	0.720	-
Z8Y22	sim: Asymmetric	Asymmetric	sim: 94 %	sim: 0.800	-
Z8Y22	Asymmetric deg	Asymmetric	94 %	0.850	-
TL1L3	Asymmetric deg	Asymmetric	94 %	0.480	-
TL1L4	Asymmetric deg	Asymmetric	91 %	0.640	-
RLE G1 49x223mm 4000lm xxx EXC OT	Asymmetric deg	Asymmetric	94 %	0.660	-
RLE G1 49x245mm 4000lm xxx EXC OT	Asymmetric deg	Asymmetric	94 %	0.660	-



PRODUCT DATASHEET

Strada series

last update 12/5/2017

RLE G1 49x121mm 2000lm xxx EXC OTAsymmetric degAsymmetric 94 % 0.660 -



PRODUCT DATASHEET

Strada series

last update 12/5/2017

RLE G1 49x133mm 2000lm xxx EXC OTAsymmetric degAsymmetric 94 % 0.660 -

D C B A

4

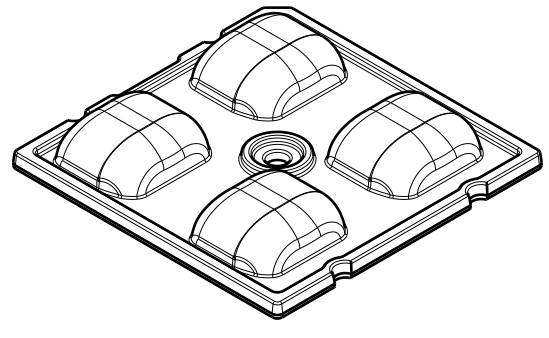
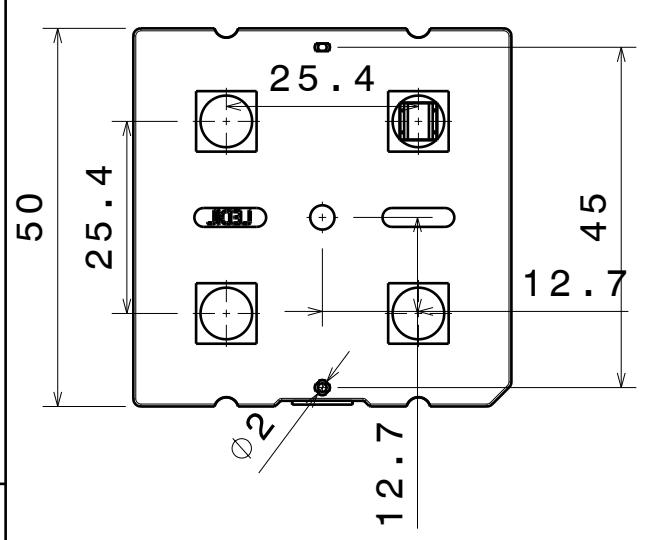

3

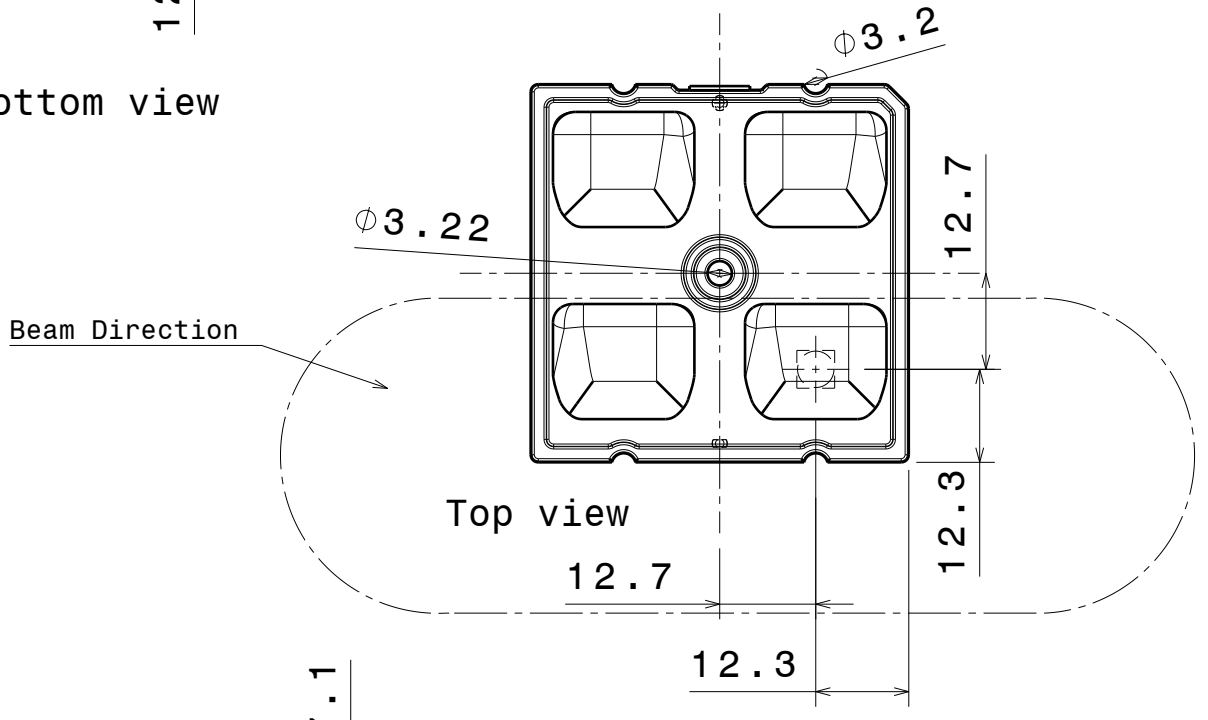

2

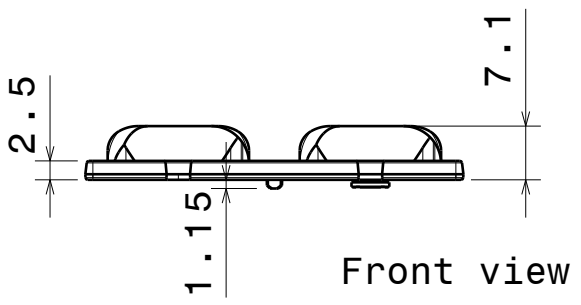

4

3

2

INDEX	PART NO	DESCRIPTION	MATERIAL	COLOUR
1	C13301	STRADA-2X2-T3	PMMA	

Tolerances if not otherwise shown
 According to DIN ISO 2768-1
 Linear measures:
 Up to 30mm class M, otherwise class C.
 According to DIN ISO 2768-2
 Form and position: class L

LEDiL LediL Oy
 Salorankatu 10
 FIN 24240 SALO
 Finland

THIRD ANGLE PROJECTION:

DRAWING TITLE
STRADA-2X2-T3

1

This drawing is the property of LEDiL Oy. It may not be reproduced, copied or communicated without a written agreement with LEDiL Oy."

SIZE	C13301		
A4			

1

SCALE	1:1	WEIGHT		SHEET	1/1
-------	-----	--------	--	-------	-----

D

A

Luminaire: LEDiL Oy C13301_STRADA-2X2-T3 (Bridgelux_5050_Gen2)
Lamps: 1 x Bridgelux_5050_Gen2_2x2_(BXEP-57C-435-09B)_1447.45lm@250mA_CCT=5700K_P=8.29761W_I=0.25A

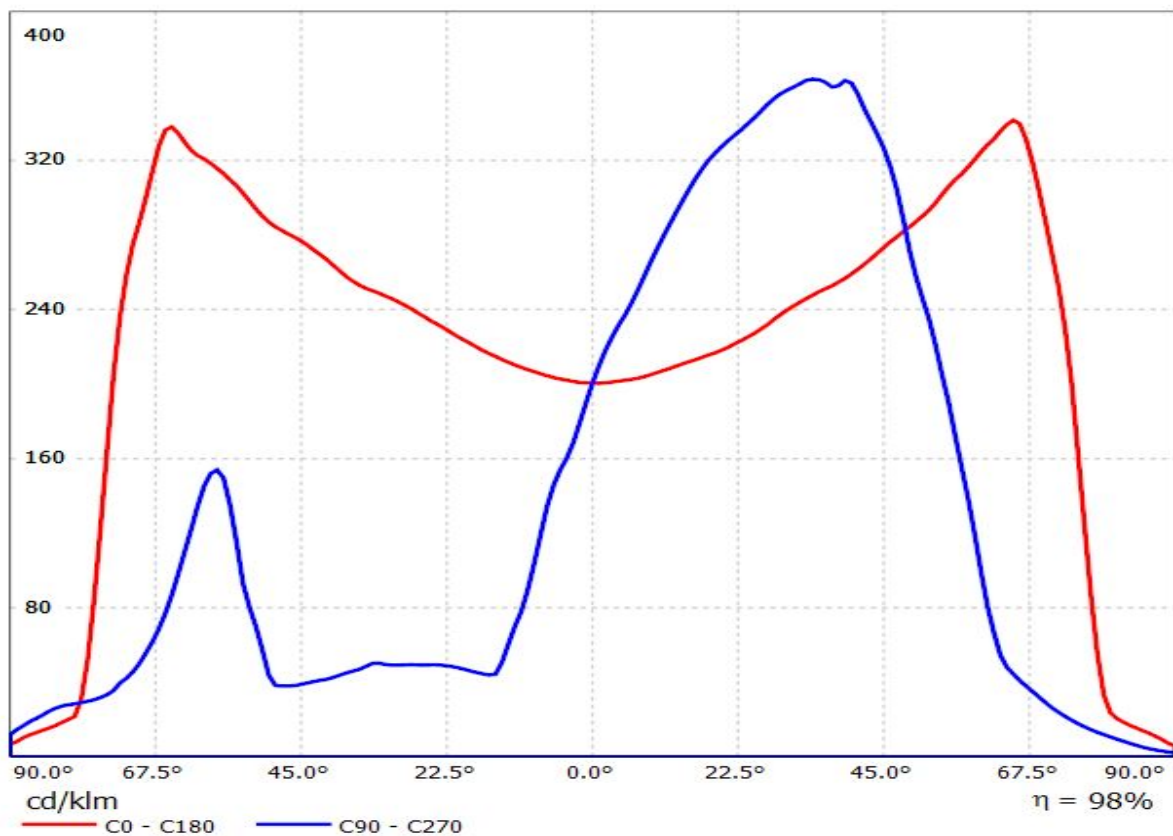

Luminaire: LEDiL Oy C13301_STRADA-2X2-T3_(QUICK_FLUX_XTP_2x4_740_LS_G5)
Lamps: 1 x QUICK_FLUX_XTP_2x4_740_LS_G5_969.2lm@250mA_P=5.68795W_I=0.25A

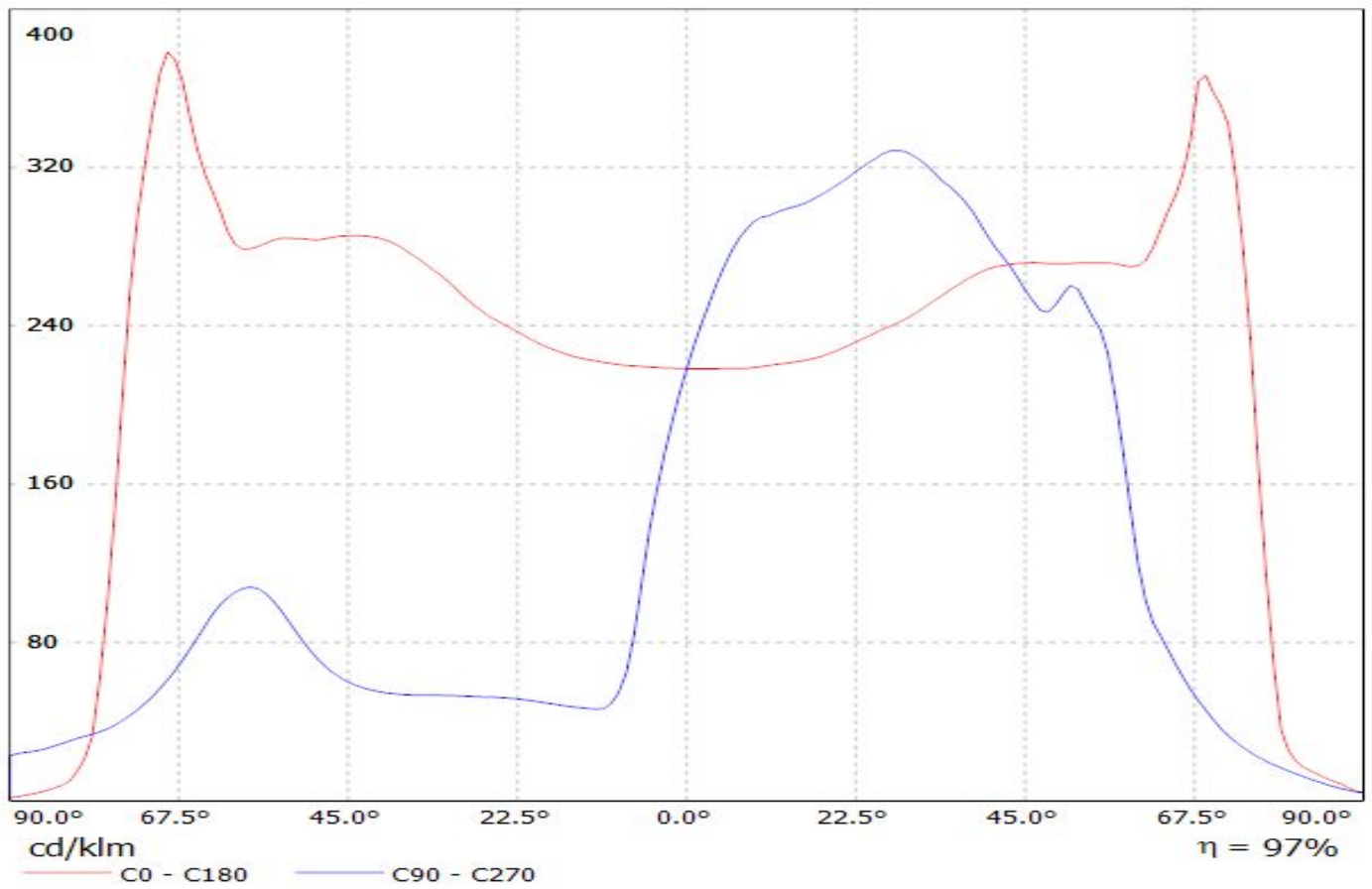

Luminaire: Ledil C13301_STRADA-2X2-T3_(QUICK_FLUX_XTP_2x6_740_LS_G5)
Lamps: 1 x QUICK_FLUX_XTP_2x6_740_LS_G5_1447.53lm@250mA_P=8.58406W_η=0.25A

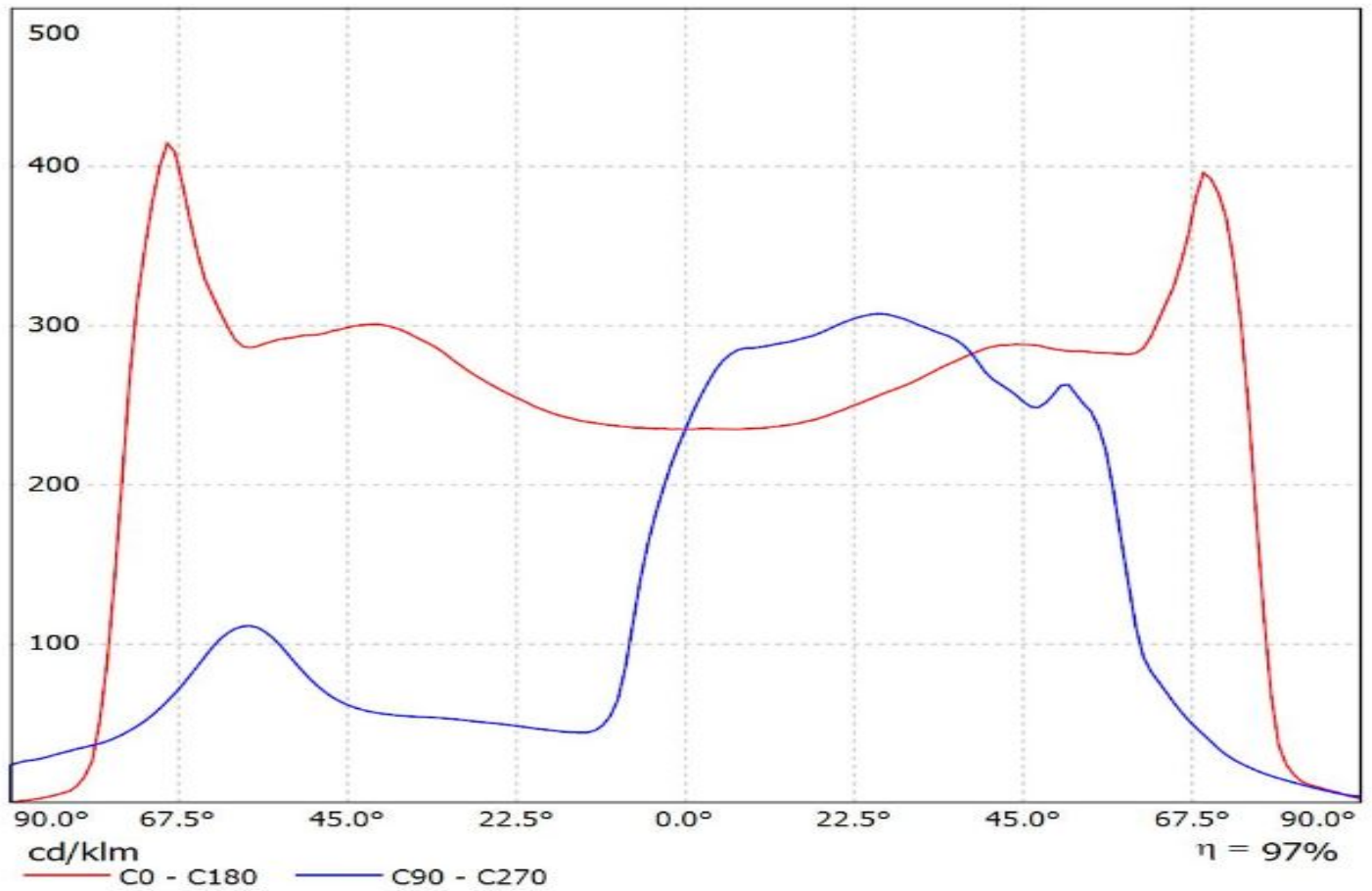

LEDiL Oy C13301_STRADA-2X2-T3_(XP-G) Eff.94.2% / LDC (Linear)

Luminaire: LEDiL Oy C13301_STRADA-2X2-T3_(XP-G) Eff.94.2%
Lamps: 1 x CREE XP-G2 (259lm@250mA)

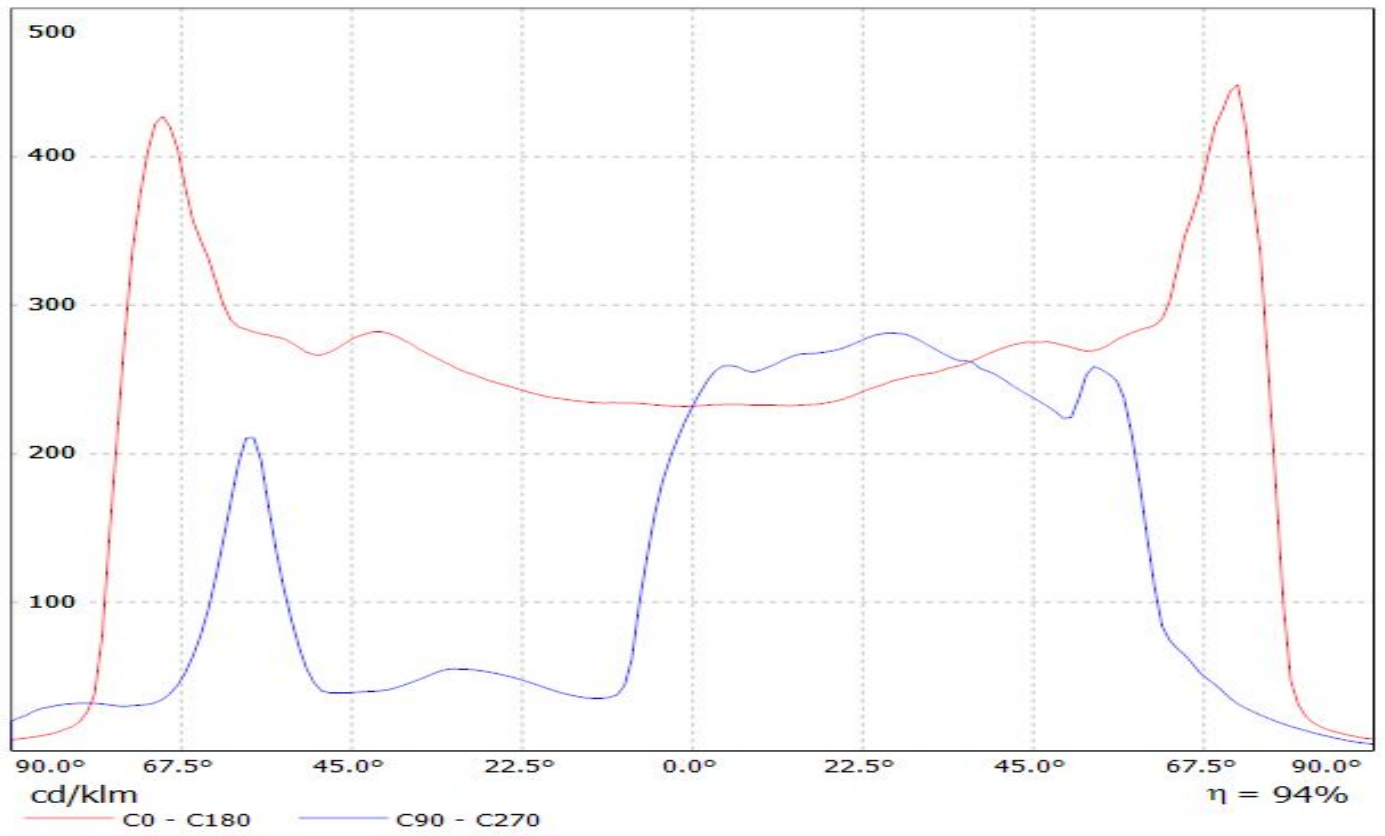

LEDiL Oy C13301_STRADA-2X2-T3_(XT-E) 95.0% / LDC (Linear)

Luminaire: LEDiL Oy C13301_STRADA-2X2-T3_(XT-E) 95.0%
Lamps: 1 x CREE_XT-E (390lm@250mA)

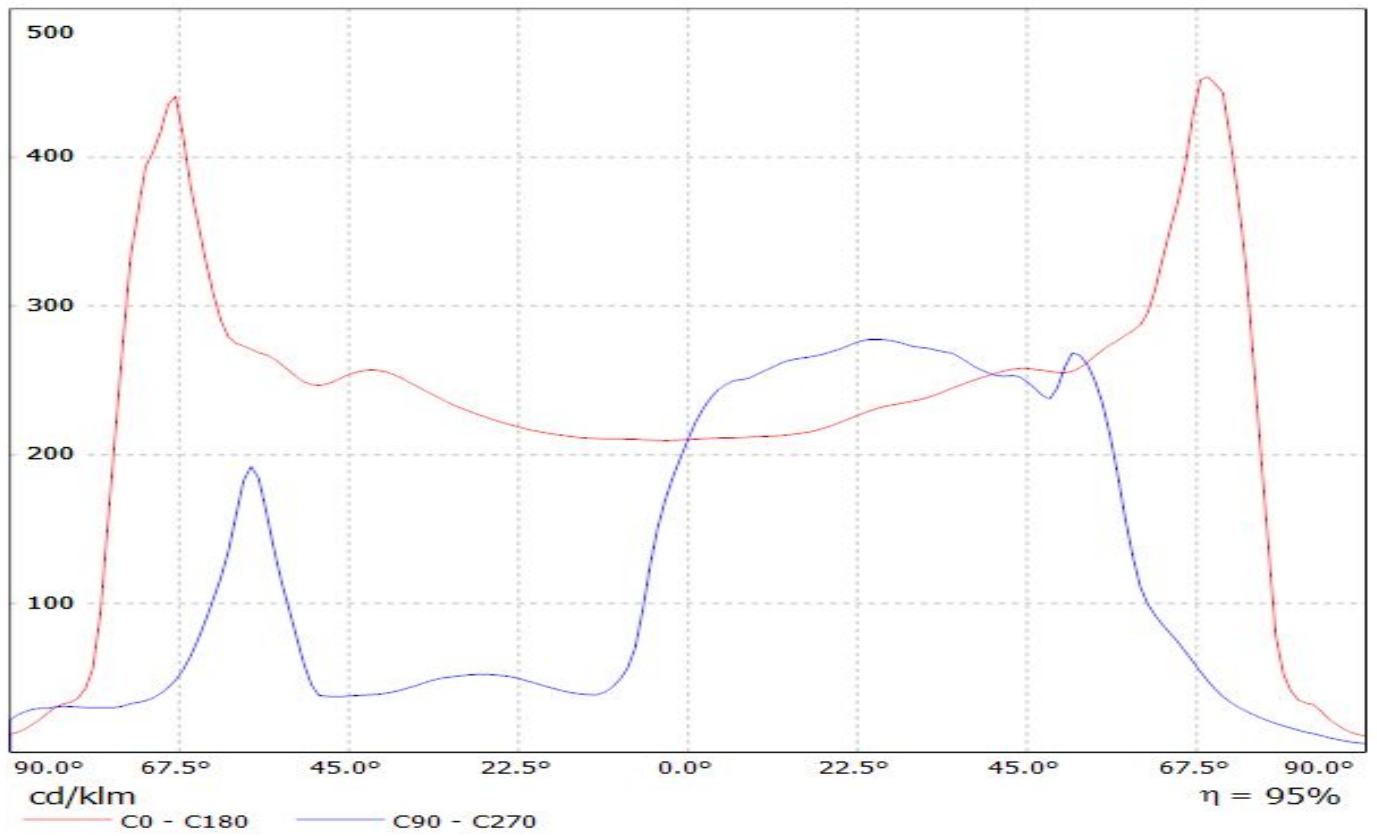

LEDiL Oy C13301_STRADA-2X2-T3_(XM-L2) Eff.94.3% / LDC (Linear)

Luminaire: LEDiL Oy C13301_STRADA-2X2-T3_(XM-L2) Eff.94.3%

Lamps: 1 x XM-L2 (366lm@250mA)

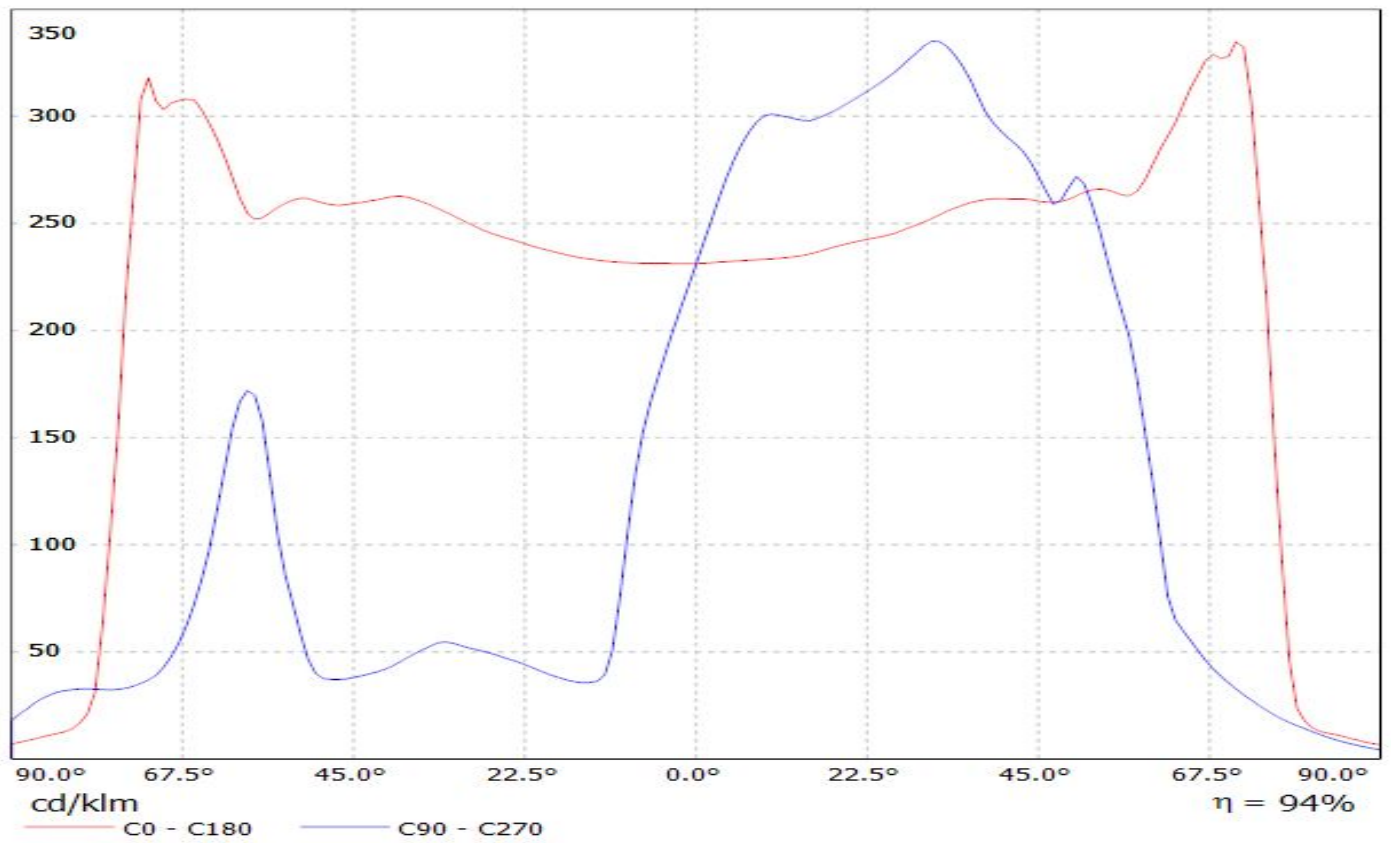

LEDiL Oy C13301_STRADA-2X2-T3_(XP-G2) Eff.92.0% / LDC (Linear)

Luminaire: LEDiL Oy C13301_STRADA-2X2-T3_(XP-G2) Eff.92.0%
Lamps: 1 x CREE XP-G2 (433lm@250mA)

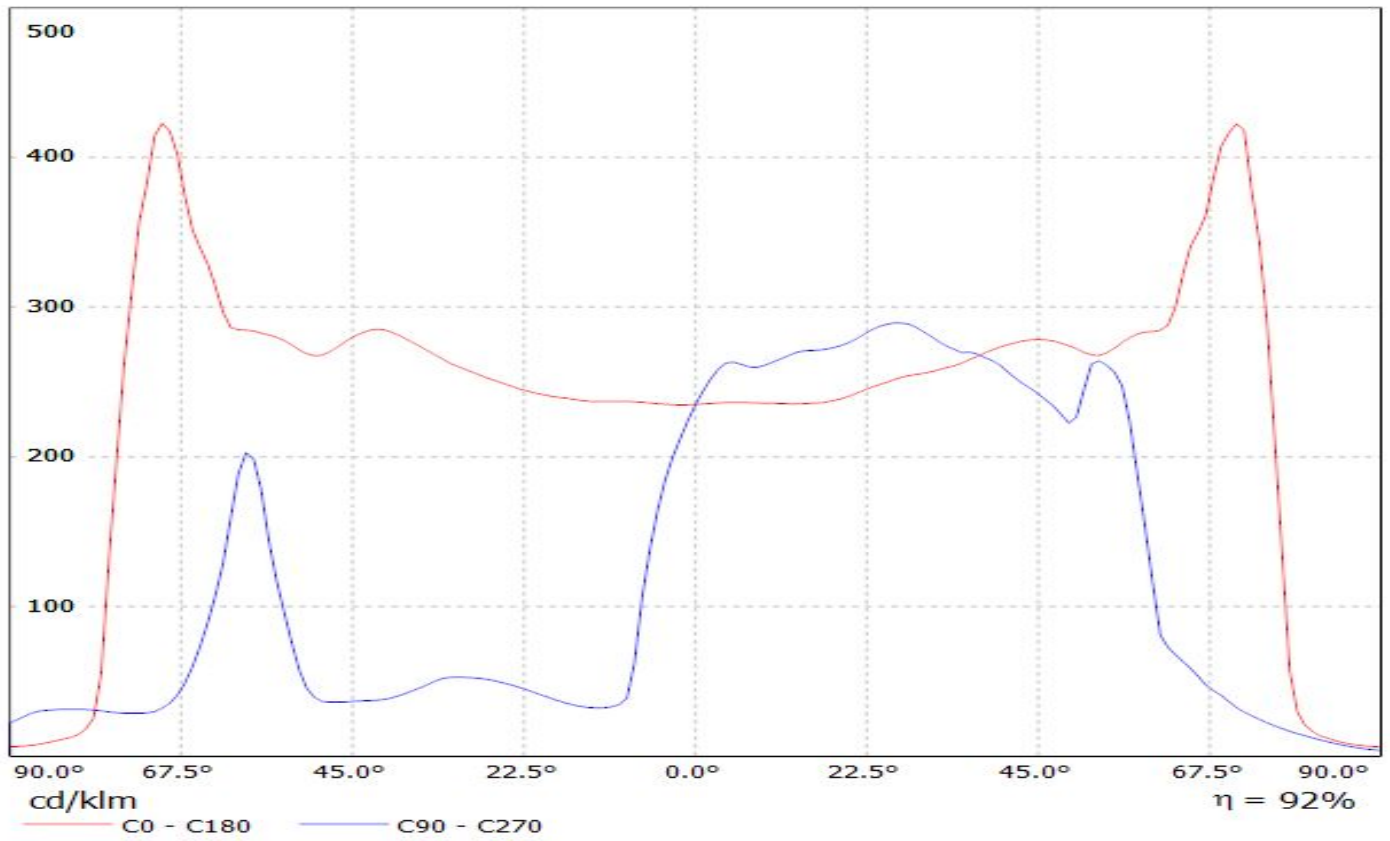

LEDiL Oy C13301_STRADA-2X2-T3_(XP-E2) Eff.94.0% / LDC (Linear)

Luminaire: LEDiL Oy C13301_STRADA-2X2-T3_(XP-E2) Eff.94.0%
Lamps: 1 x CREE_XP-E2_2x2_(XPEBWT-L1-7B4-Q4-0-01)
_340.57lm@250mA_P=2.92366W_I=249.8mA

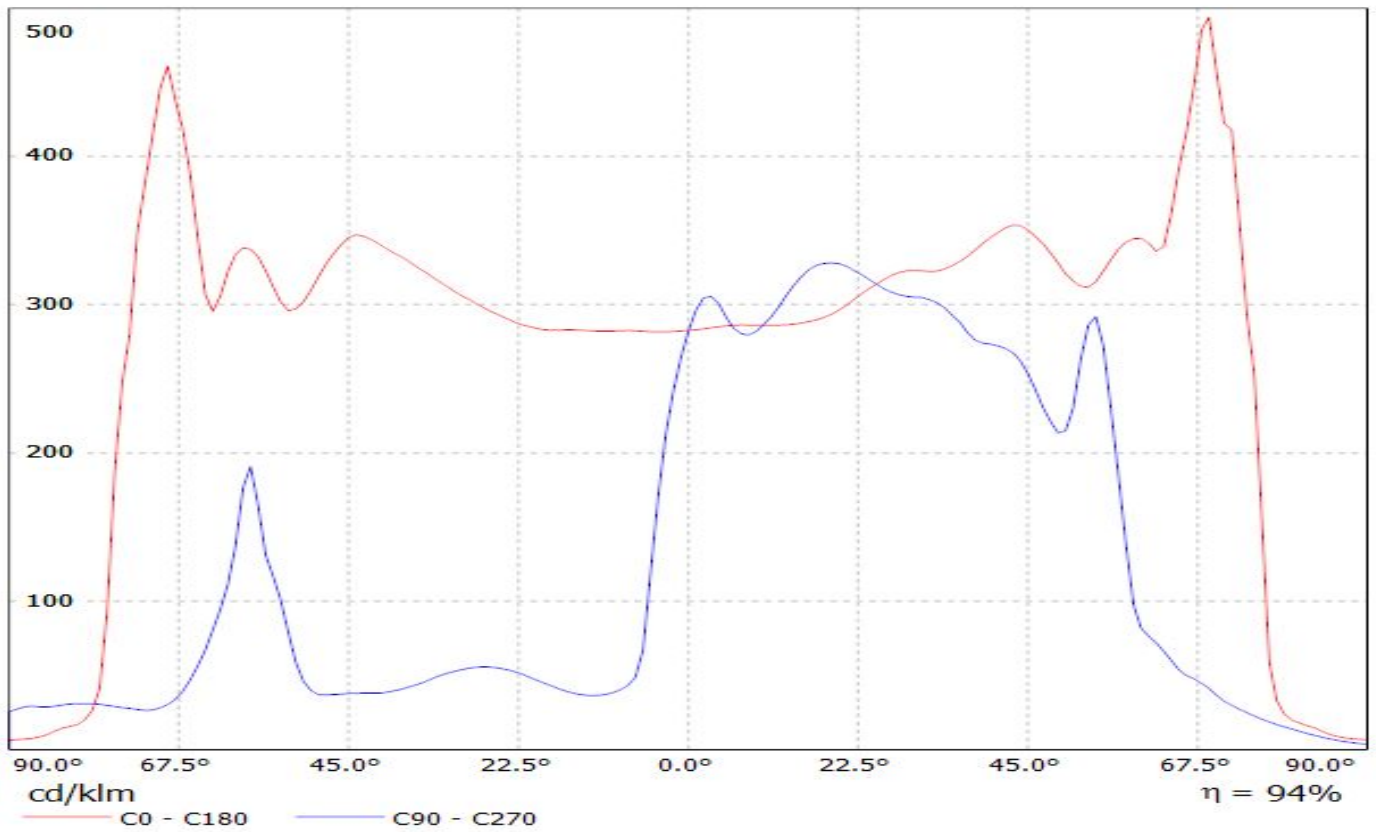

Luminaire: LEDiL Oy C13301_STRADA-2x2-T3_(XP-L)

Lamps: 1 x CREE_XP-L_2x2_(XPLAWT-0-1B0-V40-00-0001)_514lm@250mA_CCT=7600K_P=2.79963W_I=249.9mA

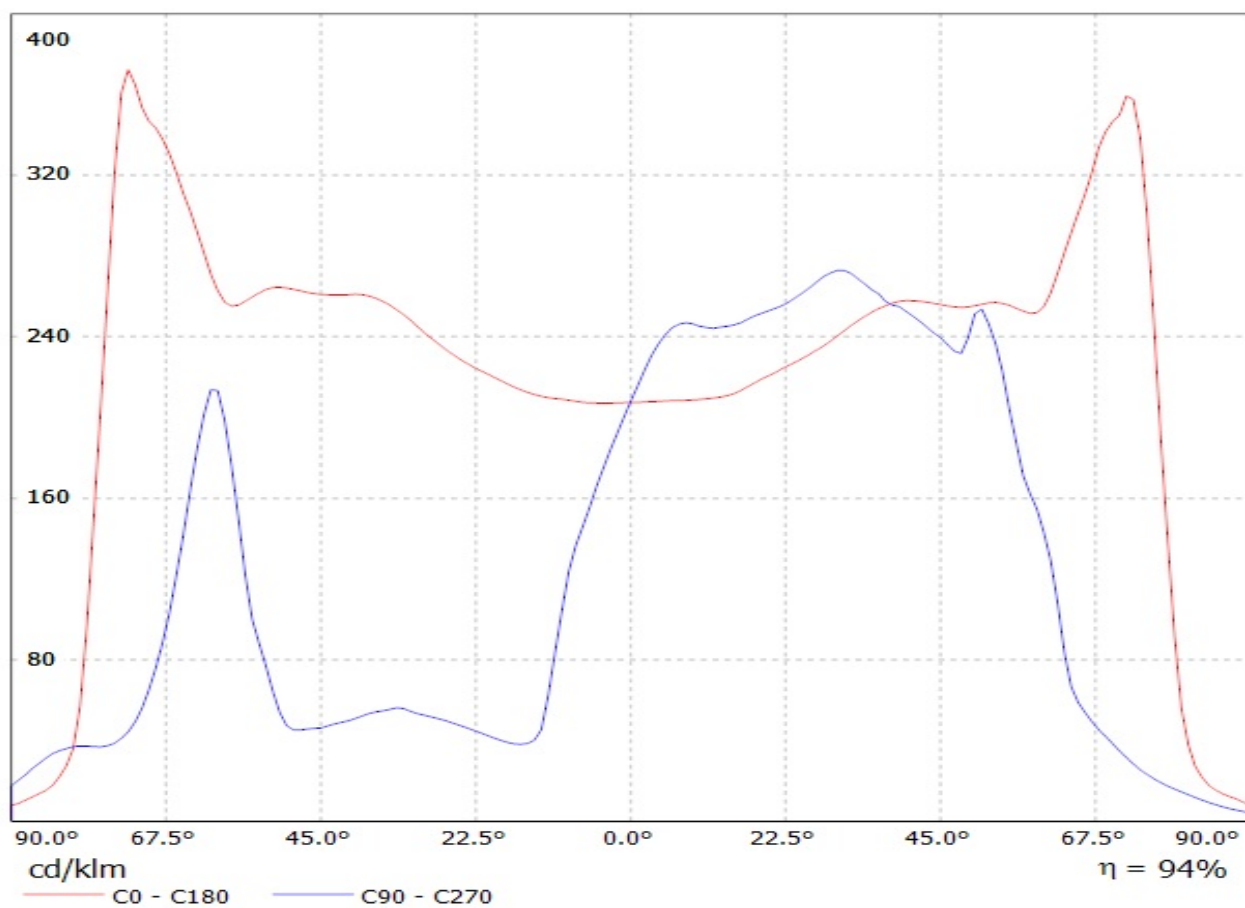

Luminaire: LEDiL Oy C13301_STRADA-2X2-T3_(XP-L_HI)
Lamps: 1 x Cree_XP-L_HI_(2x2)_ (XPLAWT-H-5A3-U60-013-0001)
_455.077lm@250mA_P=2.84011W_I=0.2499A

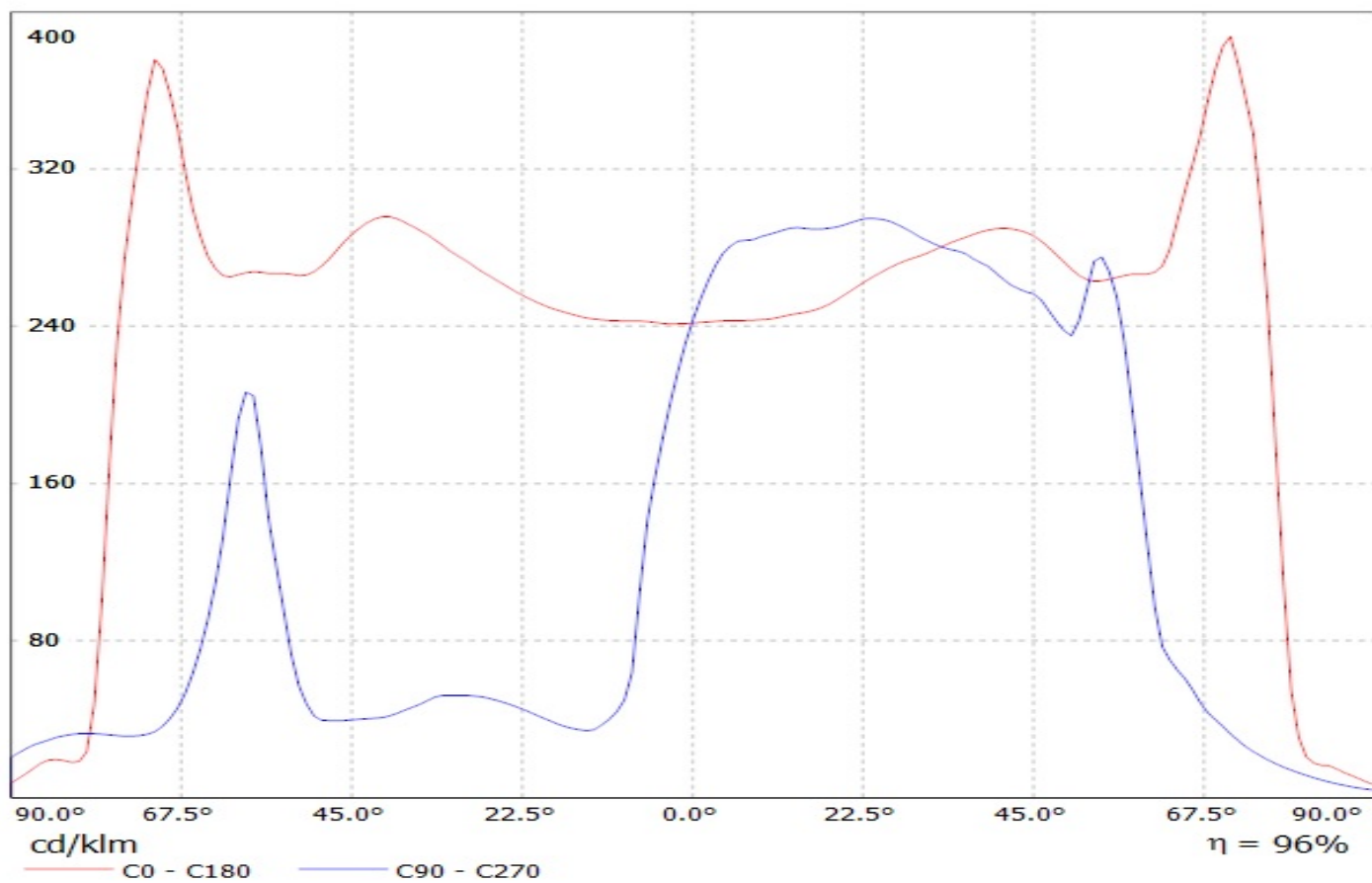

Luminaire: Ledil C13301_STRADA-2X2-T3_(XP-L2)

Lamps: 1 x Cree_XP-L2_2x2_(XPLBWT-00-0000-000BV50E3)550.93lm@250mA_P=2.7815W_I=0.25A

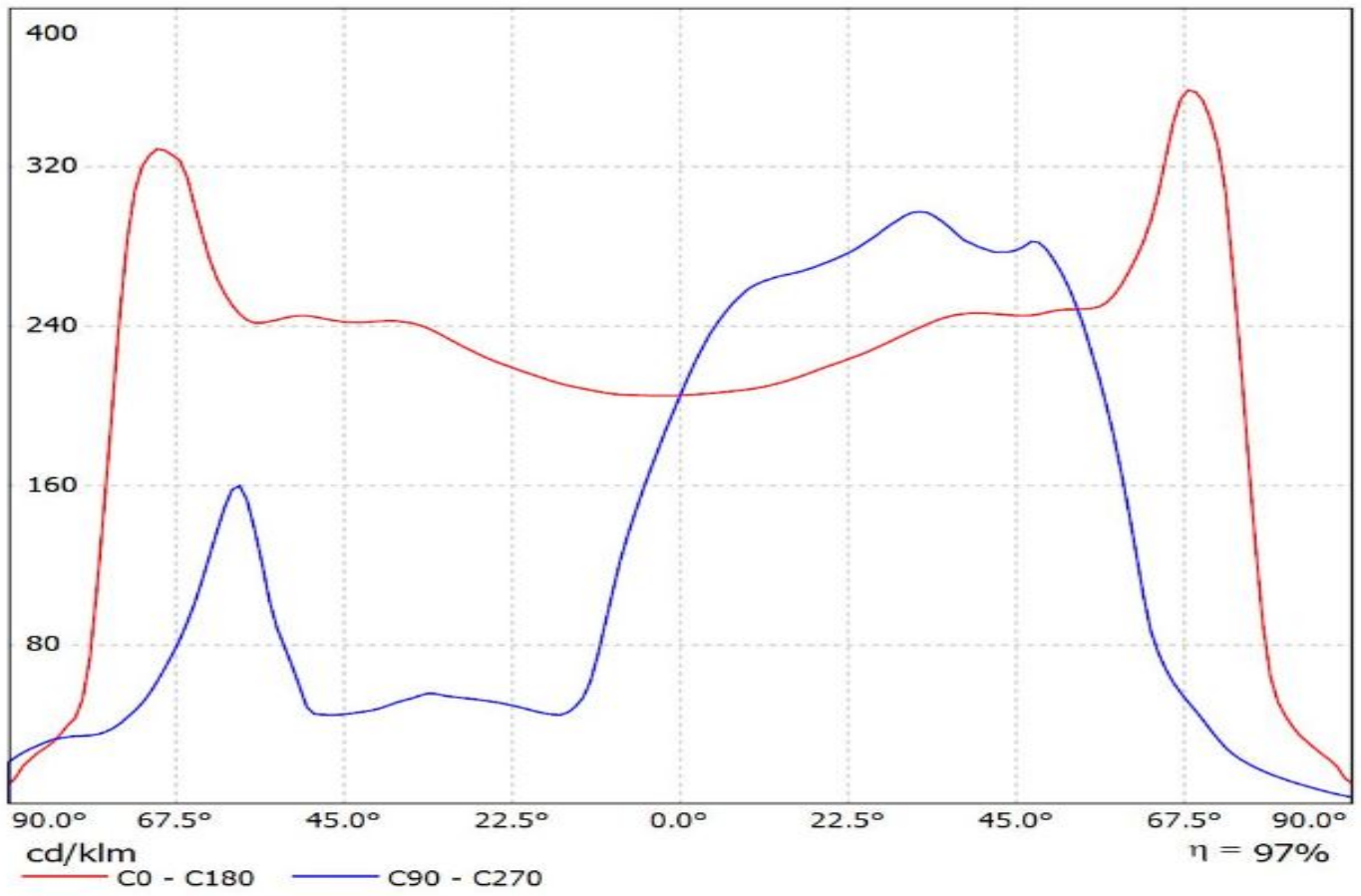

Luminaire: Ledil Oy C13301_STRADA-2X2-T3_(XP-G3)_SIMULATED
Lamps: 1 x Cree XP-G3

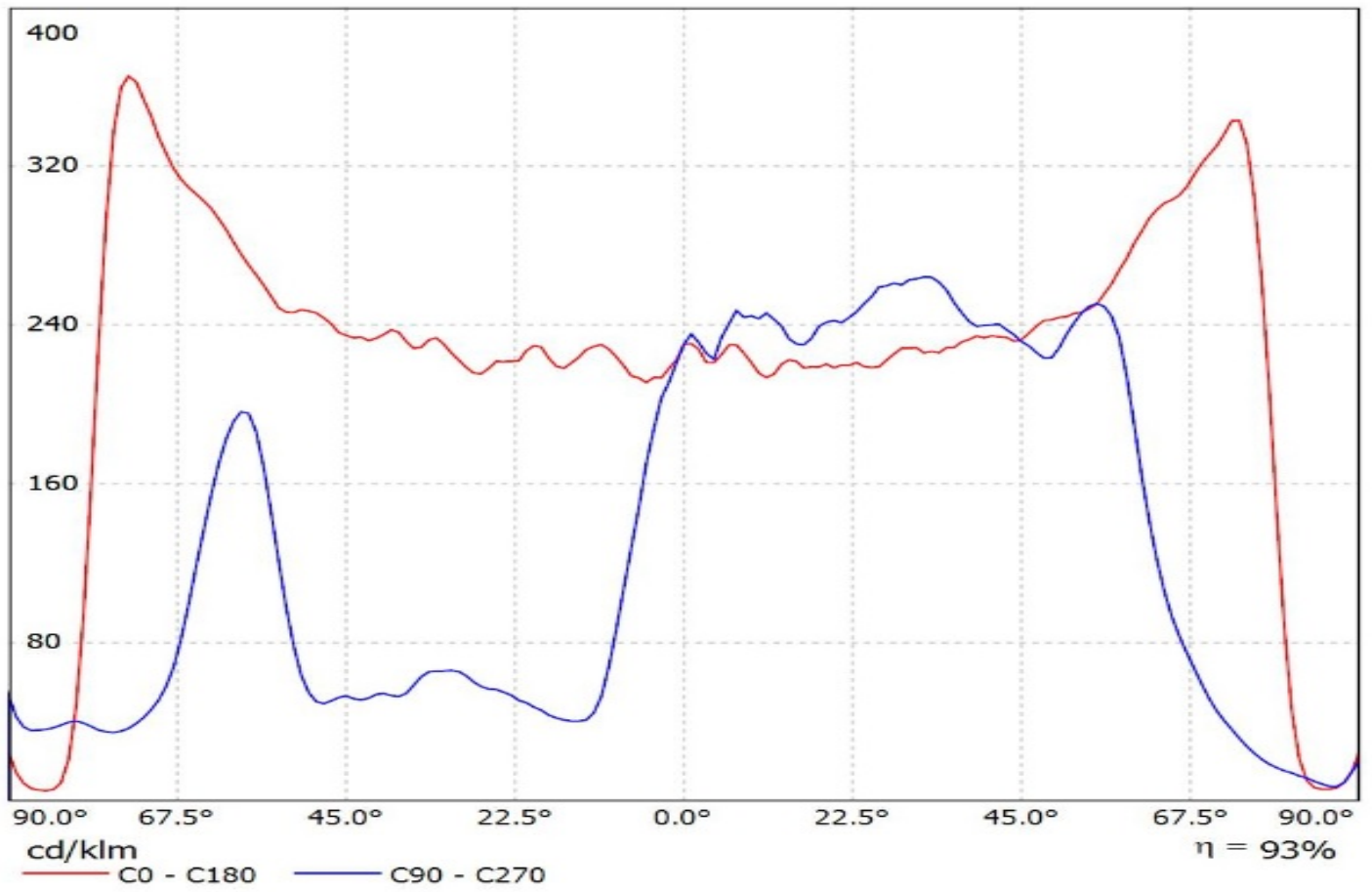

Luminaire: Ledil C13301_STRADA-2X2-T3_(XD16)

Lamps: 1 x Cree_XD16_2x2_(XD16AWT-H-2B0-S20-0B-002)_453.677lm@250mA_CCT=5700K_P=2.78289W_I=0.25A

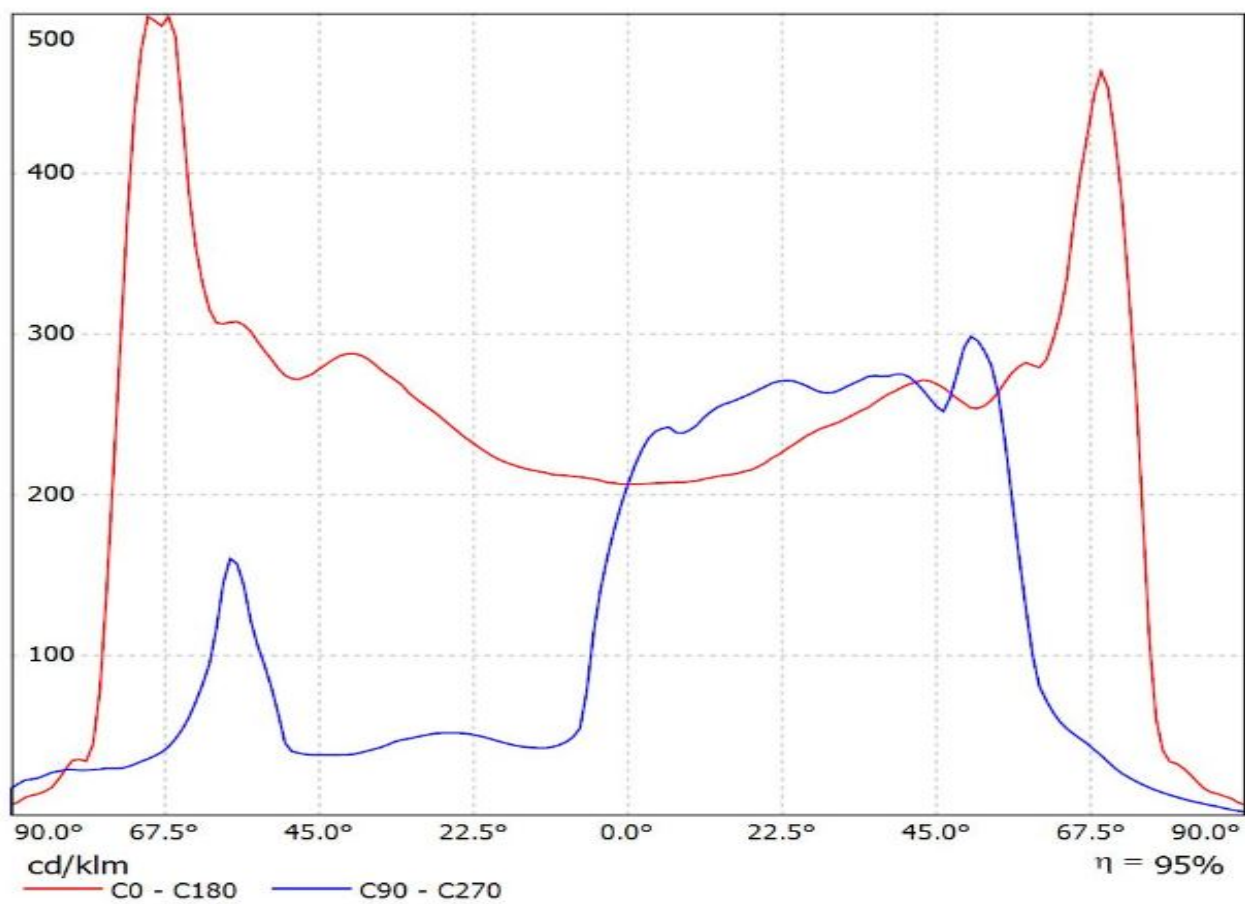

Luminaire: LEDiL Oy C13301_STRADA-2X2-T3_(XD16_Cluster16)

Lamps: 1 x Cree_XD16_2x2cluster_(XD16AWT-H-2B0-S20-0B-002)_1763.39lm@250mA_CCT=5700K_P=10.926W_U=43.738V

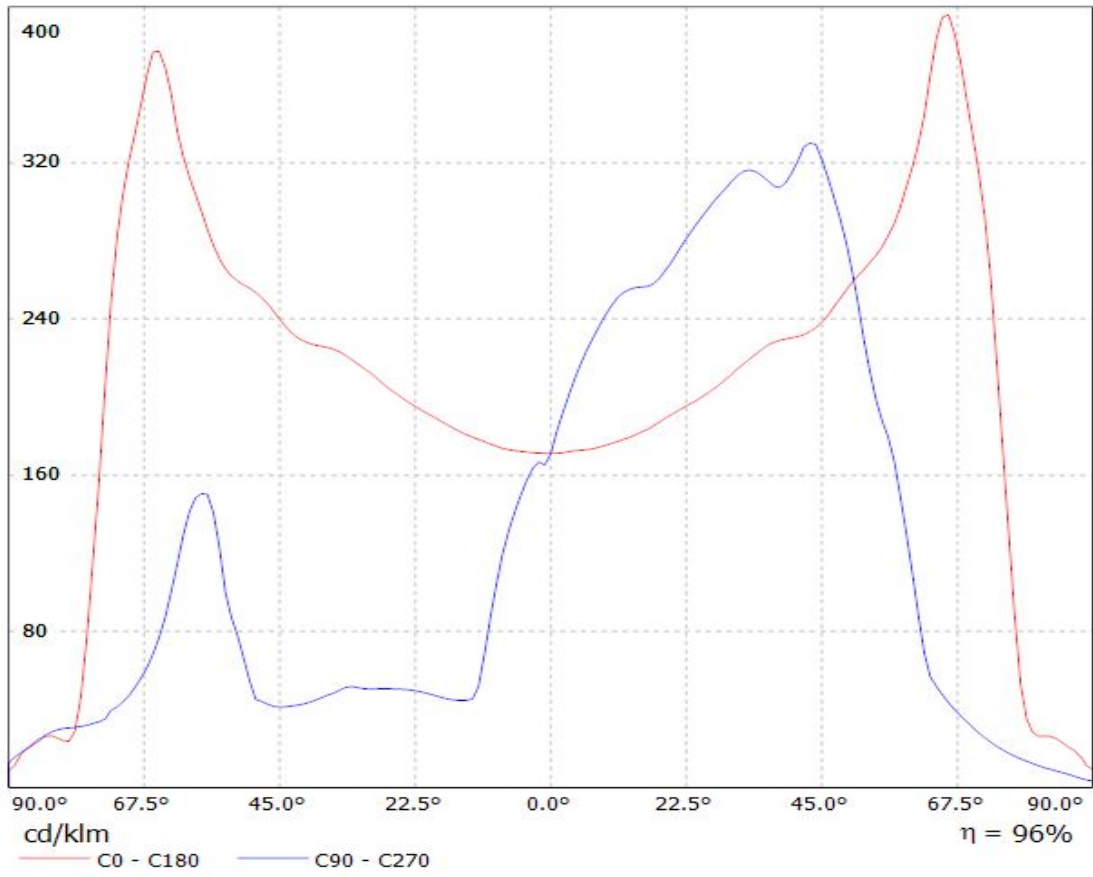

LEDiL Oy C13301_STRADA-2X2-T3_(LG_3535) Eff.94.4% / LDC (Linear)

Luminaire: LEDiL Oy C13301_STRADA-2X2-T3_(LG_3535) Eff.94.4%
Lamps: 1 x LG_3535_Ceramic_2x2 (374lm@250mA)

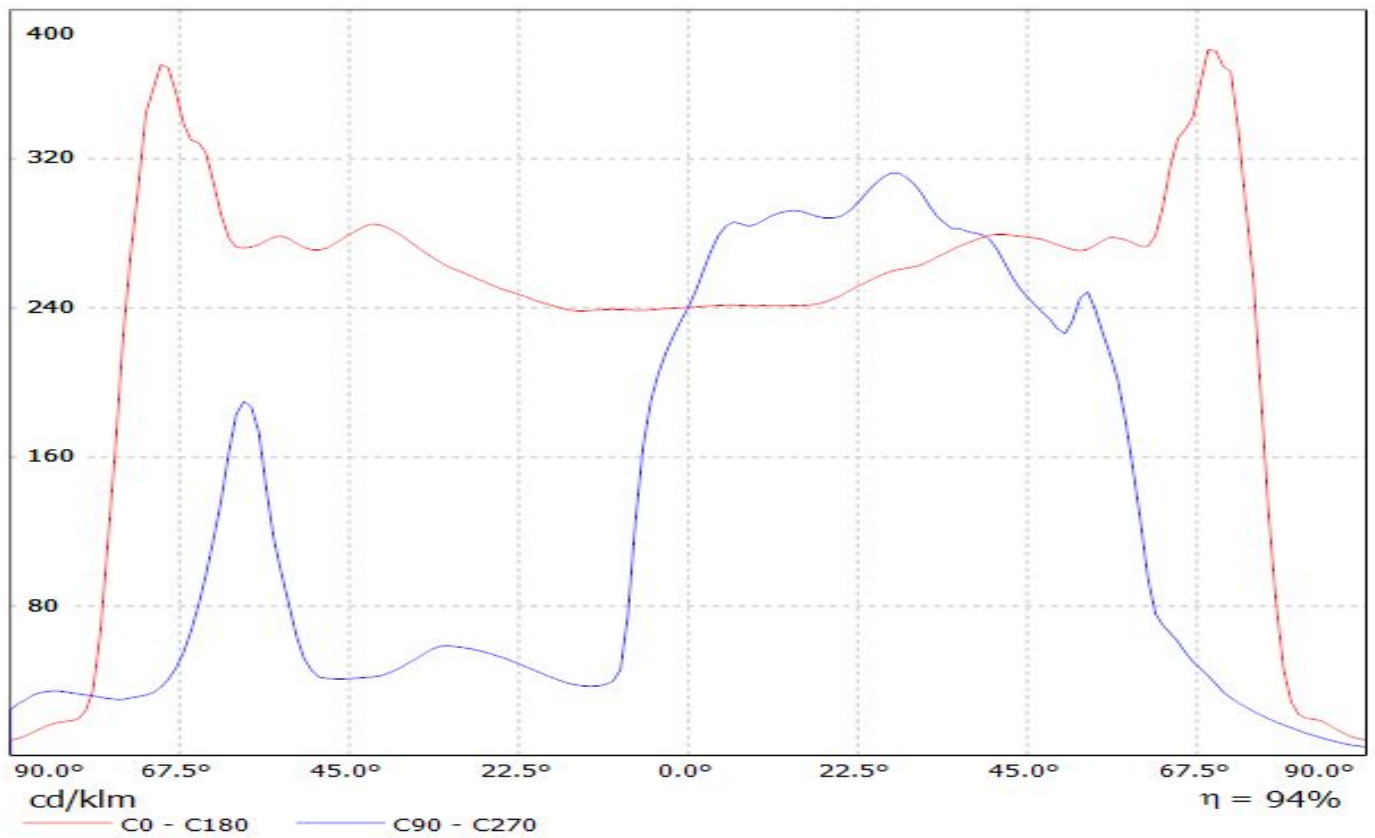

LEDiL Oy C13301_STRADA-2X2-T3_(LG-3535-CERAMIC-GEN2) Eff.94.0% / LDC (Linear)

Luminaire: LEDiL Oy C13301_STRADA-2X2-T3_(LG-3535-CERAMIC-GEN2) Eff.94.0%
Lamps: 1 x LG-3535-CERAMIC-GEN2_2x2_475.25lm@250mA_P=2.8651W_CCT=6562K_I=249.9mA

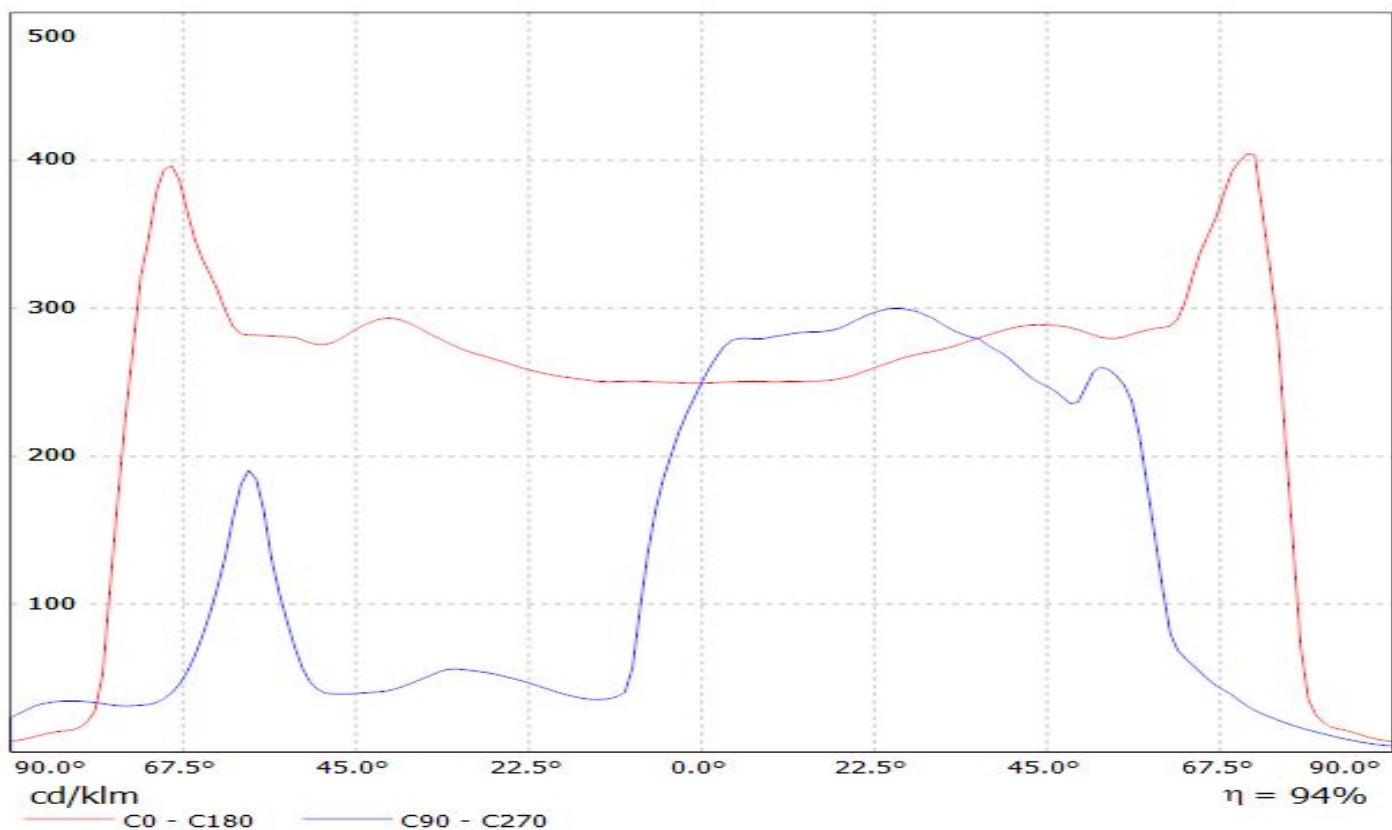

LEDiL Oy C13301_STRADA-2x2-T3_(LUXEON_T) Eff.93.9% / LDC (Linear)

Luminaire: LEDiL Oy C13301_STRADA-2x2-T3_(LUXEON_T) Eff.93.9%
Lamps: 1 x LUXEON_T (294lm@250mA)

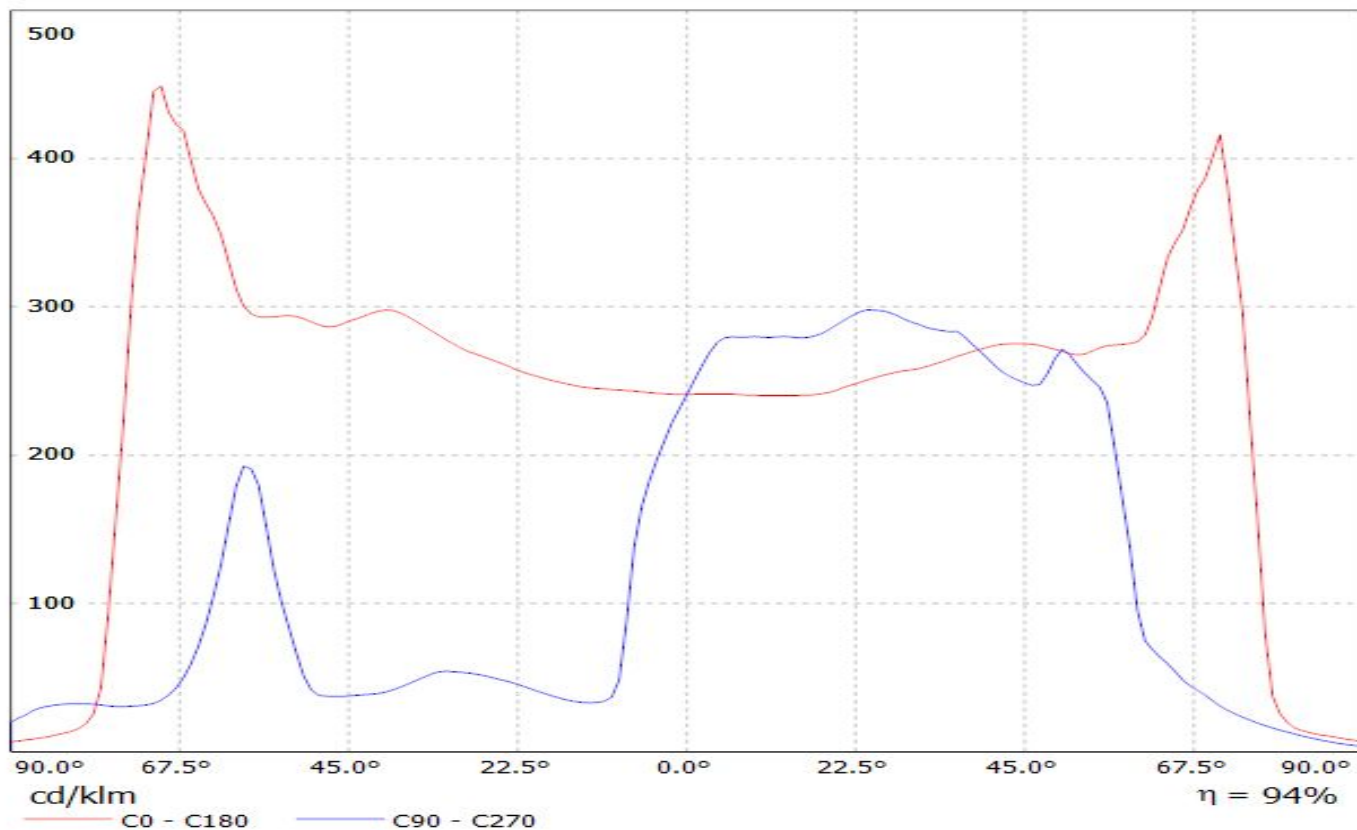

LEDiL Oy C13301_STRADA-2X2-T3_(Rebel-ES) Eff.94.1% / LDC (Linear)

Luminaire: LEDiL Oy C13301_STRADA-2X2-T3_(Rebel-ES) Eff.94.1%
Lamps: 1 x Rebel-ES (341lm@250mA)

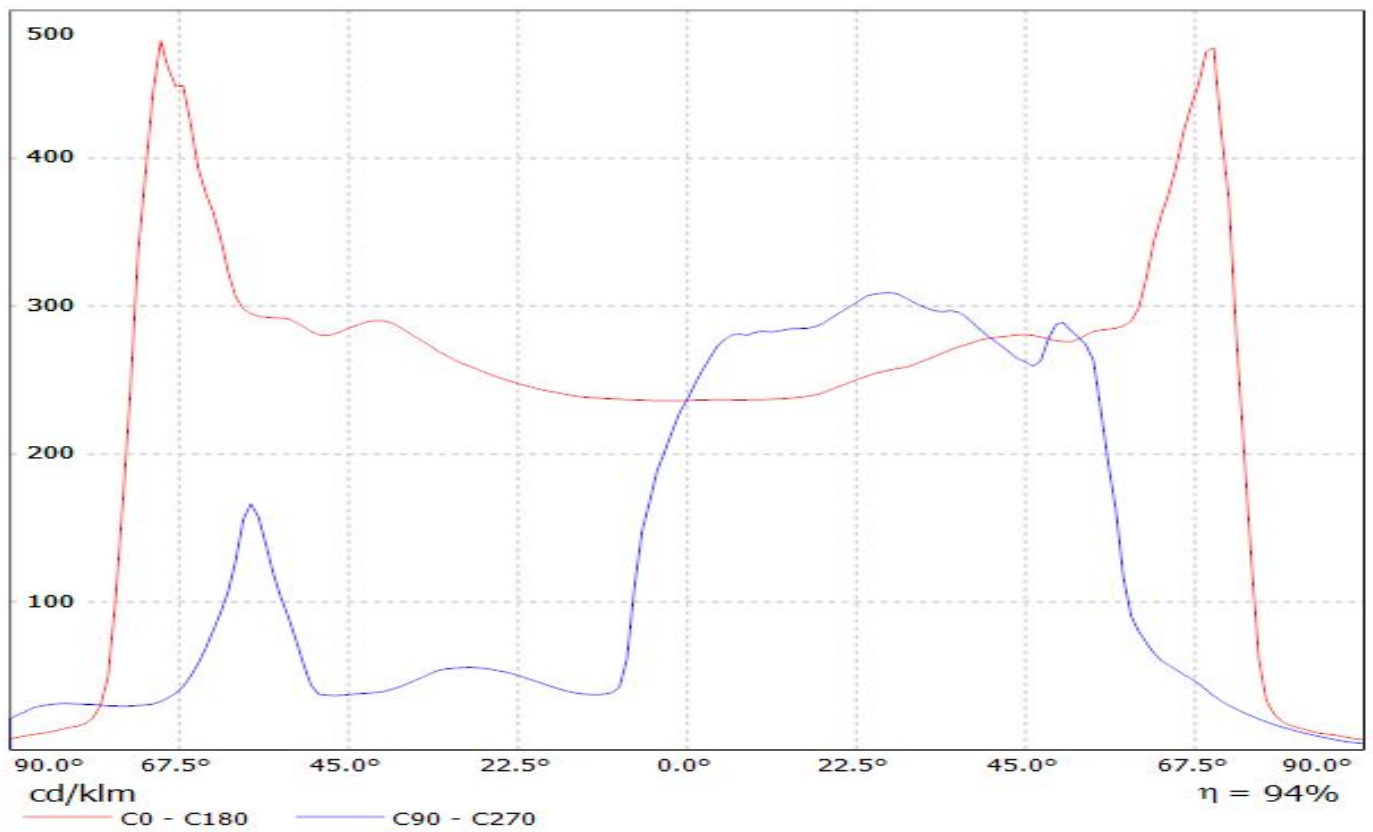

LEDiL Oy C13300_STRADA-2X2-T2_(LUXEON_R) Eff.94.4% / LDC (Linear)

Luminaire: LEDiL Oy C13300_STRADA-2X2-T2_(LUXEON_R) Eff.94.4%
Lamps: 1 x LUXEON_R (315lm@250mA)

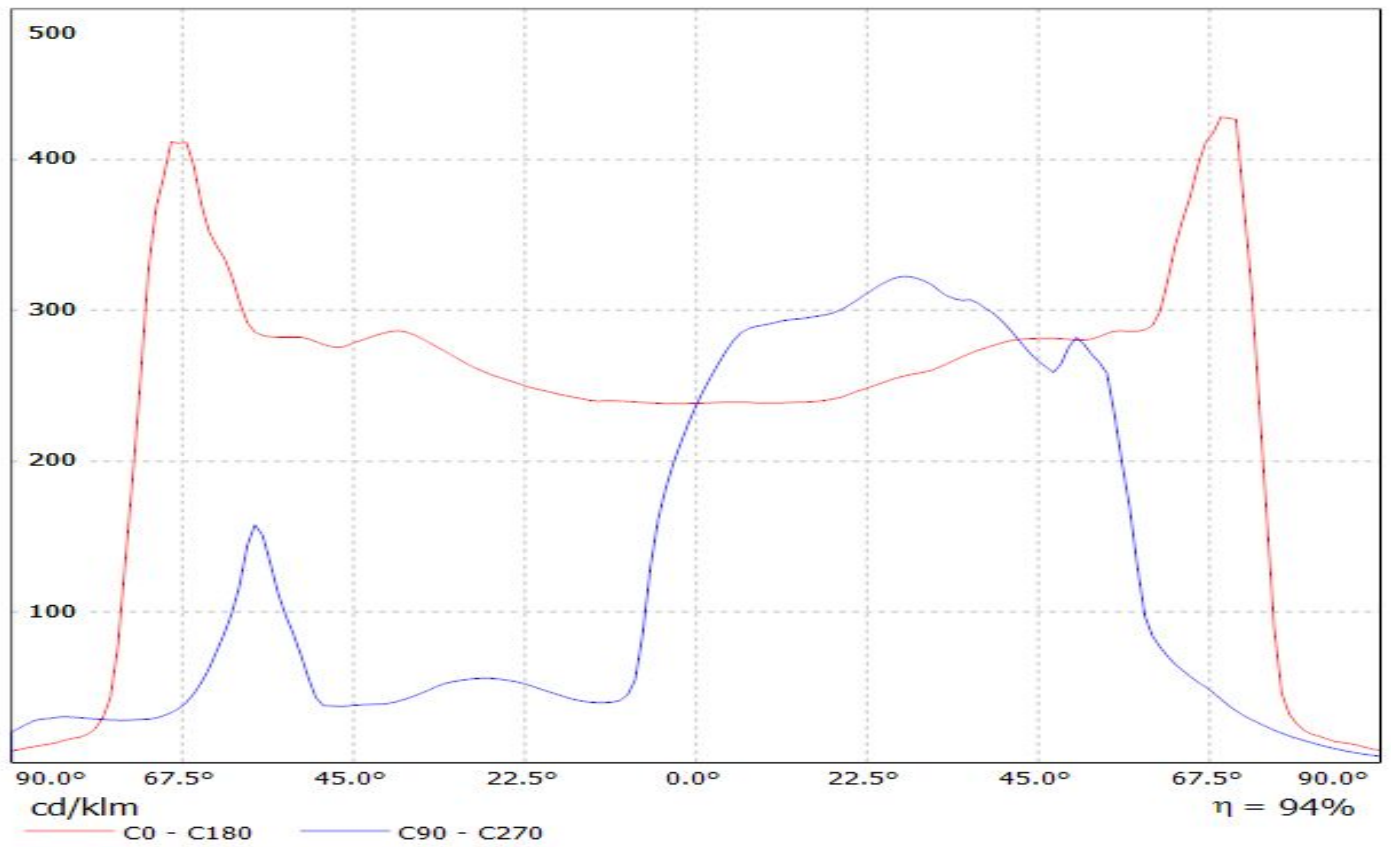

Luminaire: LEDiL Oy C13301_STRADA-2X2-T3_(Luxeon-Z-ES) Eff: 94%
Lamps: 1 x Luxeon Z ES 2x2 (LX22-3090) 209.277lm@250mA_P=2.81W_I=0.2499A

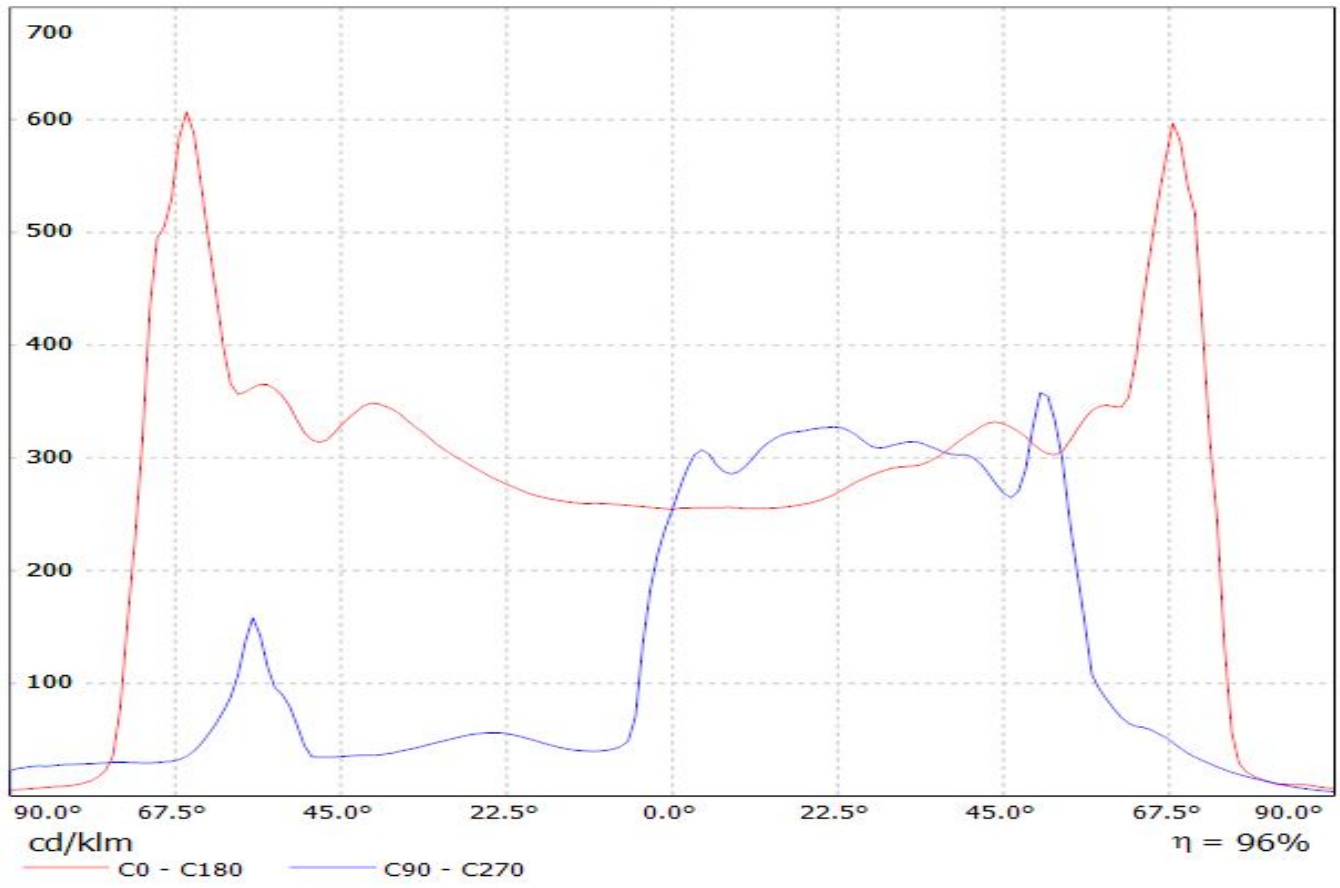

Luminaire: LEDiL Oy C13301_STRADA-2X2-T3_(LUXEON_Q)

Lamps: 1 x LUXEON_Q_2x2_(LHQ-3080)_299.038lm@250mA_P=2.8742W_I=249.8mA

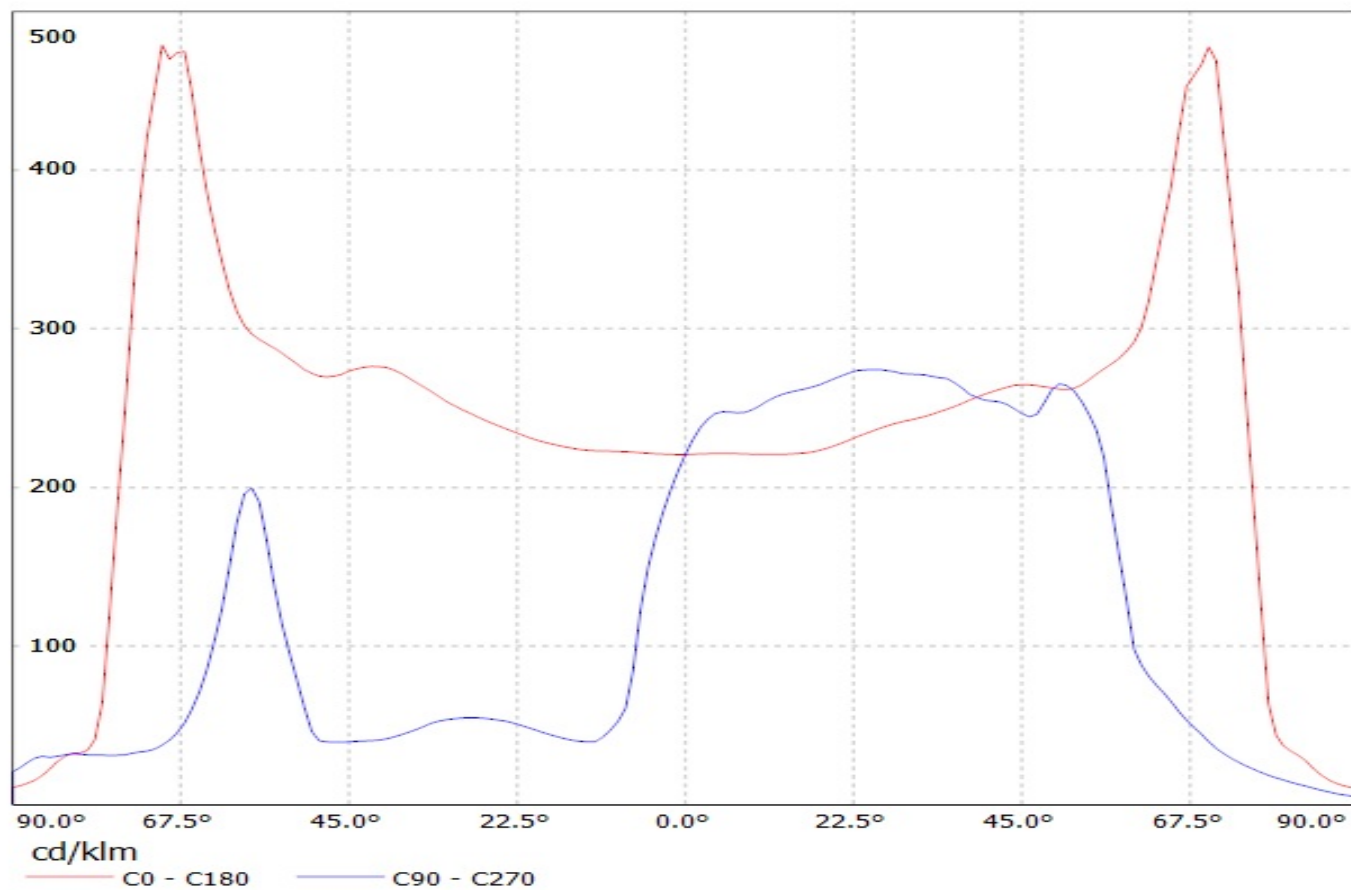

Luminaire: Ledil C13301_STRADA-2X2-T3_(Luxeon_MZ)

Lamps: 1 x Philips_Lumileds_Luxeon_MZ_(LMZ7-QW57)_(2x2)_427.268lm@250mA_P=2.734W_I=0.2500A

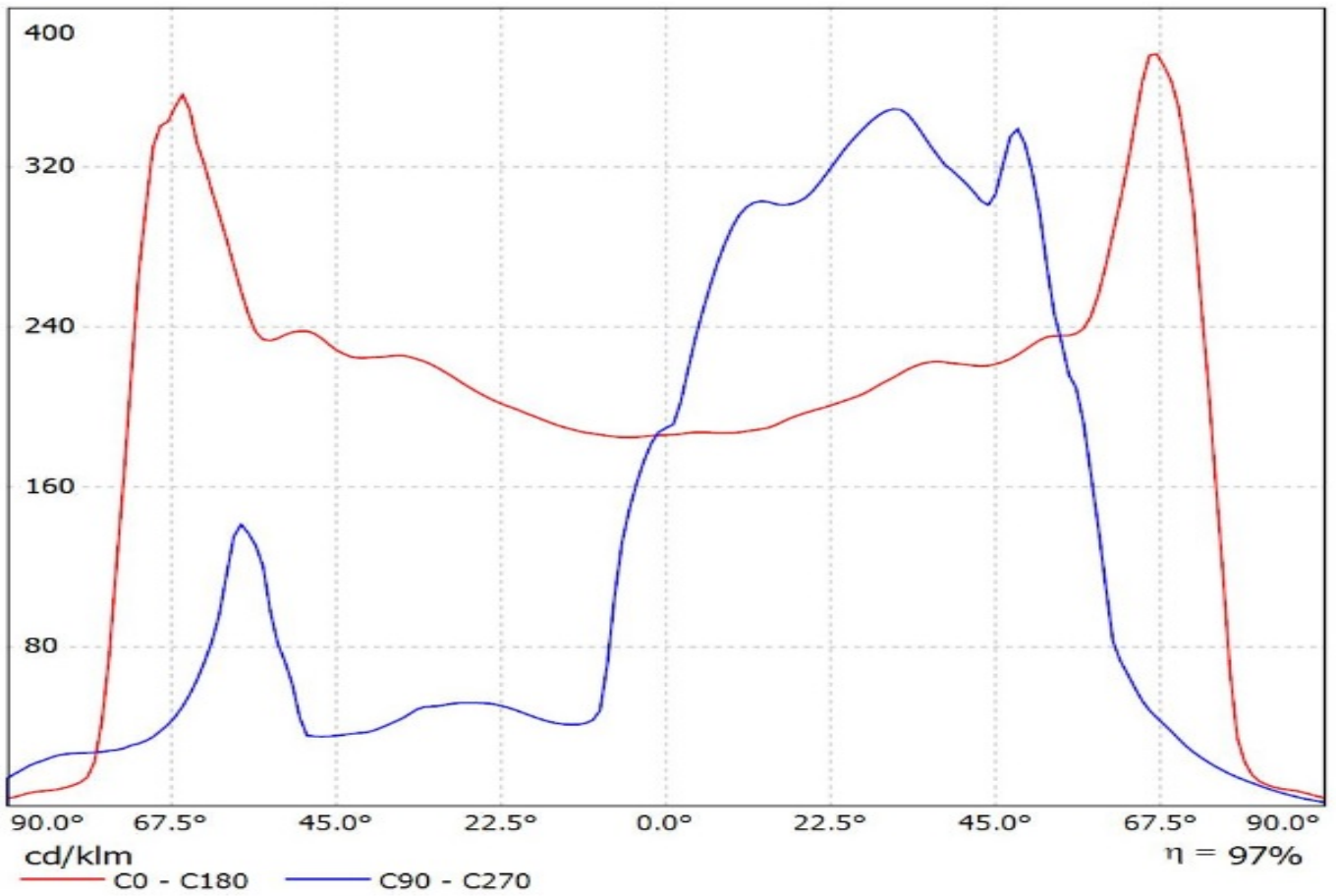

Luminaire: LEDiL Oy C13301_STRADA-2X2-T3_(Luxeon_TX)
Lamps: 1 x Luxeon_TX_2x2_321.384lm@250mA_P=2.79488W_I=249.9mA

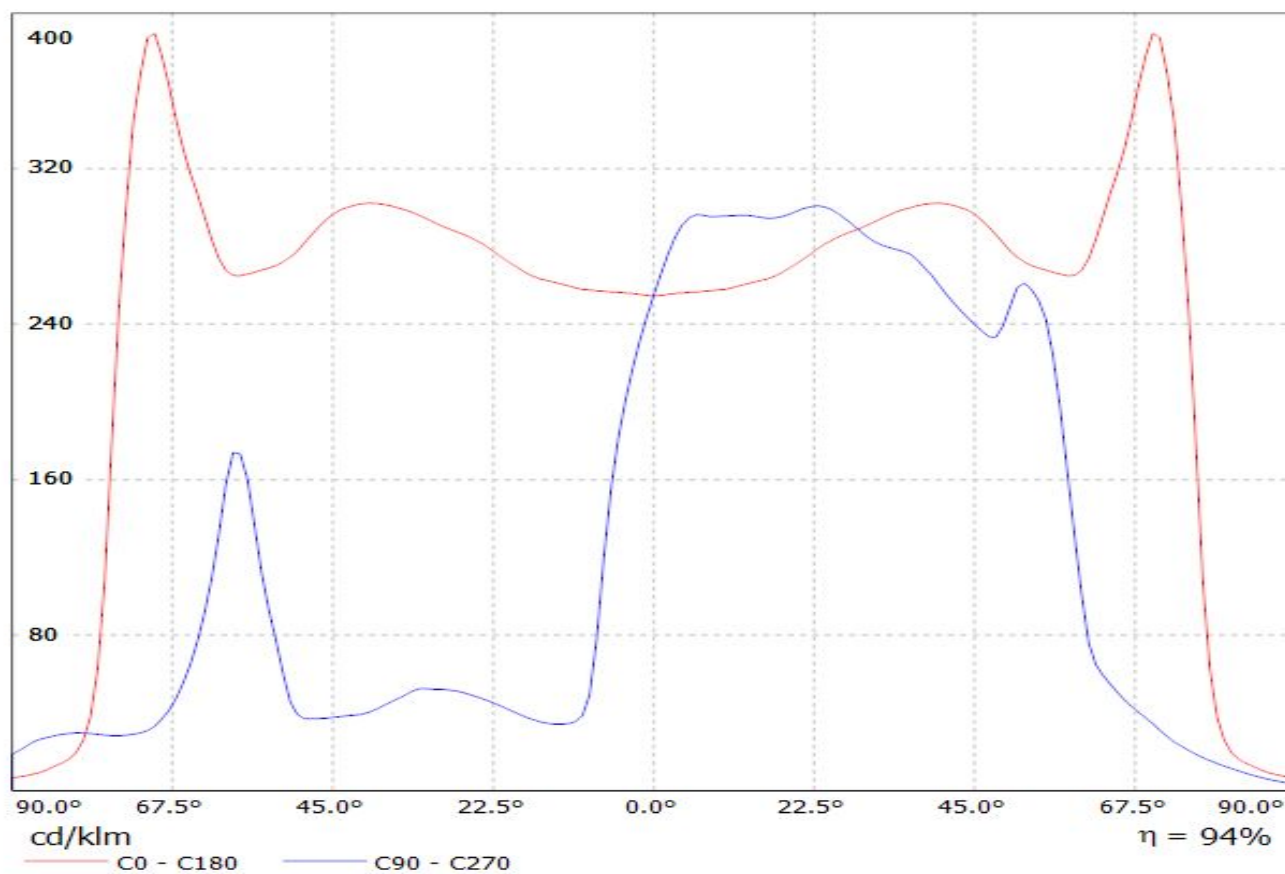

Luminaire: LEDiL Oy C13301_STRADA-2X2-T3_(Luxeon_5050)

Lamps: 1 x Luxeon_5050_2x2_1270.76lm@80mA_CCT=5700K_P=7.35815W_I=0.080A_70CRI

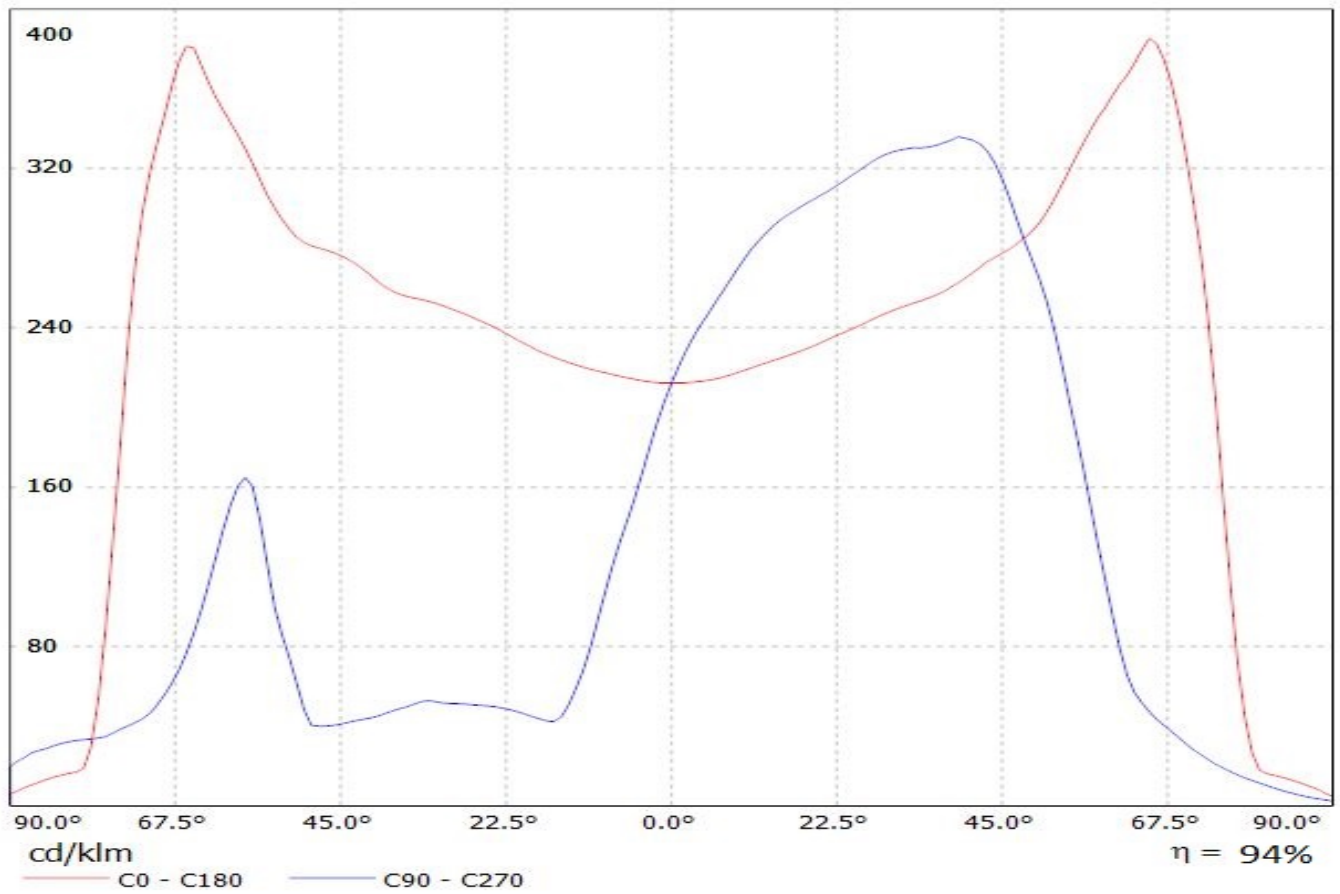

Luminaire: LEDiL Oy C13301_STRADA-2X2-T3_(Luxeon_V)

Lamps: 1 x Lumileds_Luxeon_V_488.501lm@250mA_CCT=4000K_P=2.75155W_I=0.250A

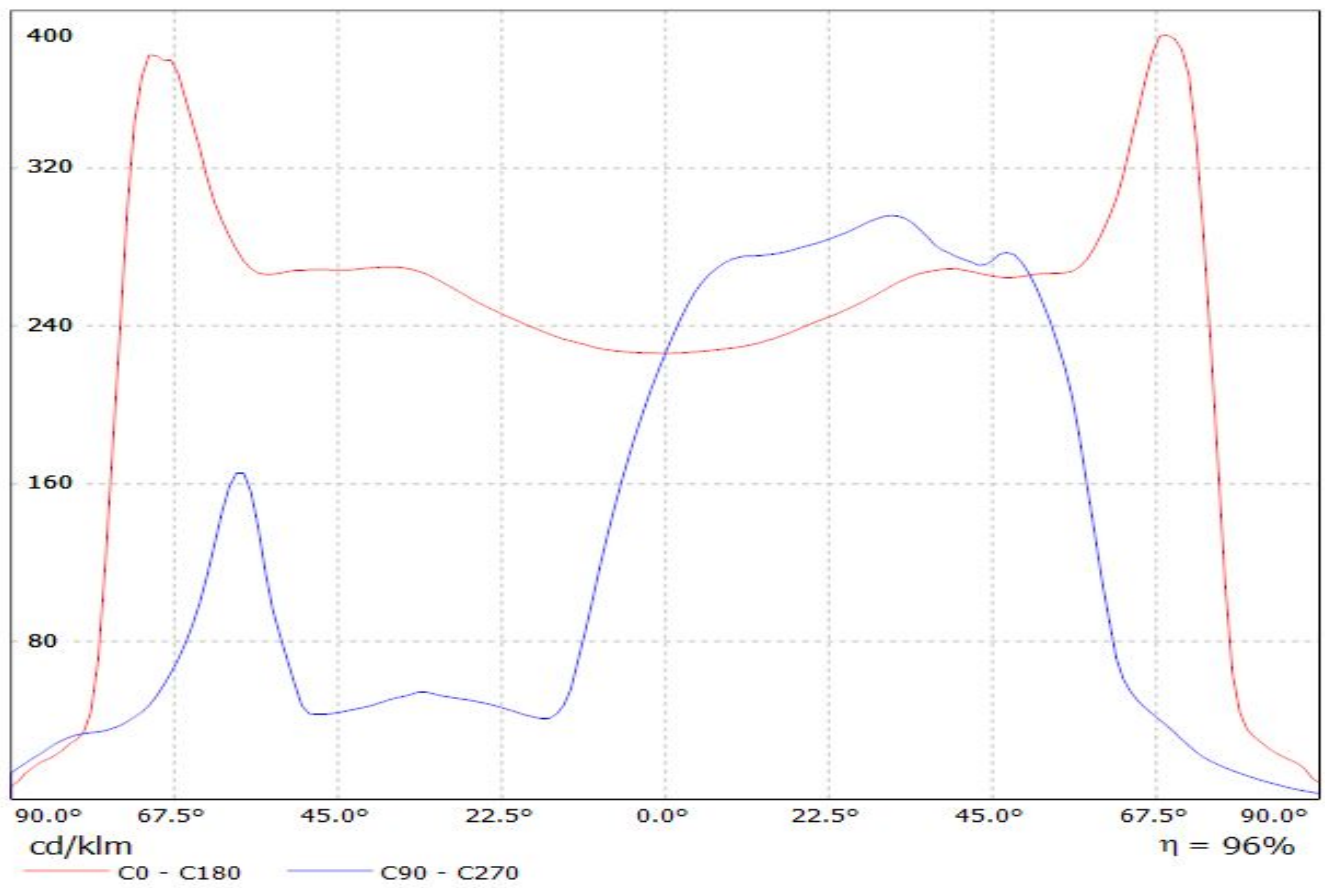

LEDiL Oy C13301_STRADA-2X2-T3_(Nichia_219B) Eff.94.4% / LDC (Linear)

Luminaire: LEDiL Oy C13301_STRADA-2X2-T3_(Nichia_219B) Eff.94.4%
Lamps: 1 x Nichia_219B (310lm@250mA)

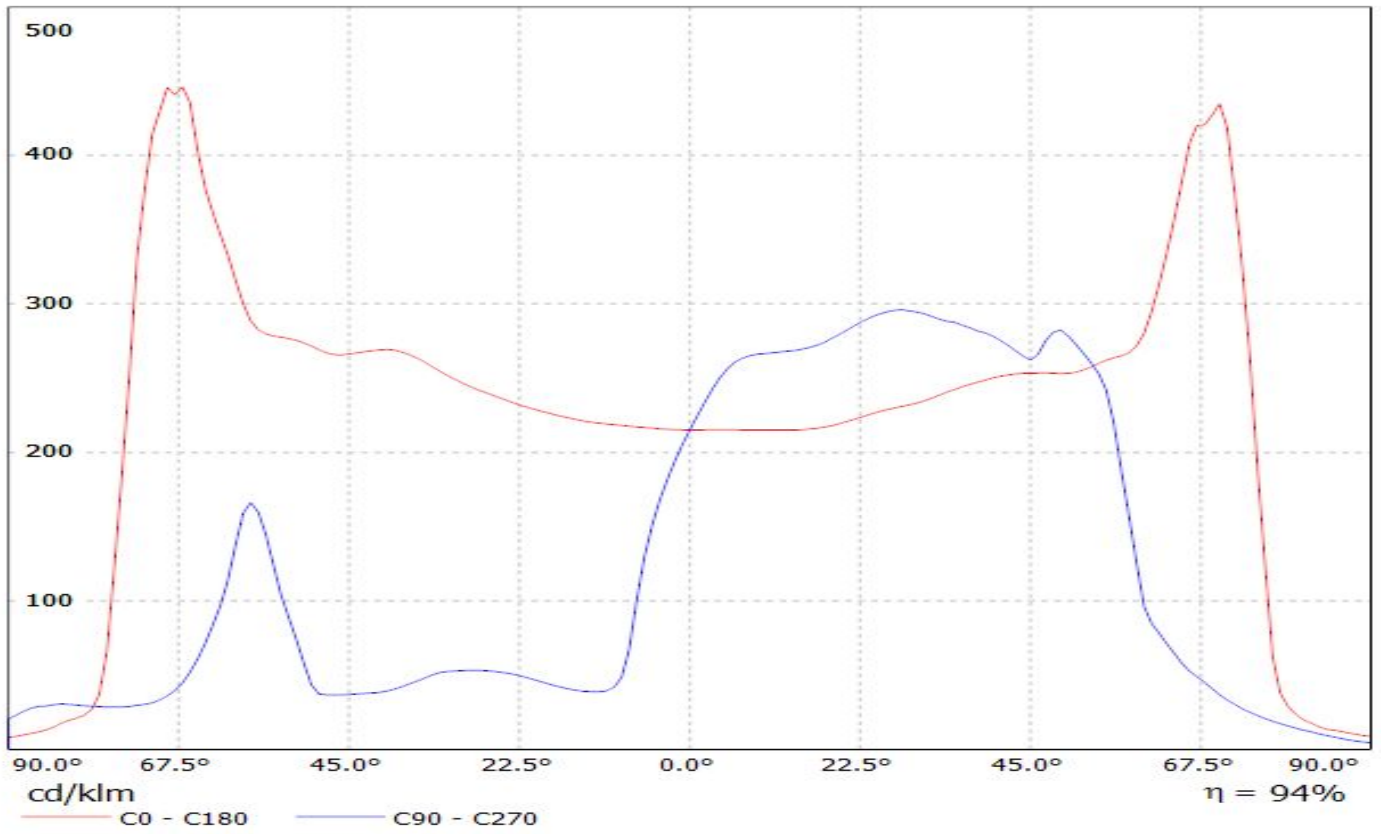

LEDiL Oy C13301_STRADA-2x2-T3_(N383) Eff.95.9% / LDC (Linear)

Luminaire: LEDiL Oy C13301_STRADA-2x2-T3_(N383) Eff.95.9%
Lamps: 1 x NICHIA_NS9x383 (287.074lm@250mA)

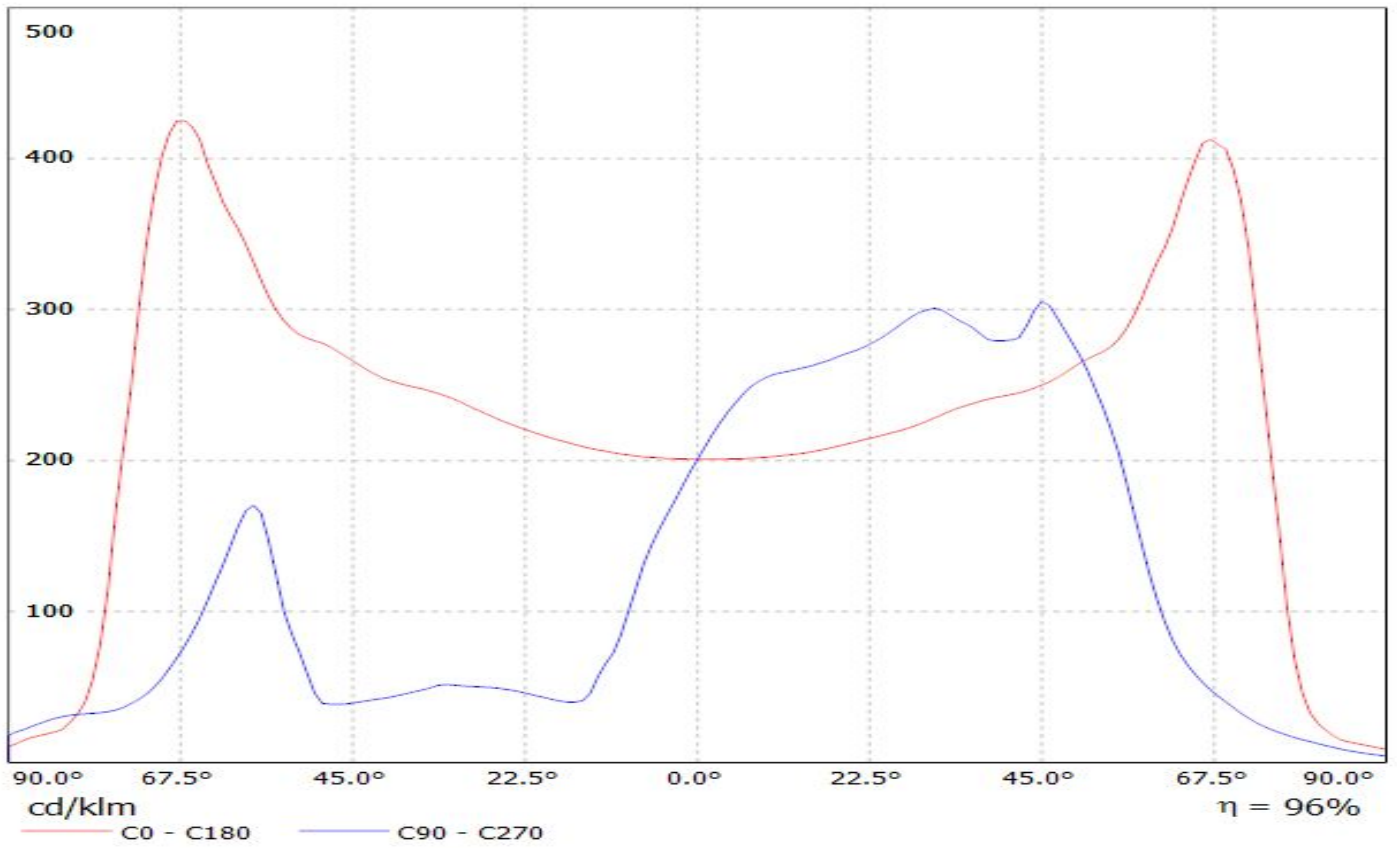

Luminaire: LEDiL Oy C13301_STRADA-2X2-T3_(NWSL229AE)

Lamps: 1 x Nichia_2X2_NWSL229AE_476.548lm@250mA_P=2.7515W_I=0.250A

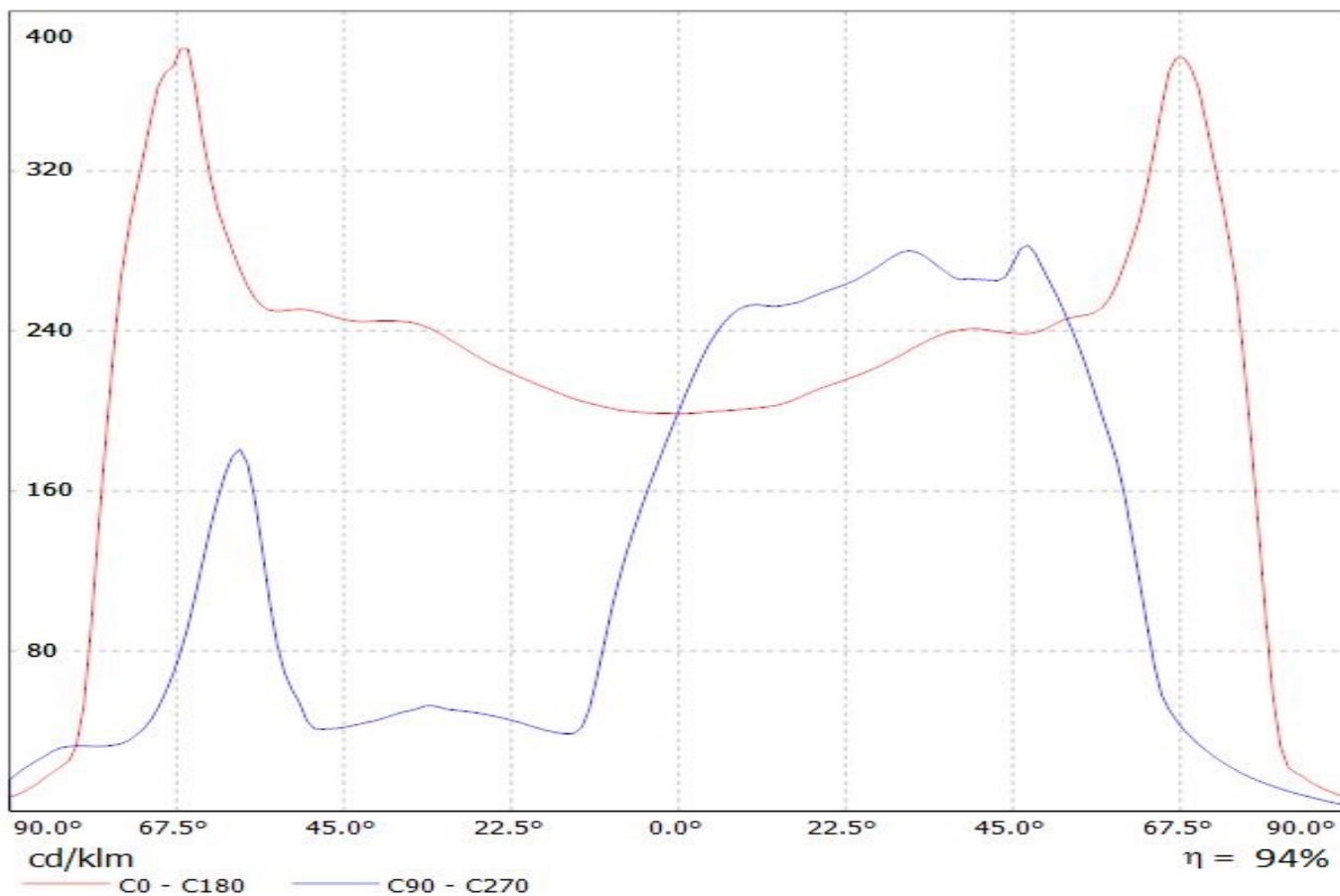

Luminaire: Ledil C13301_STRADA-2X2-T3_(NVSW319AE)
Lamps: 1 x Nichia_NVSW319AE_(sm405D440f2L2R70)

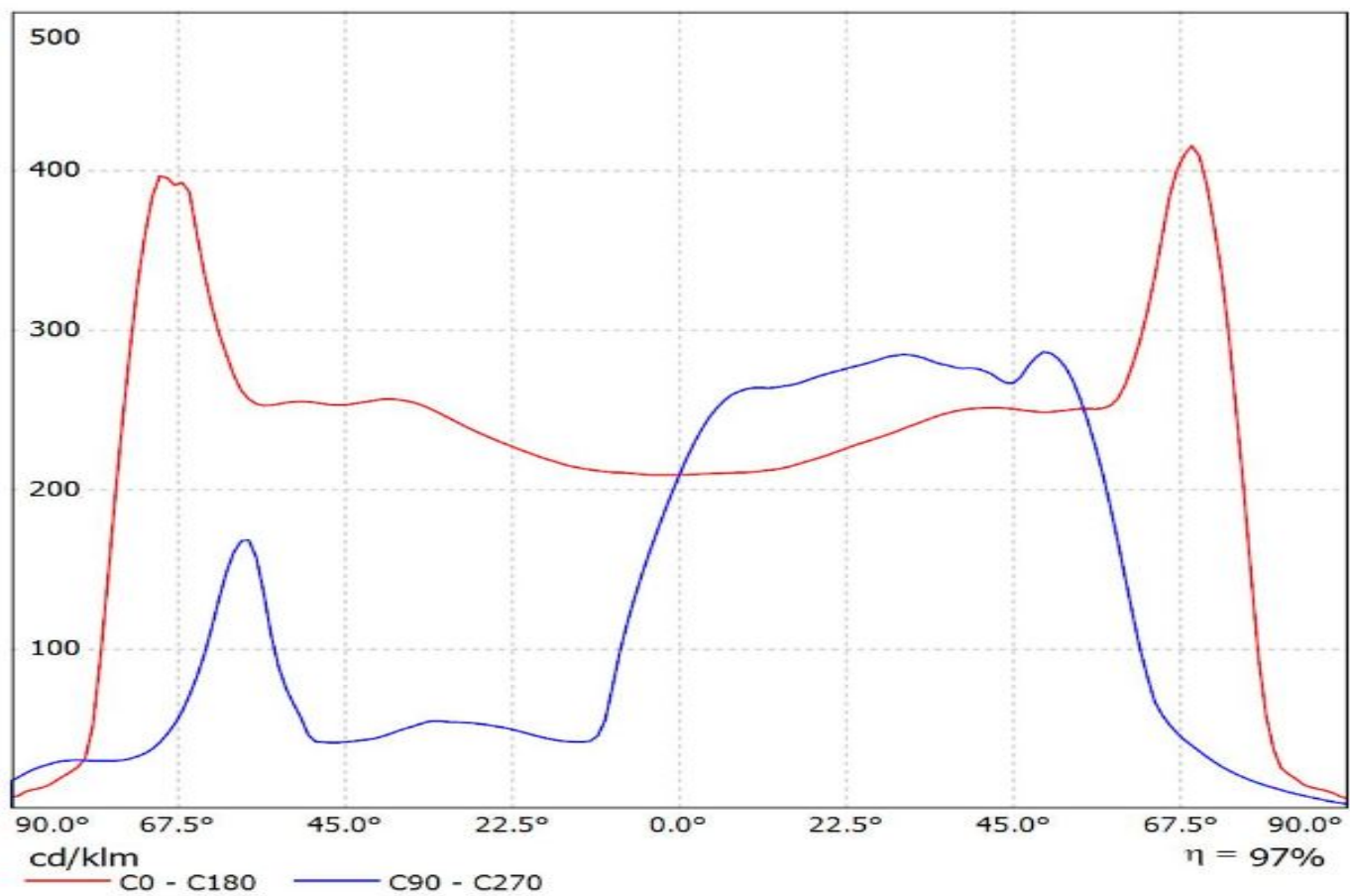

Luminaire: LEDiL Oy C13301_STRADA-2X2-T3_(E21A)
Lamps: 1 x Nichia_E21A_2x2_451.527lm@250mA_P=2.8055W_I=0.250A

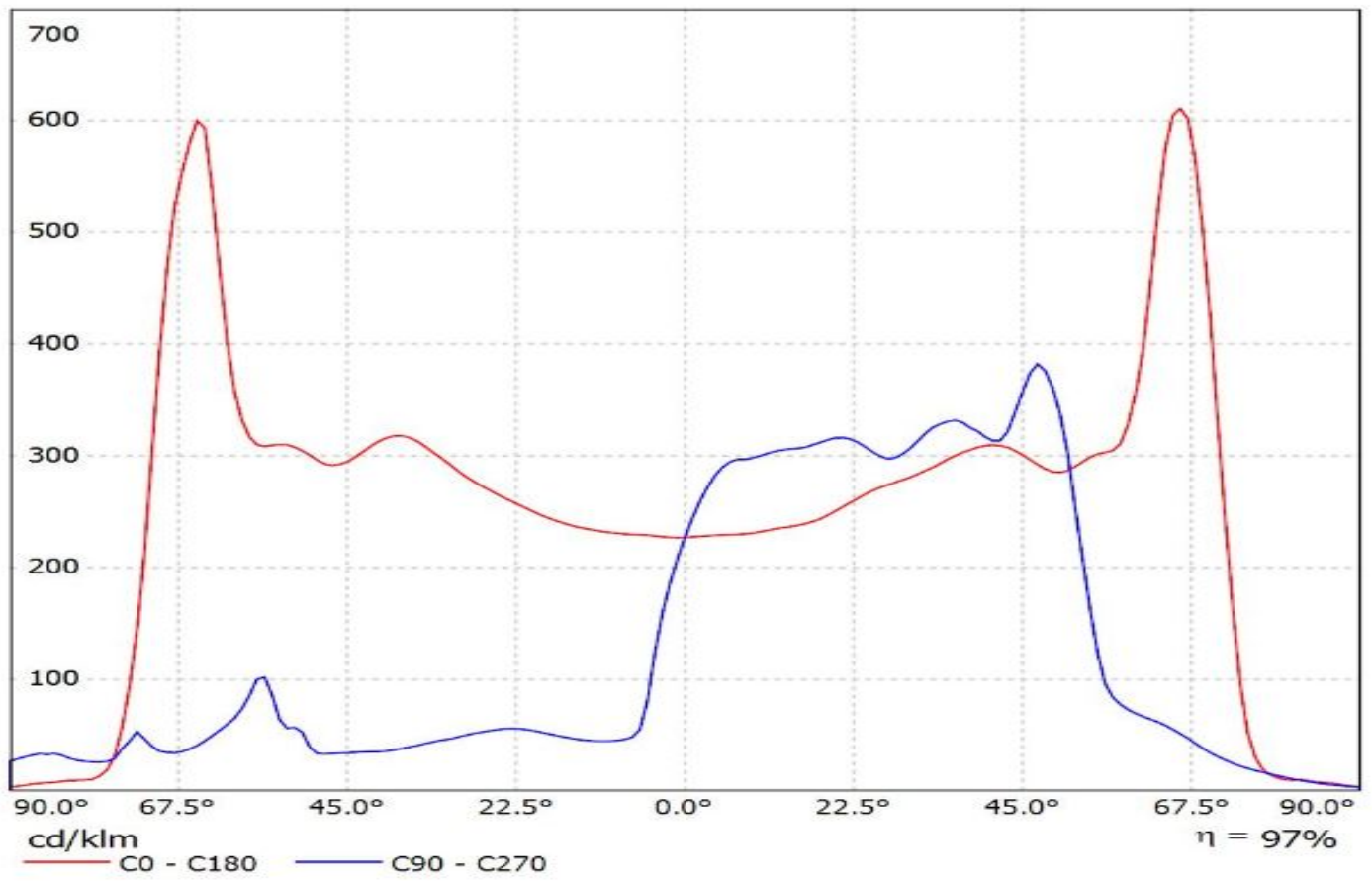

Luminaire: Ledil C13301_STRADA-2X2-T3_(NVSxx19C)

Lamps: 1 x NICHIA_NV5xx19C_2x2_(NVSL219CE)_417.172lm@250mA_P=2.8W_I=0.25A

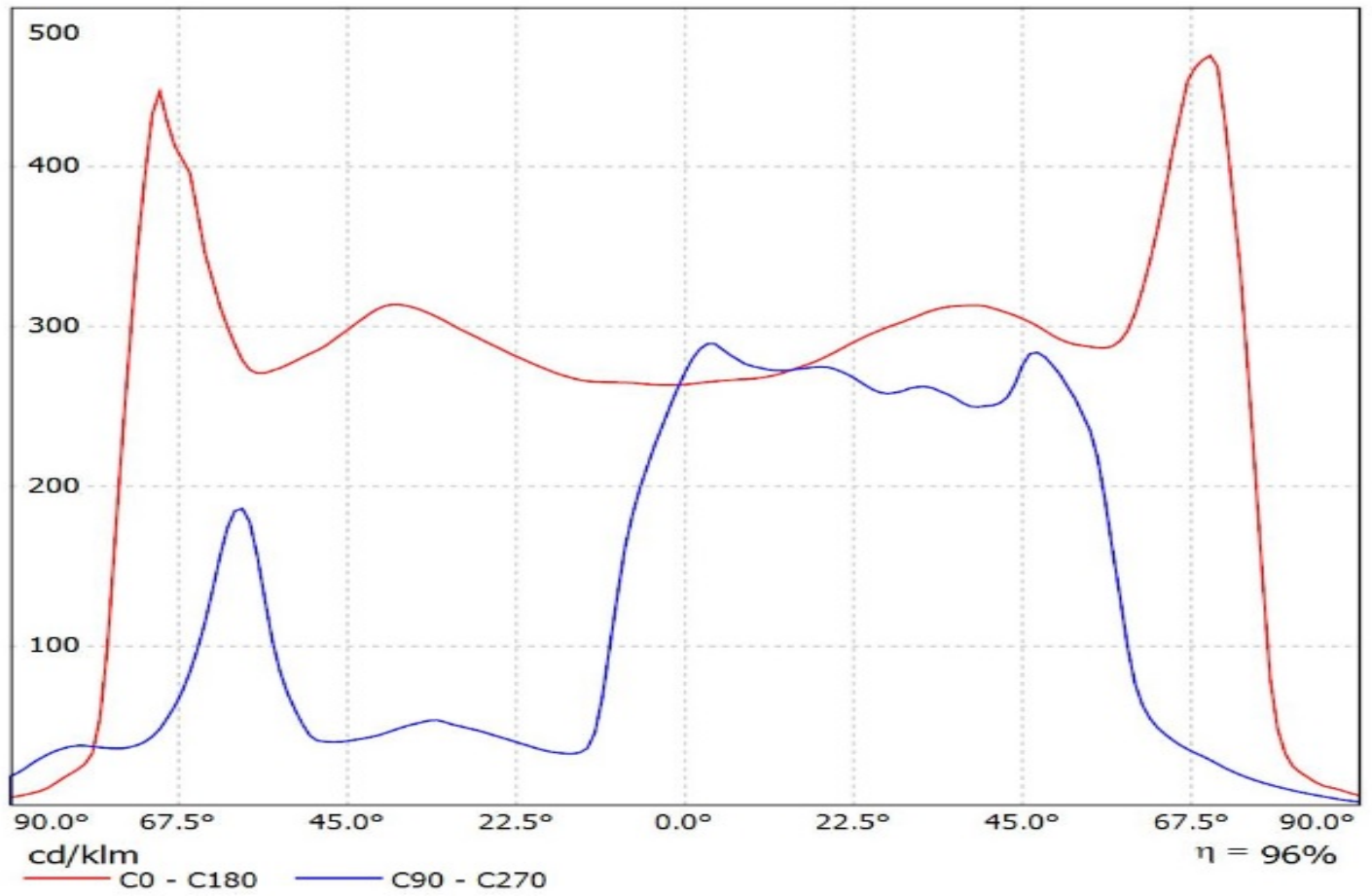

Luminaire: LEDiL Oy C13301_STRADA-2X2-T3 (NVSW219D)
Lamps: 1 x Nichia_NVSW219D_516.635lm@250mA_P=2.82399W_CCT=4000K_I=0.250A

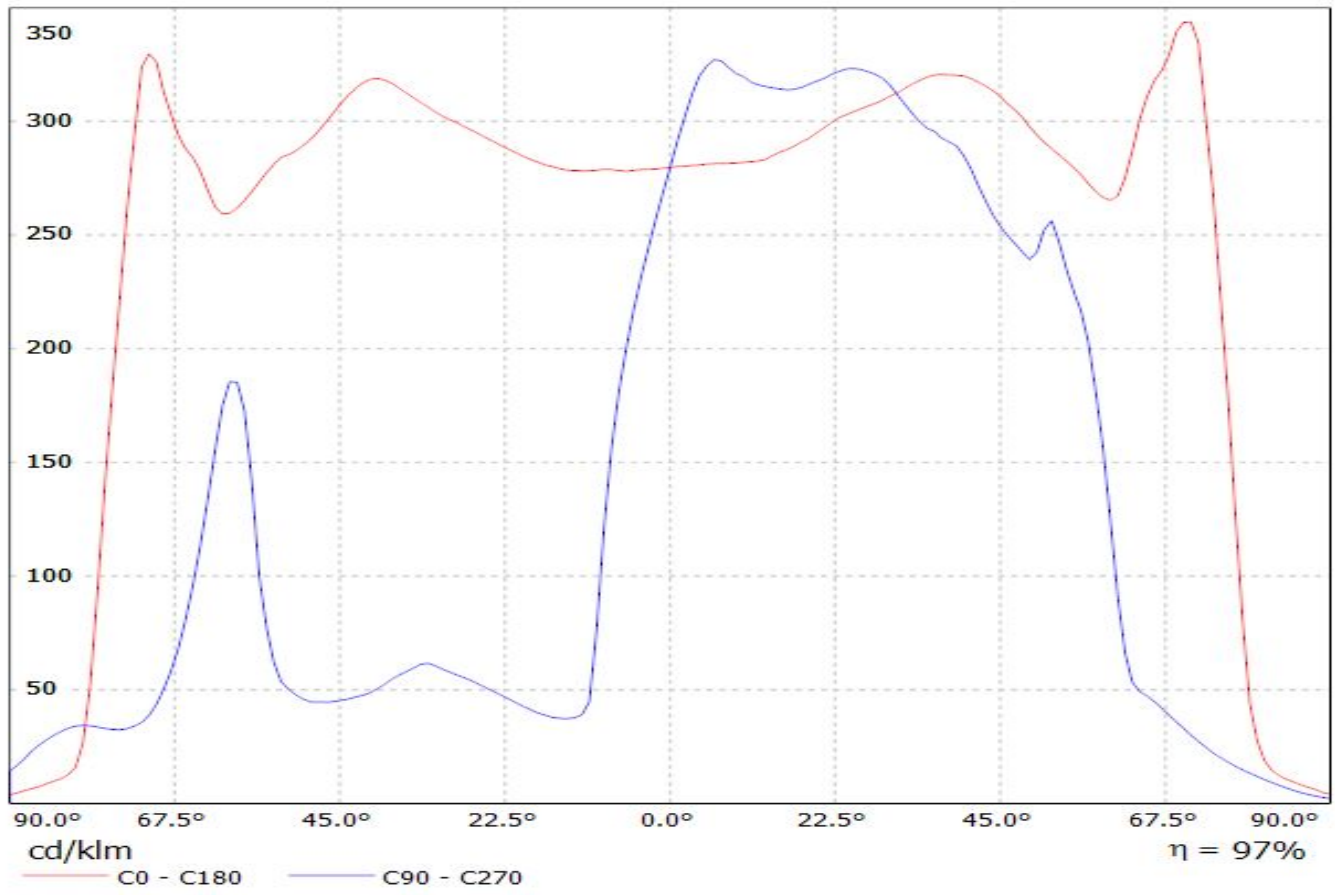

LEDiL Oy C13301_STRADA-2X2-T3_(SQ-PC) Eff.94.3% / LDC (Linear)

Luminaire: LEDiL Oy C13301_STRADA-2X2-T3_(SQ-PC) Eff.94.3%

Lamps: 1 x Oslon Square PC (399lm@250mA)

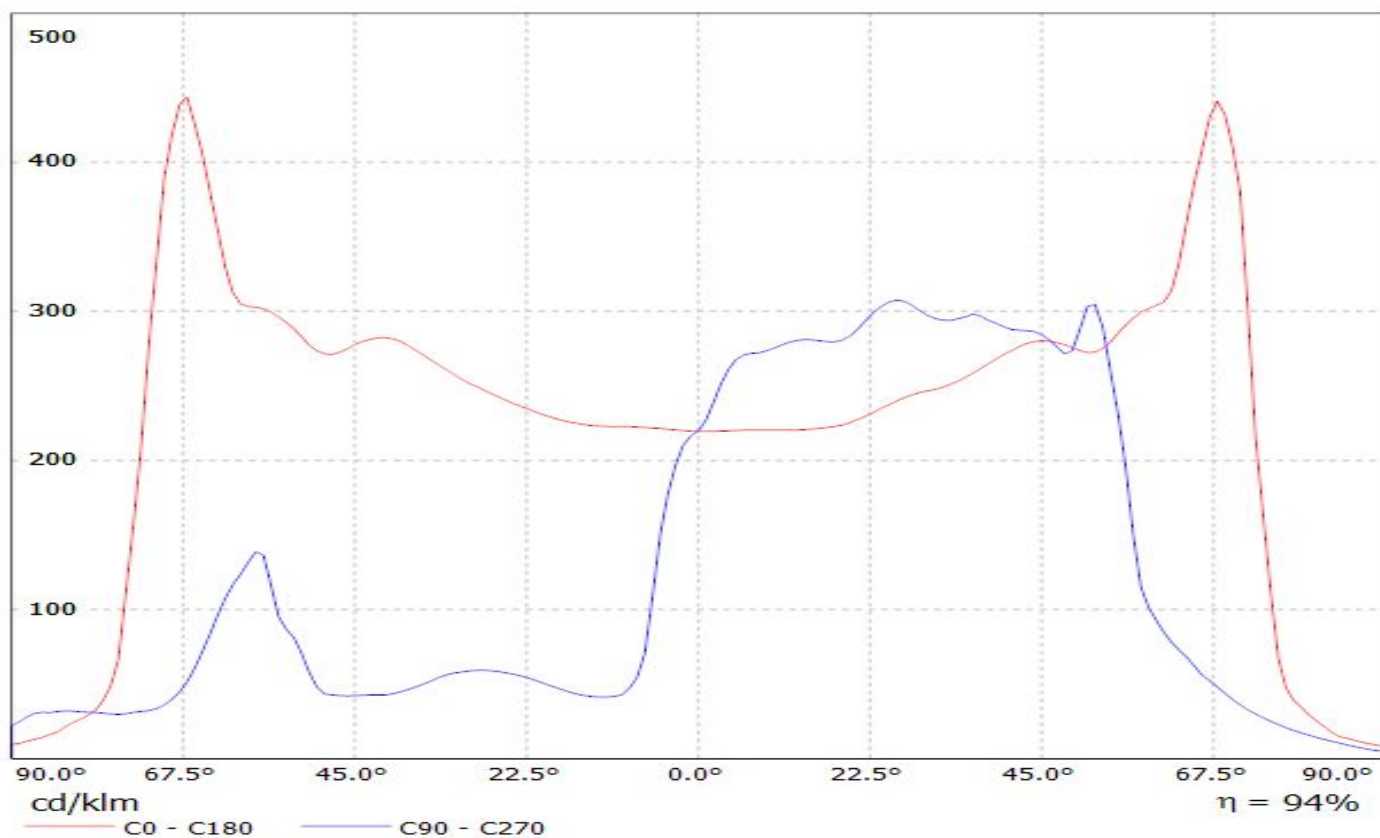

Luminaire: Ledil Oy C13301STRADA-2X2-T3_(Duris_S8_Gen2)_SIMULATED
Lamps: 1 x OSRAM_DURIS S8 GEN2 5050 package

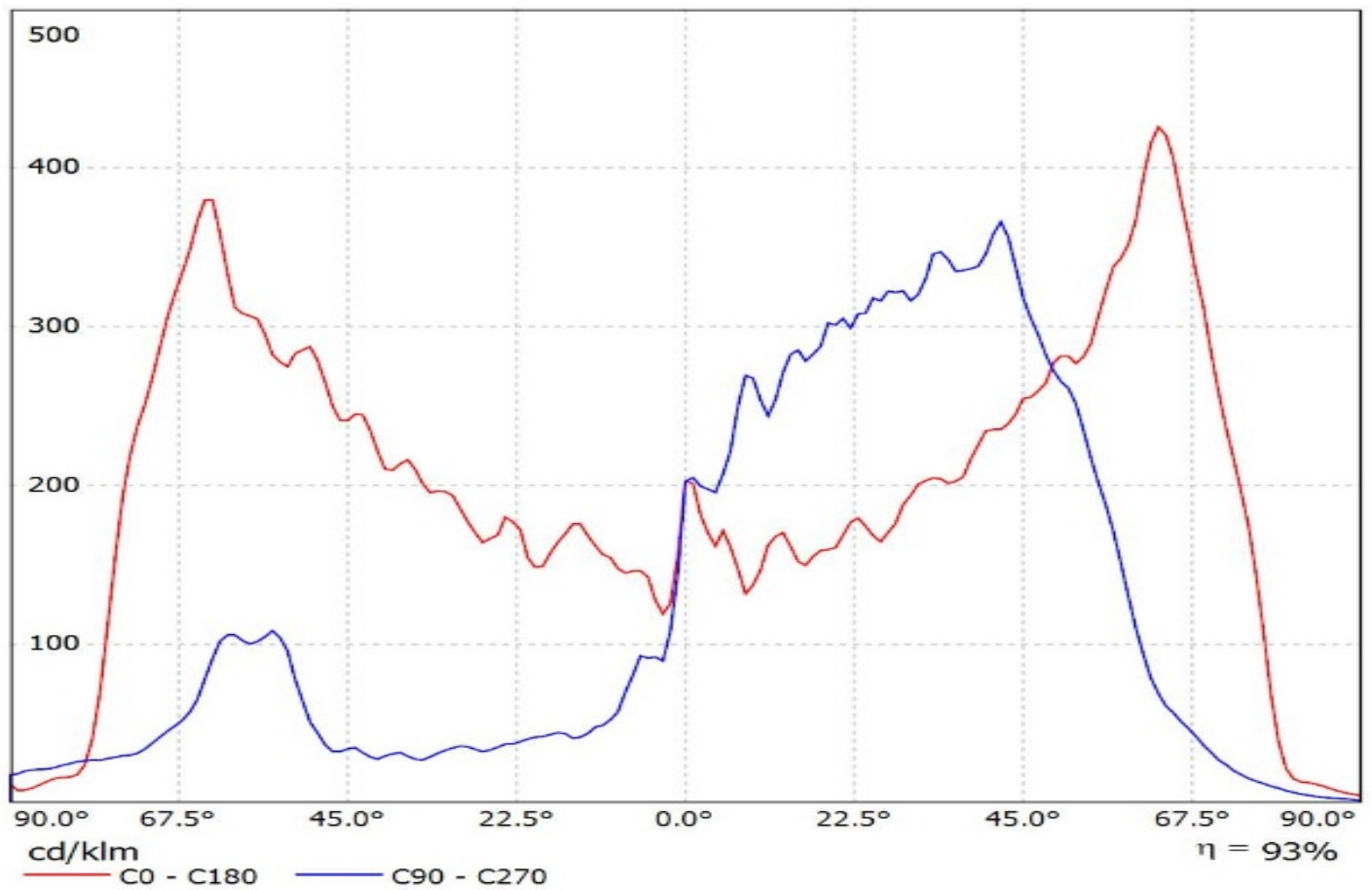

Luminaire: Ledil Oy C13301_STRADA-2X2-T3_(Duris_P8)_SIMULATED
Lamps: 1 x Osram Duris P8

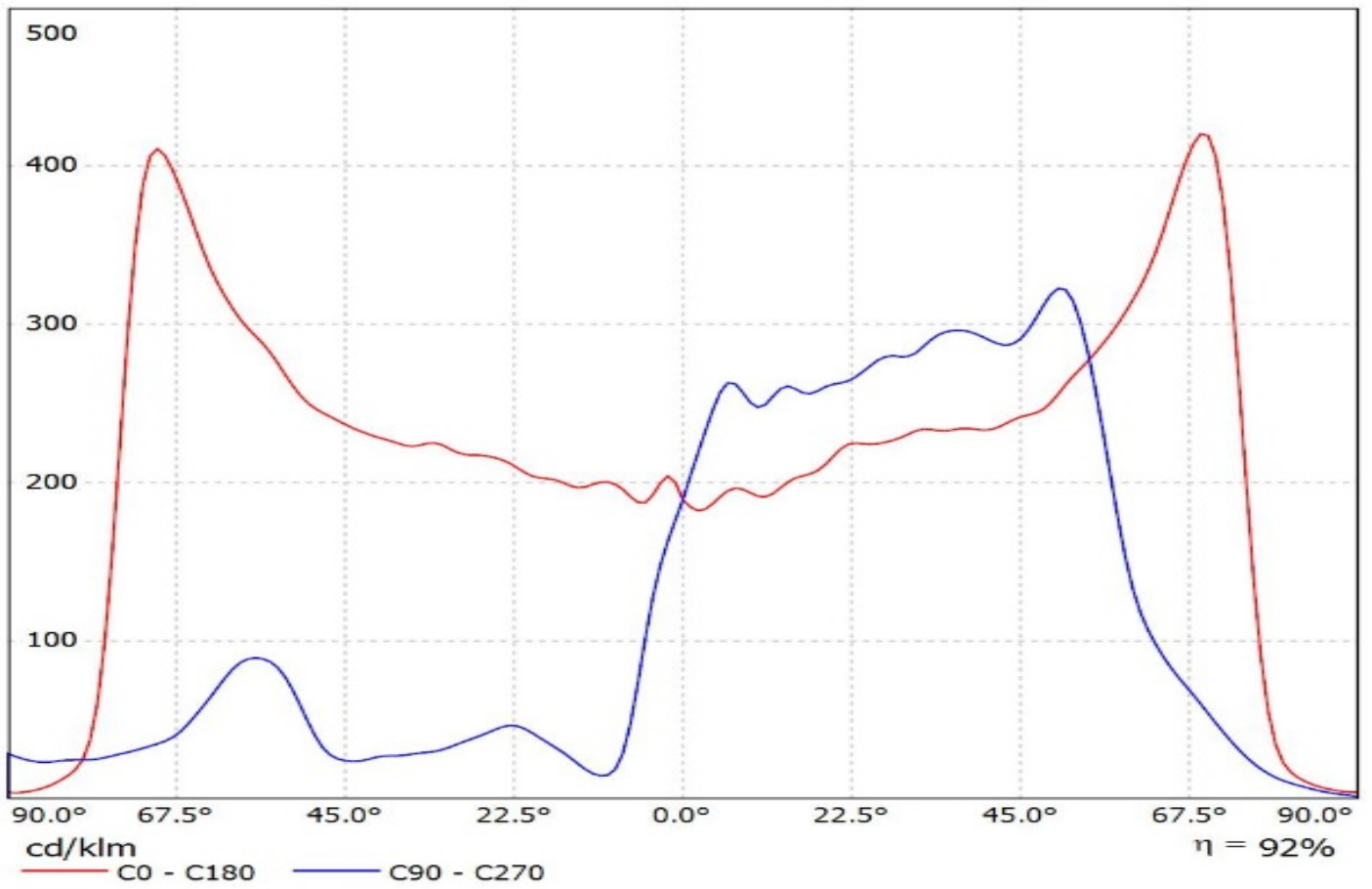

Luminaire: Ledil Oy C13301_STRADA-2X2-T3_OSRAM_DURIS_P9_SIMULATED
Lamps: 1 x OSRAM DURIS P9

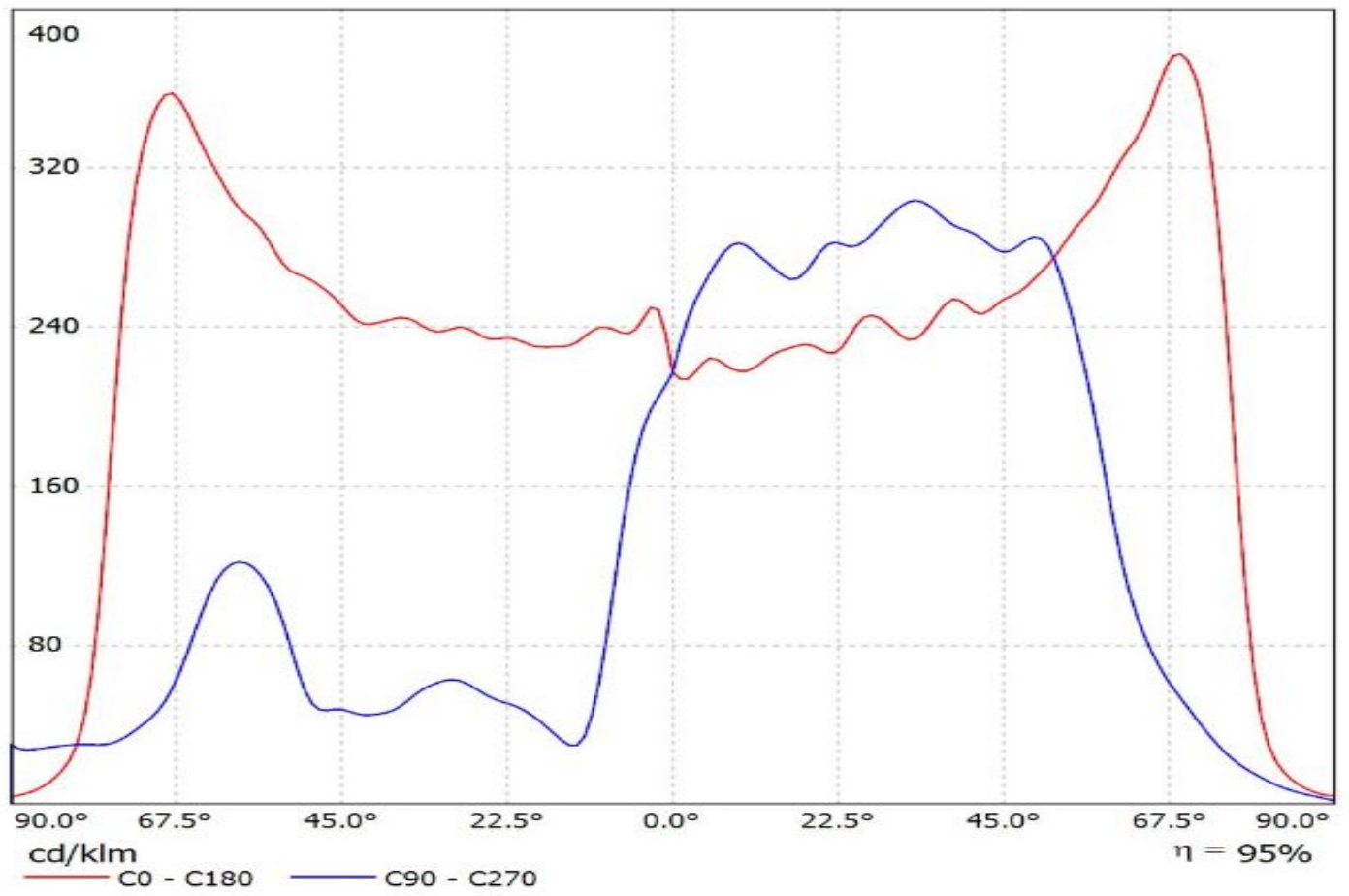

LEDiL Oy C13301_STRADA-2X2-T3_(SSL80) Eff.95.0% / LDC (Linear)

Luminaire: LEDiL Oy C13301_STRADA-2X2-T3_(SSL80) Eff.95.0%

Lamps: 1 x Oslon_SSL80 (311lm@250mA)

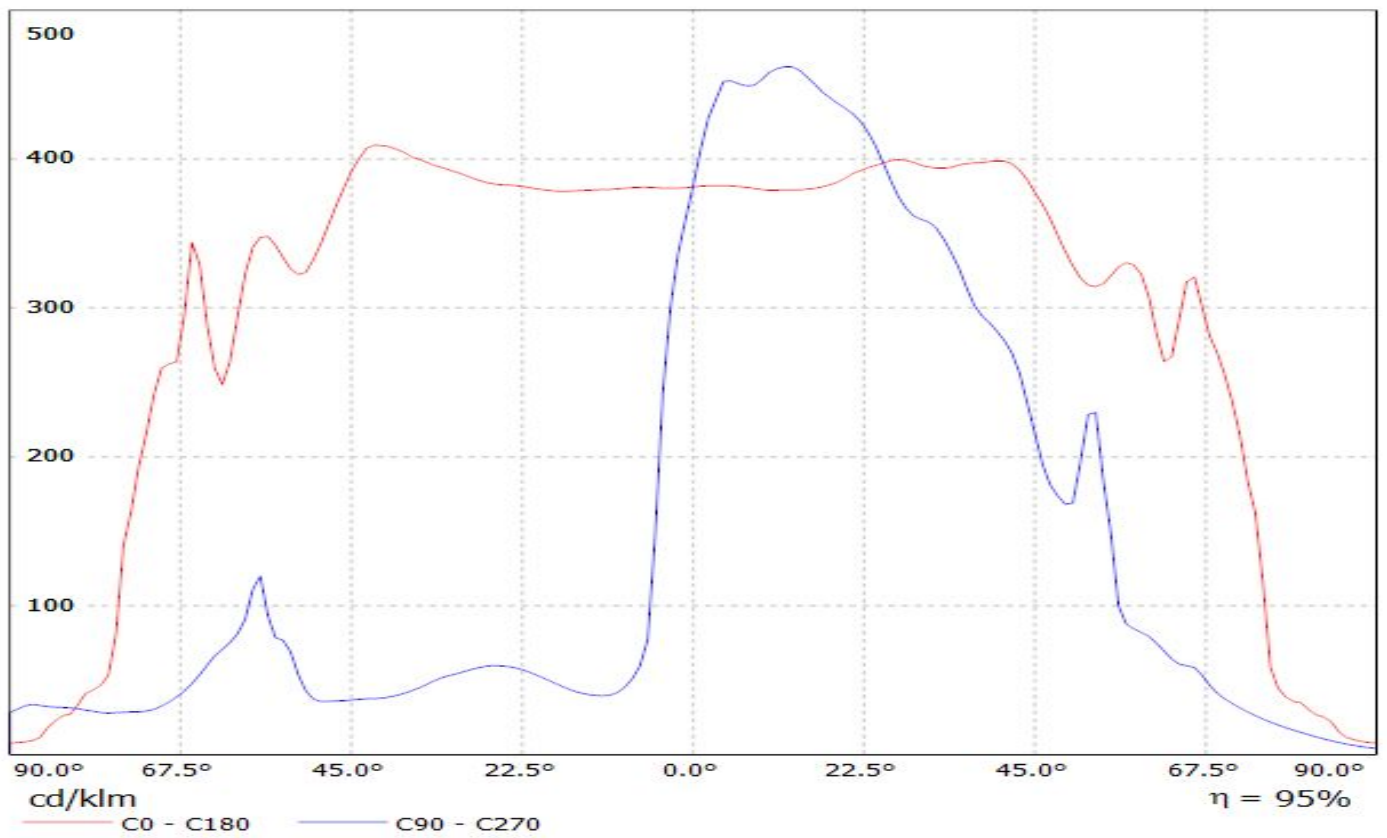

Luminaire: LEDiL Oy C13301_STRADA-2X2-T3_(Fortimo_F-Flex_2x8_740DAG3)

Lamps: 1 x Philips_Fortimo_F-Flex_2x8_740DAG3_1786.86lm@250mA_P=11.6092W_I=0.2498A

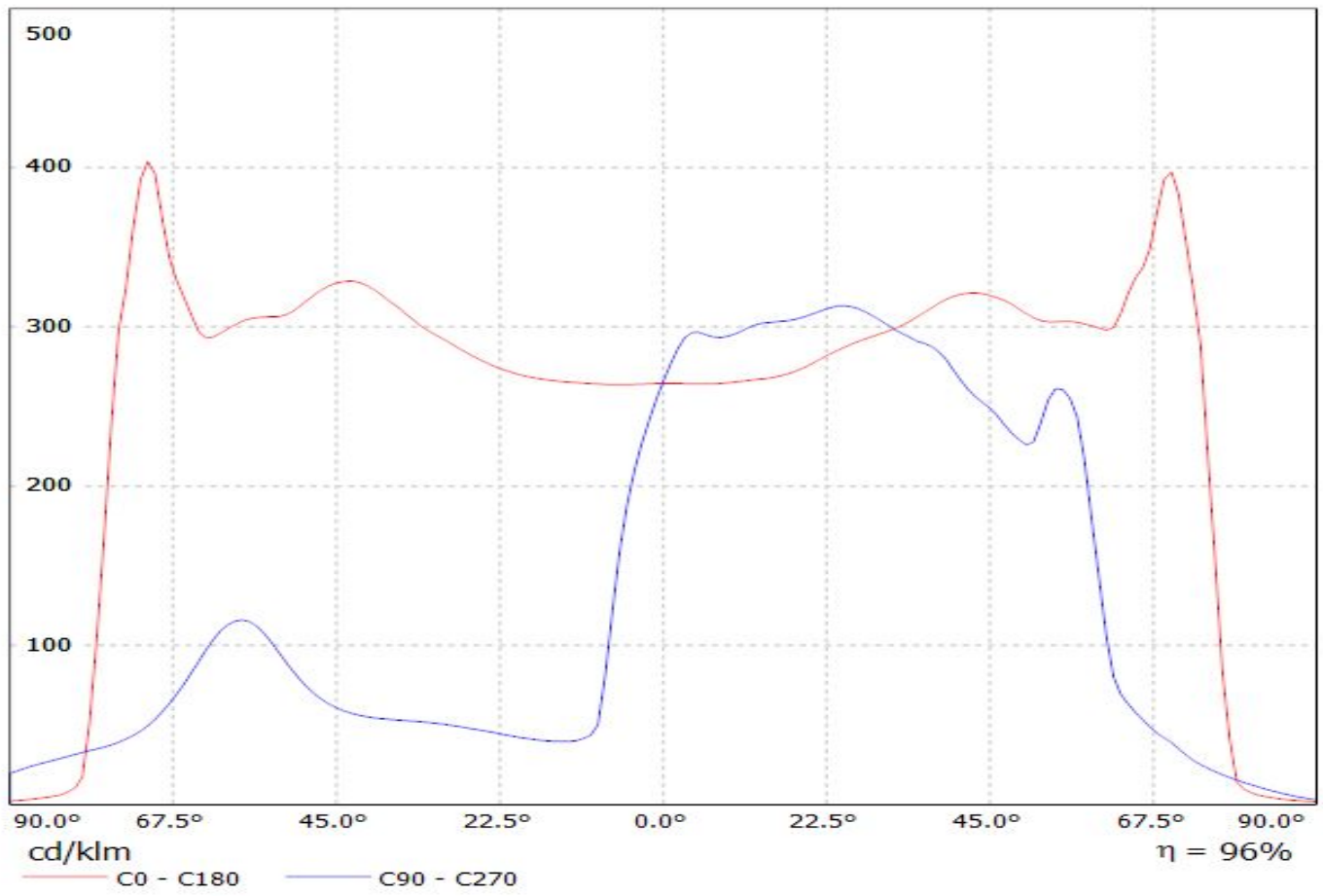

Luminaire: Ledil Oy Luminaire Catalog Number C13301_STRADA-2X2-T3_(Fortimo FastFlex LED board 2x8 DAX G4)_SIMULATED
Lamps: 1 x Fortimo FastFlex LED board 2x8 DAX G4

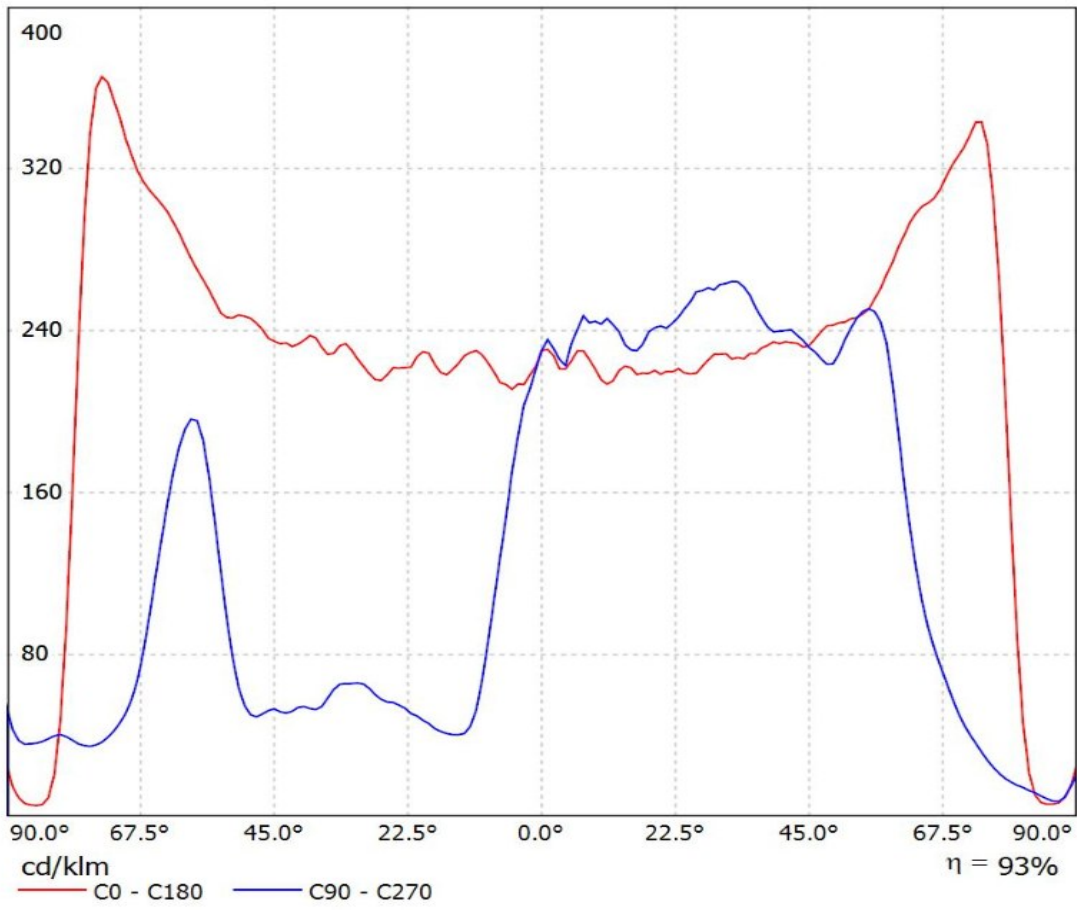

LEDiL Oy C13301_STRADA-2X2-T3_(3535) Eff.94.0% / LDC (Linear)

Luminaire: LEDiL Oy C13301_STRADA-2X2-T3_(3535) Eff.94.0%
Lamps: 1 x Samsung_3535 (343lm@250mA)

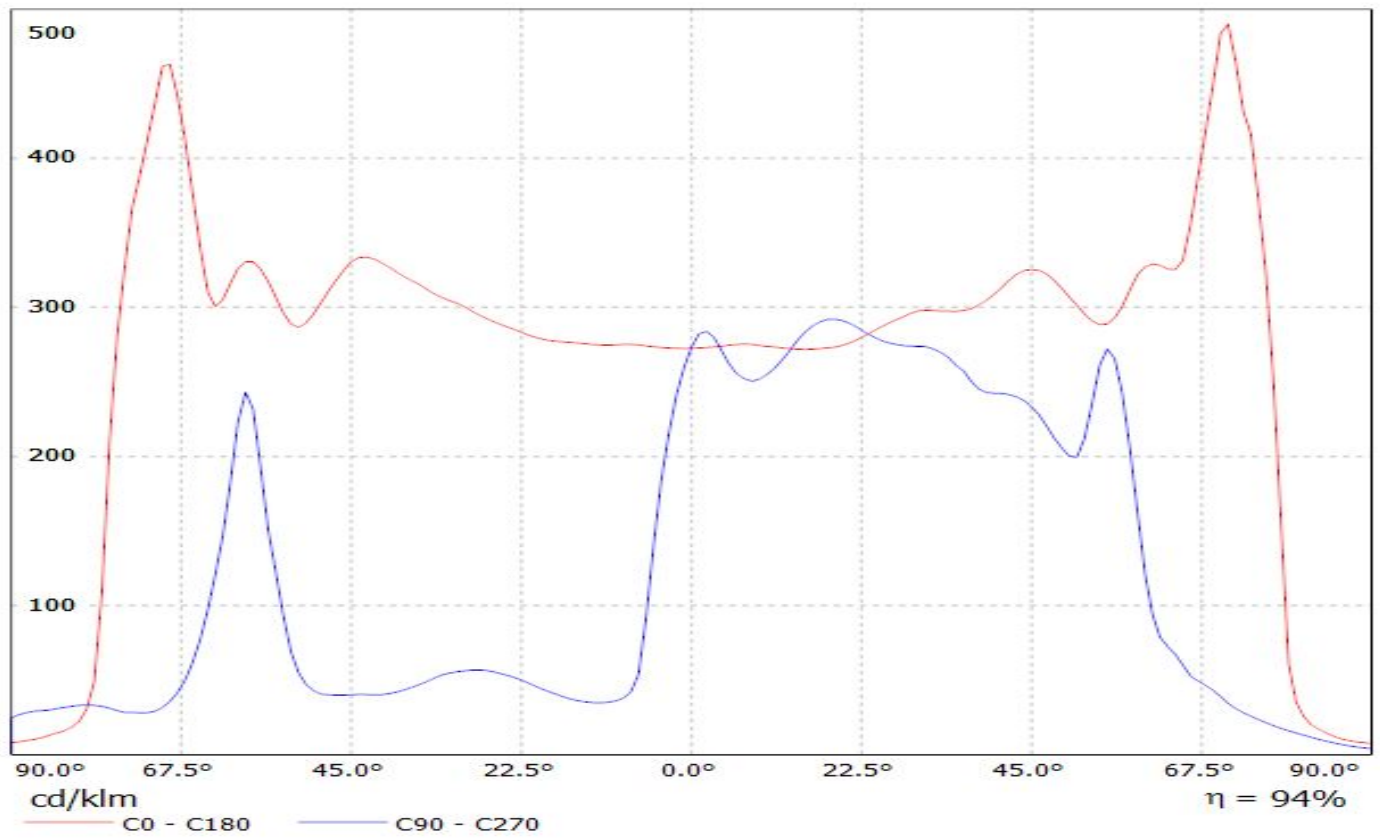

Luminaire: LEDiL Oy C13301_STRADA-2X2-T3_(LH351B)

Lamps: 1 x SAMSUNG_LH351B_2x2_442.67lm@250mA_P=2.84311W_I=249.9mA

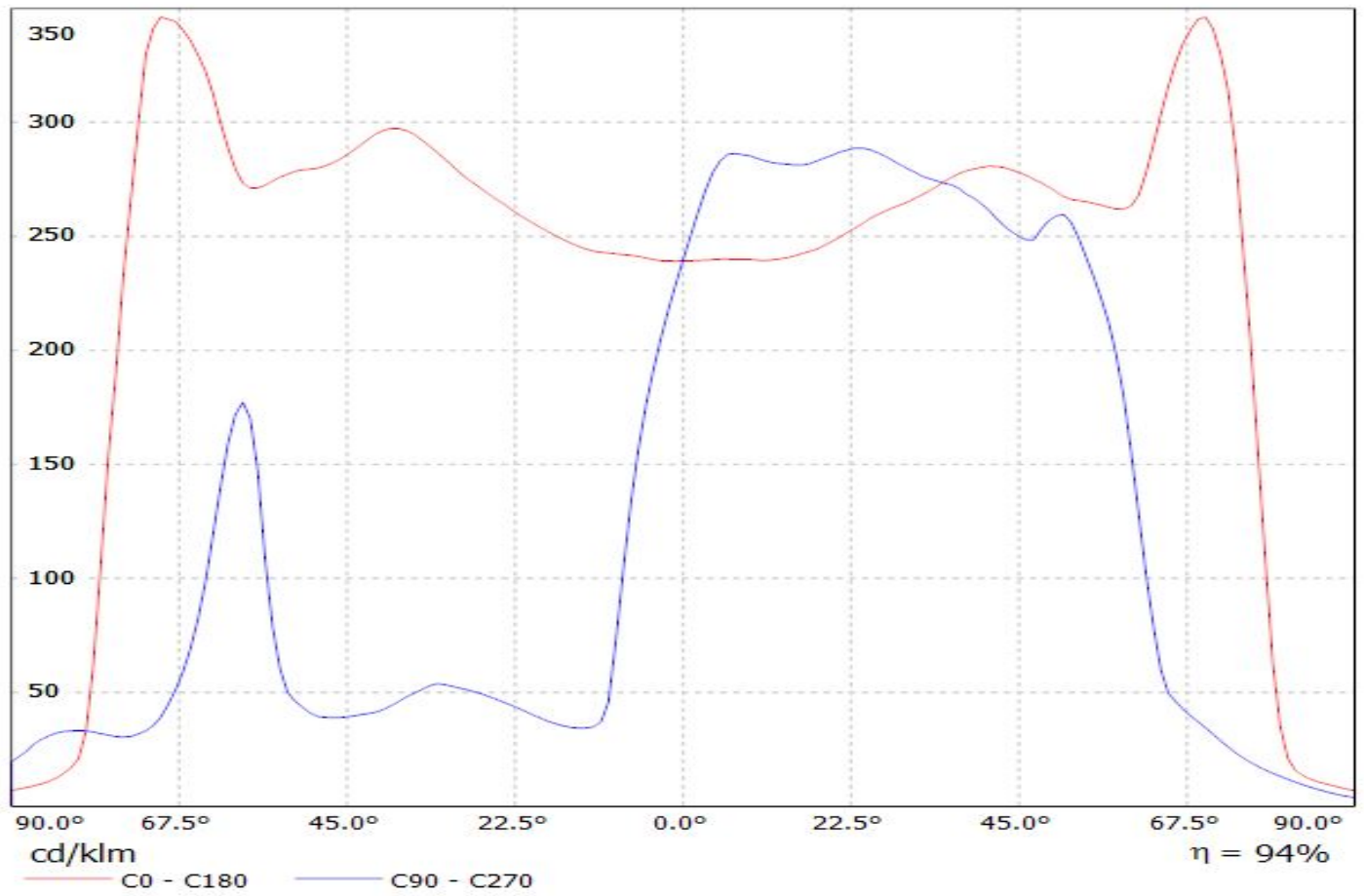

Luminaire: LEDiL Oy C13301_STRADA-2X2-T3_(LH351Z)

Lamps: 1 x SAMSUNG_LH351Z_2x2_367.19lm@250mA_P=2.86596W_I=249.8mA

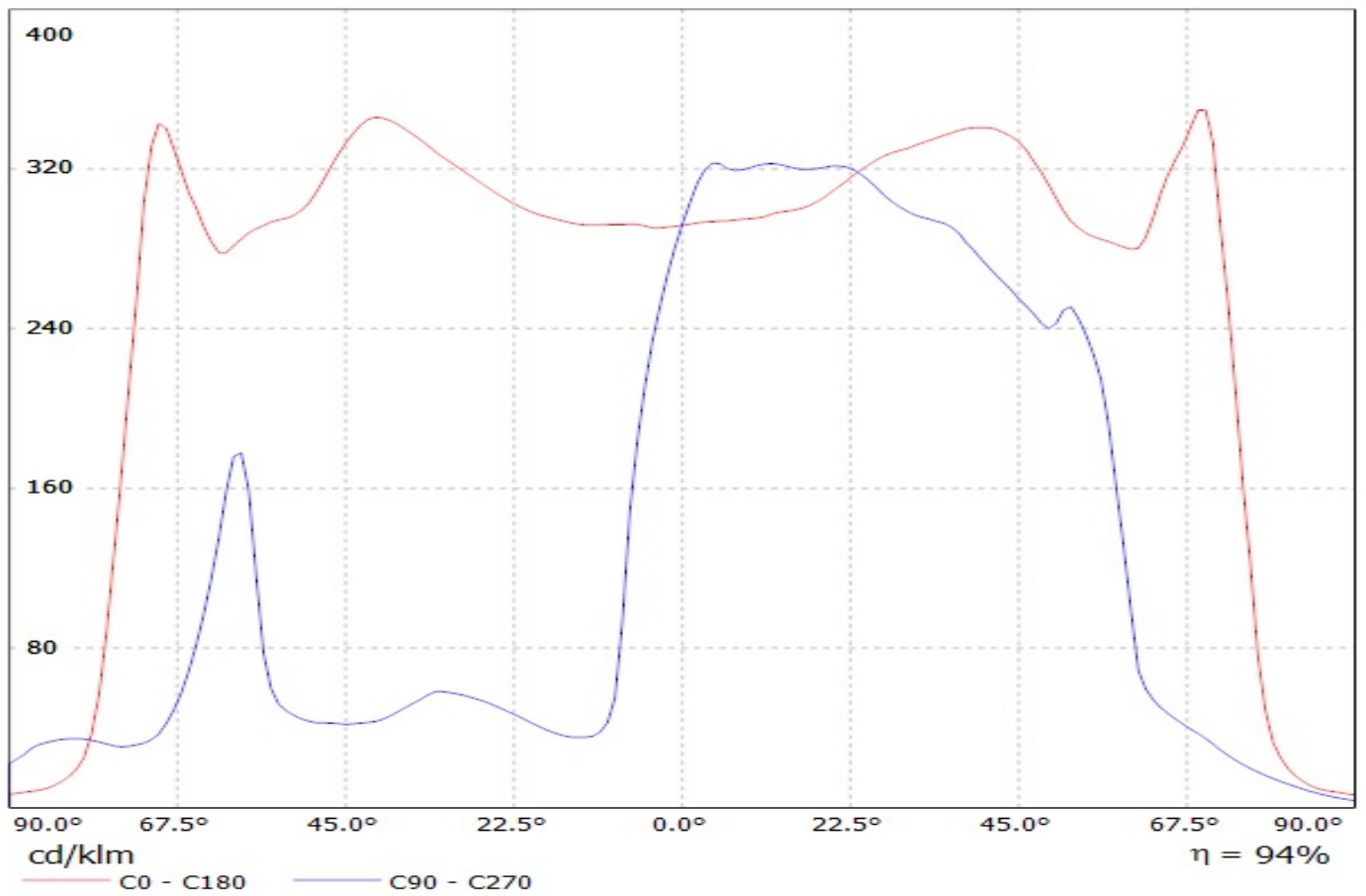

Luminaire: LEDiL Oy C13301_STRADA-2X2-T3_(LH351D)
Lamps: 1 x Samsung_LH351D_524.264lm@250mA_P=2.7523W_I=0.250A

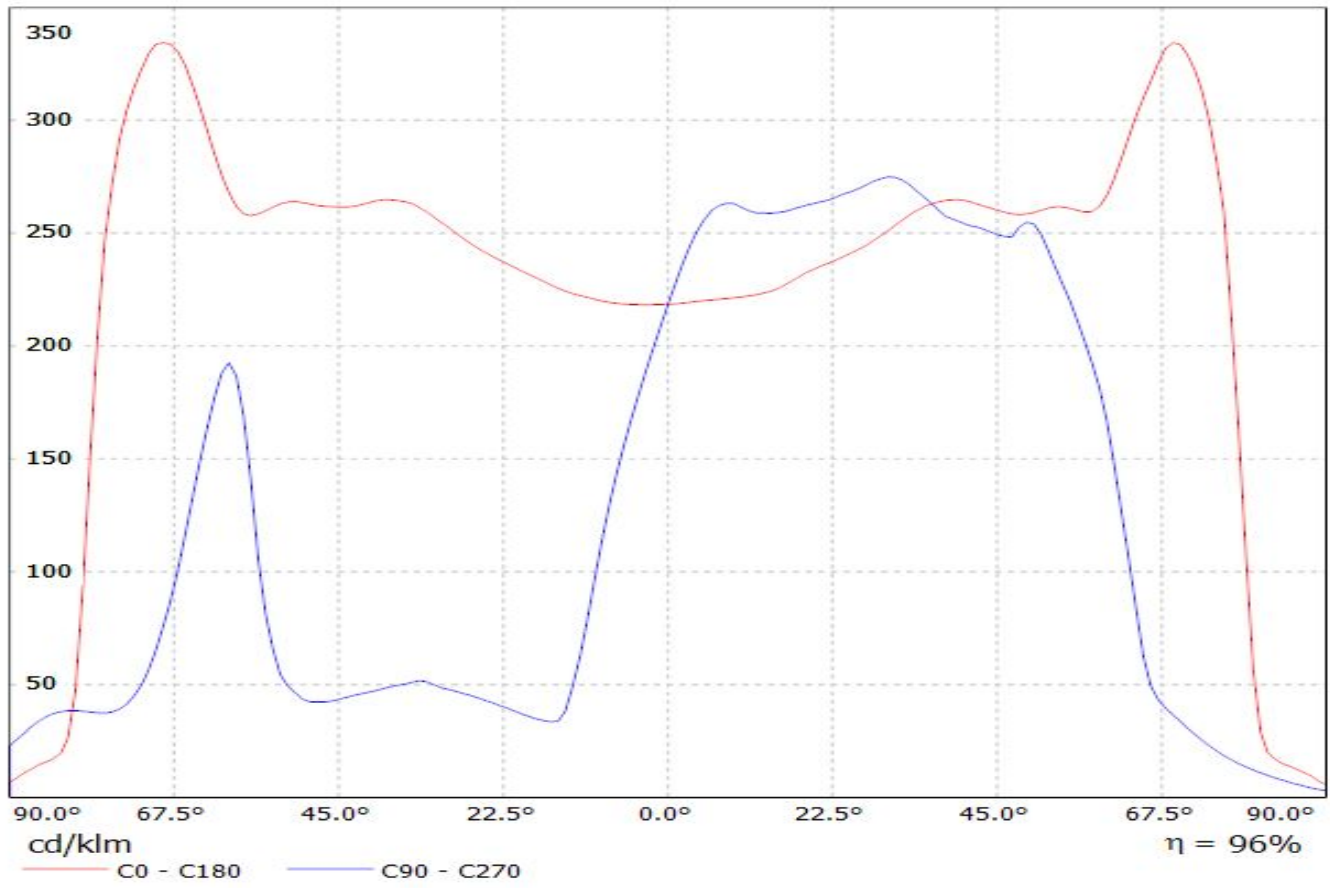

Luminaire: Ledil C13301_STRADA-2X2-T3_(LH351C)
Lamps: 1 x Samsung_LH351C_518.223lm@250mA_P=2.85225W_I=0.25A

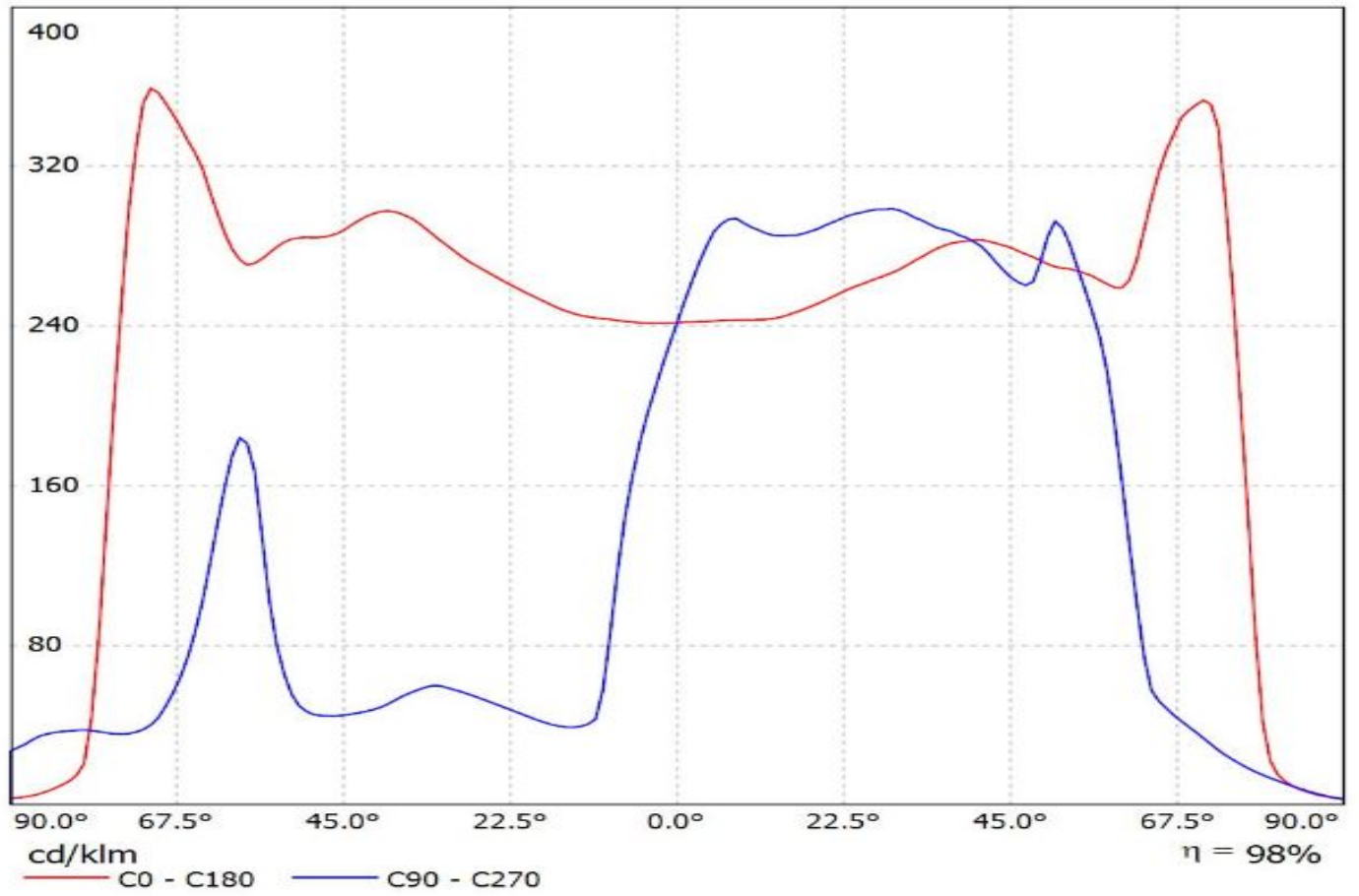

Luminaire: Ledil C13301_STRADA-2X2-T3_(LH508A)

Lamps: 1 x Samsung_LH508A_2x2_2060.04lm@160mA_CCT=5000K_CRI=80_P=15.5405W_I=0.16A

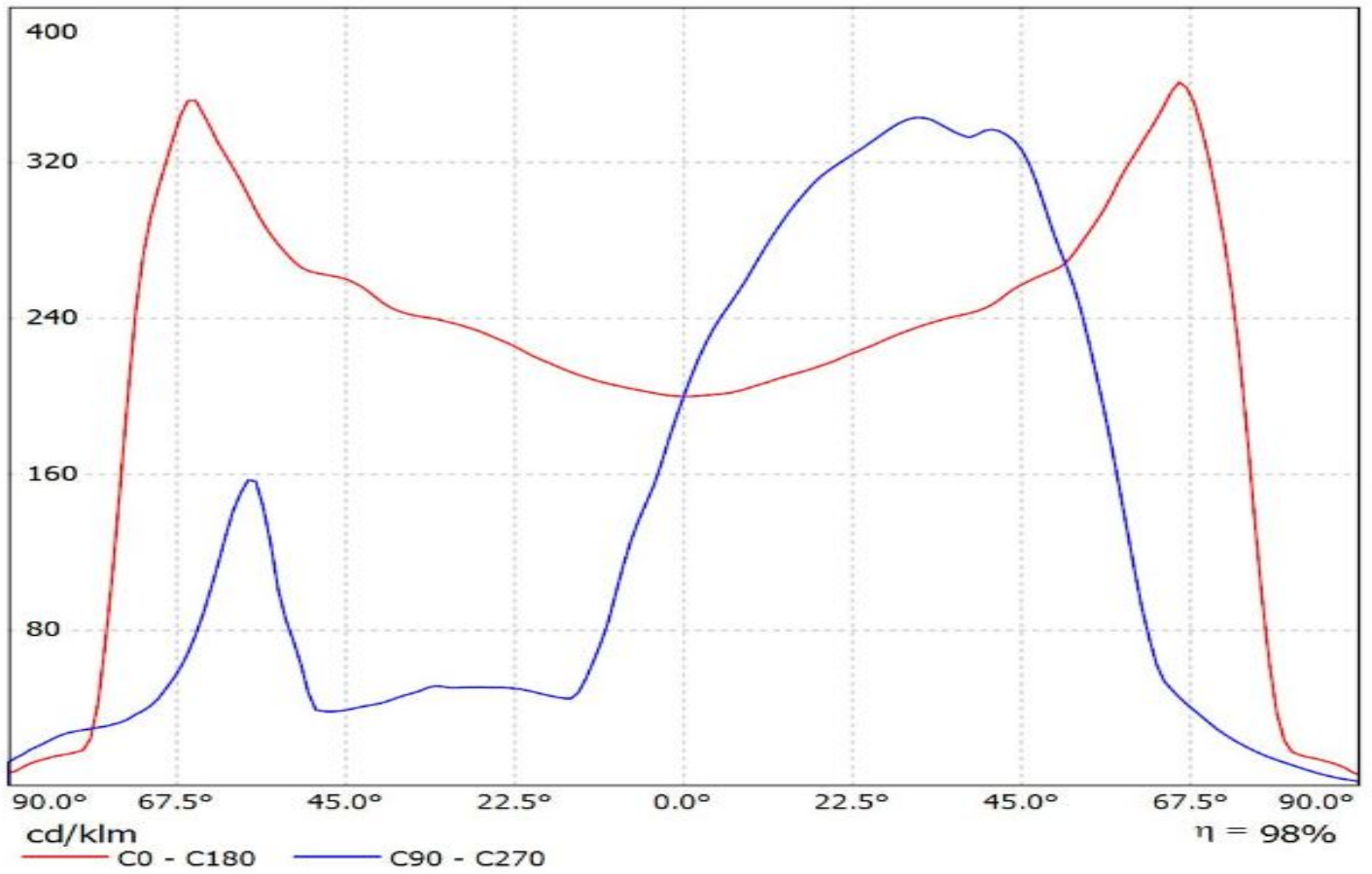

LEDiL Oy C13301_STRADA-2X2-T3_(Z5P) Eff.94.3% / LDC (Linear)

Luminaire: LEDiL Oy C13301_STRADA-2X2-T3_(Z5P) Eff.94.3%

Lamps: 1 x Seoul Z5P (290lm@250mA)

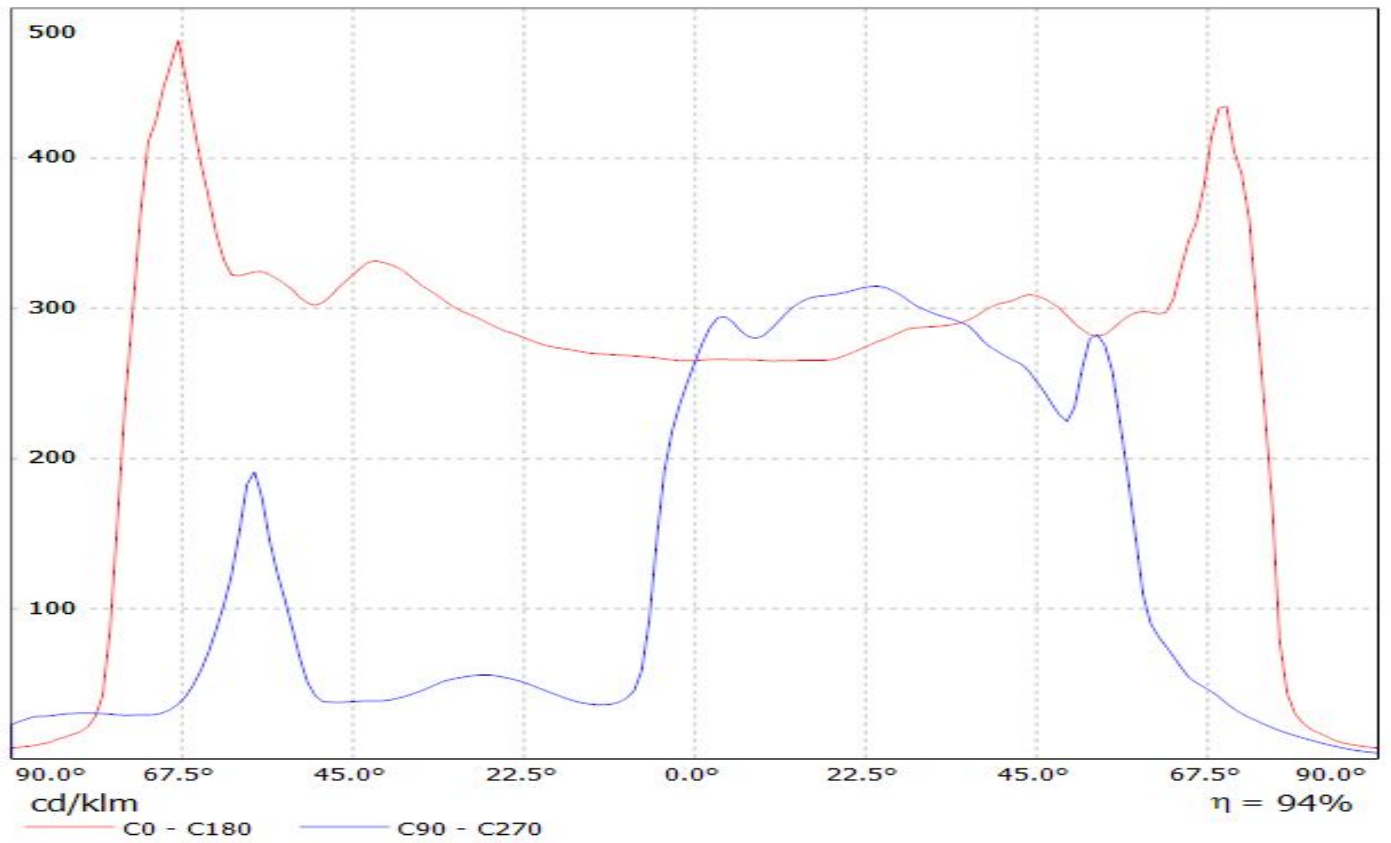

LEDiL Oy C13301_STRADA-2x2-T3_(MJT4040) Eff.94.0% / LDC (Linear)

Luminaire: LEDiL Oy C13301_STRADA-2x2-T3_(MJT4040) Eff.94.0%

Lamps: 1 x SEOUL ACHRICH MJT4040 (SAW09H0A) 258lm@40mA P=2.37W I=40mA

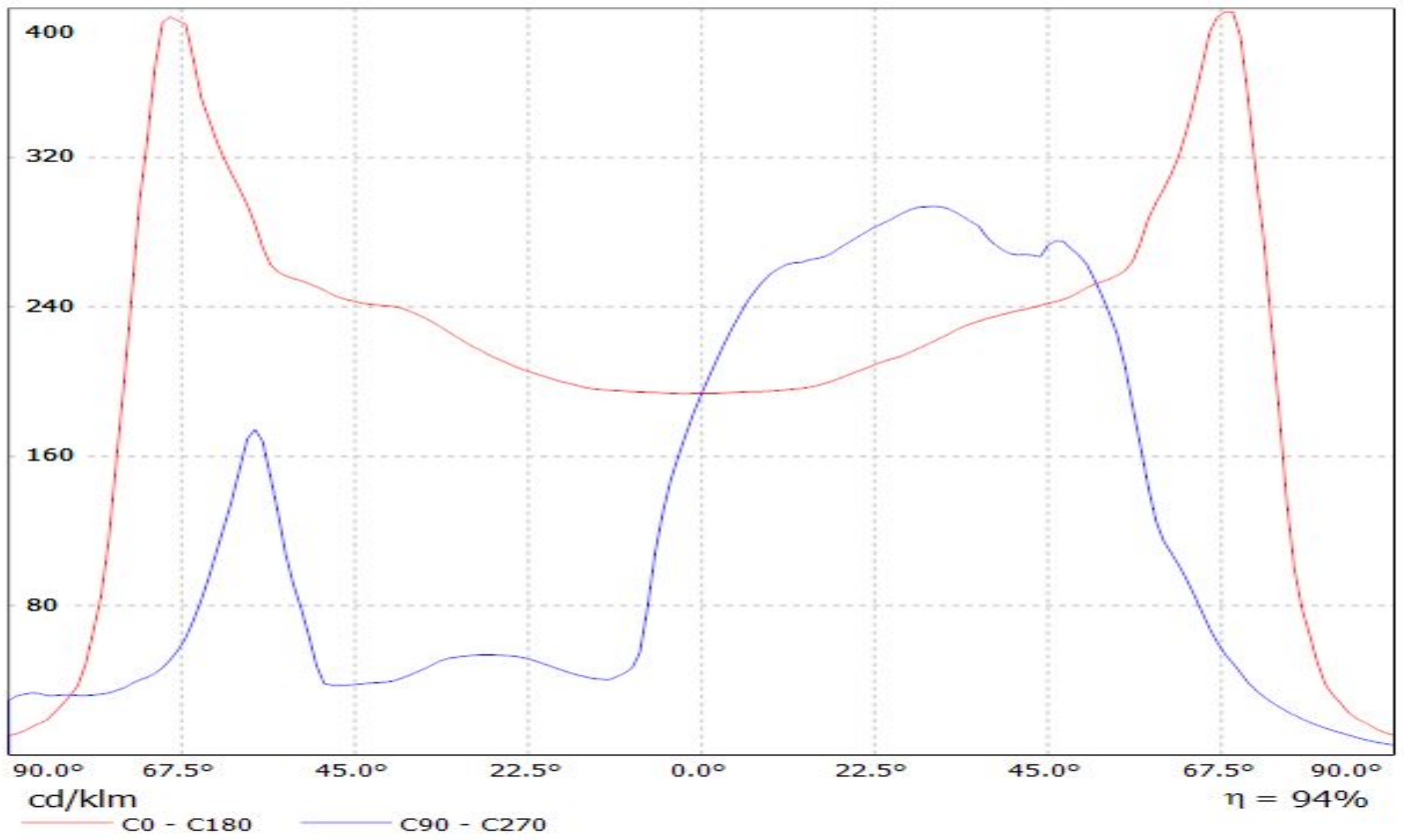

LEDiL Oy C13301_STRADA-2X2-T3_(Z5M) Eff.94.0% / LDC (Linear)

Luminaire: LEDiL Oy C13301_STRADA-2X2-T3_(Z5M) Eff.94.0%

Lamps: 1 x SEOUL_Z5M_(SZ5-M0-W0-00)_362.8lm@250mA_P=2.95788W_I=249.8mA

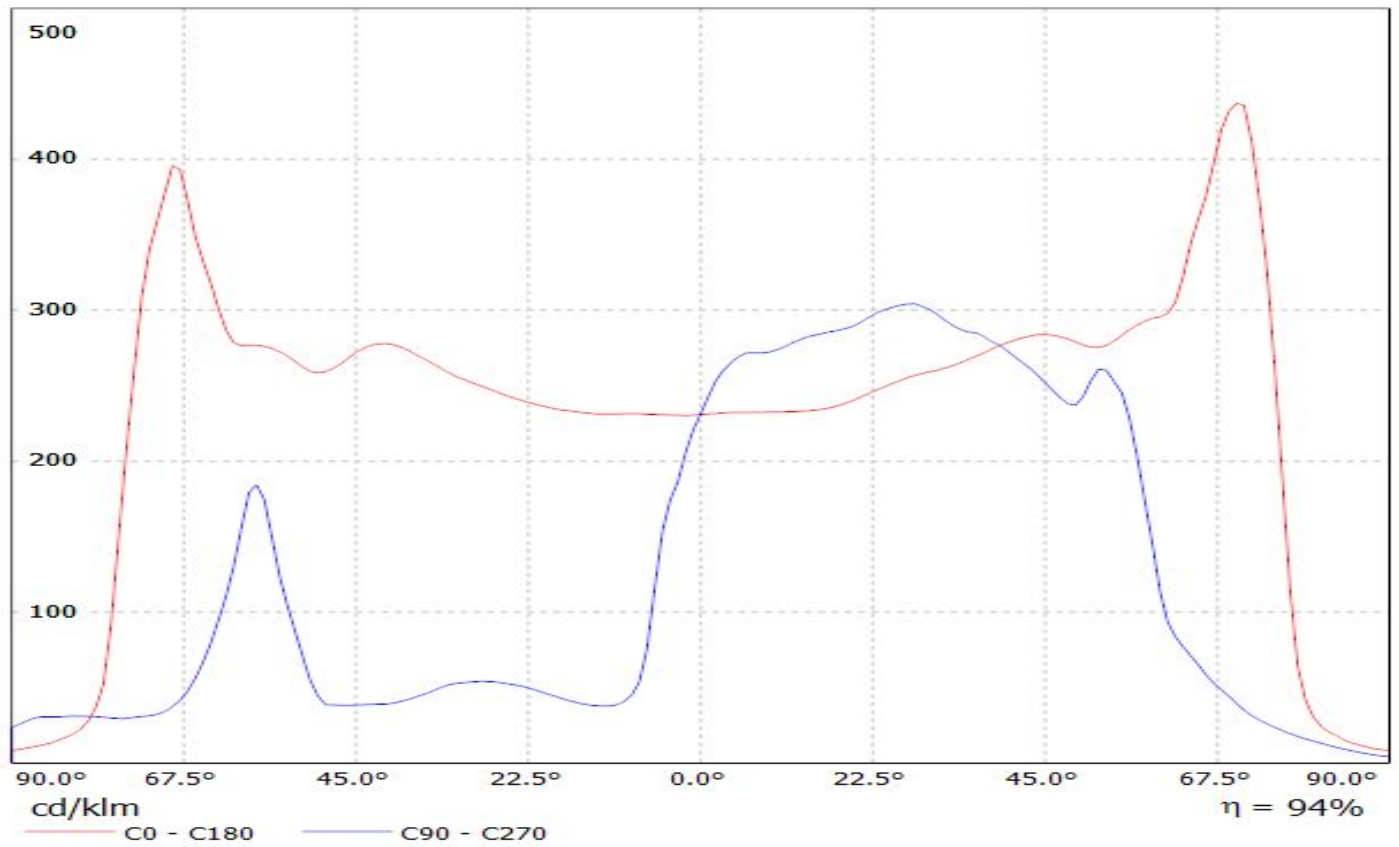

Luminaire: LEDil Oy C13301_STRADA-2X2-T3_(Z5M1) Efficiency=94%
Lamps: 1 x Seoul Z5M1 (SZ5-M1-WN-C8) 379lm @ 250mA CCT=4600K P=2.9W I=250mA

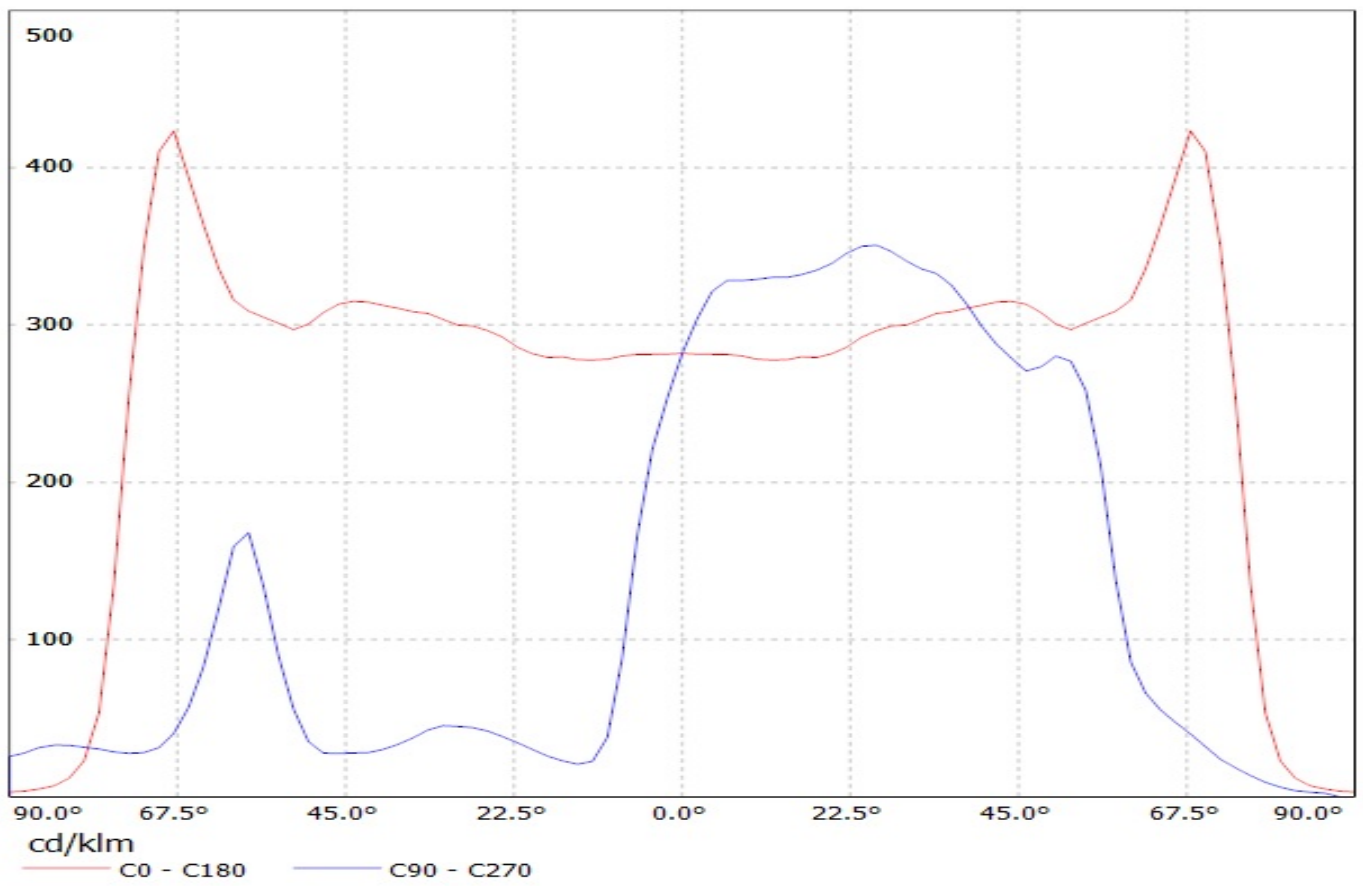

Luminaire: Ledil C13301_STRADA-2X2-T3_(Z8Y22plus)

Lamps: 1 x Seoul_Z8Y22plus_(W6E2G)_513.996lm@250mA_P=2.754W_I=0.250A

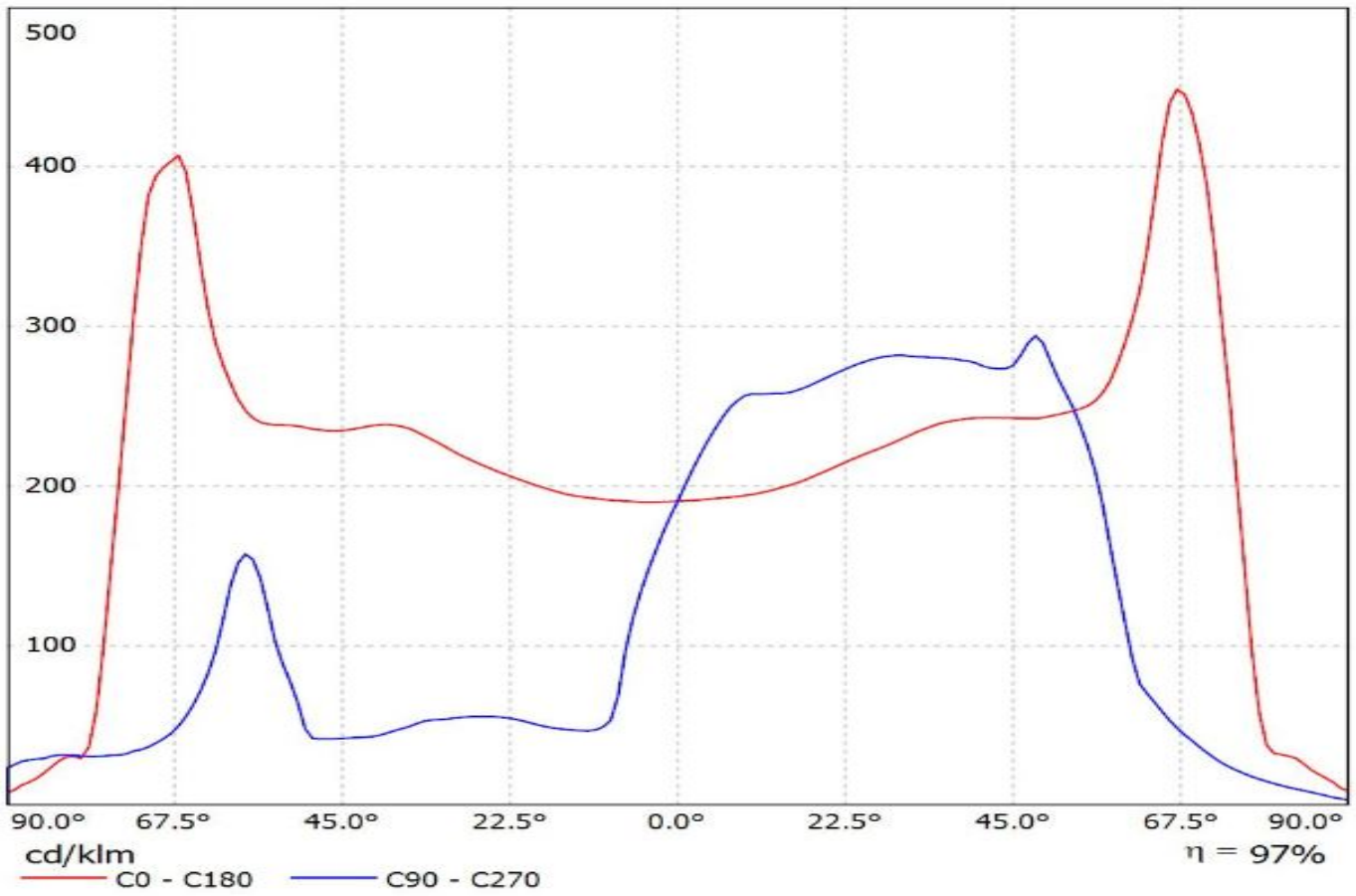

Luminaire: Ledil Oy C13301_STRADA-2X2-T3_(Z8Y22)_SIMULATED
Lamps: 1 x Seoul SZ8Y22

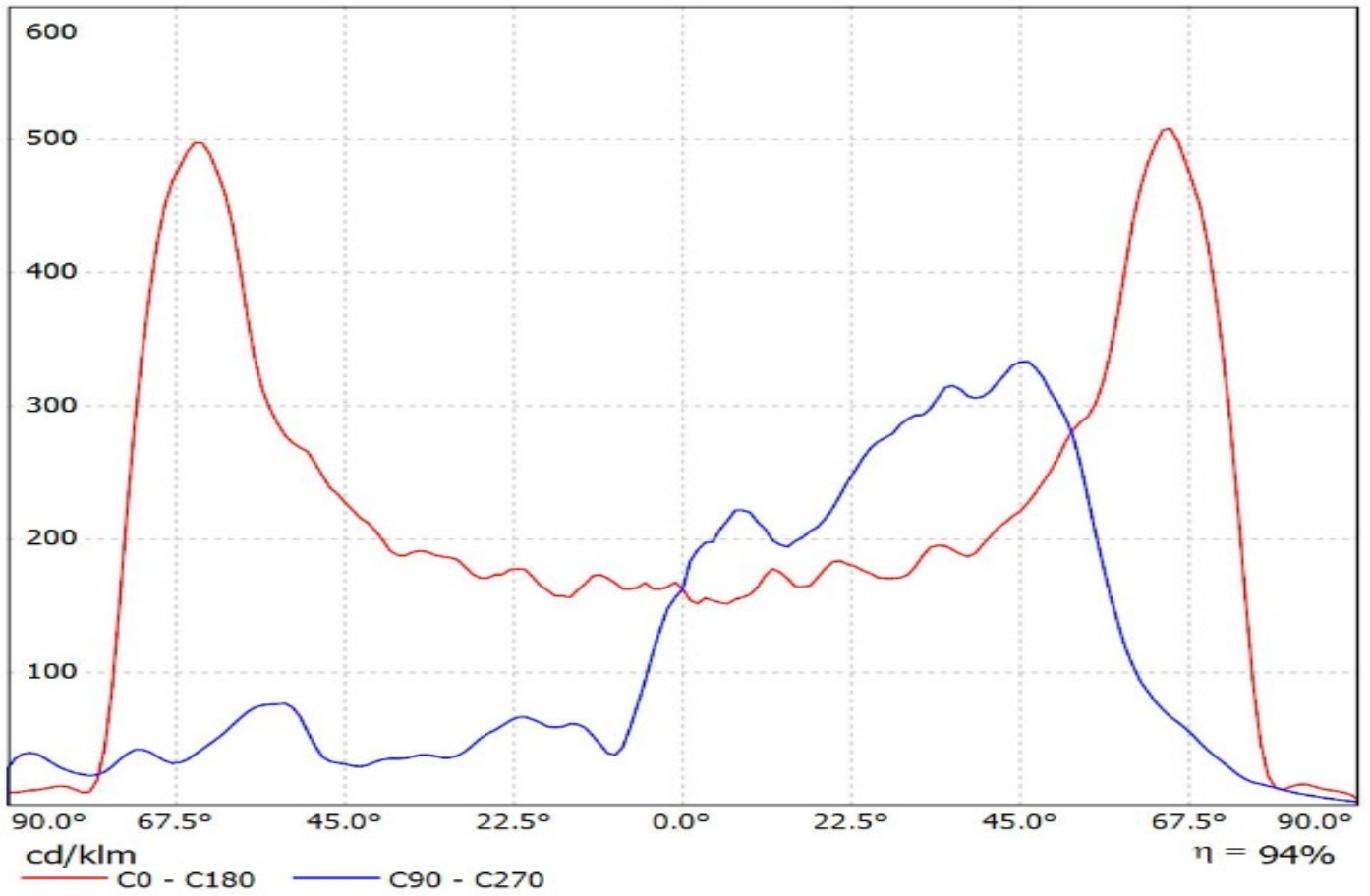

Luminaire: LEDiL Oy C13301_STRADA-2X2-T3_(Z8Y22)

Lamps: 1 x Seoul_Wicop_Z8Y22_497.373lm@250mA_P=2.80076W_U=11.211V

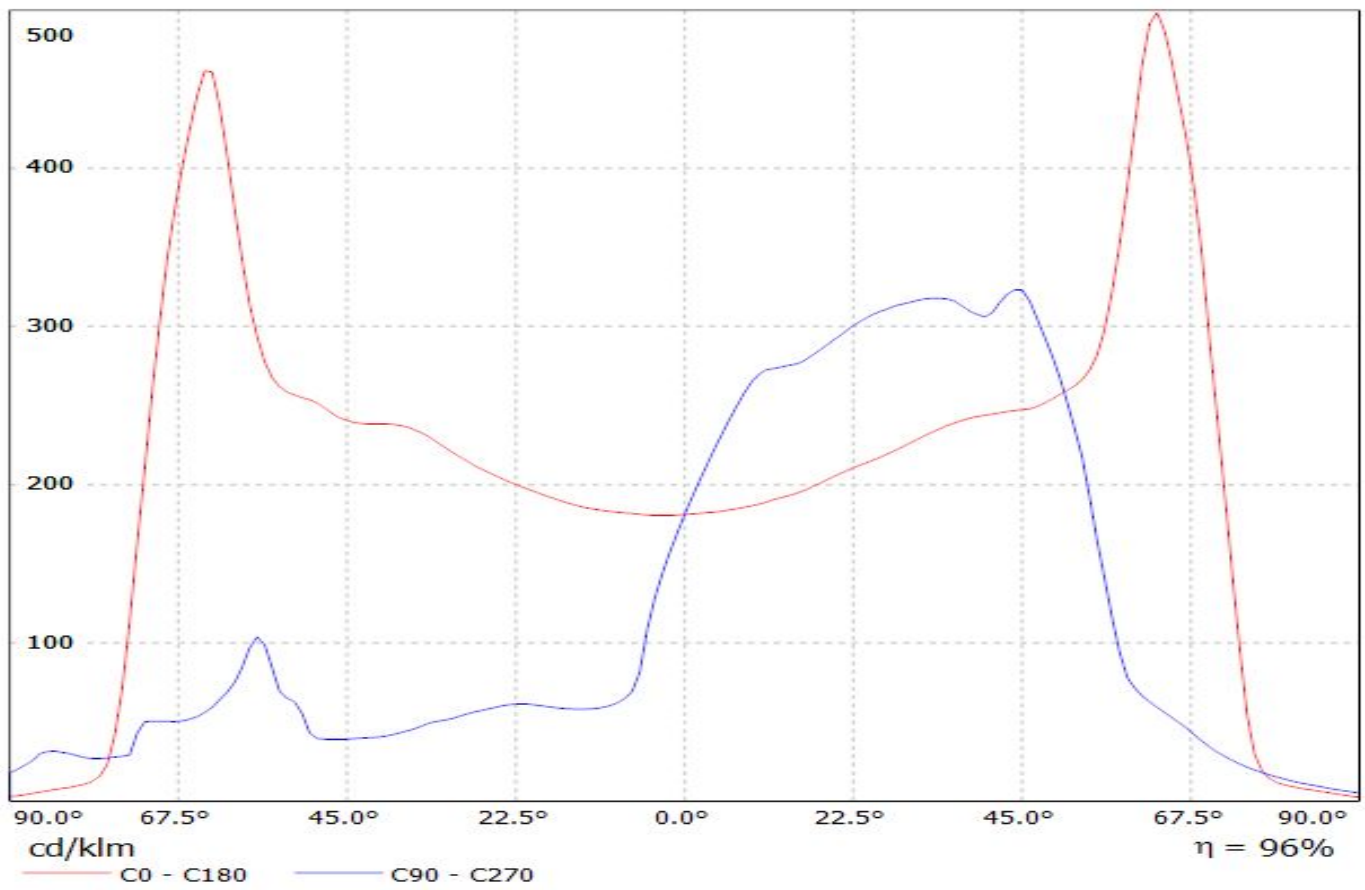

Ledil C13301_STRADA-2X2-T3_(TL1L3) / LDC (Linear)

Luminaire: Ledil C13301_STRADA-2X2-T3_(TL1L3)

Lamps: 1 x Toshiba_TL1L3_2x2_(TL1L3-NW1.L)_387.773lm@250mA_CCT=5000K_P=2.829W_I=0.25A

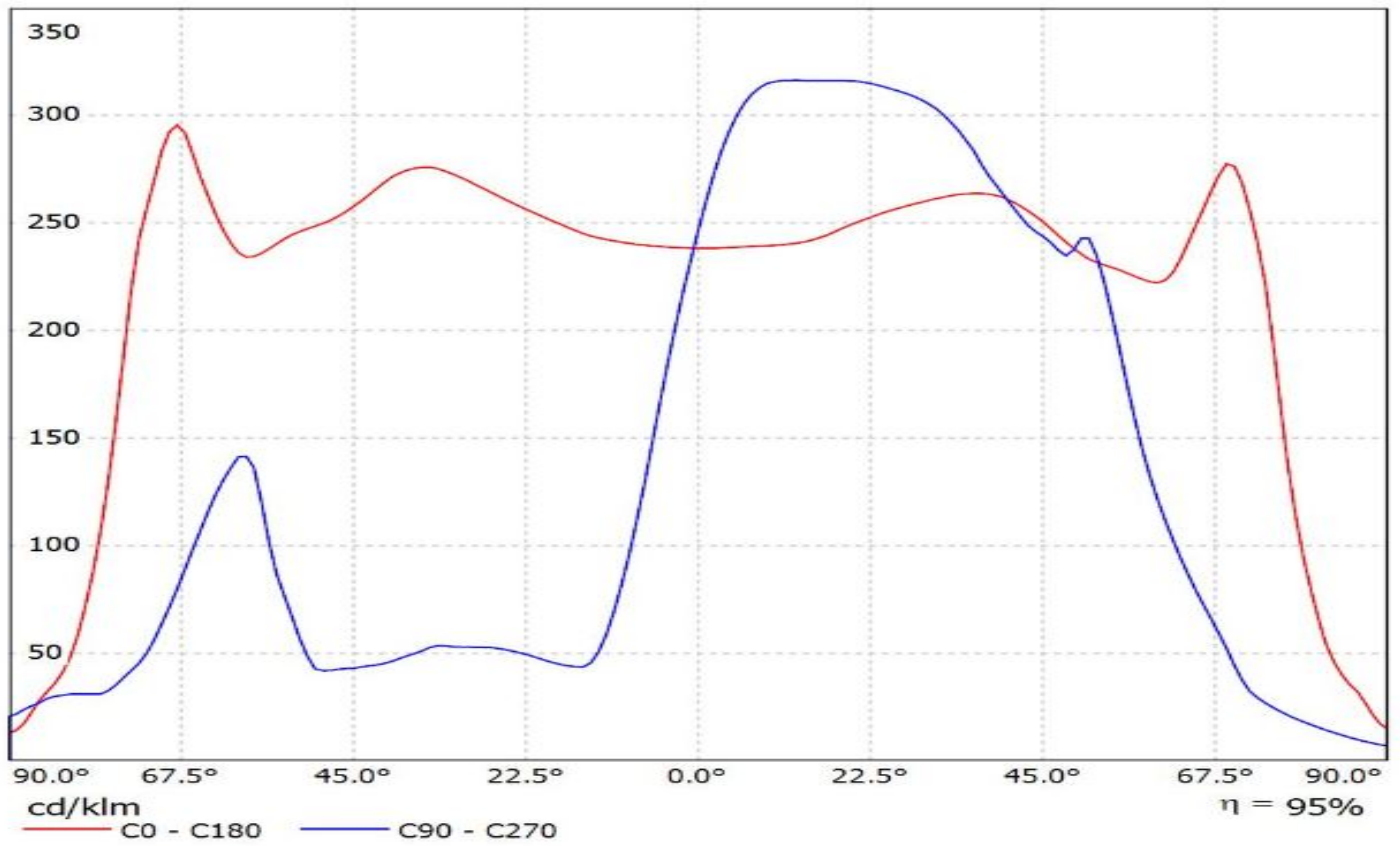

Ledil C13301_STRADA-2X2-T3_(TL1L4) / LDC (Linear)

Luminaire: Ledil C13301_STRADA-2X2-T3_(TL1L4)

Lamps: 1 x Toshiba_TL1L4_2x2_(TL1L4-DW0)_472.639lm@250mA_CCT=6500K_P=2.9W_I=0.25A

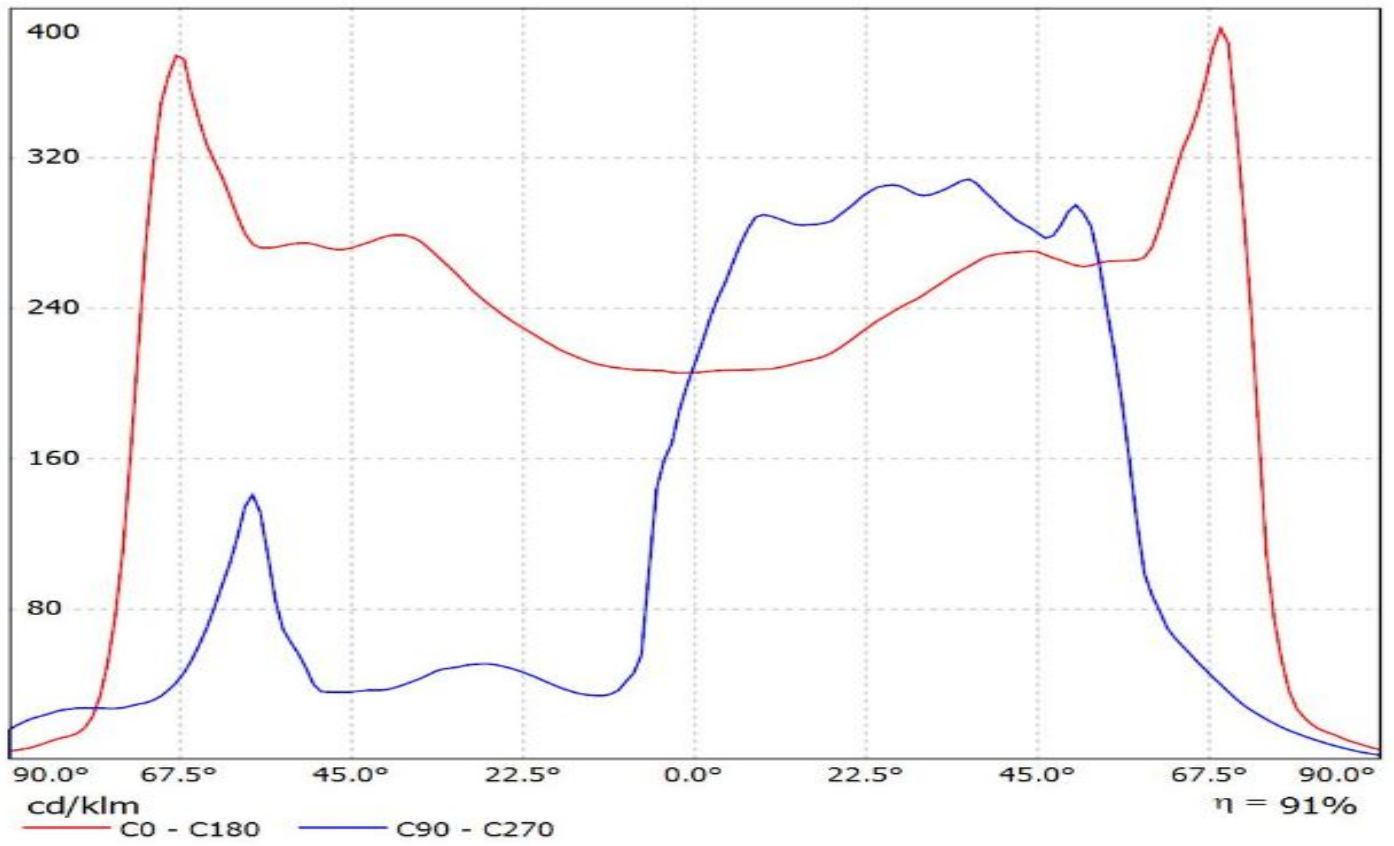

Luminaire: LEDiL Oy C13301_STRADA-2X2-T3_(Tridonic_Module_RLE_G1)
Lamps: 1 x Tridonic_Module_RLE_G1_4576.03lm@700mA_P=32.0681W_I=0.700A

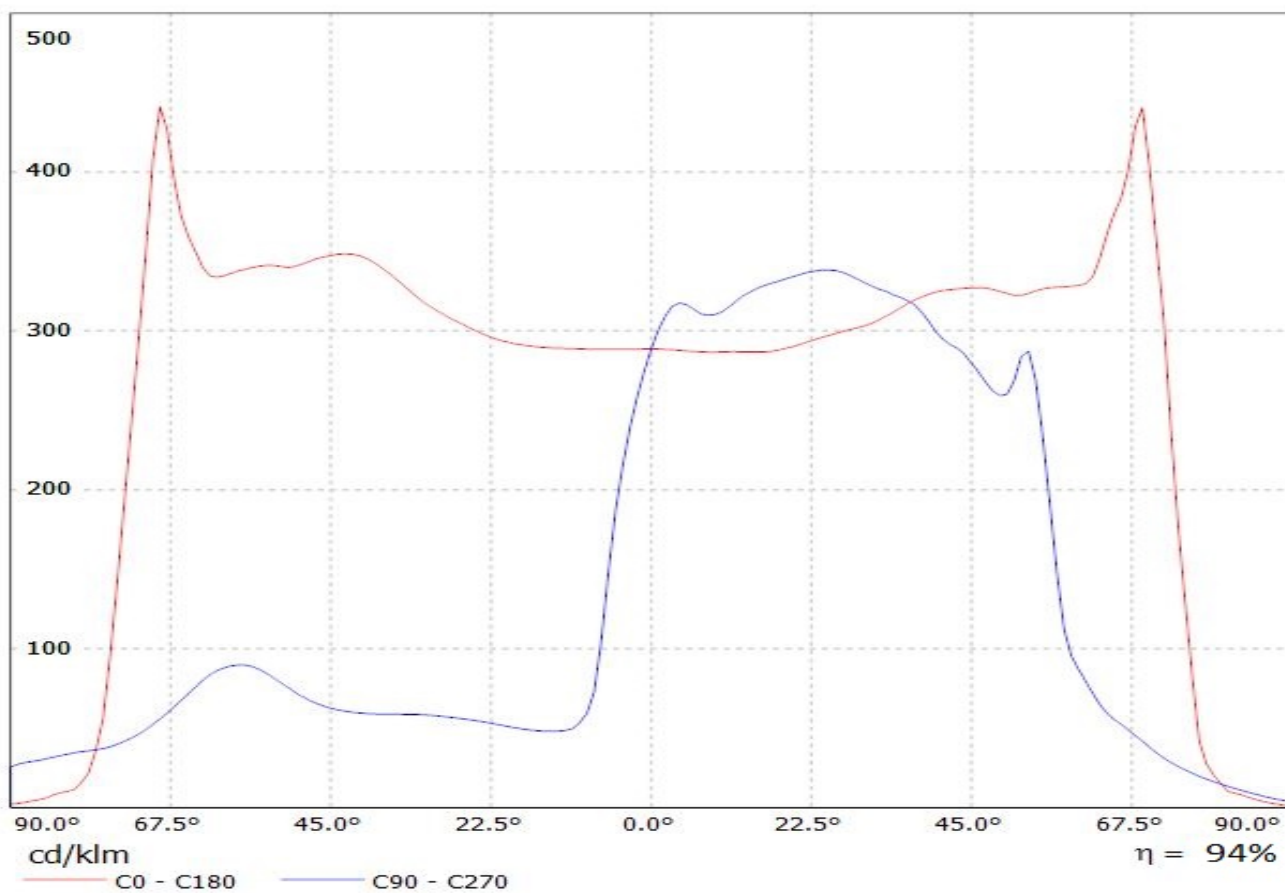

Luminaire: LEDiL Oy C13301_STRADA-2X2-T3_(Tridonic_Module_RLE_G1)
Lamps: 1 x Tridonic_Module_RLE_G1_4576.03lm@700mA_P=32.0681W_I=0.700A

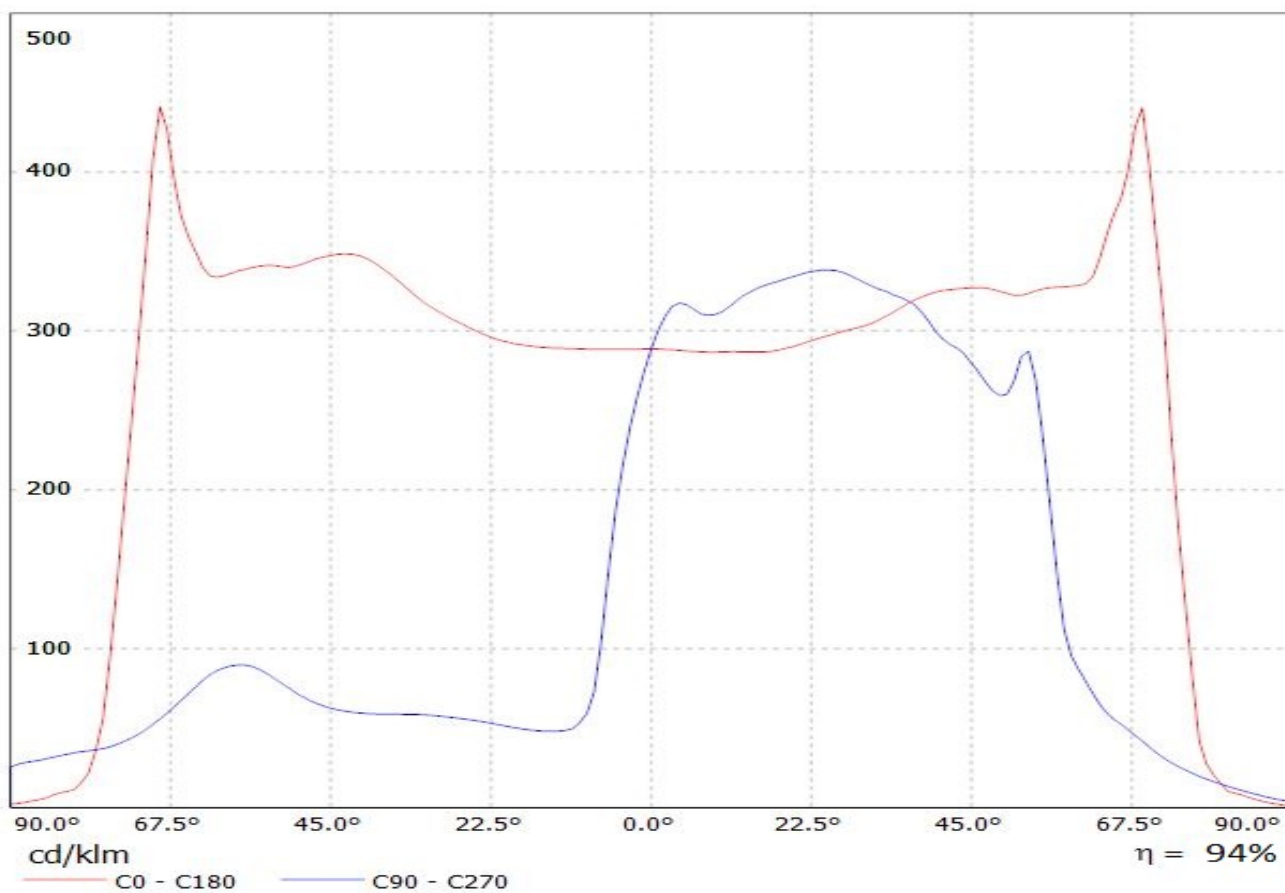

Luminaire: LEDiL Oy C13301_STRADA-2X2-T3_(Tridonic_Module_RLE_G1)
Lamps: 1 x Tridonic_Module_RLE_G1_2288lm@700mA_P=16W_I=0.700A

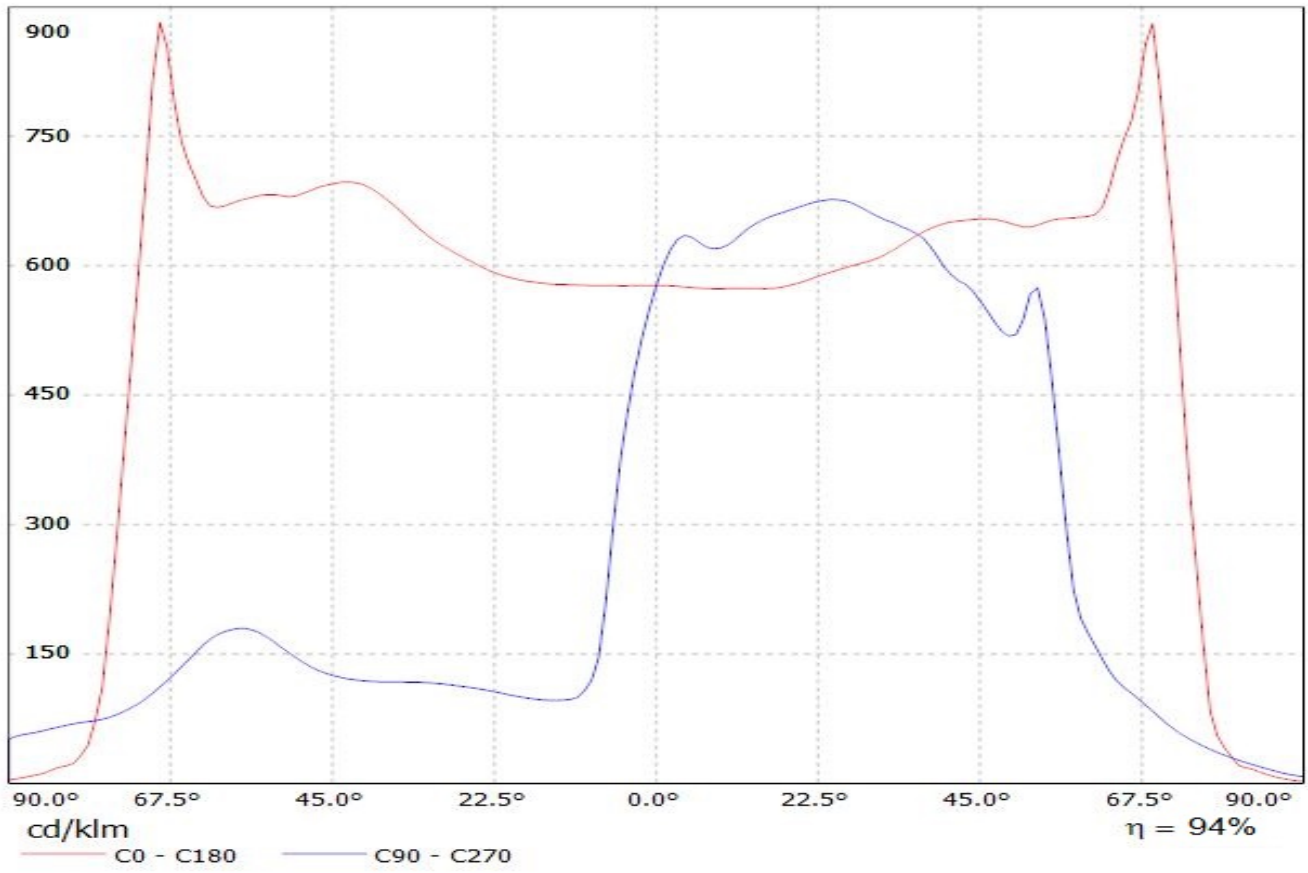

Luminaire: LEDiL Oy C13301_STRADA-2X2-T3_(Tridonic_Module_RLE_G1)
Lamps: 1 x Tridonic_Module_RLE_G1_2288lm@700mA_P=16W_I=0.700A

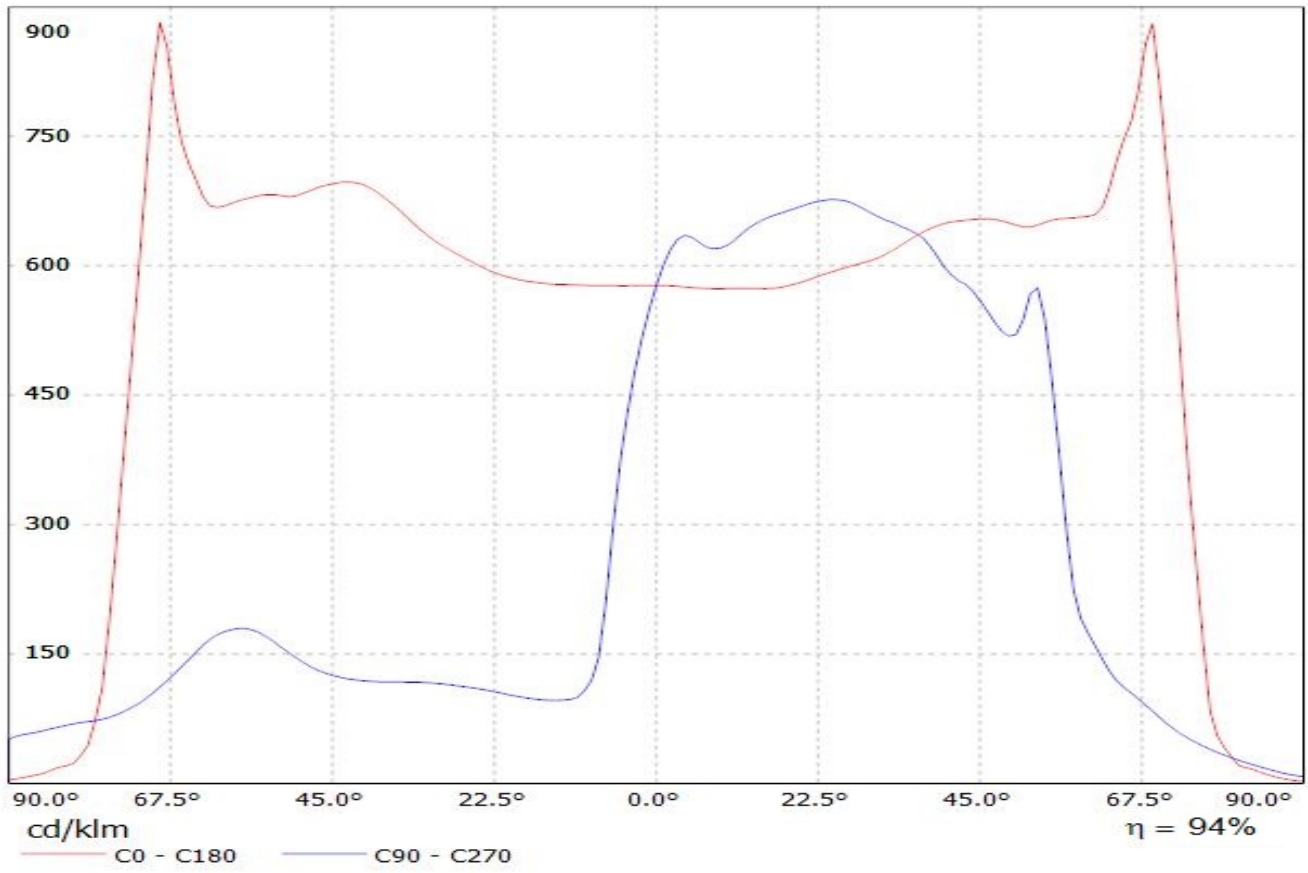

Luminaire: LEDiL Oy C13301_STRADA-2X2-T3_(Bridgelux_5050_Gen2)

Lamps: 1 x Bridgelux_5050_Gen2_2x2_(BXEP-57C-435-09B)_1447.45lm@250mA_CCT=5700K_P=8.29761W_I=0.25A

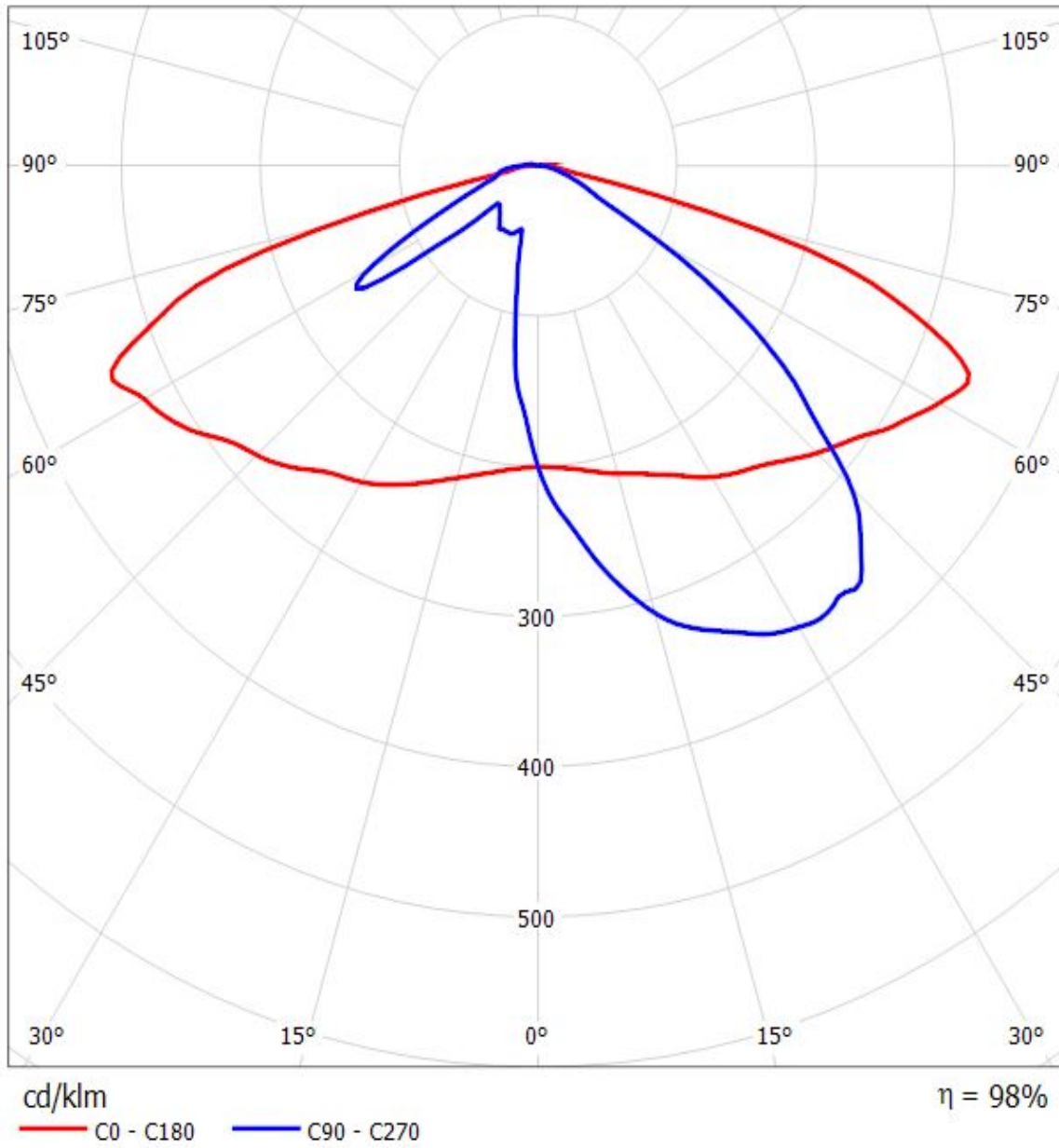

Luminaire: LEDiL Oy C13301_STRADA-2X2-T3_(QUICK_FLUX_XTP_2x4_740_LS_G5)
Lamps: 1 x QUICK_FLUX_XTP_2x4_740_LS_G5_969.2lm@250mA_P=5.68795W_I=0.25A

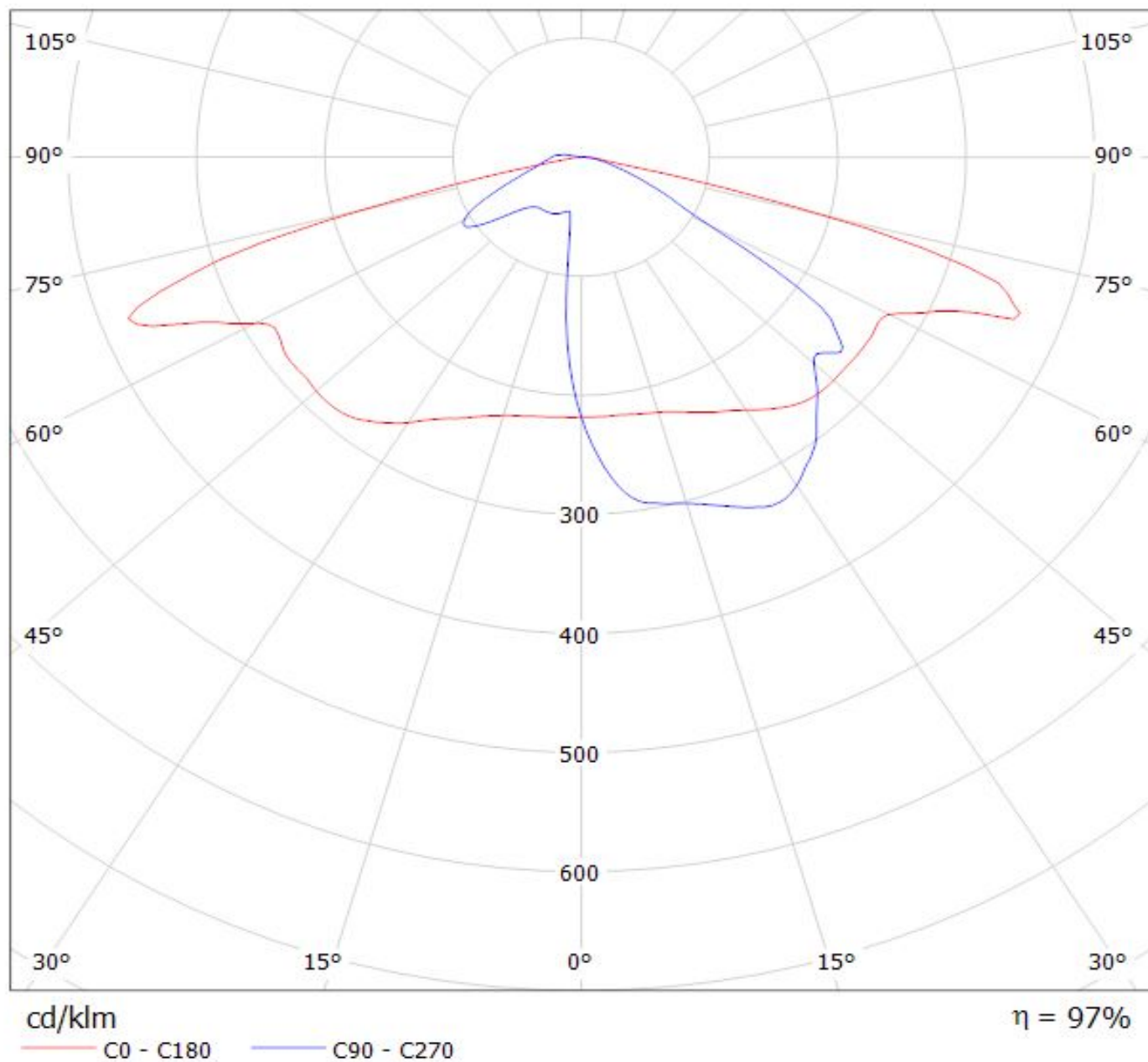

Luminaire: Ledil C13301_STRADA-2X2-T3_(QUICK_FLUX_XTP_2x6_740_LS_G5)

Lamps: 1 x QUICK_FLUX_XTP_2x6_740_LS_G5_1447.53lm@250mA_P=8.58406W_I=0.25A

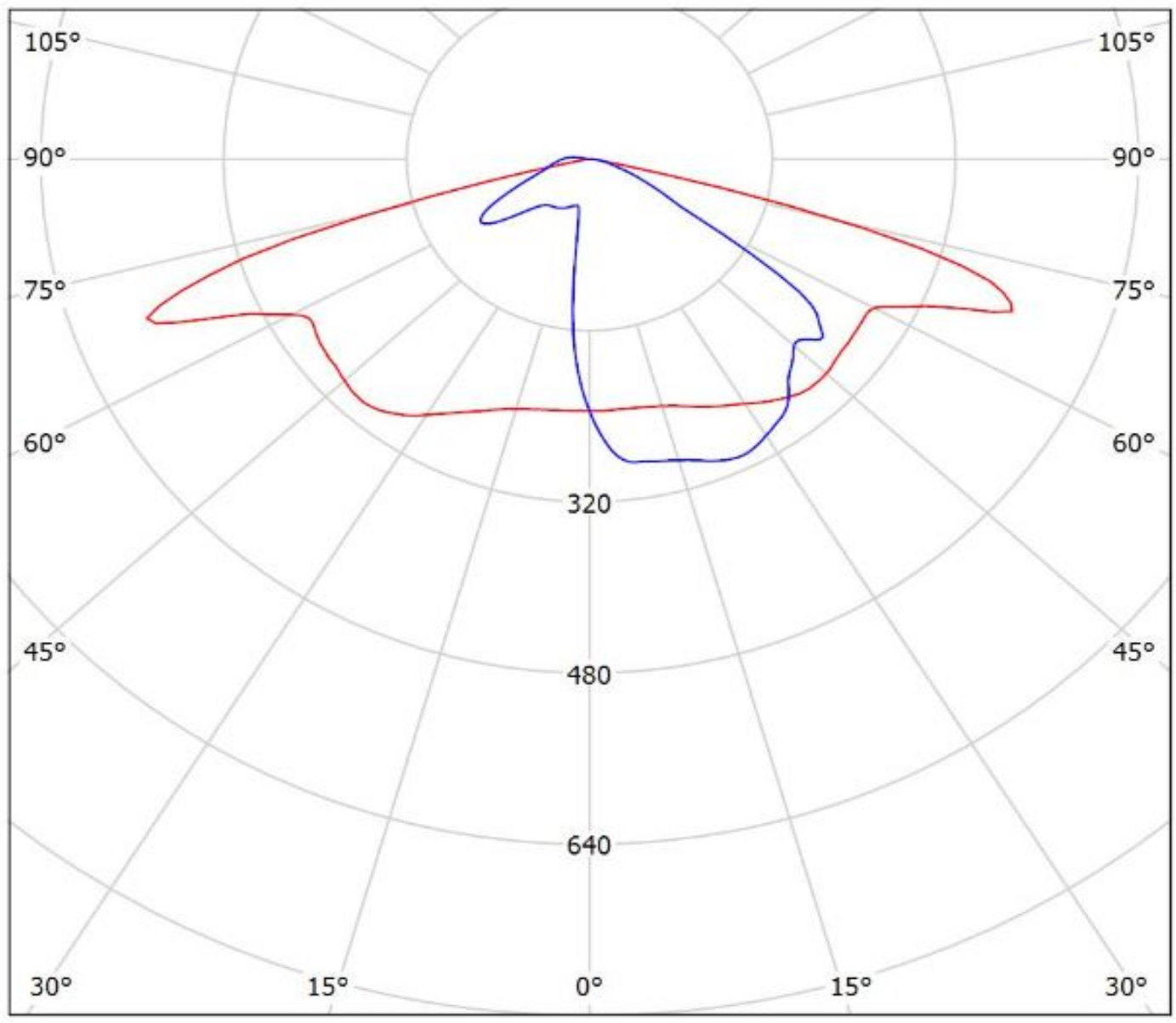

cd/klm
— C0 - C180 — C90 - C270

$\eta = 97\%$

LEDiL Oy C13301_STRADA-2X2-T3_(XP-G) Eff.94.2% / LDC (Polar)

Luminaire: LEDiL Oy C13301_STRADA-2X2-T3_(XP-G) Eff.94.2%

Lamps: 1 x CREE XP-G2 (259lm@250mA)

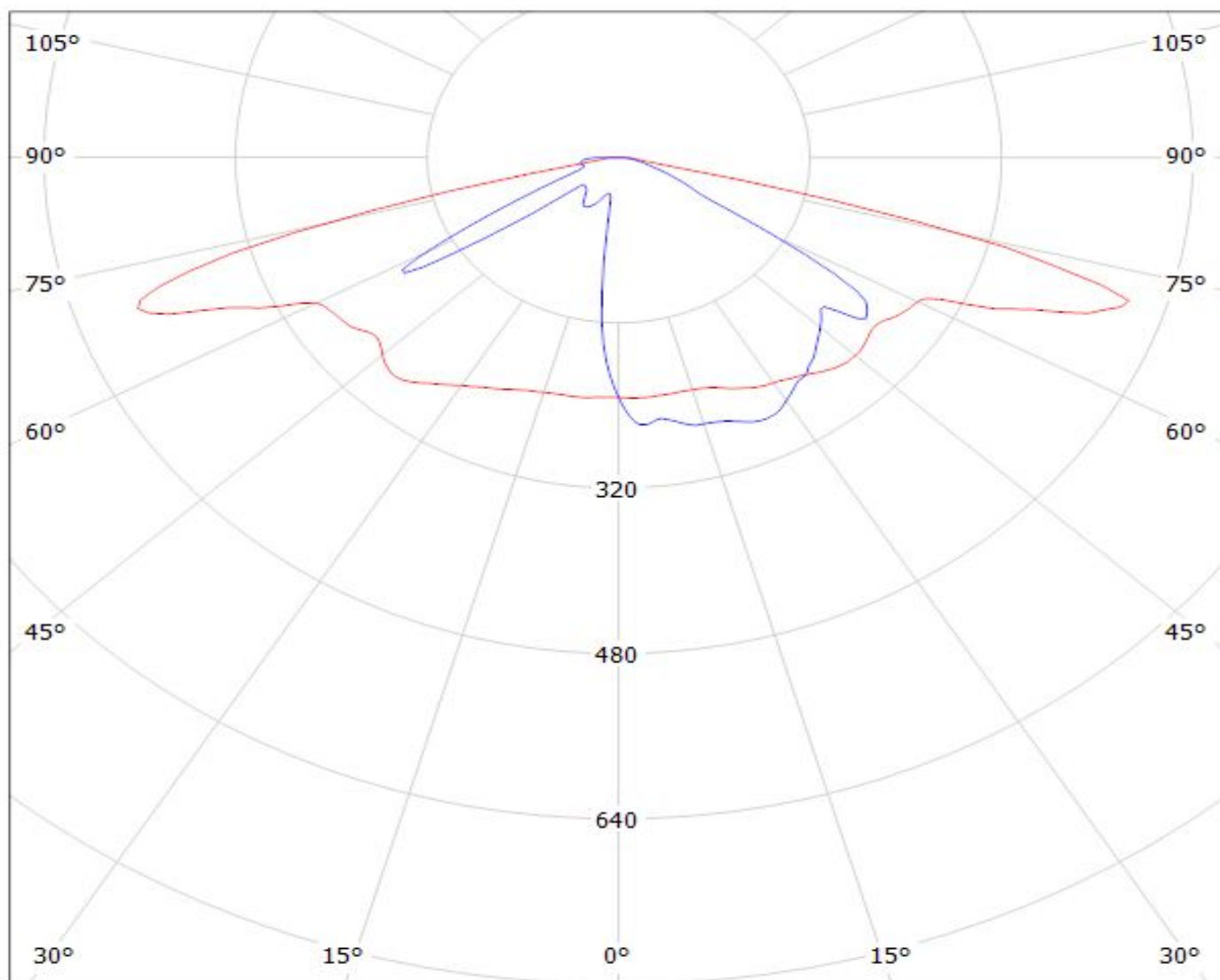

cd/klm

— C0 - C180 — C90 - C270

η = 94%

LEDiL Oy C13301_STRADA-2X2-T3_(XT-E) 95.0% / LDC (Polar)

Luminaire: LEDiL Oy C13301_STRADA-2X2-T3_(XT-E) 95.0%

Lamps: 1 x CREE_XT-E (390lm@250mA)

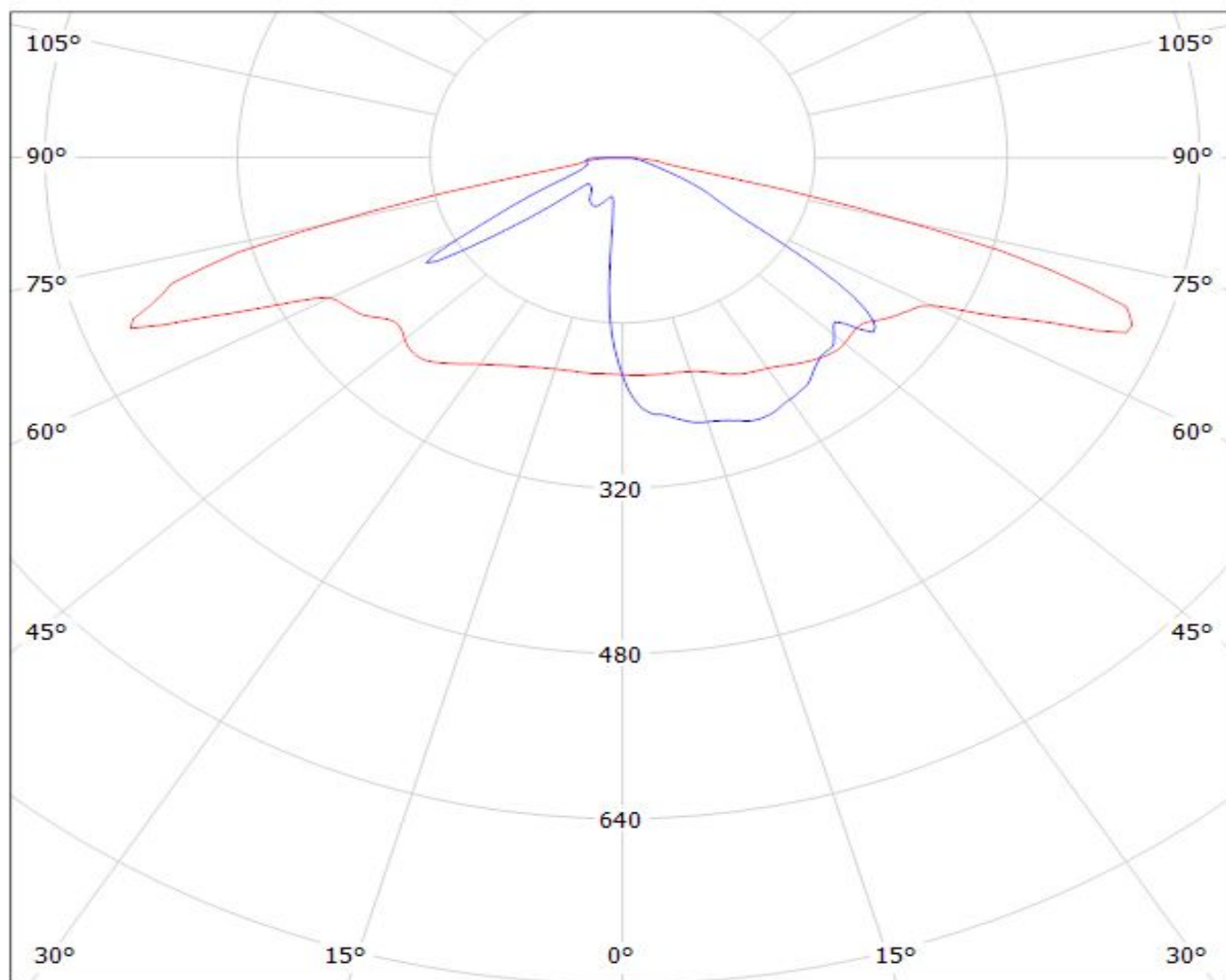

cd/klm

— C0 - C180

— C90 - C270

$\eta = 95\%$

LEDiL Oy C13301_STRADA-2X2-T3_(XM-L2) Eff.94.3% / LDC (Polar)

Luminaire: LEDiL Oy C13301_STRADA-2X2-T3_(XM-L2) Eff.94.3%

Lamps: 1 x XM-L2 (366lm@250mA)

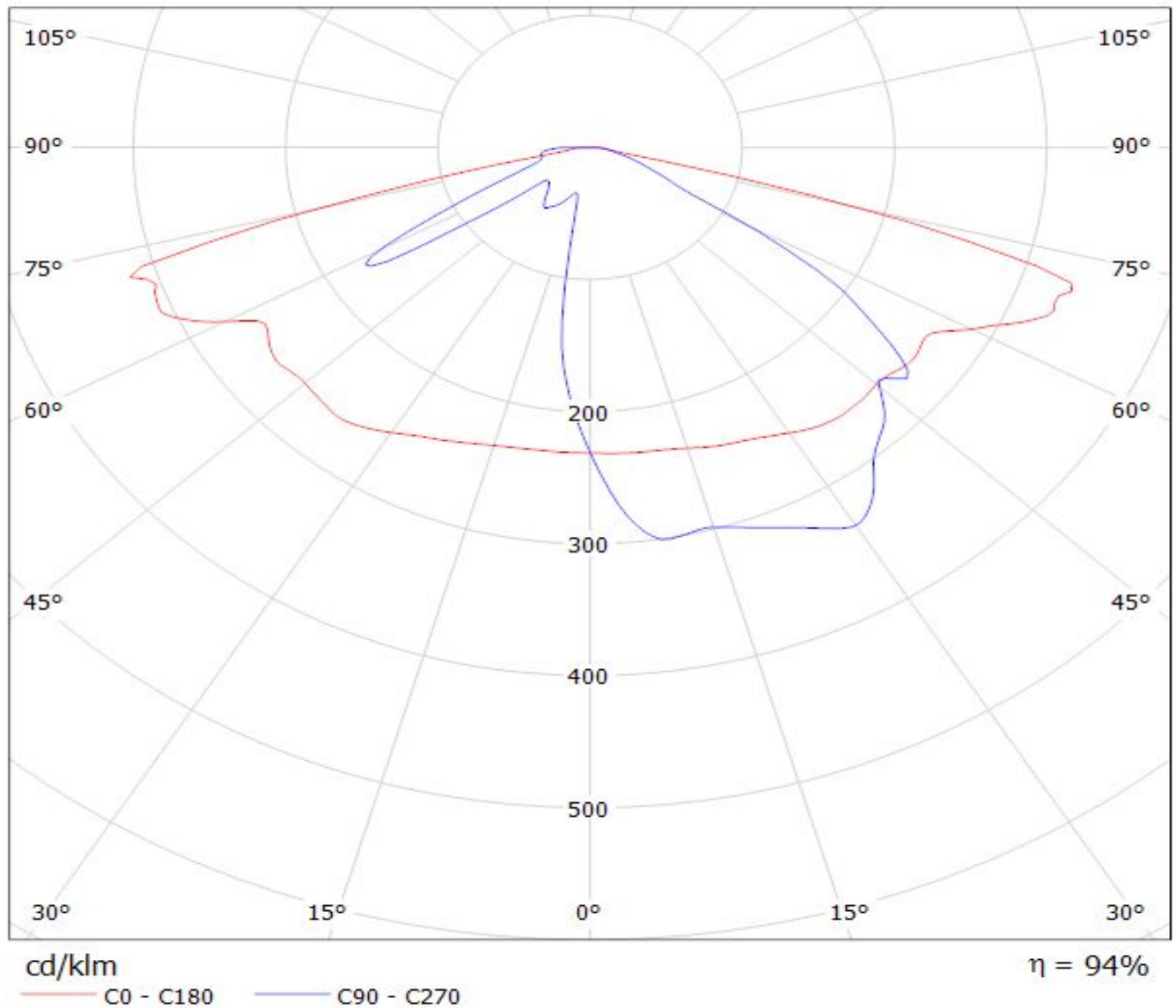

LEDiL Oy C13301_STRADA-2X2-T3_(XP-G2) Eff.92.0% / LDC (Polar)

Luminaire: LEDiL Oy C13301_STRADA-2X2-T3_(XP-G2) Eff.92.0%

Lamps: 1 x CREE XP-G2 (433lm@250mA)

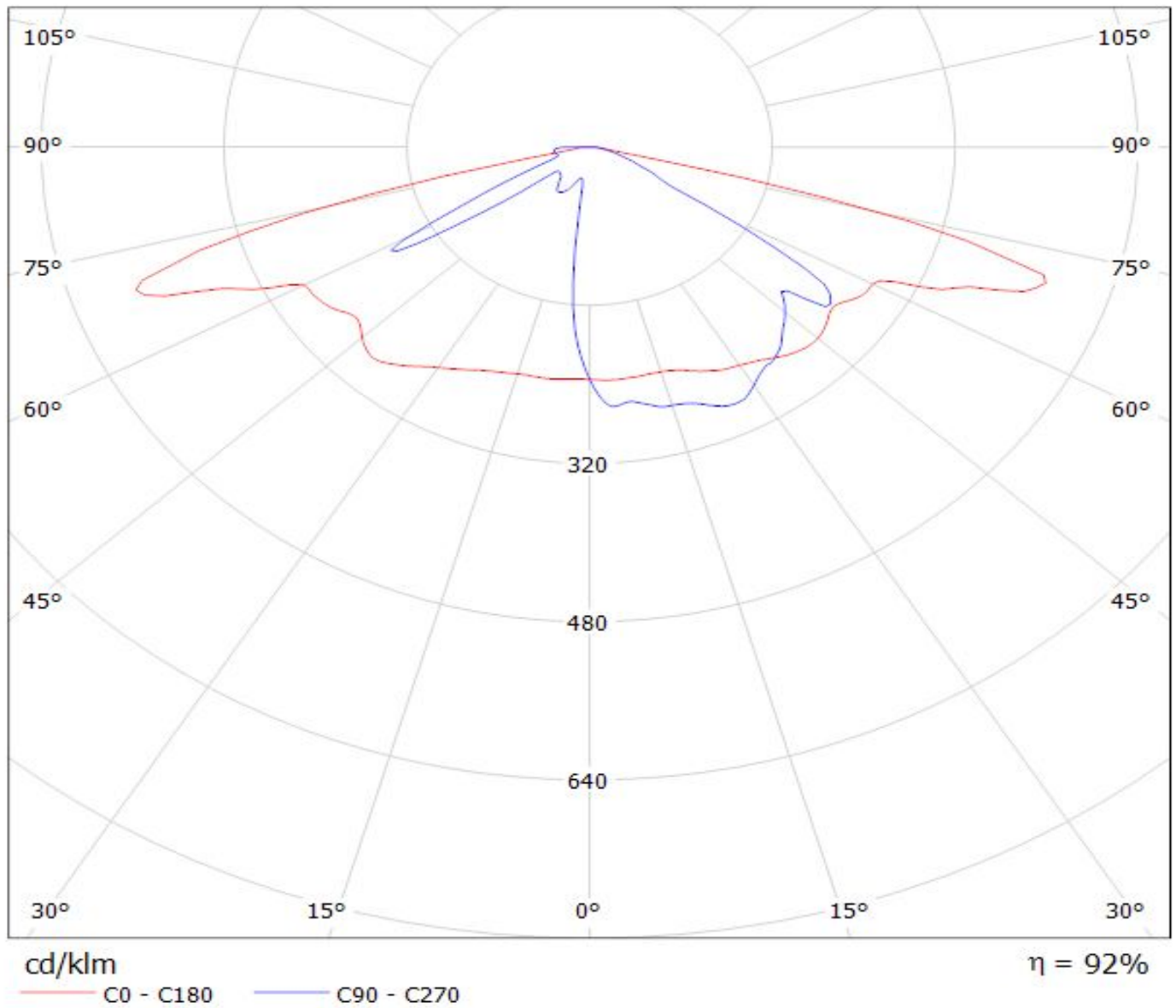

LEDiL Oy C13301_STRADA-2X2-T3_(XP-E2) Eff.94.0% / LDC (Polar)

Luminaire: LEDiL Oy C13301_STRADA-2X2-T3_(XP-E2) Eff.94.0%

Lamps: 1 x CREE_XP-E2_2x2_(XPEBWT-L1-7B4-Q4-0-01)

_340.57lm@250mA_P=2.92366W_I=249.8mA

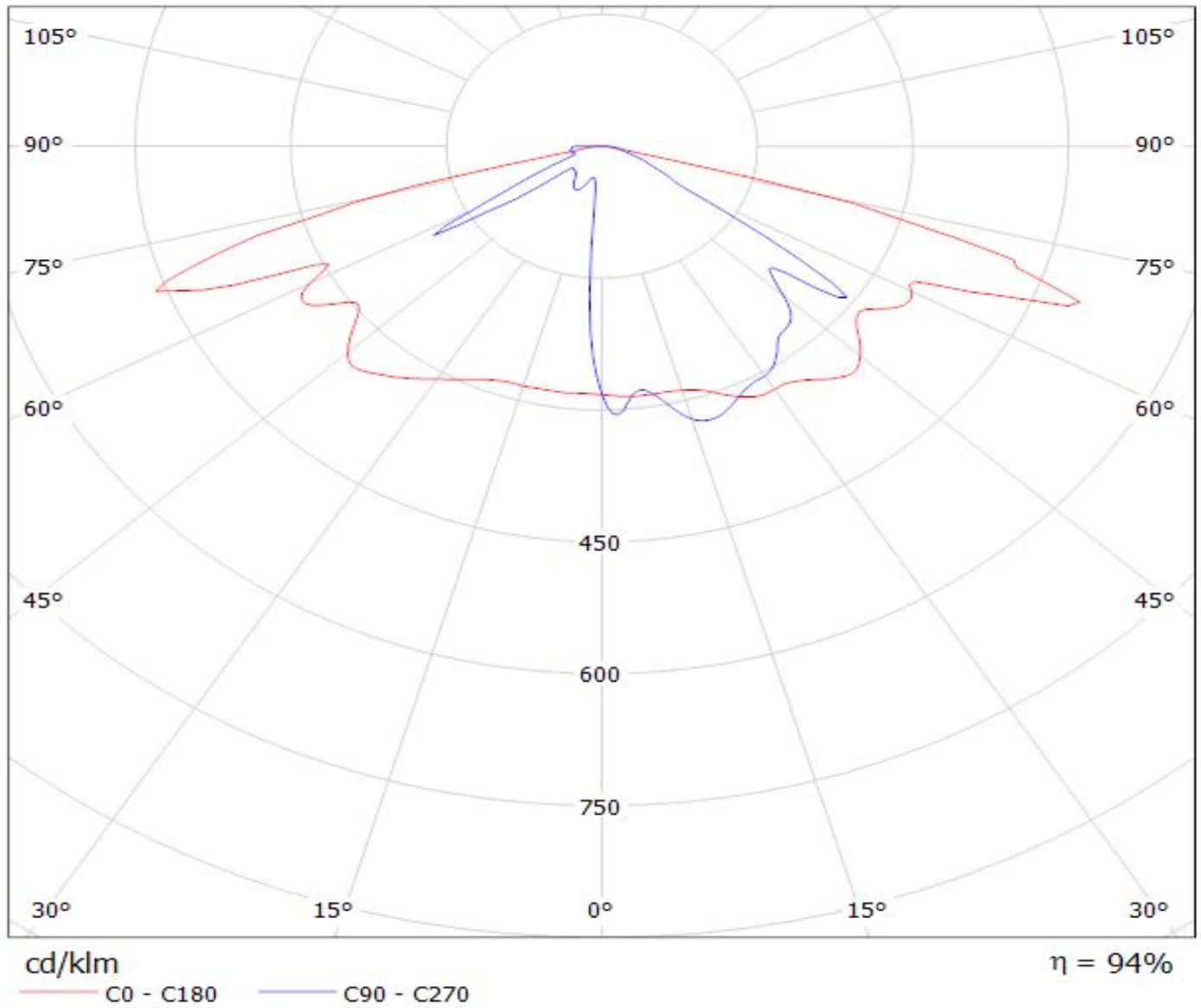

Luminaire: LEDiL Oy C13301_STRADA-2x2-T3_(XP-L)

Lamps: 1 x CREE_XP-L_2x2_(XPLAWT-0-1B0-V40-00-0001)_514lm@250mA_CCT=7600K_P=2.79963W_I=249.9mA

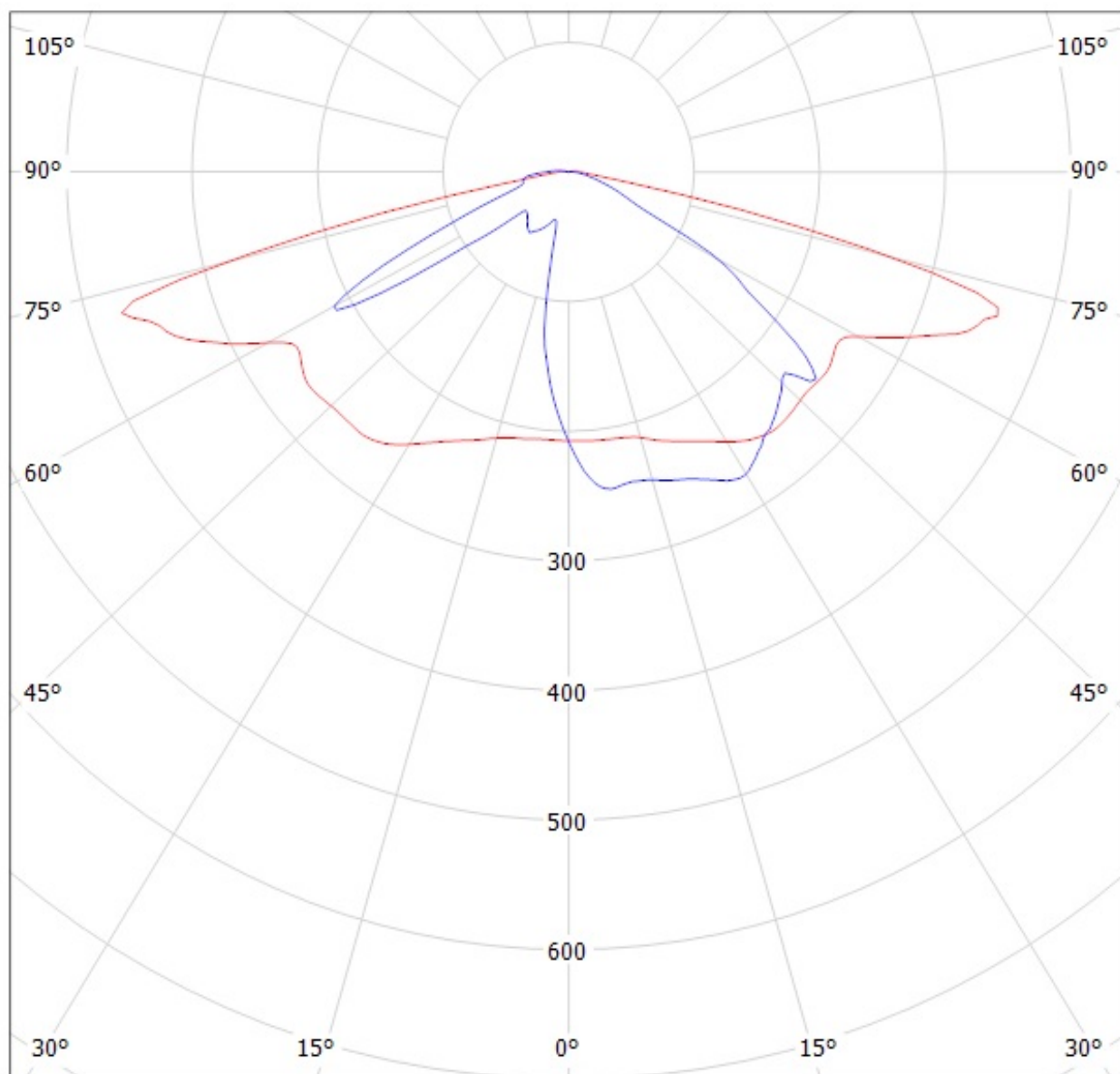

cd/klm

— C0 - C180 — C90 - C270

$\eta = 94\%$

Luminaire: LEDiL Oy C13301_STRADA-2X2-T3_(XP-L_HI)
Lamps: 1 x Cree_XP-L_HI_(2x2)_(XPLAWT-H-5A3-U60-013-0001)
_455.077lm@250mA_P=2.84011W_I=0,2499A

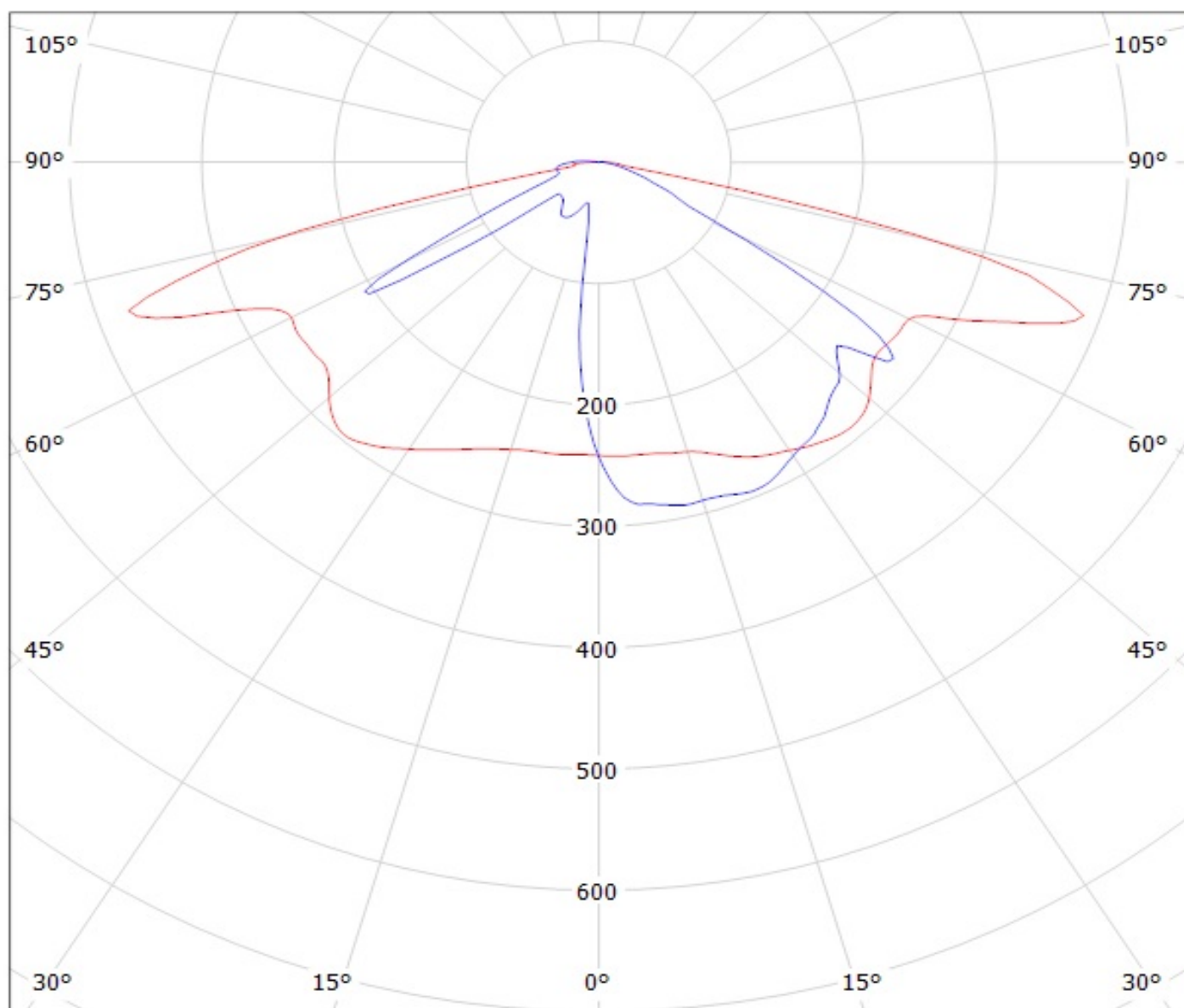

cd/klm

— C0 - C180 — C90 - C270

$\eta = 96\%$

Luminaire: Ledil C13301_STRADA-2X2-T3_(XP-L2)

Lamps: 1 x Cree_XP-L2_2x2_(XPLBWT-00-0000-000BV50E3)550.93lm@250mA_P=2.7815W_I=0.25A

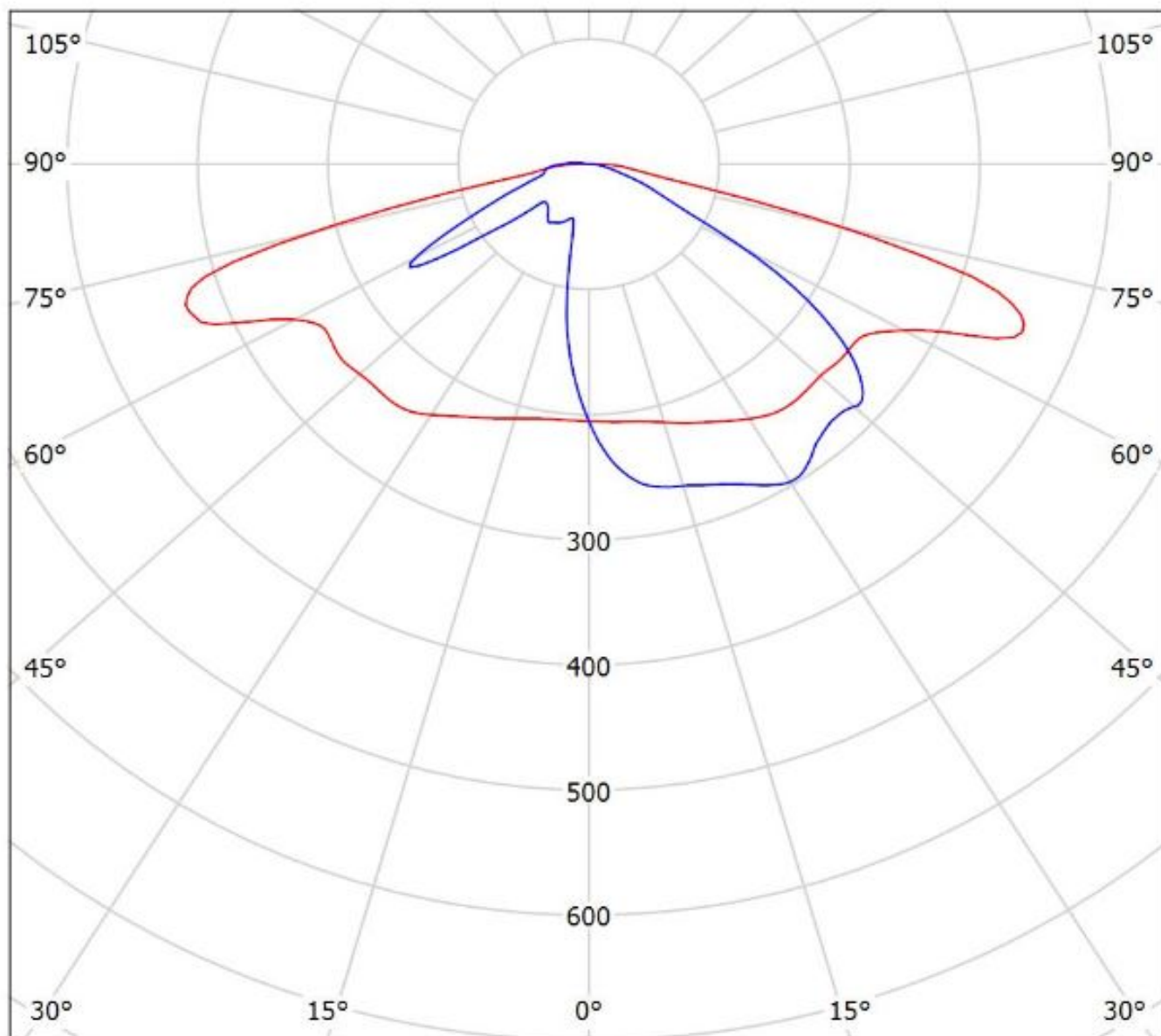

cd/klm

— C0 - C180

— C90 - C270

$\eta = 97\%$

Luminaire: Ledil Oy C13301_STRADA-2X2-T3_(XP-G3)_SIMULATED
Lamps: 1 x Cree XP-G3

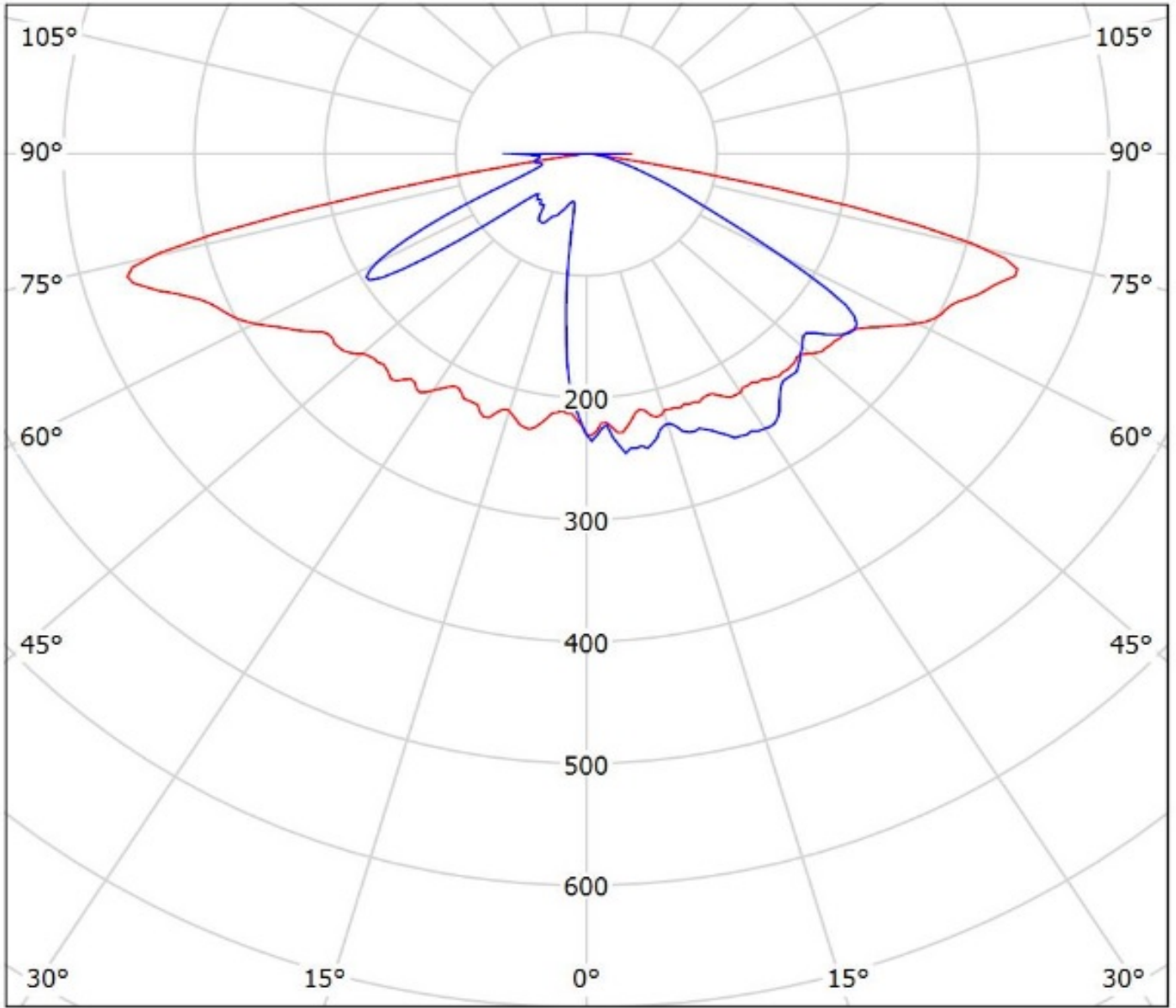

cd/klm

— C0 - C180 — C90 - C270

$\eta = 93\%$

Luminaire: Ledil C13301_STRADA-2X2-T3_(XD16)

Lamps: 1 x Cree_XD16_2x2_(XD16AWT-H-2B0-S20-0B-002)_453.677lm@250mA_CCT=5700K_P=2.78289W_I=0.25A

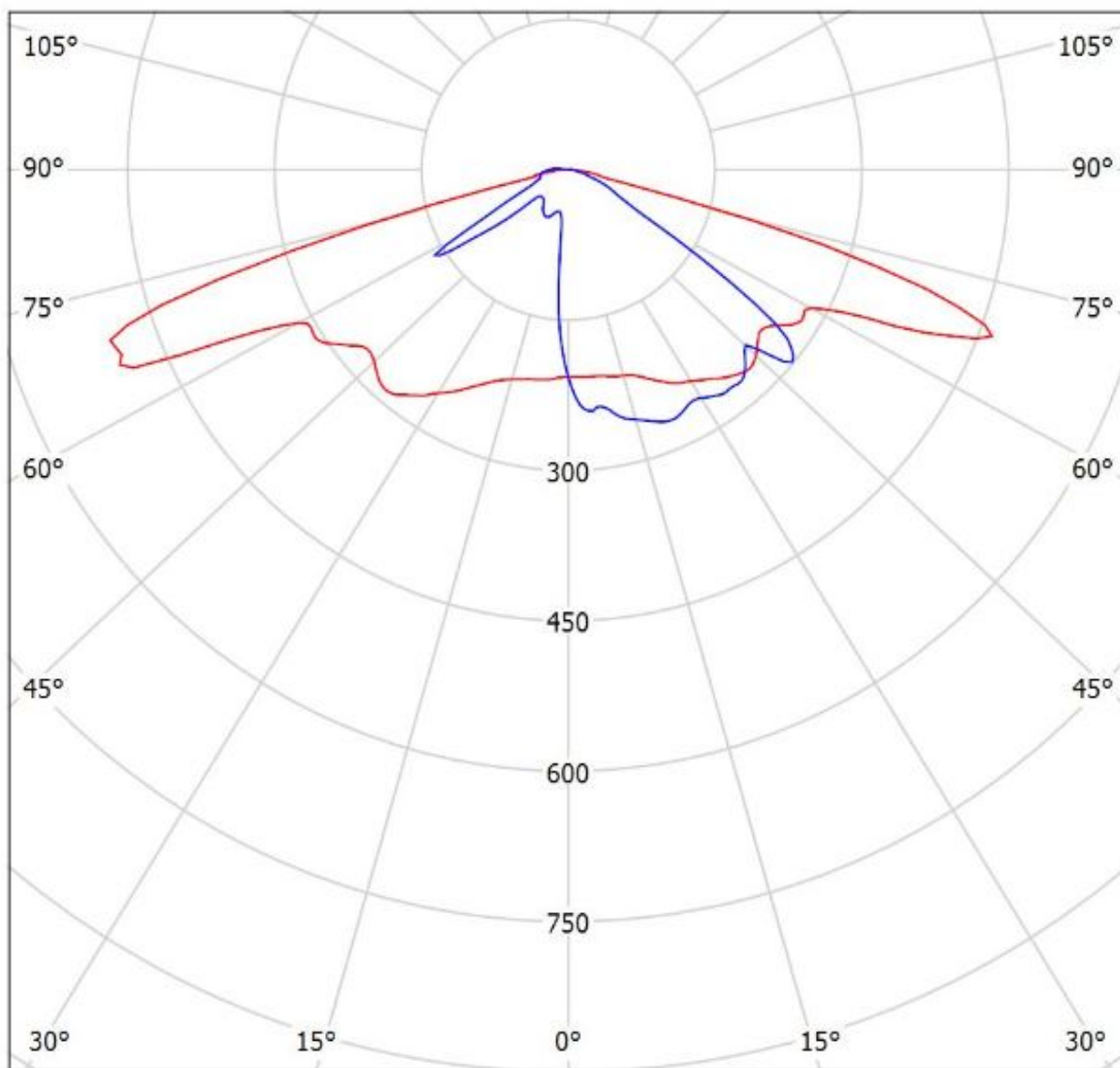

cd/klm

— C0 - C180 — C90 - C270

$\eta = 95\%$

Luminaire: LEDiL Oy C13301_STRADA-2X2-T3_(XD16_Cluster16)

Lamps: 1 x Cree_XD16_2x2cluster_(XD16AWT-H-2B0-S20-0B-002)_1763.39lm@250mA_CCT=5700K_P=10.926W_U=43.738V

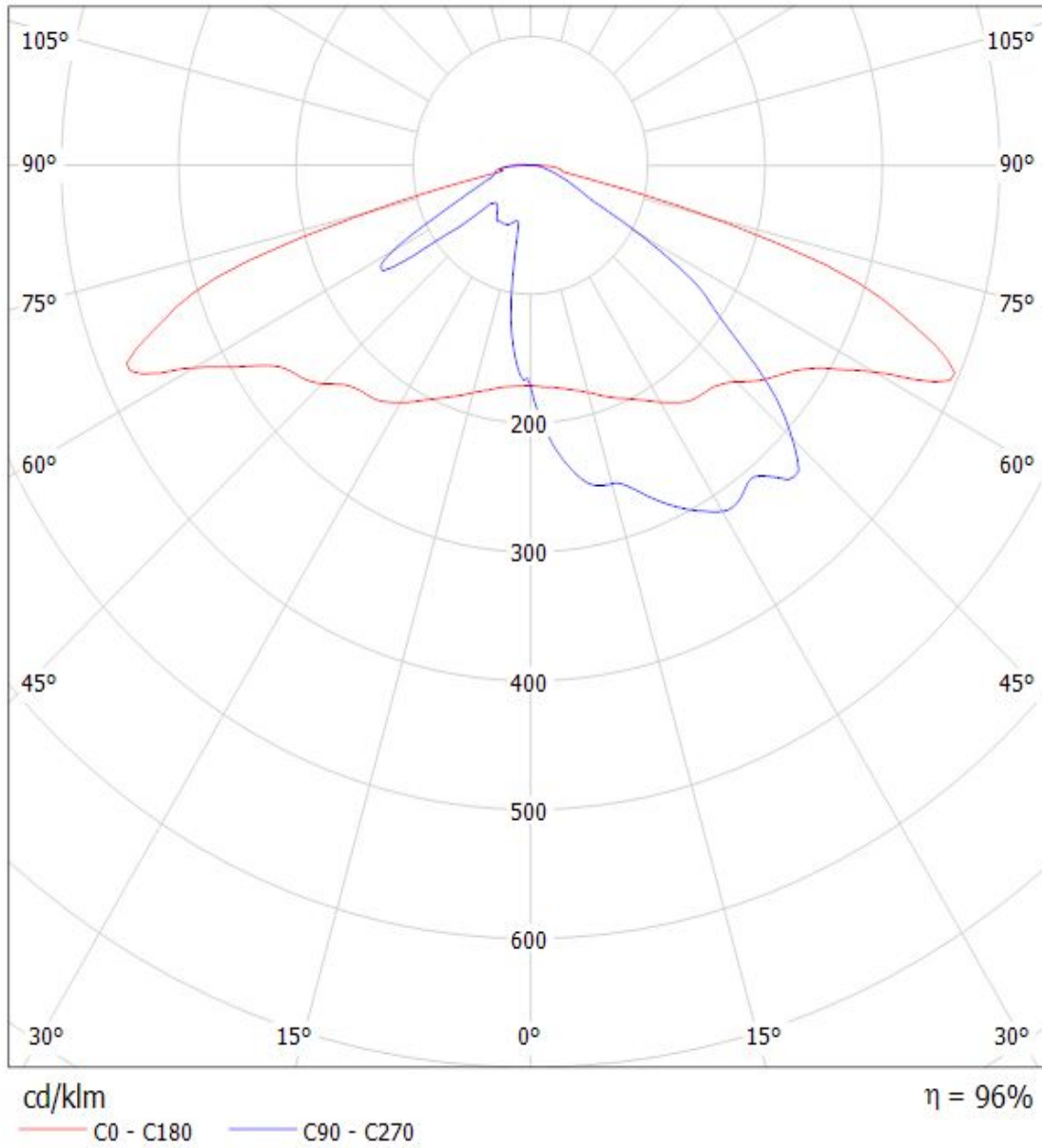

LEDiL Oy C13301_STRADA-2X2-T3_(LG_3535) Eff.94.4% / LDC (Polar)

Luminaire: LEDiL Oy C13301_STRADA-2X2-T3_(LG_3535) Eff.94.4%

Lamps: 1 x LG_3535_Ceramic_2x2 (374lm@250mA)

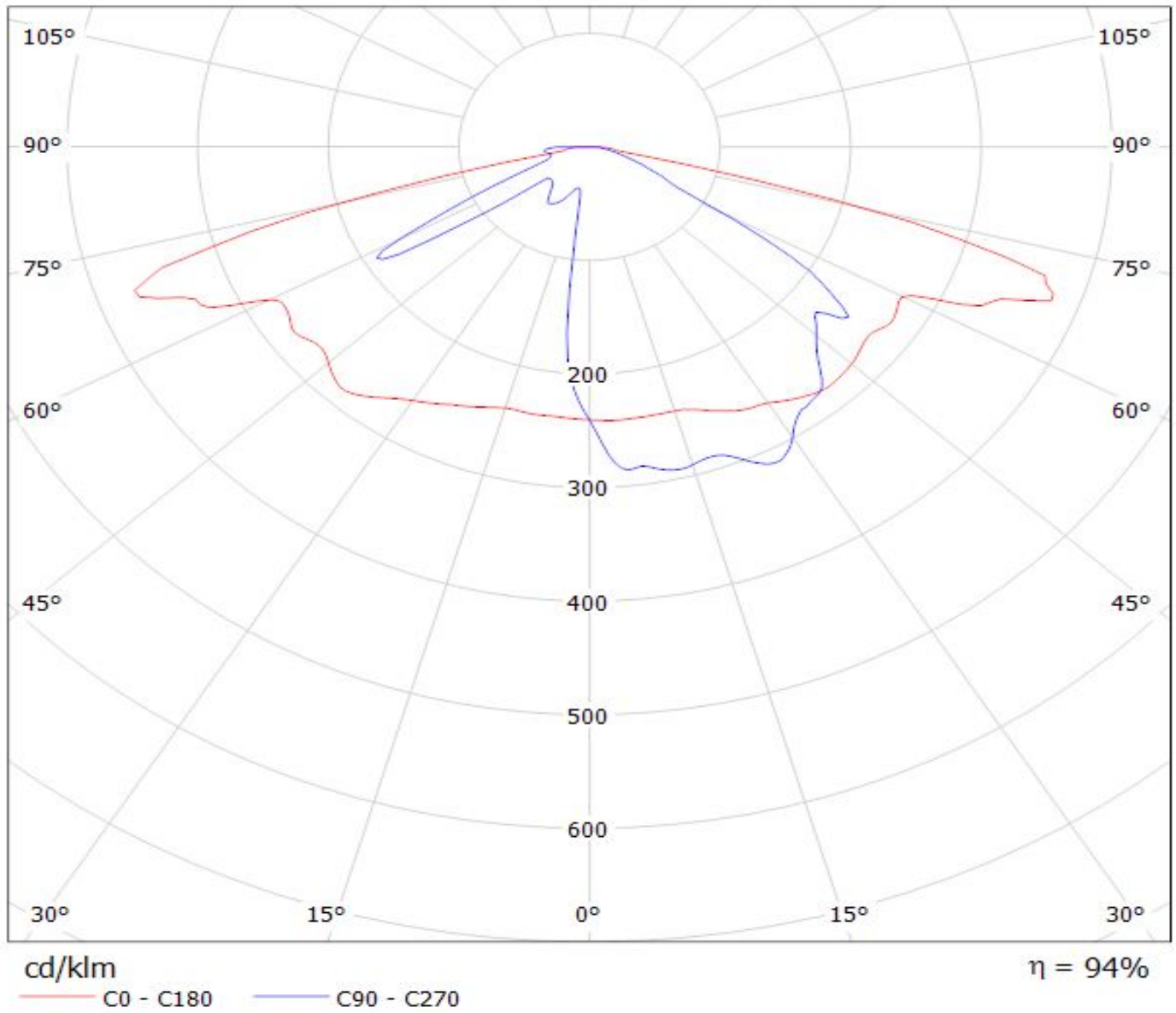

**LEDiL Oy C13301_STRADA-2X2-T3_(LG-3535-CERAMIC-GEN2) Eff.94.0% / LDC
(Polar)**

Luminaire: LEDiL Oy C13301_STRADA-2X2-T3_(LG-3535-CERAMIC-GEN2) Eff.94.0%
Lamps: 1 x LG-3535-CERAMIC-GEN2_2x2_475.25lm@250mA_P=2.8651W_CCT=6562K_I=249.9mA

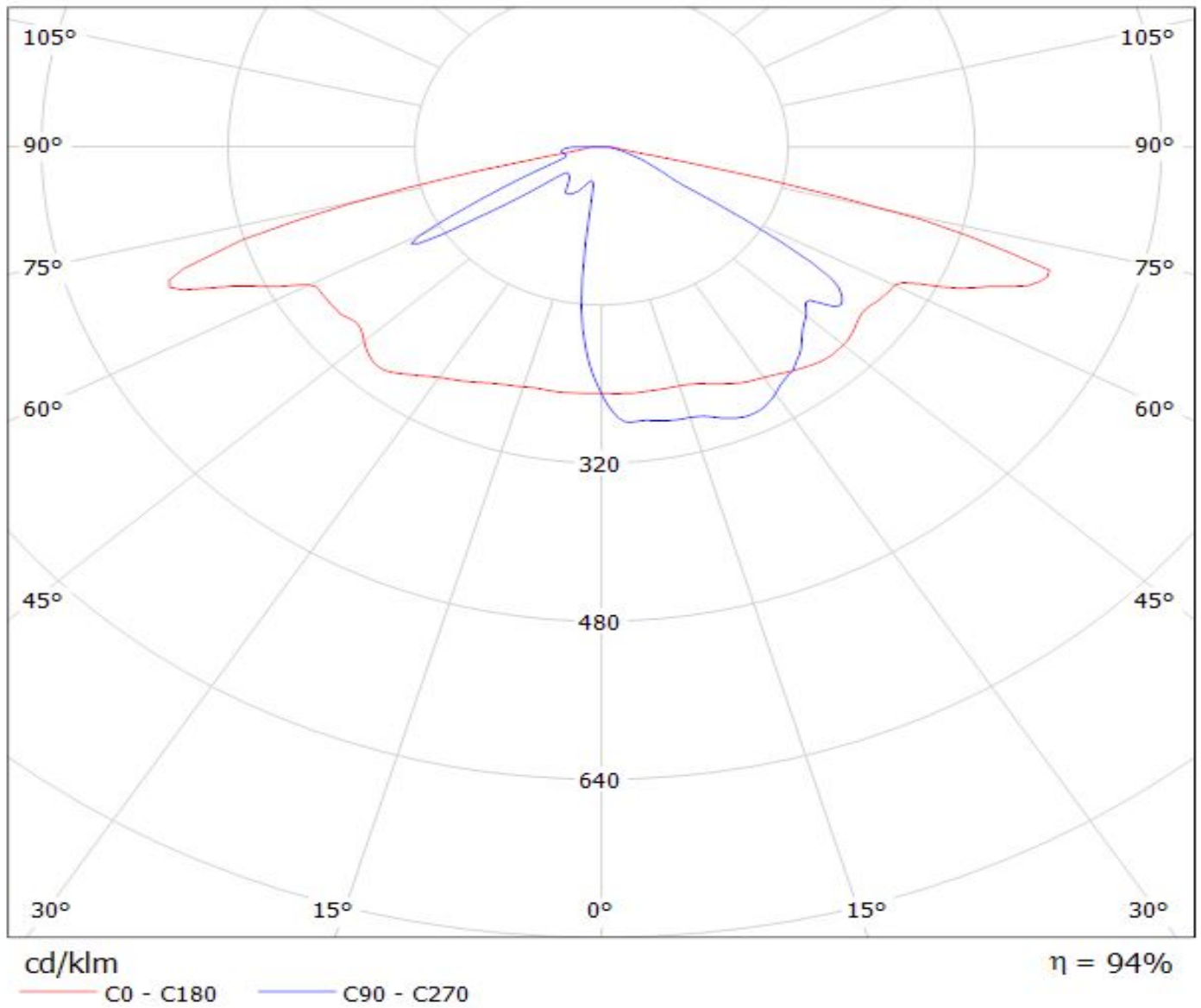

LEDiL Oy C13301_STRADA-2x2-T3_(LUXEON_T) Eff.93.9% / LDC (Polar)

Luminaire: LEDiL Oy C13301_STRADA-2x2-T3_(LUXEON_T) Eff.93.9%

Lamps: 1 x LUXEON_T (294lm@250mA)

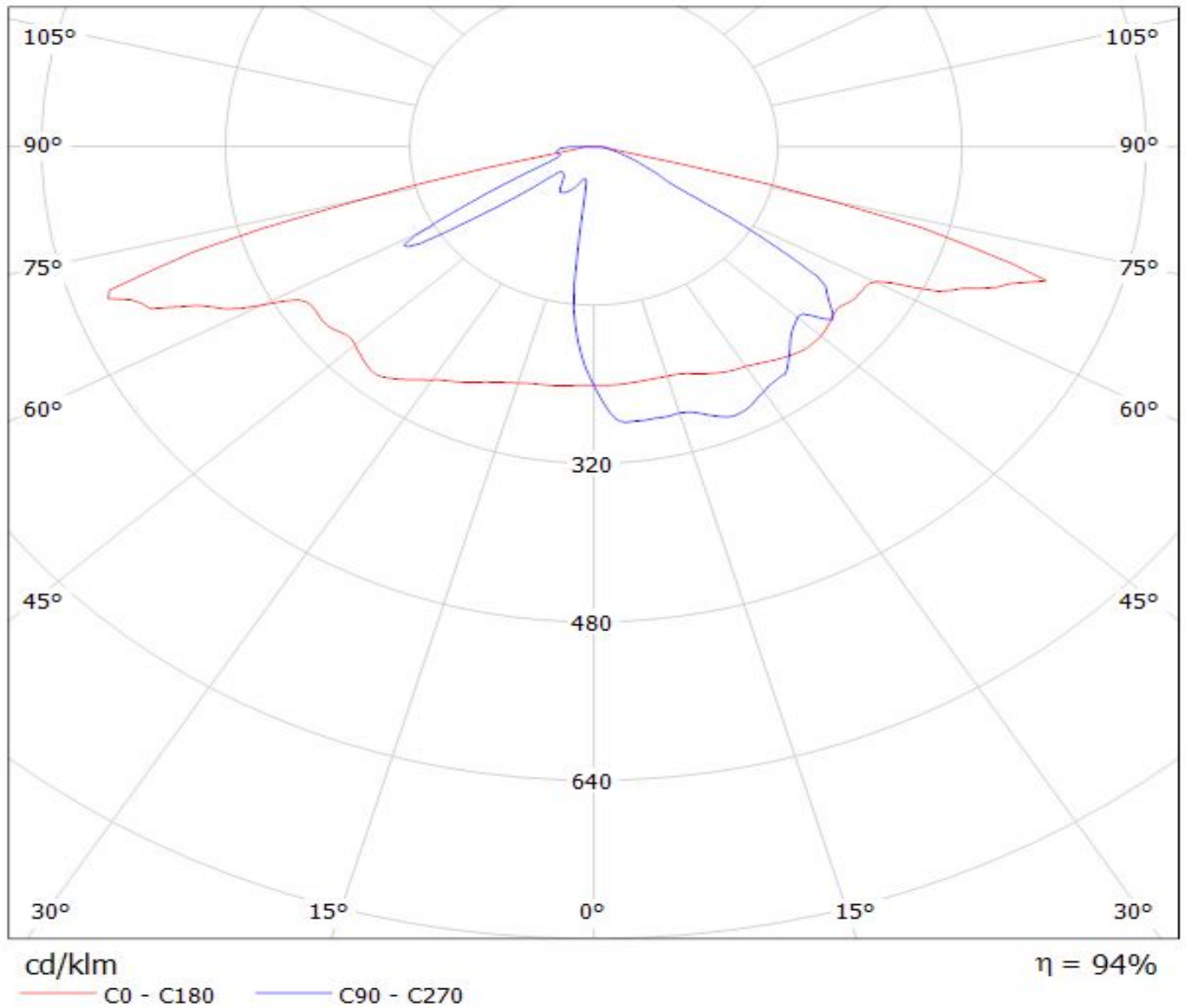

LEDiL Oy C13301_STRADA-2X2-T3_(Rebel-ES) Eff.94.1% / LDC (Polar)

Luminaire: LEDiL Oy C13301_STRADA-2X2-T3_(Rebel-ES) Eff.94.1%

Lamps: 1 x Rebel-ES (341lm@250mA)

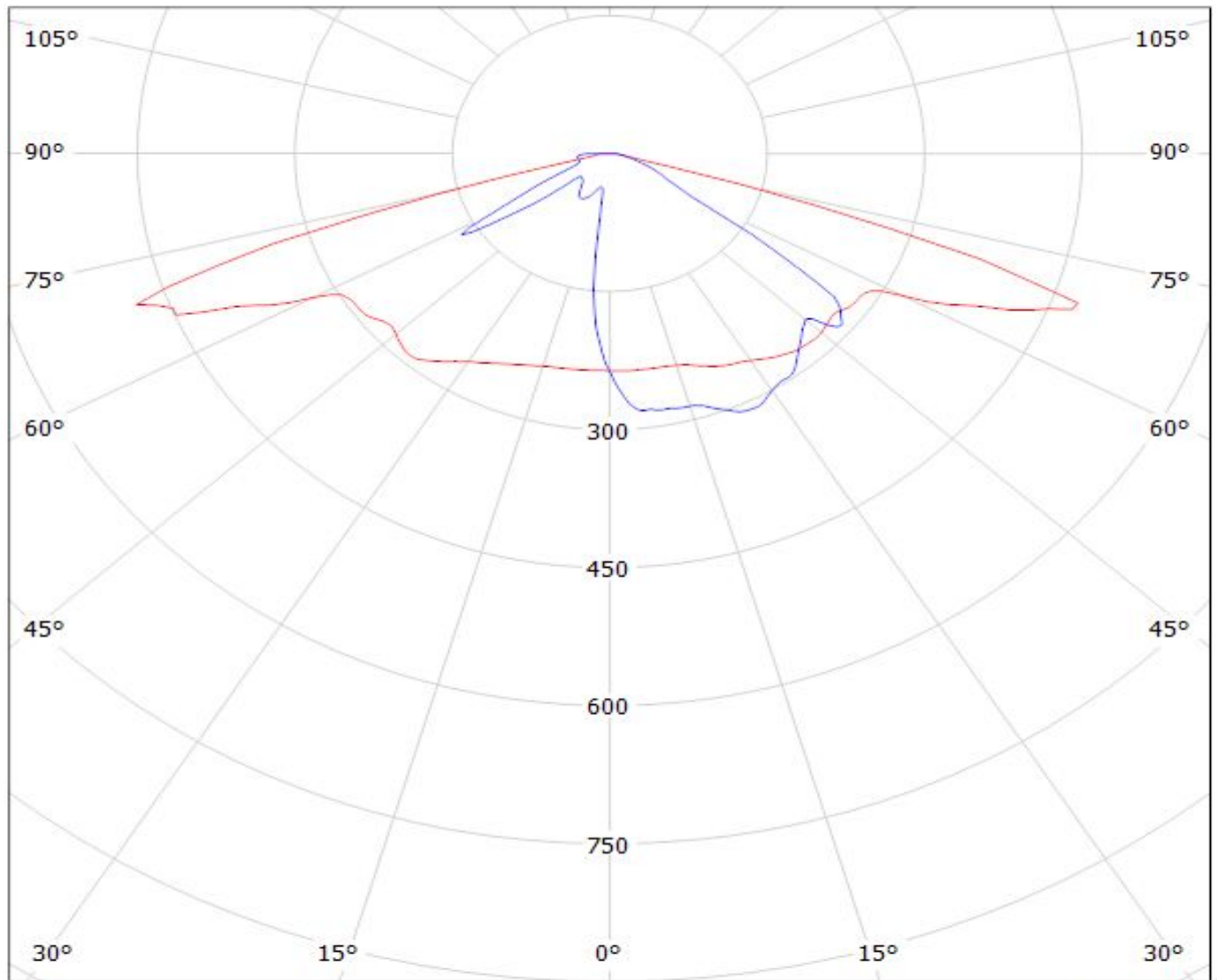

cd/klm

η = 94%

— C0 - C180

— C90 - C270

LEDiL Oy C13300_STRADA-2X2-T2_(LUXEON_R) Eff.94.4% / LDC (Polar)

Luminaire: LEDiL Oy C13300_STRADA-2X2-T2_(LUXEON_R) Eff.94.4%

Lamps: 1 x LUXEON_R (315lm@250mA)

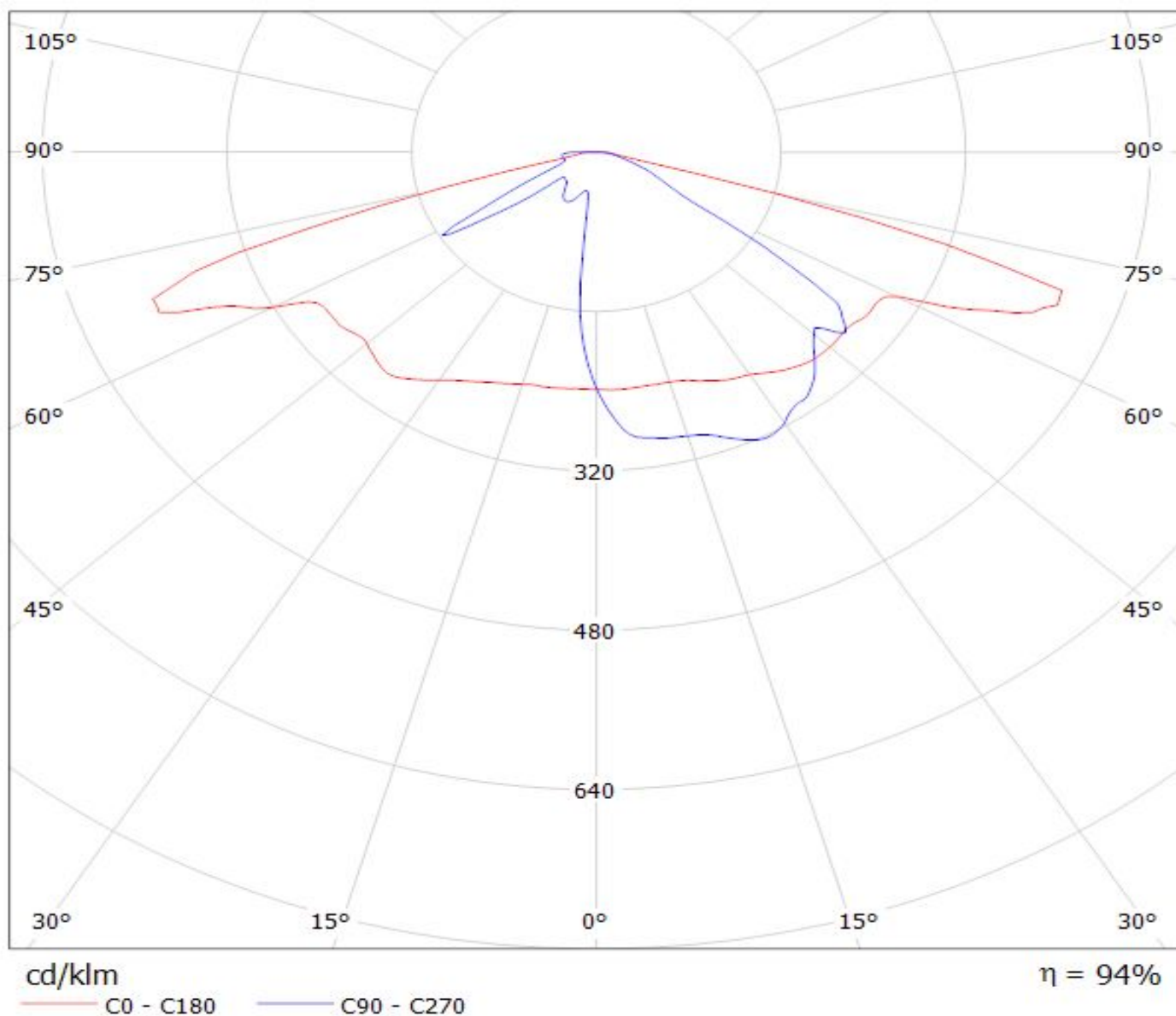

Luminaire: LEDiL Oy C13301_STRADA-2X2-T3_(Luxeon-Z-ES) Eff. 94%
Lamps: 1 x Luxeon Z ES 2x2 (LXZ2-3090) 209.277lm@250mA_P=2.81W_I=0.2499A

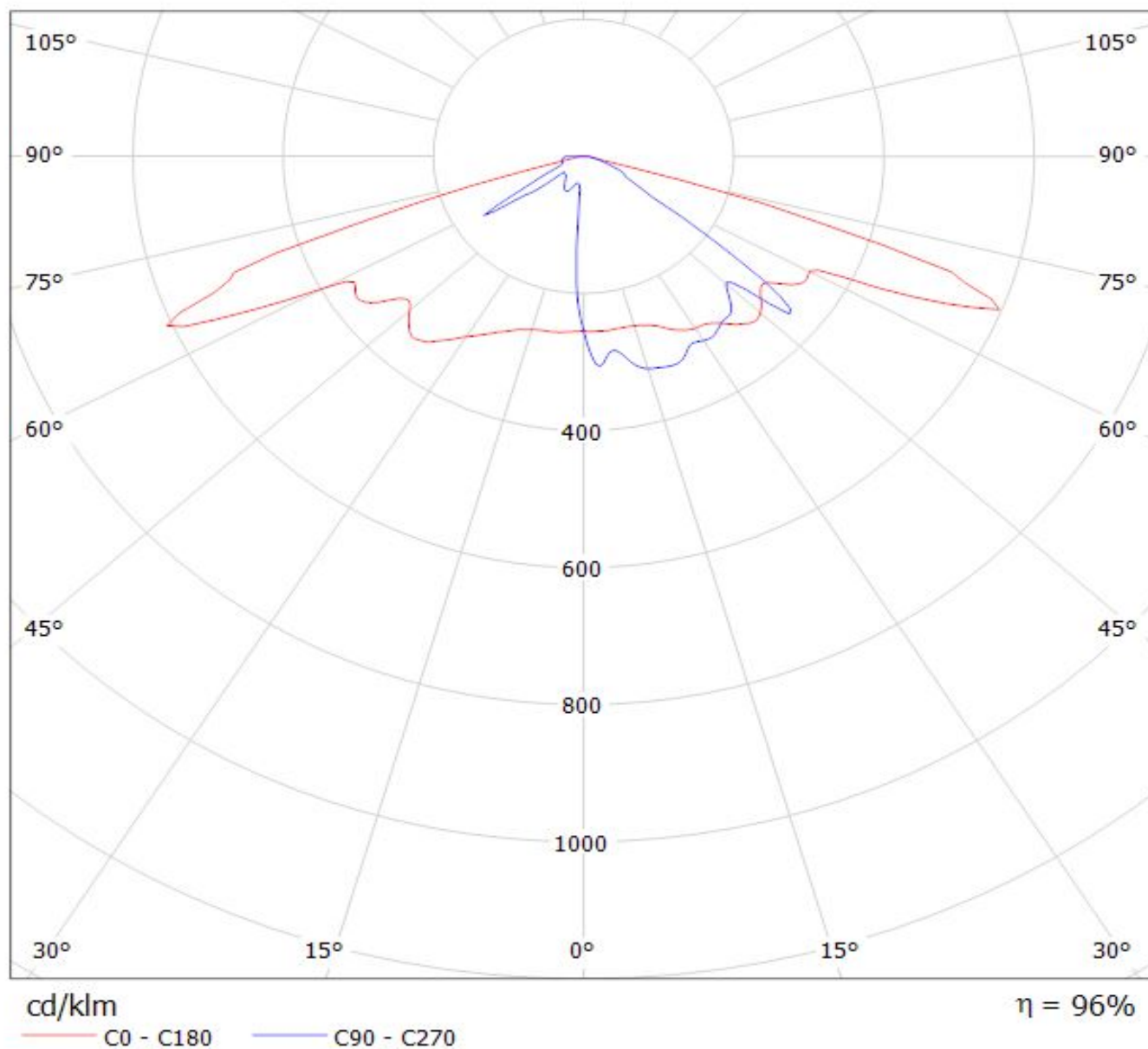

Luminaire: LEDiL Oy C13301_STRADA-2X2-T3_(LUXEON_Q) Eff.96.0%

Lamps: 1 x LUXEON_Q_2x2_(LHQ-3080)_299.038lm@250mA_P=2.8742W_I=249.8mA

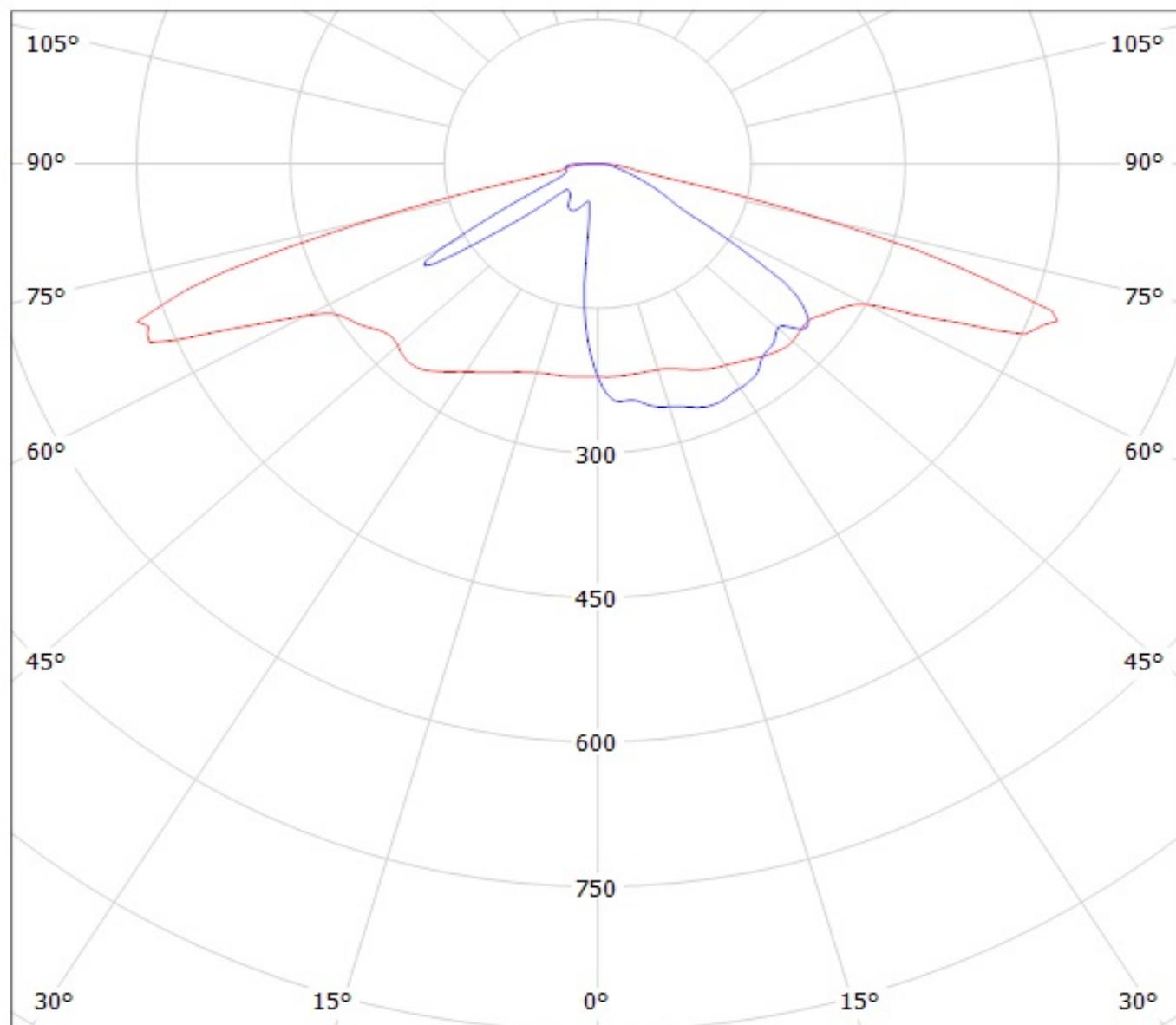

cd/klm

— C0 - C180

— C90 - C270

Luminaire: Ledil C13301_STRADA-2X2-T3_(Luxeon_MZ)

Lamps: 1 x Philips_Lumileds_Luxeon_MZ_(LMZ7-QW57)_(2x2)_427.268lm@250mA_P=2.734W_I=0.2500A

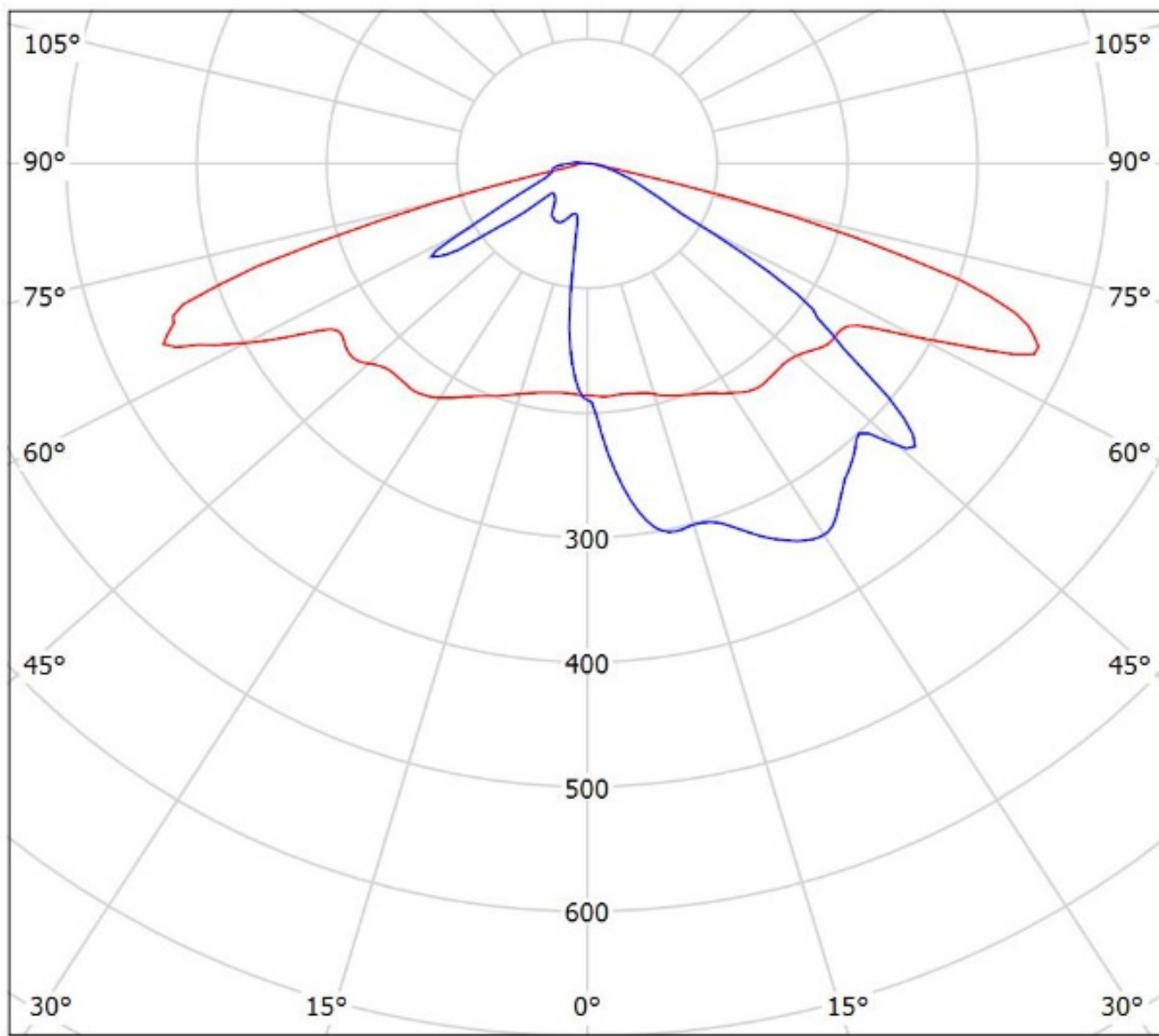

cd/klm

— C0 - C180 — C90 - C270

$\eta = 97\%$

Luminaire: LEDiL Oy C13301_STRADA-2X2-T3_(Luxeon_TX)
Lamps: 1 x Luxeon_TX_2x2_321.384lm@250mA_P=2.79488W_I=249.9mA

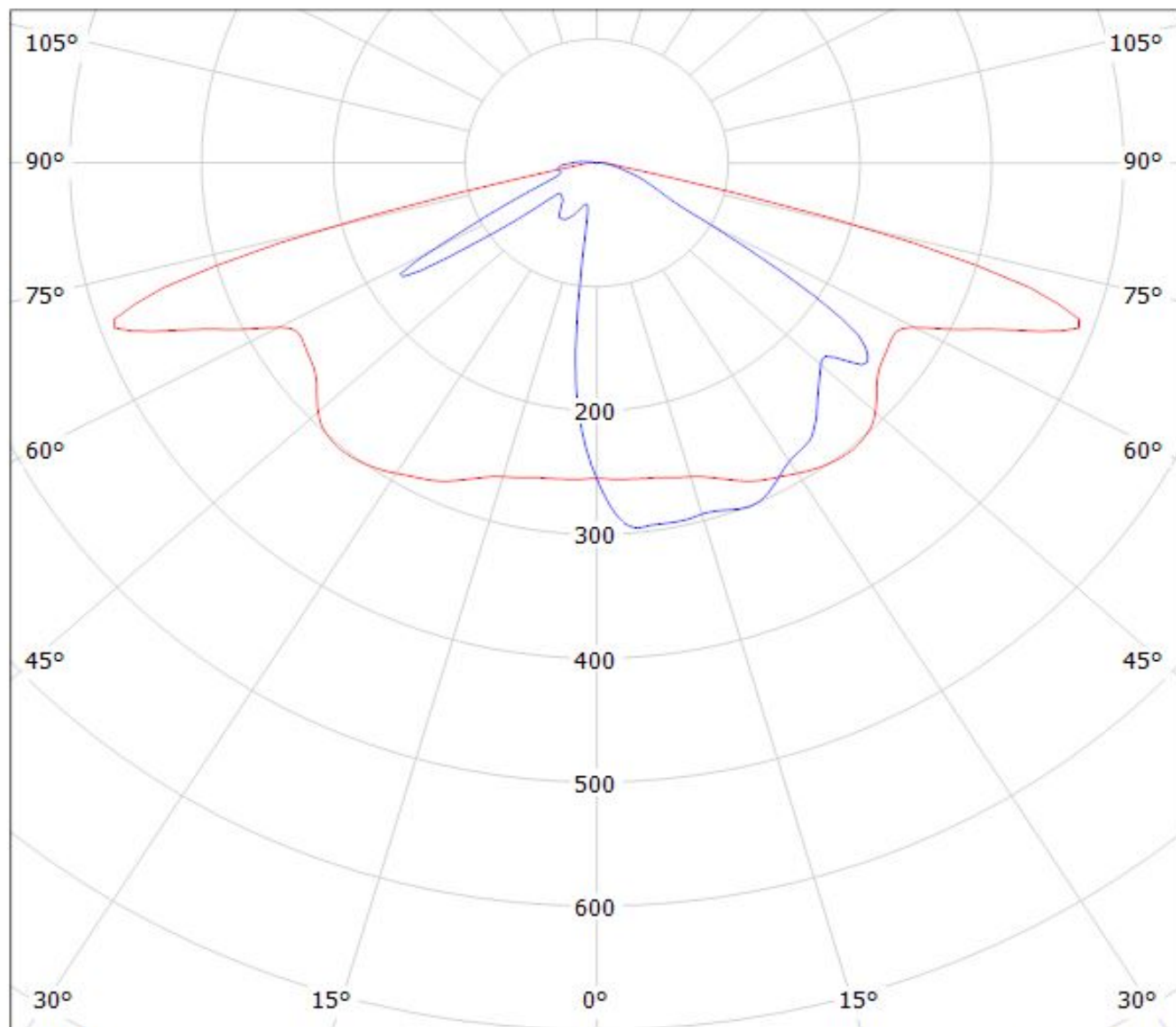

cd/klm

— C0 - C180 — C90 - C270

$\eta = 94\%$

Luminaire: LEDiL Oy C13301_STRADA-2X2-T3_(Luxeon_5050)

Lamps: 1 x Luxeon_5050_2x2_1270.76lm@80mA_CCT=5700K_P=7.35815W_I=0.080A_70CRI

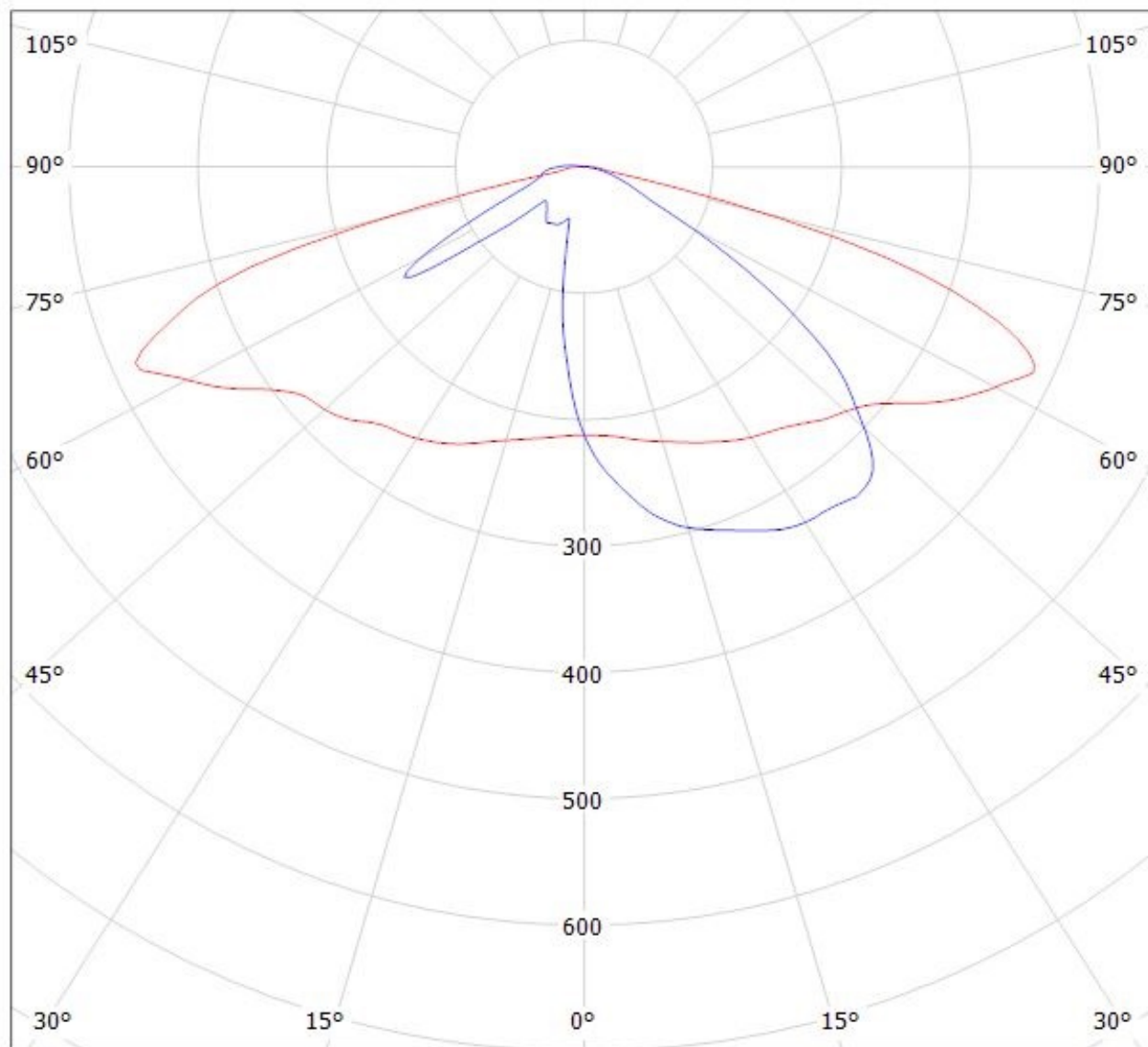

cd/klm

$\eta = 94\%$

— C0 - C180

— C90 - C270

Luminaire: LEDiL Oy C13301_STRADA-2X2-T3_(Luxeon_V)

Lamps: 1 x Lumileds_Luxeon_V_488.501lm@250mA_CCT=4000K_P=2.75155W_I=0.250A

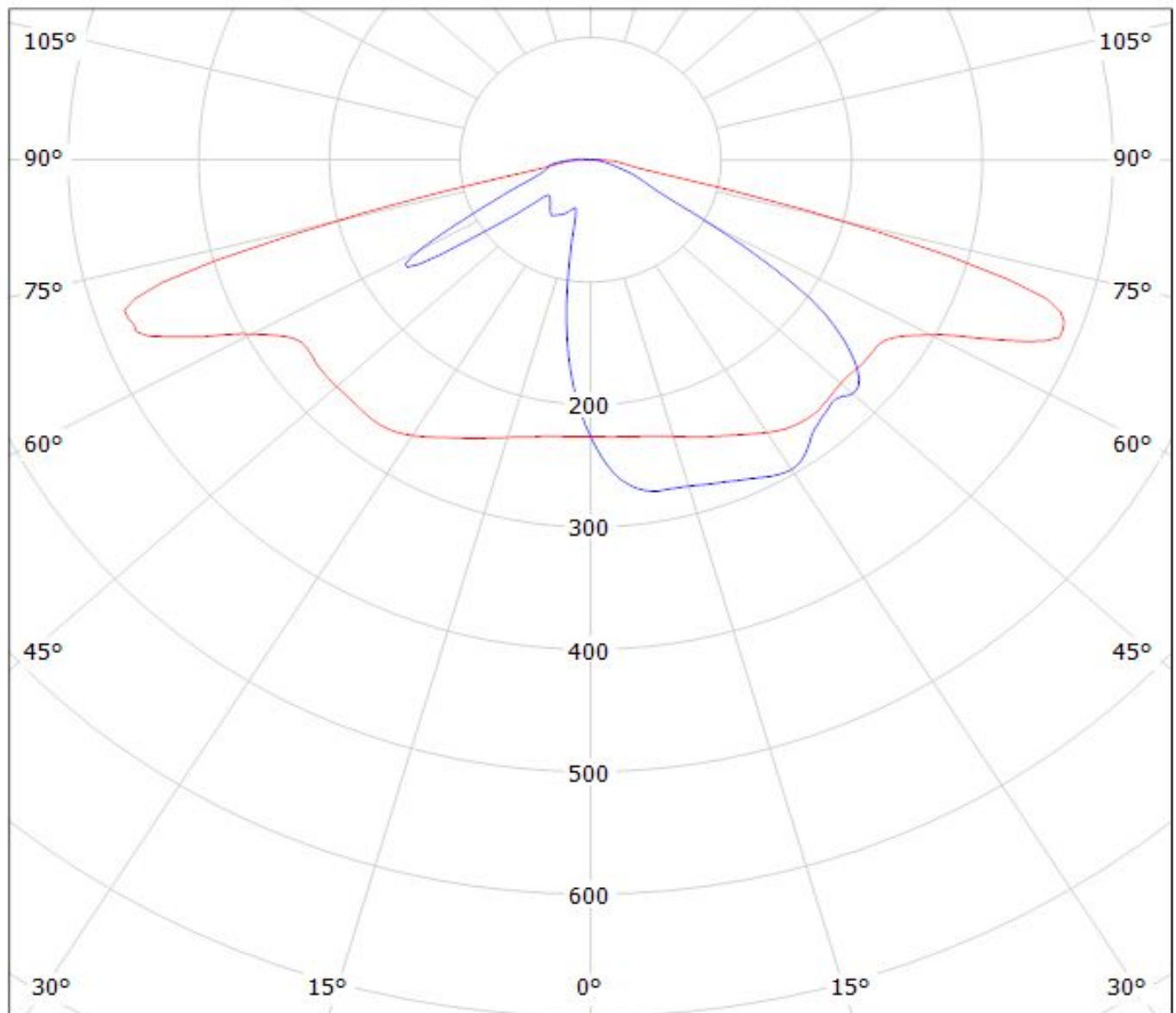

cd/klm

— C0 - C180

— C90 - C270

$\eta = 96\%$

LEDiL Oy C13301_STRADA-2X2-T3_(Nichia_219B) Eff.94.4% / LDC (Polar)

Luminaire: LEDiL Oy C13301_STRADA-2X2-T3_(Nichia_219B) Eff.94.4%

Lamps: 1 x Nichia_219B (310lm@250mA)

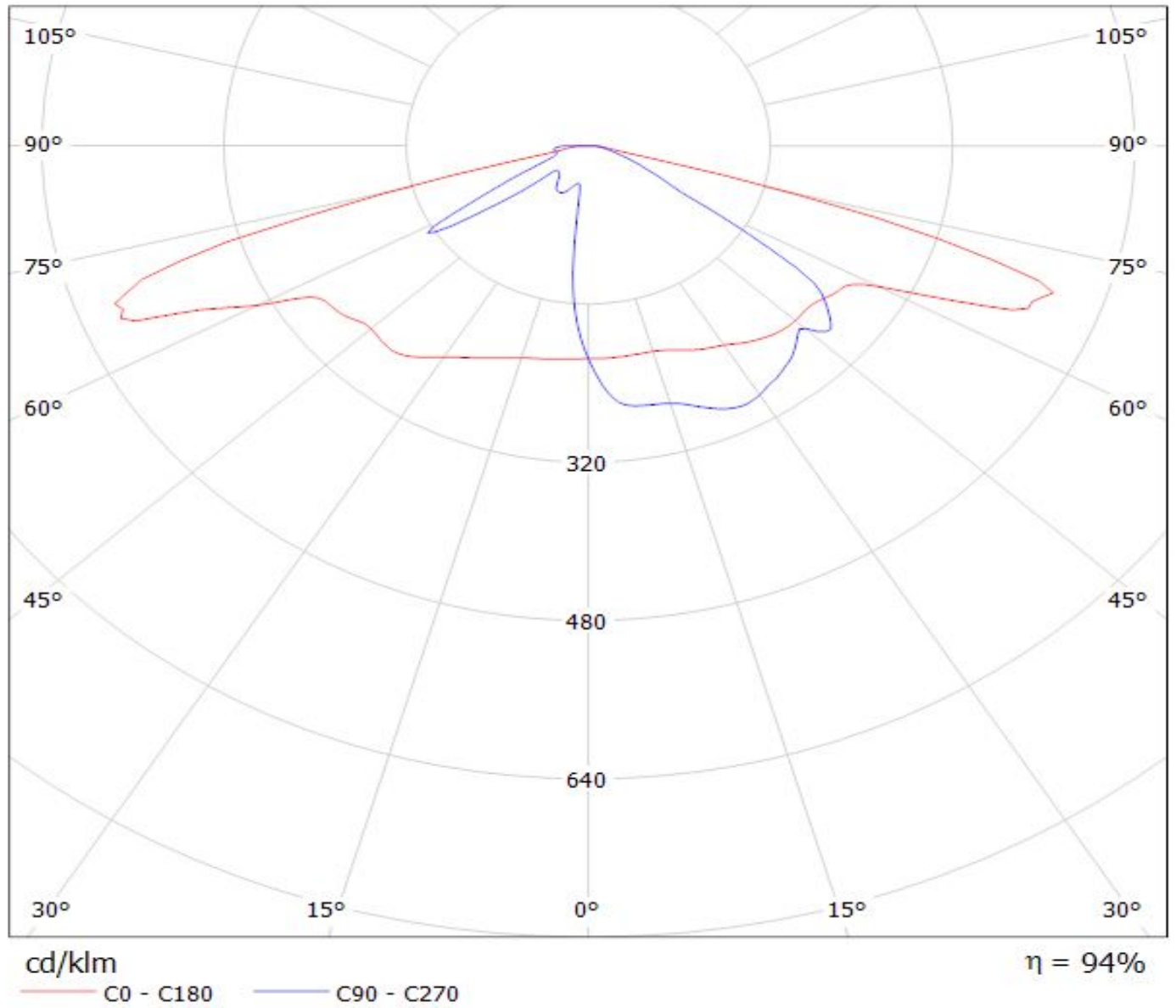

LEDiL Oy C13301_STRADA-2x2-T3_(N383) Eff.95.9% / LDC (Polar)

Luminaire: LEDiL Oy C13301_STRADA-2x2-T3_(N383) Eff.95.9%

Lamps: 1 x NICHIA_NS9x383 (287.074lm@250mA)

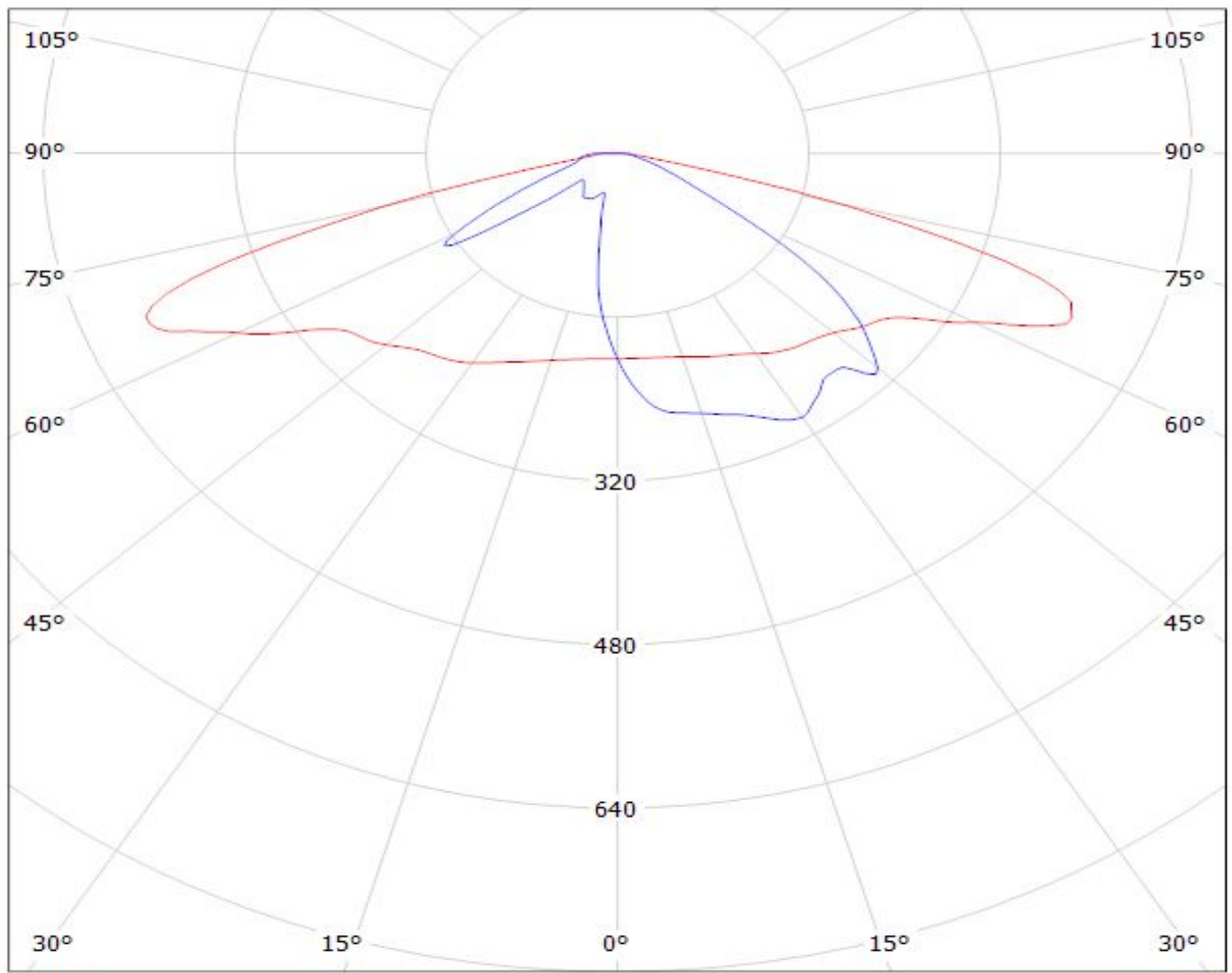

— C0 - C180 — C90 - C270

Luminaire: LEDiL Oy C13301_STRADA-2X2-T3_(NWSL229AE)

Lamps: 1 x Nichia_2X2_NWSL229AE_476.548lm@250mA_P=2.7515W_I=0.250A

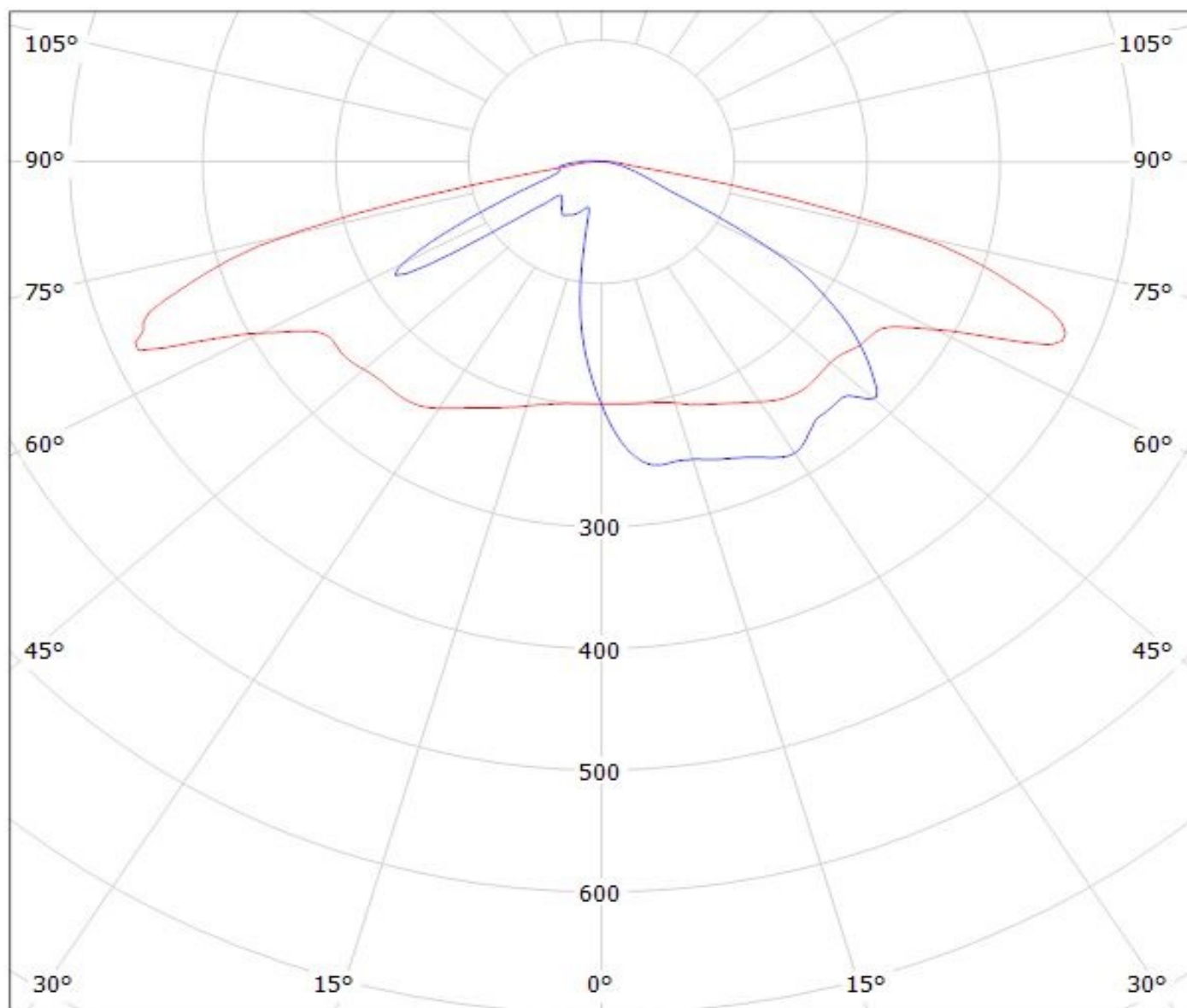

cd/klm

— C0 - C180

— C90 - C270

$\eta = 94\%$

Luminaire: Ledil C13301_STRADA-2X2-T3_(NVSW319AE)
Lamps: 1 x Nichia_NVSW319AE_(sm405D440f2L2R70)

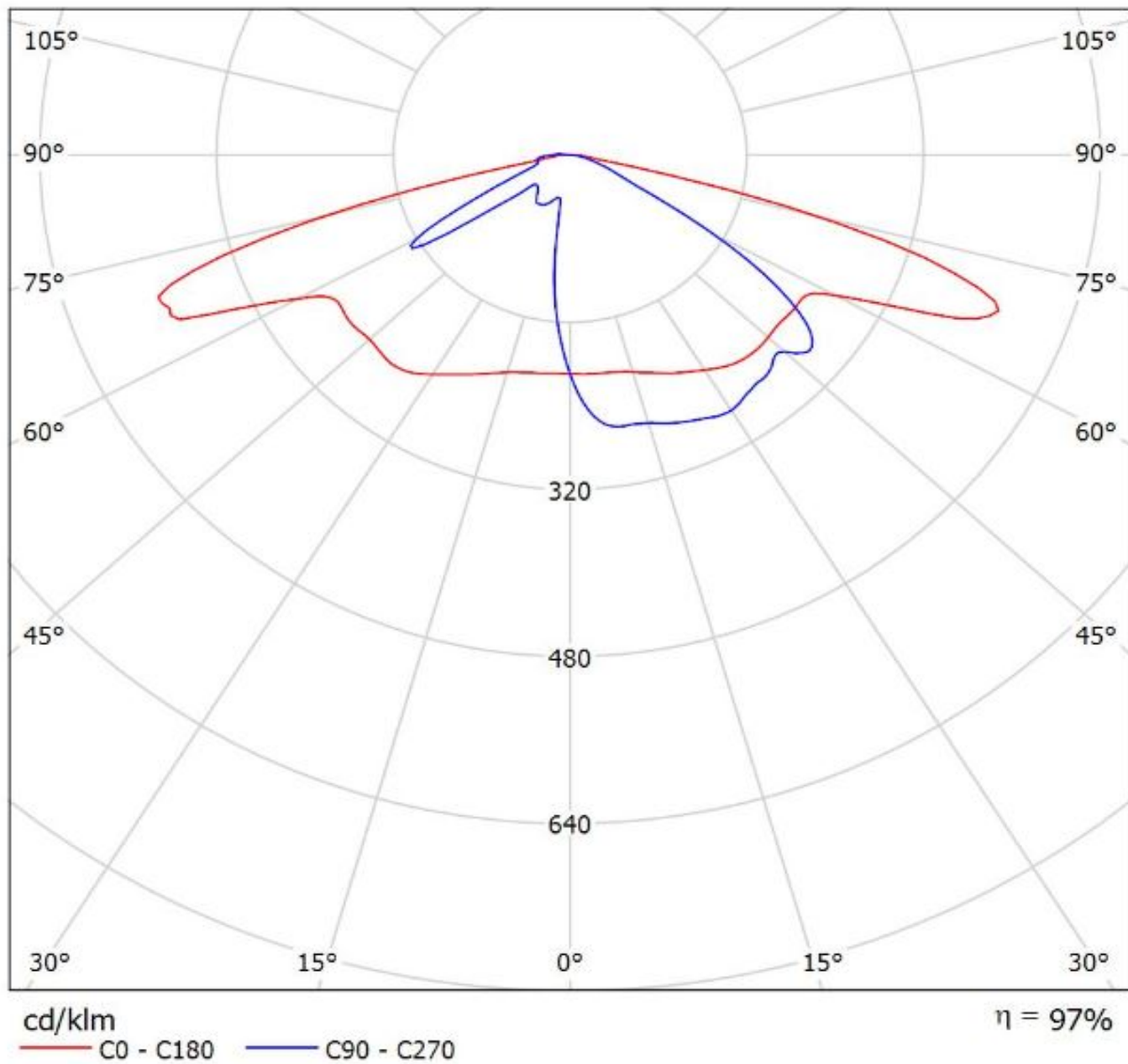

Luminaire: LEDiL Oy C13301_STRADA-2X2-T3_(E21A)

Lamps: 1 x Nichia_E21A_2x2_451.527lm@250mA_P=2.8055W_I=0.250A

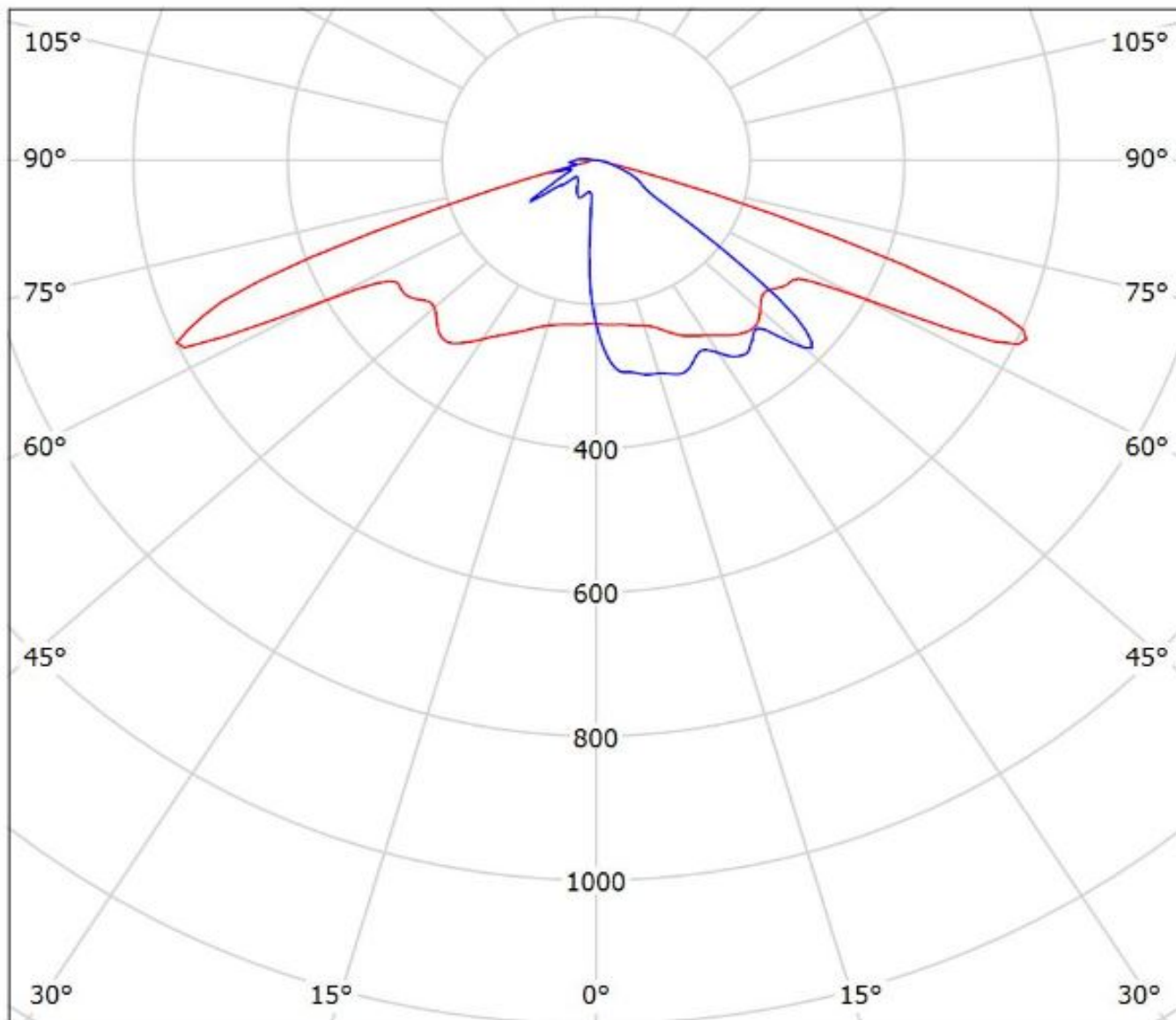

cd/klm

— C0 - C180 — C90 - C270

$\eta = 97\%$

Luminaire: Ledil C13301_STRADA-2X2-T3_(NVSxx19C)

Lamps: 1 x NICHIA_NVsxx19C_2x2_(NVSL219CE)_417.172lm@250mA_P=2.8W_I=0.25A

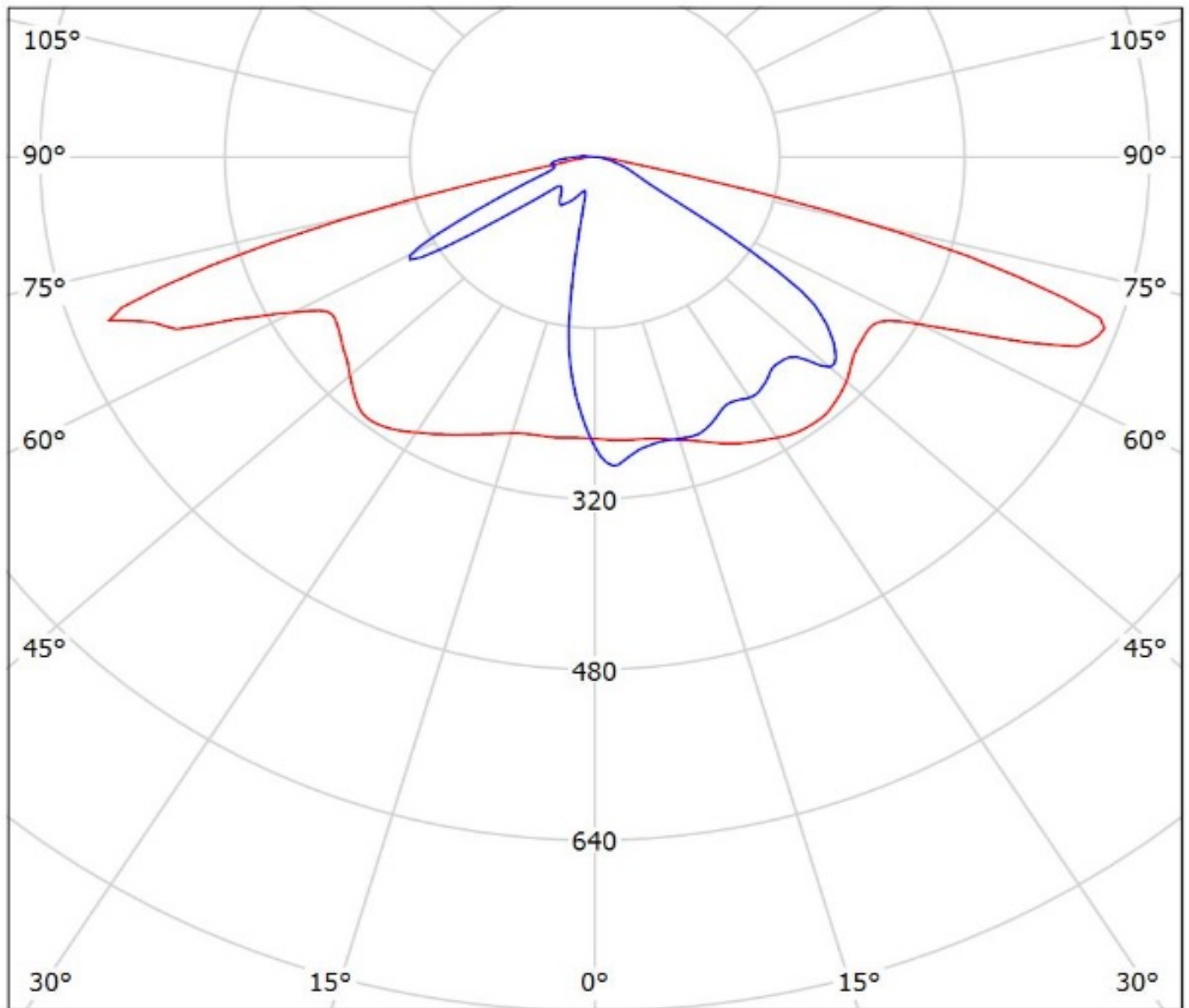

cd/klm

— C0 - C180 — C90 - C270

$\eta = 96\%$

Luminaire: LEDiL Oy C13301_STRADA-2X2-T3_(NVSW219D)

Lamps: 1 x Nichia_NVSW219D_516.635lm@250mA_P=2.82399W_CCT=4000K_I=0.250A

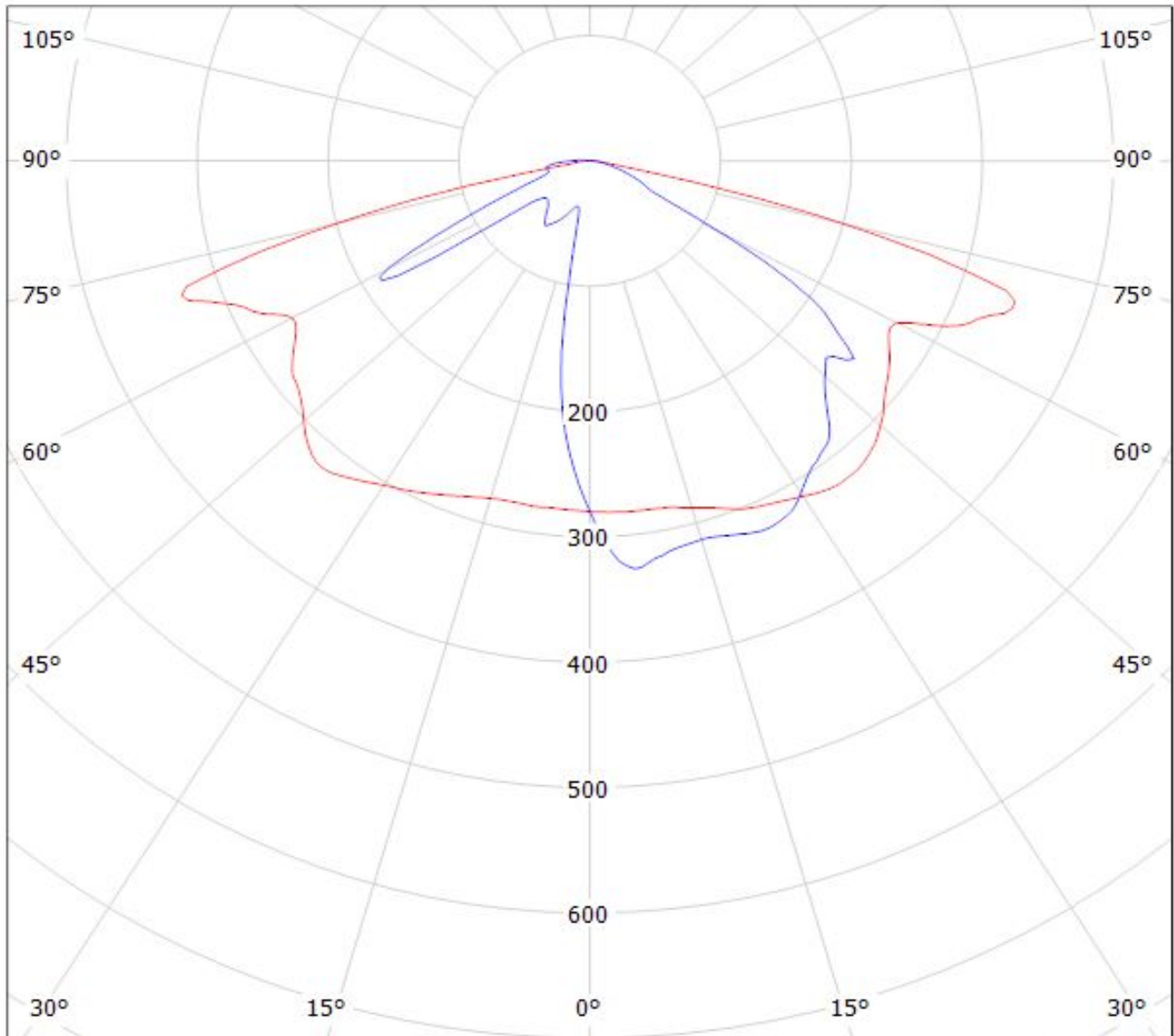

cd/klm

$\eta = 97\%$

— C0 - C180

— C90 - C270

LEDiL Oy C13301_STRADA-2X2-T3_(SQ-PC) Eff.94.3% / LDC (Polar)

Luminaire: LEDiL Oy C13301_STRADA-2X2-T3_(SQ-PC) Eff.94.3%

Lamps: 1 x Oslon Square PC (399lm@250mA)

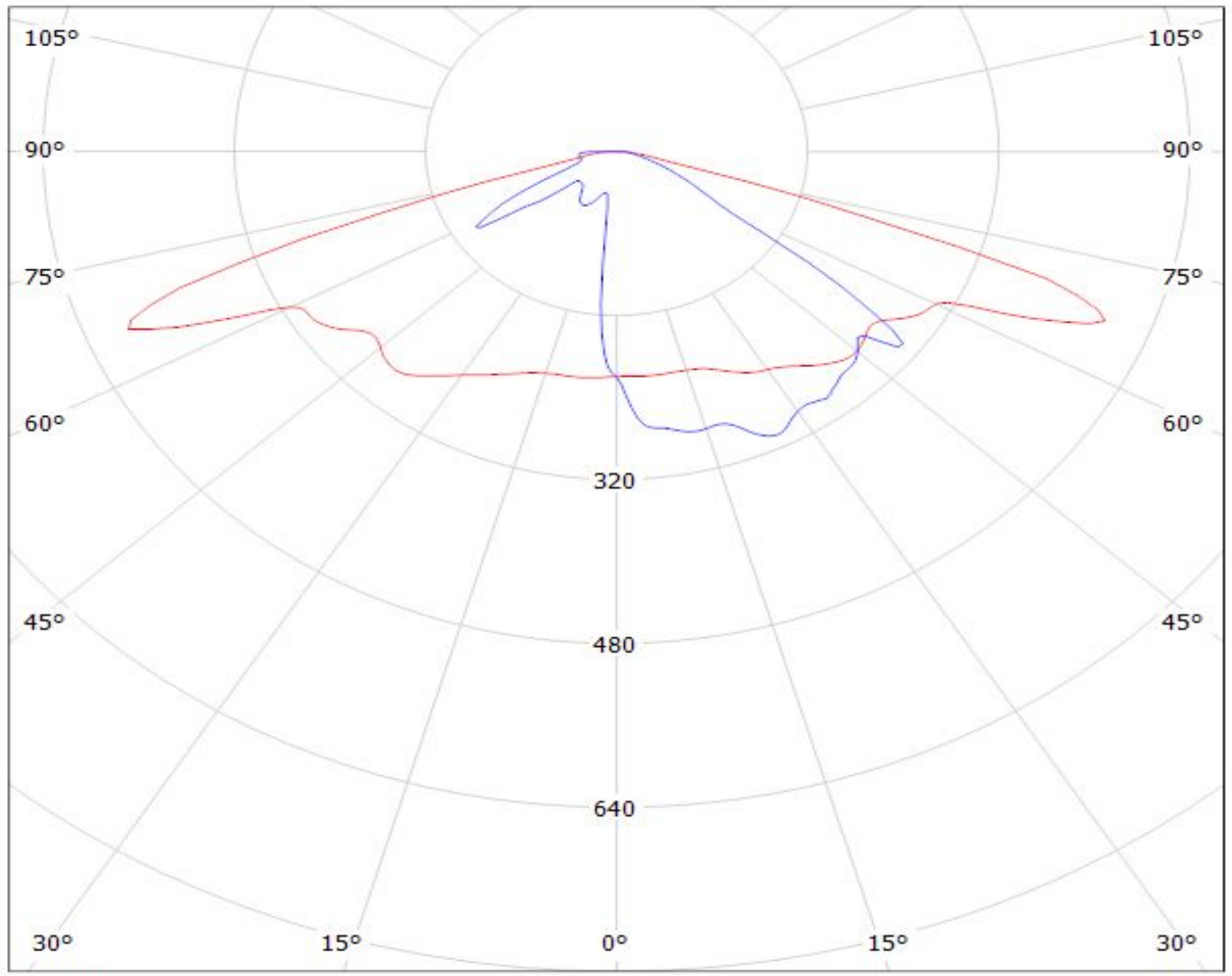

cd/klm

— C0 - C180

— C90 - C270

η = 94%

Luminaire: Ledil Oy C13301STRADA-2X2-T3_(Duris_S8_Gen2)_SIMULATED
Lamps: 1 x OSRAM_DURIS S8 GEN2 5050 package

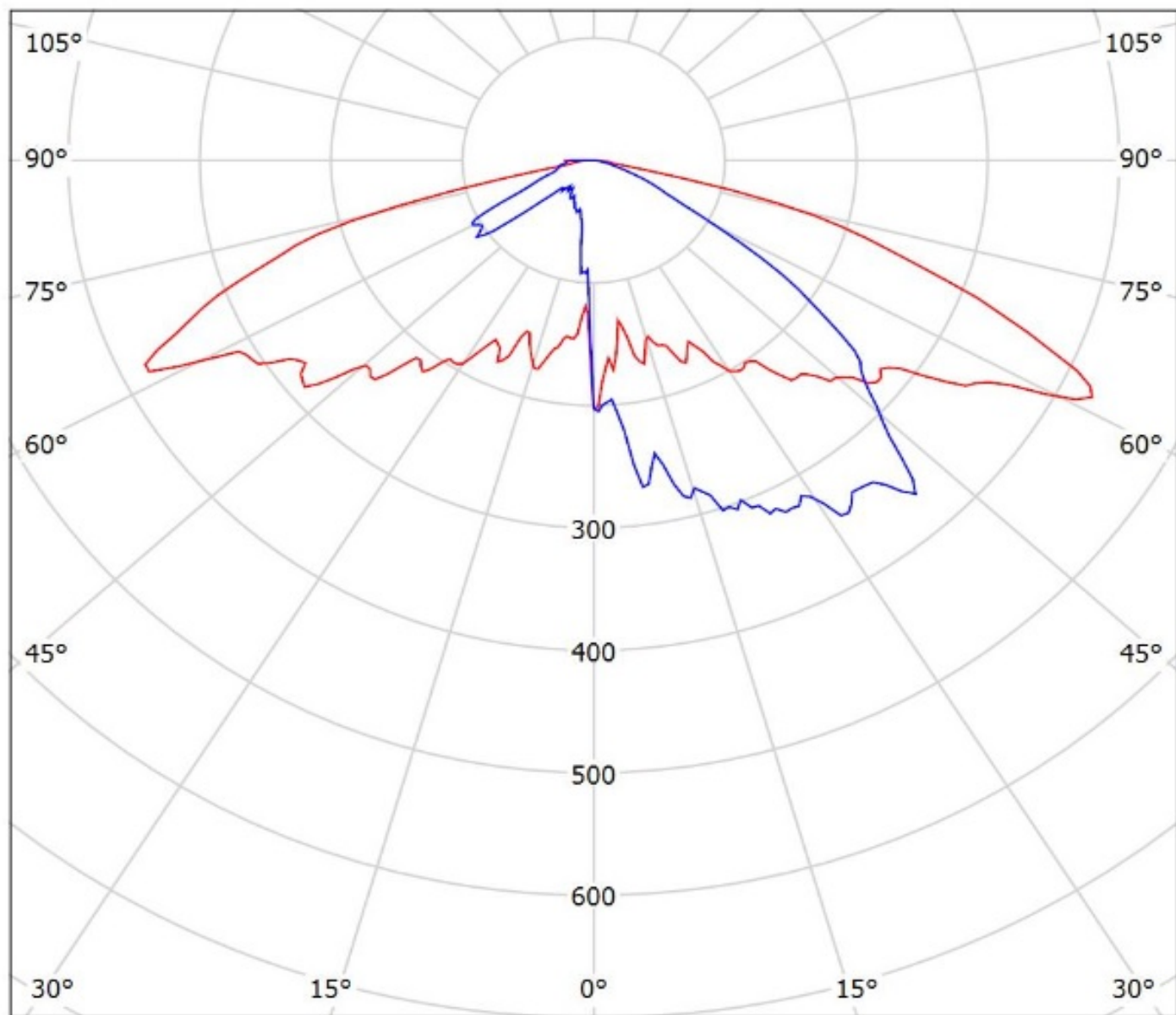

cd/klm
— C0 - C180 — C90 - C270

$\eta = 93\%$

Luminaire: Ledil Oy C13301_STRADA-2X2-T3_(Duris_P8)_SIMULATED
Lamps: 1 x Osram Duris P8

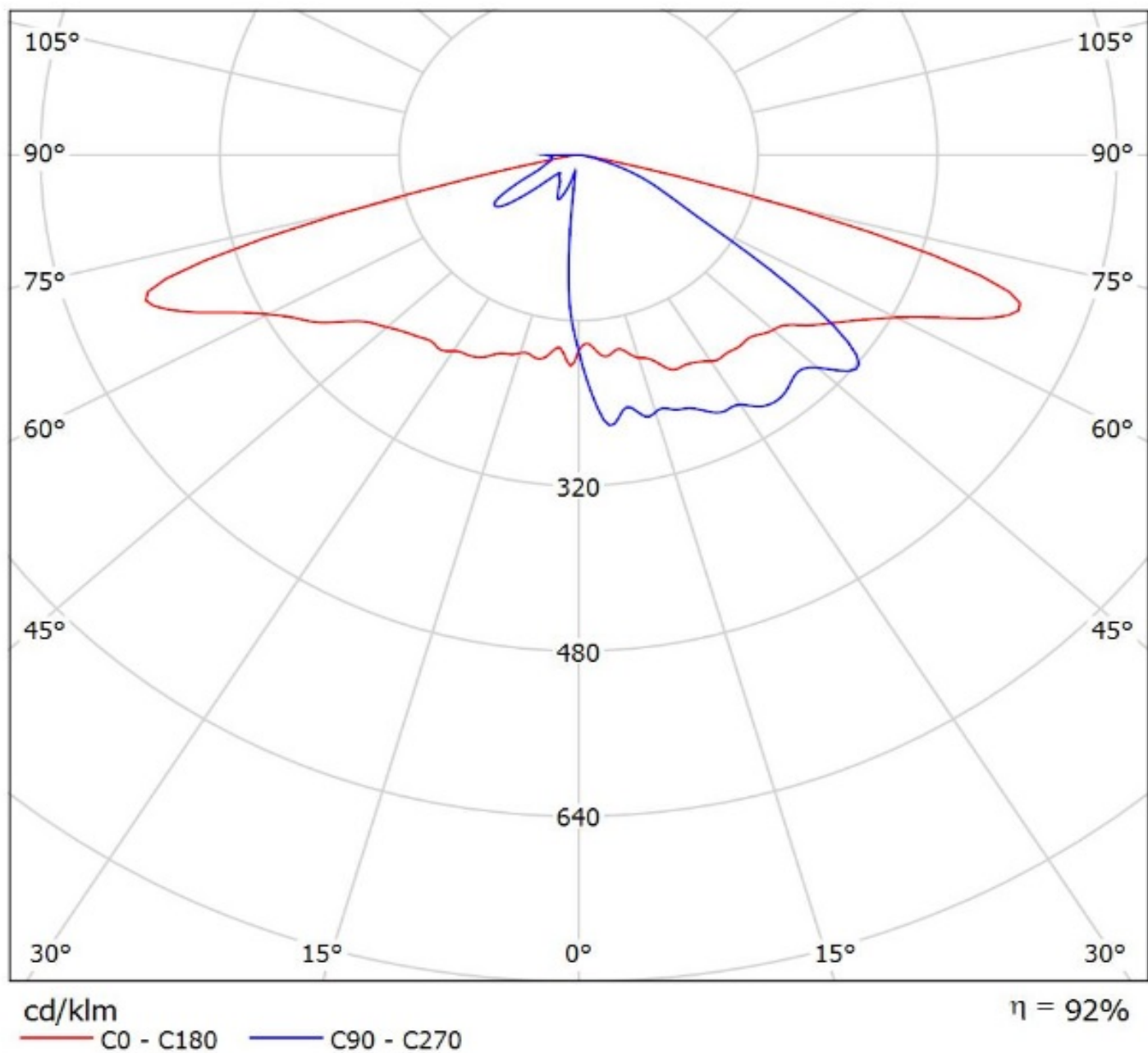

Luminaire: Ledil Oy C13301_STRADA-2X2-T3_OSRAM_DURIS_P9_SIMULATED
Lamps: 1 x OSRAM DURIS P9

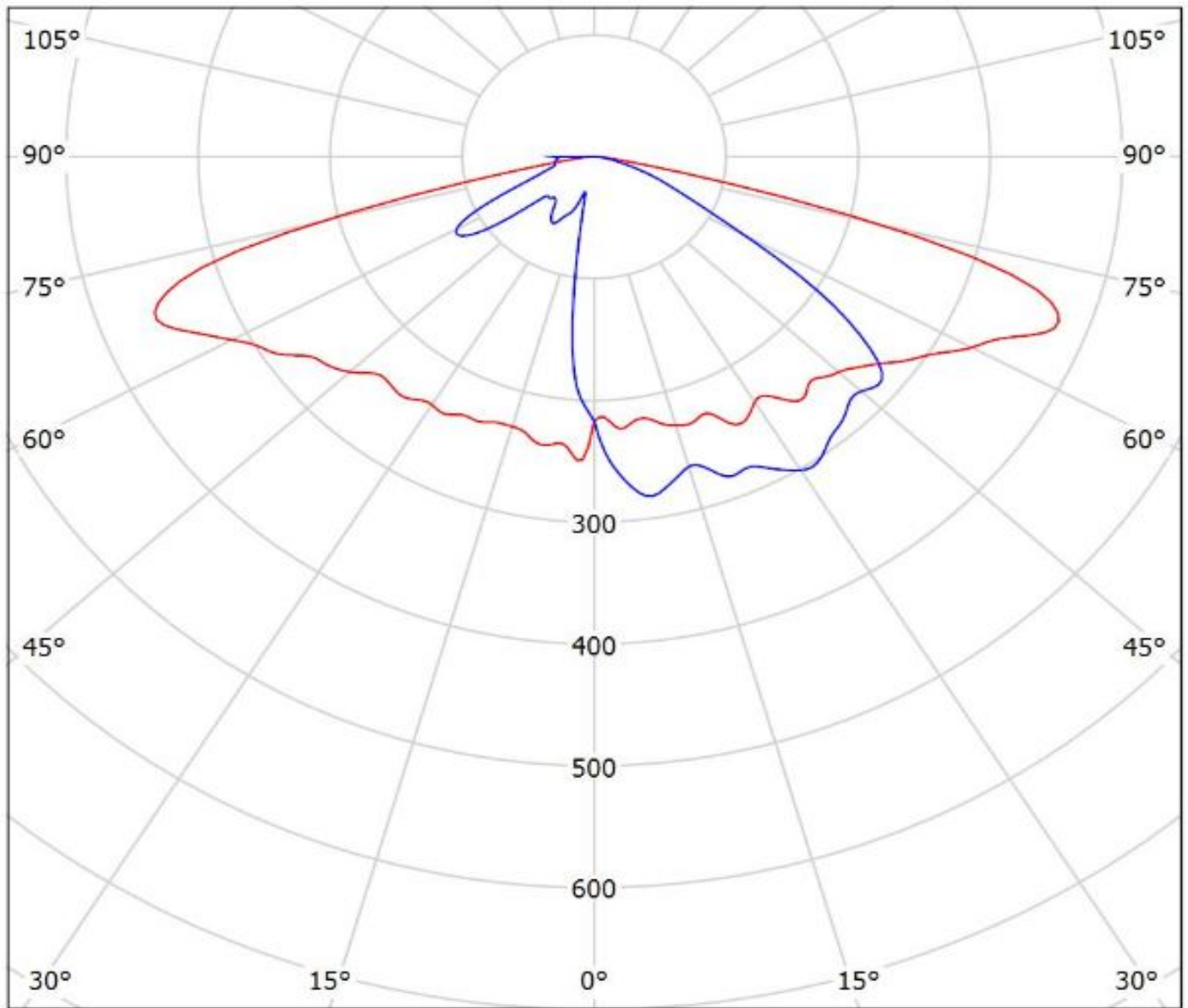

cd/klm
— C0 - C180 — C90 - C270

$\eta = 95\%$

LEDiL Oy C13301_STRADA-2X2-T3_(SSL80) Eff.95.0% / LDC (Polar)

Luminaire: LEDiL Oy C13301_STRADA-2X2-T3_(SSL80) Eff.95.0%

Lamps: 1 x Oslon_SSL80 (311lm@250mA)

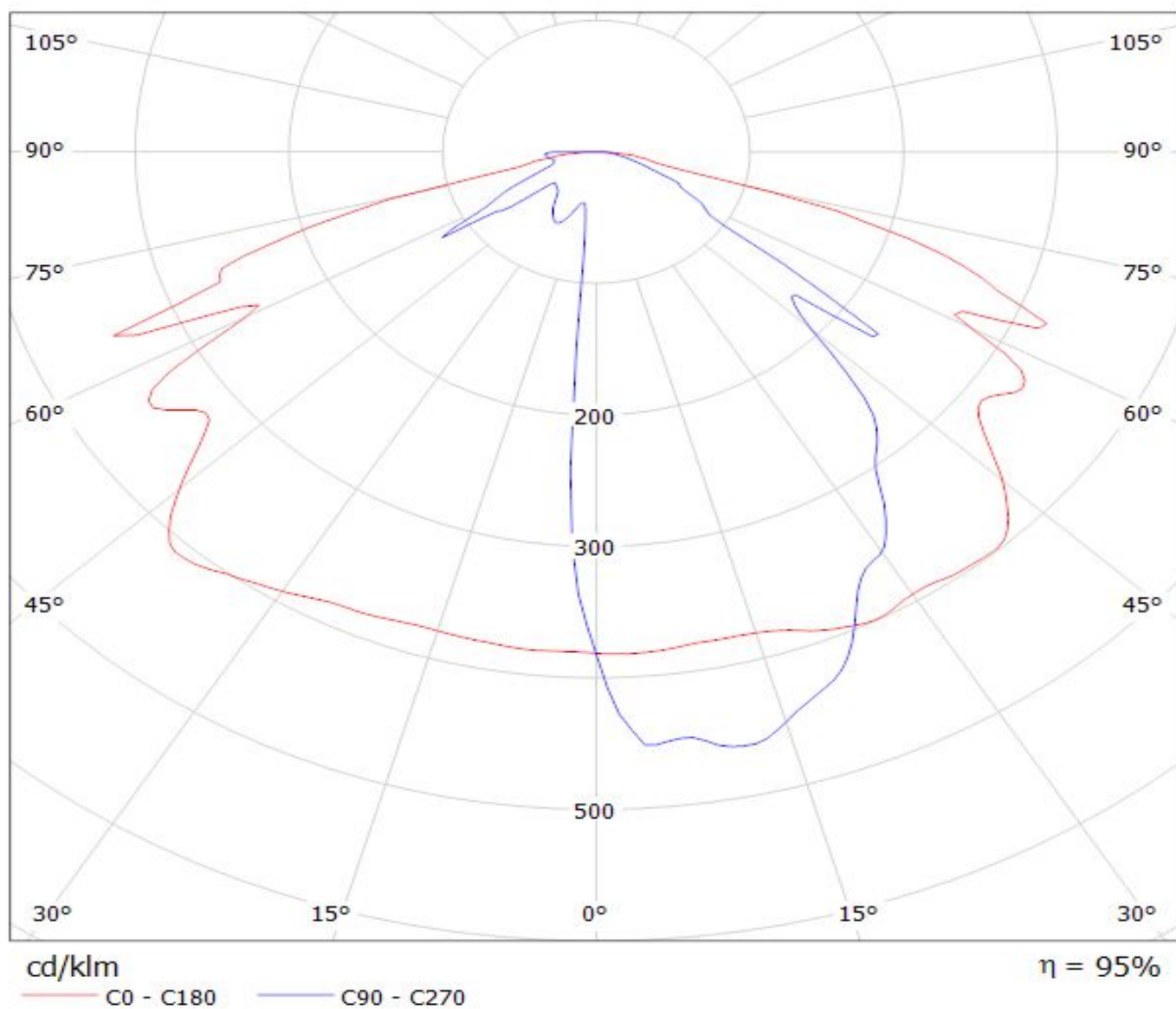

Luminaire: LEDiL Oy C13301_STRADA-2X2-T3_(Fortimo_F-Flex_2x8_740DAG3)
Lamps: 1 x Philips_Fortimo_F-Flex_2x8_740DAG3_1786.86lm@250mA_P=11.6092W_η=0.2498A

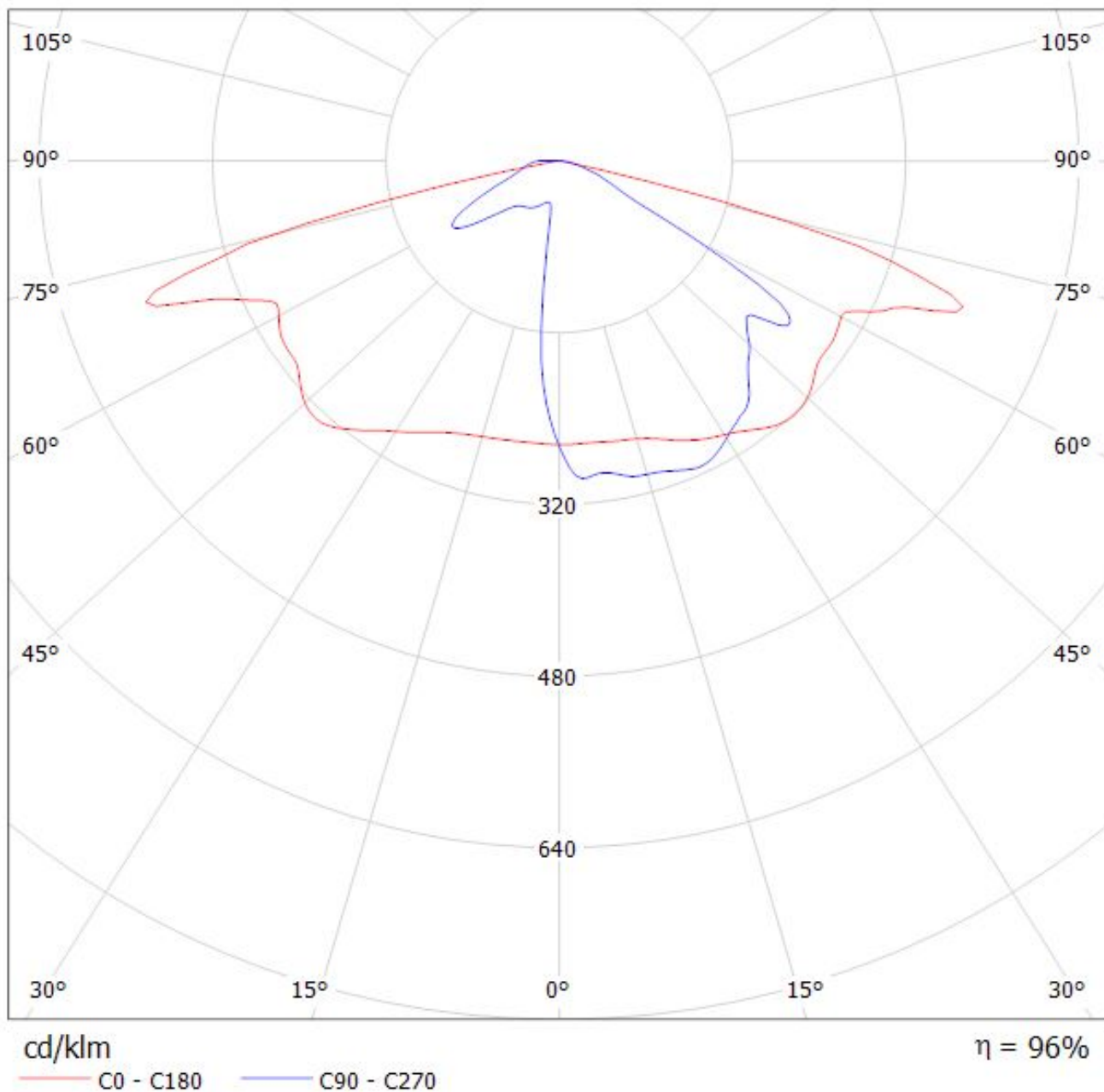

Luminaire: Ledil Oy Luminaire Catalog Number C13301_STRADA-2X2-T3_(Fortimo FastFlex LED board 2x8 DAX G4)_SIMULATED
Lamps: 1 x Fortimo FastFlex LED board 2x8 DAX G4

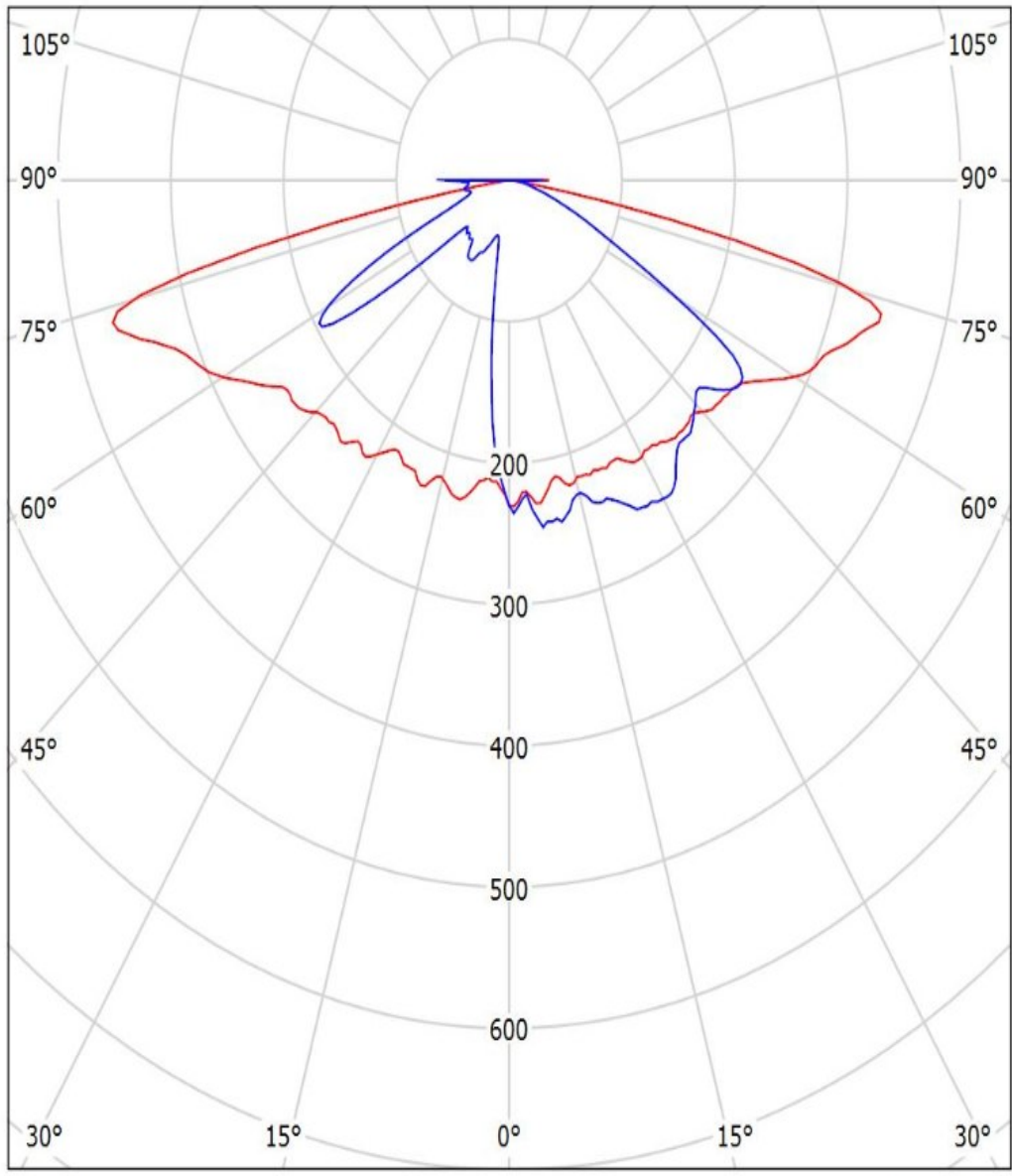

cd/klm

— C0 - C180 — C90 - C270

$\eta = 93\%$

LEDiL Oy C13301_STRADA-2X2-T3_(3535) Eff.94.0% / LDC (Polar)

Luminaire: LEDiL Oy C13301_STRADA-2X2-T3_(3535) Eff.94.0%
Lamps: 1 x Samsung_3535 (343lm@250mA)

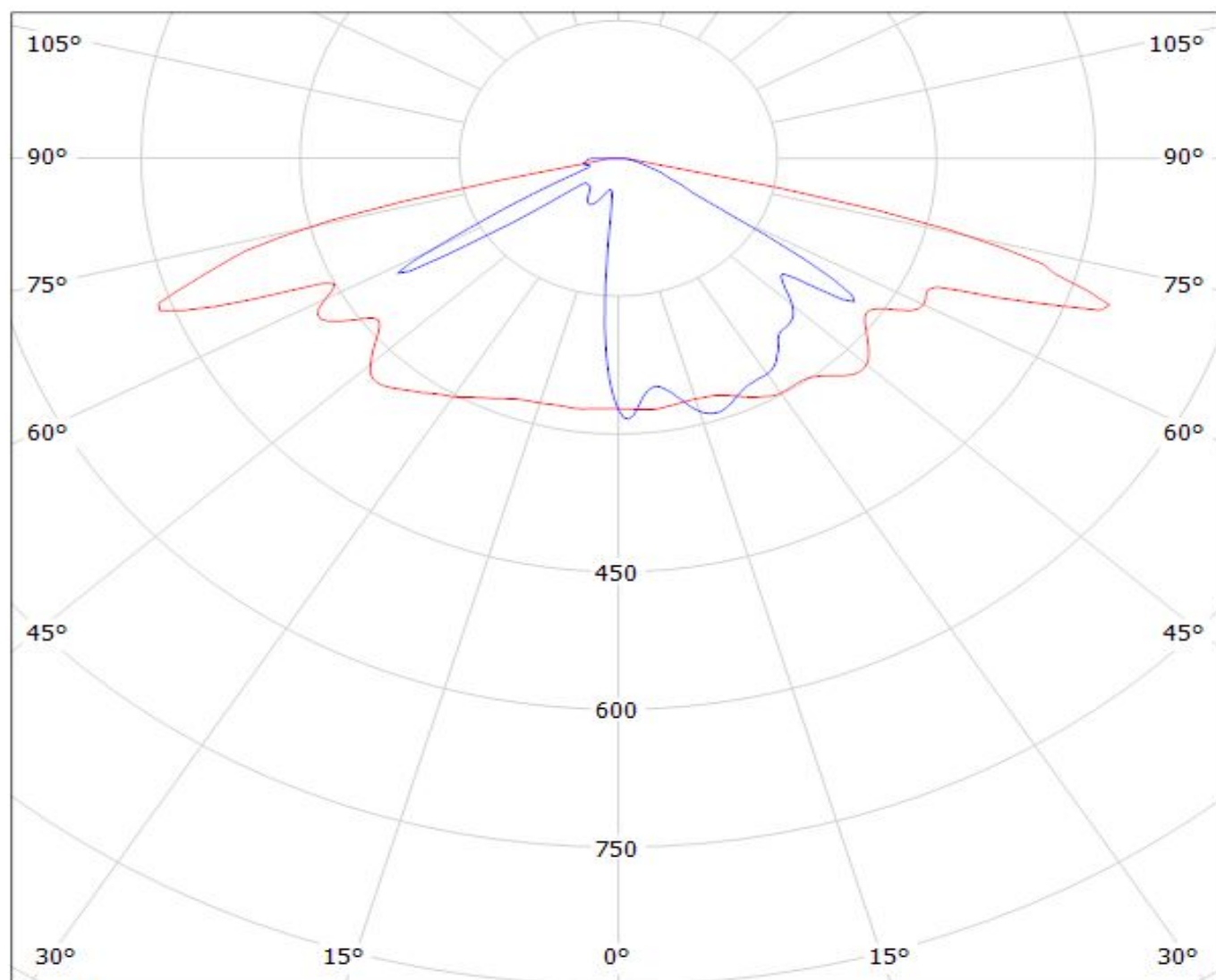

cd/klm

— C0 - C180

— C90 - C270

η = 94%

Luminaire: LEDiL Oy C13301_STRADA-2X2-T3_(LH351B)

Lamps: 1 x SAMSUNG_LH351B_2x2_442.67lm@250mA_P=2.84311W_I=249.9mA

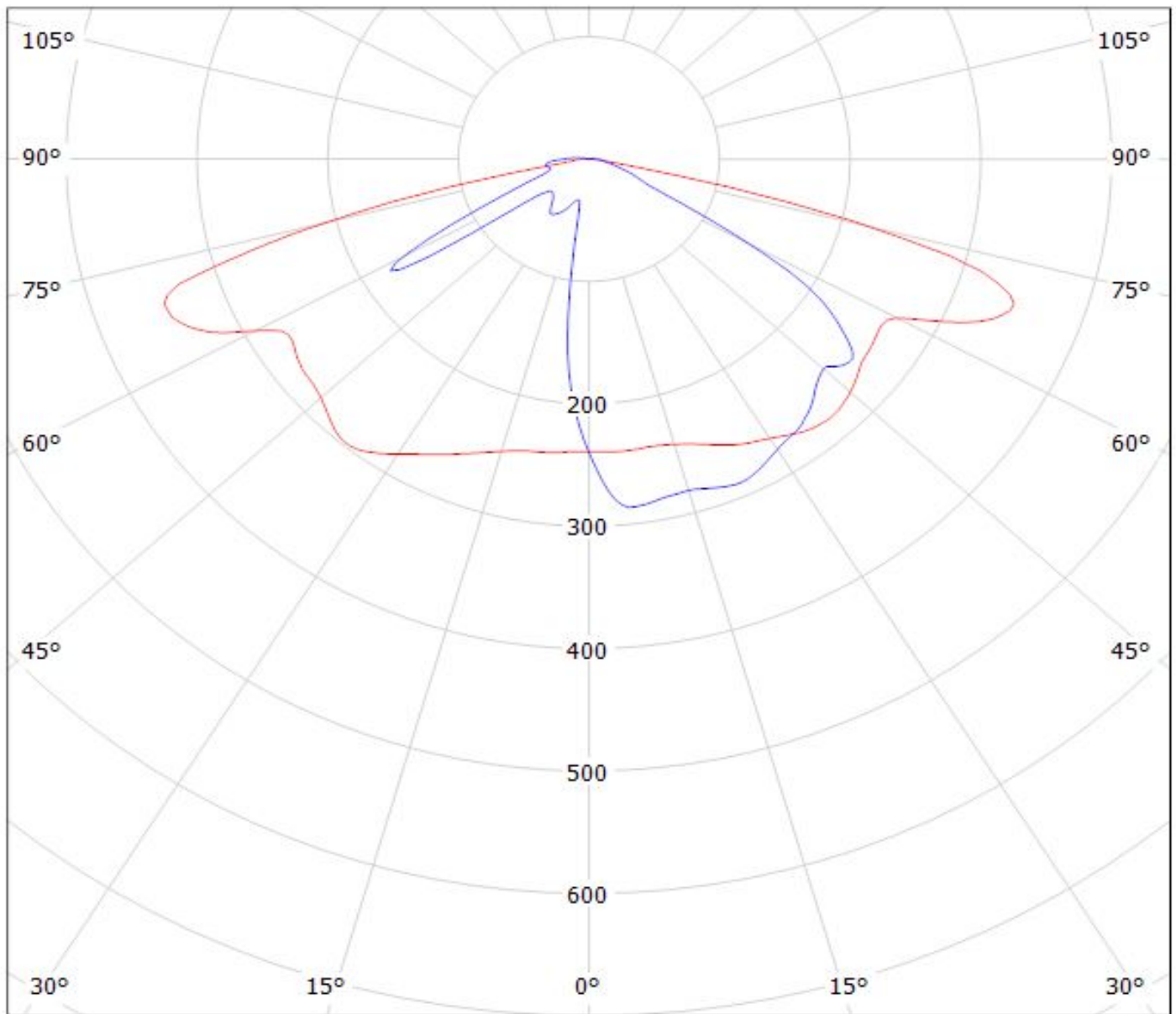

cd/klm

— C0 - C180

— C90 - C270

$\eta = 94\%$

Luminaire: LEDiL Oy C13301_STRADA-2X2-T3_(LH351Z)

Lamps: 1 x SAMSUNG_LH351Z_2x2_367.19lm@250mA_P=2.86596W_I=249.8mA

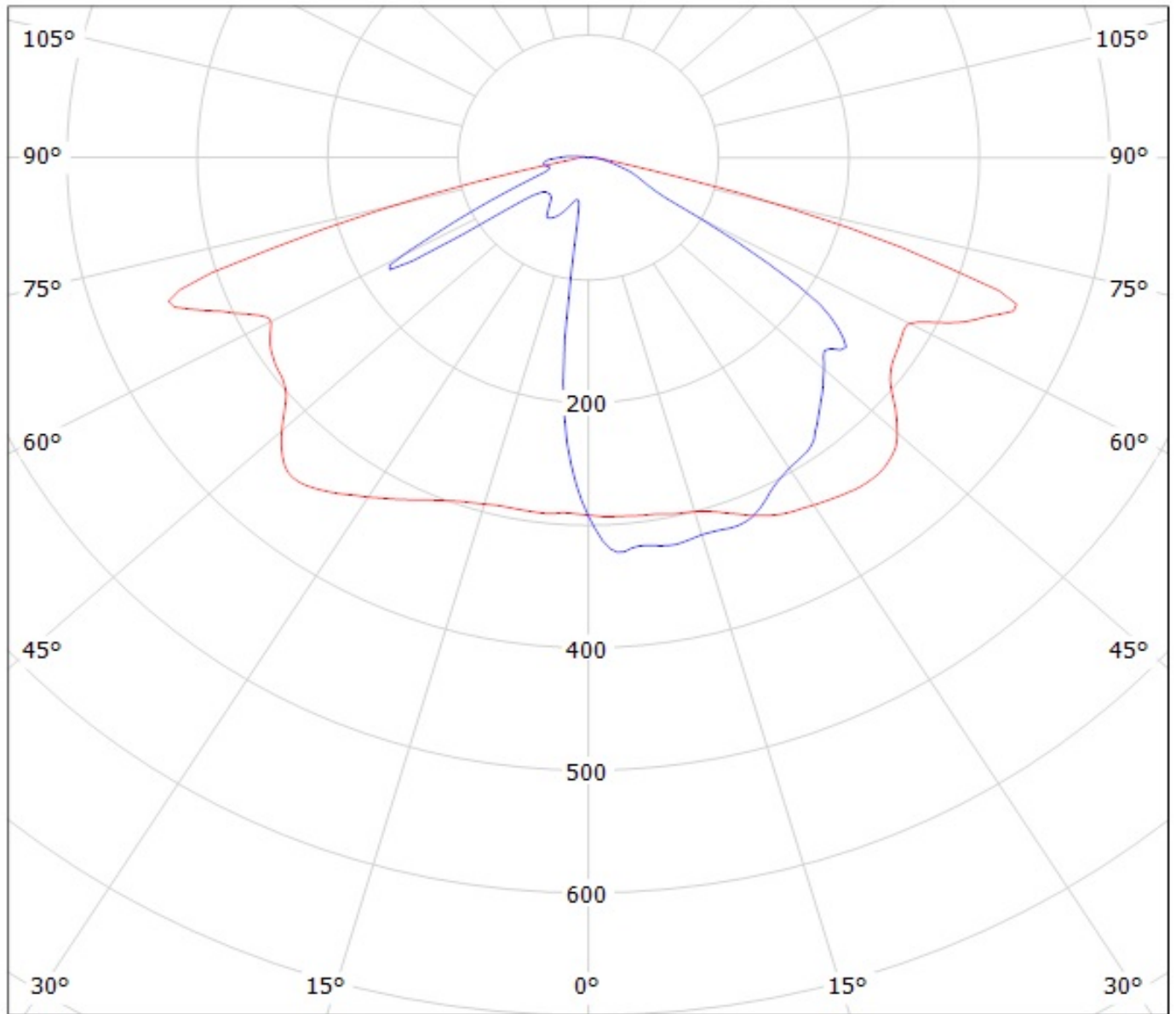

cd/klm

— C0 - C180

— C90 - C270

$\eta = 94\%$

Luminaire: LEDiL Oy C13301_STRADA-2X2-T3_(LH351D)
Lamps: 1 x Samsung_LH351D_524.264lm@250mA_P=2.7523W_I=0.250A

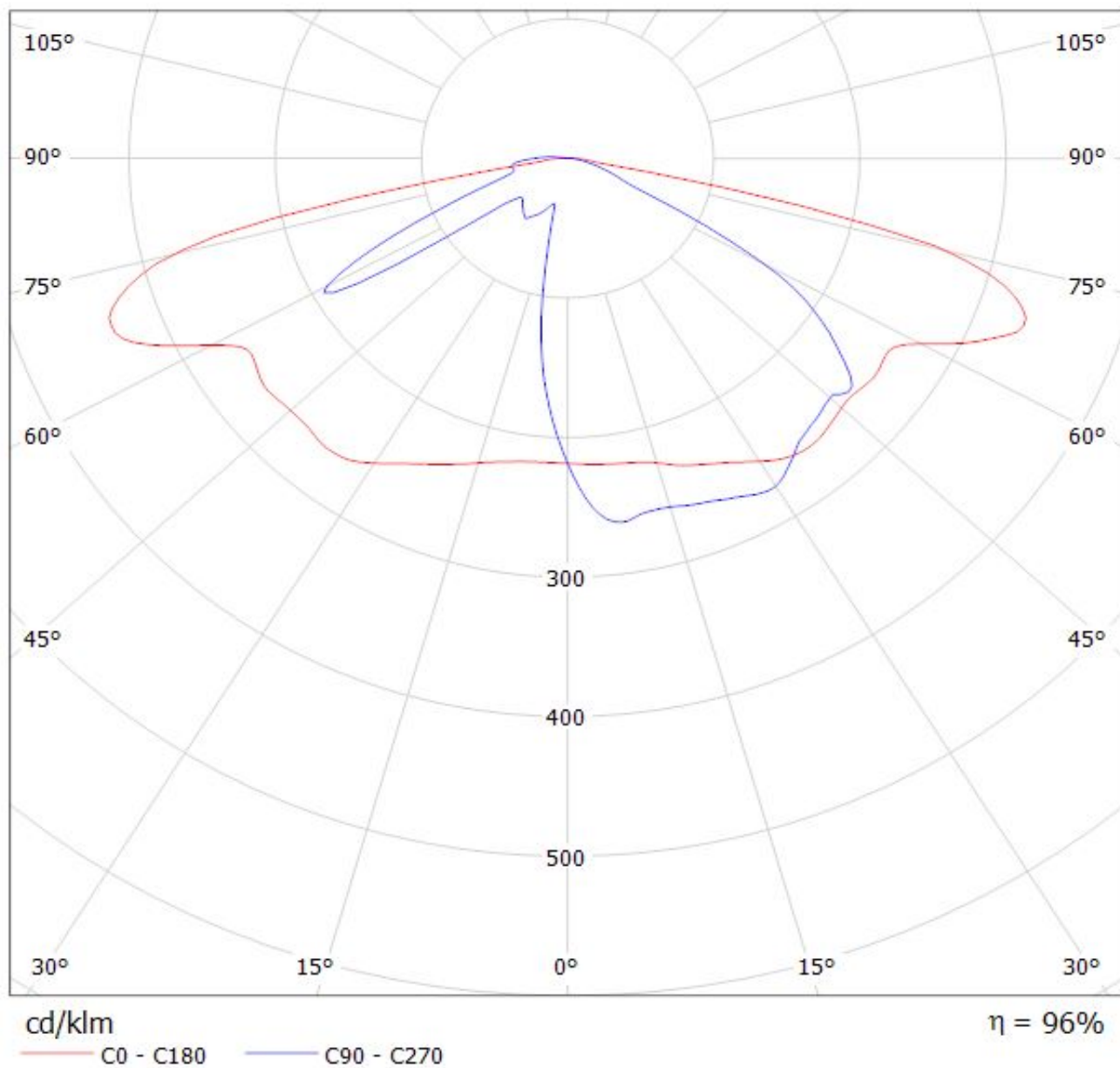

Luminaire: Ledil C13301_STRADA-2X2-T3_(LH351C)
Lamps: 1 x Samsung_LH351C_518.223lm@250mA_P=2.85225W_I=0.25A

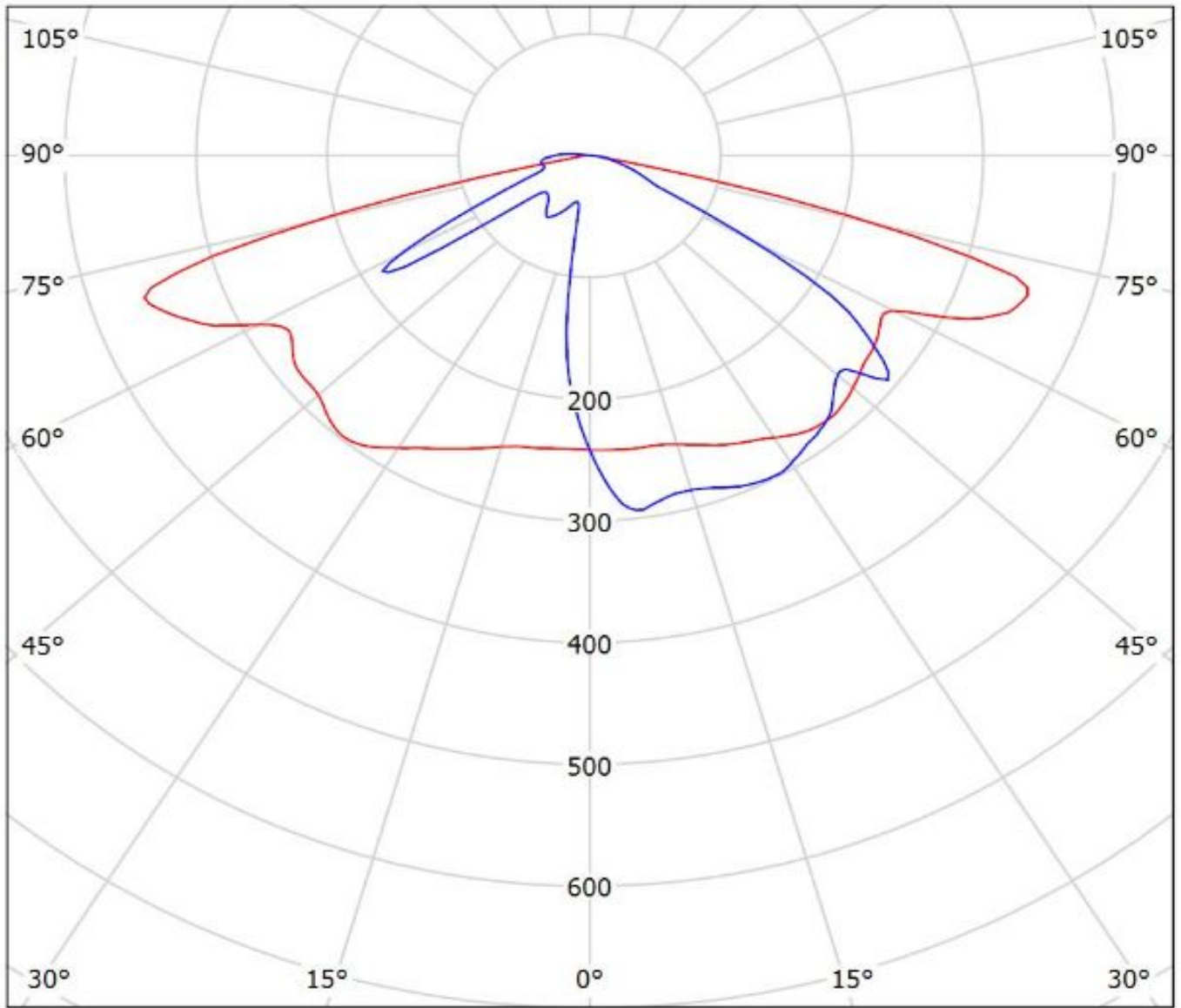

cd/klm
— C0 - C180 — C90 - C270

$\eta = 98\%$

Luminaire: Ledil C13301_STRADA-2X2-T3_(LH508A)

Lamps: 1 x Samsung_LH508A_2x2_2060.04lm@160mA_CCT=5000K_CRI=80_P=15.5405W_I=0.16A

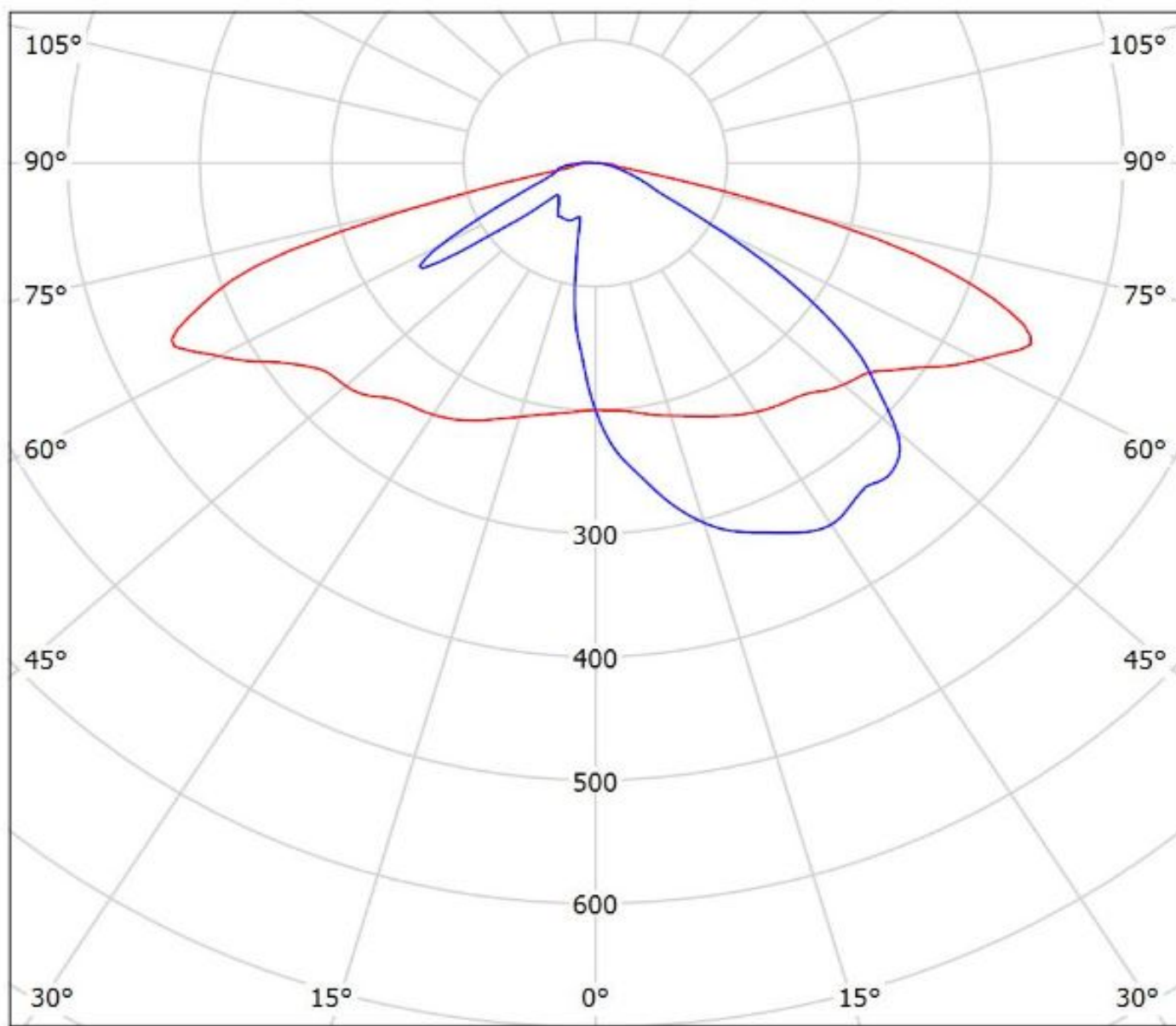

cd/klm

— C0 - C180 — C90 - C270

$\eta = 98\%$

LEDiL Oy C13301_STRADA-2X2-T3_(Z5P) Eff.94.3% / LDC (Polar)

Luminaire: LEDiL Oy C13301_STRADA-2X2-T3_(Z5P) Eff.94.3%

Lamps: 1 x Seoul Z5P (290lm@250mA)

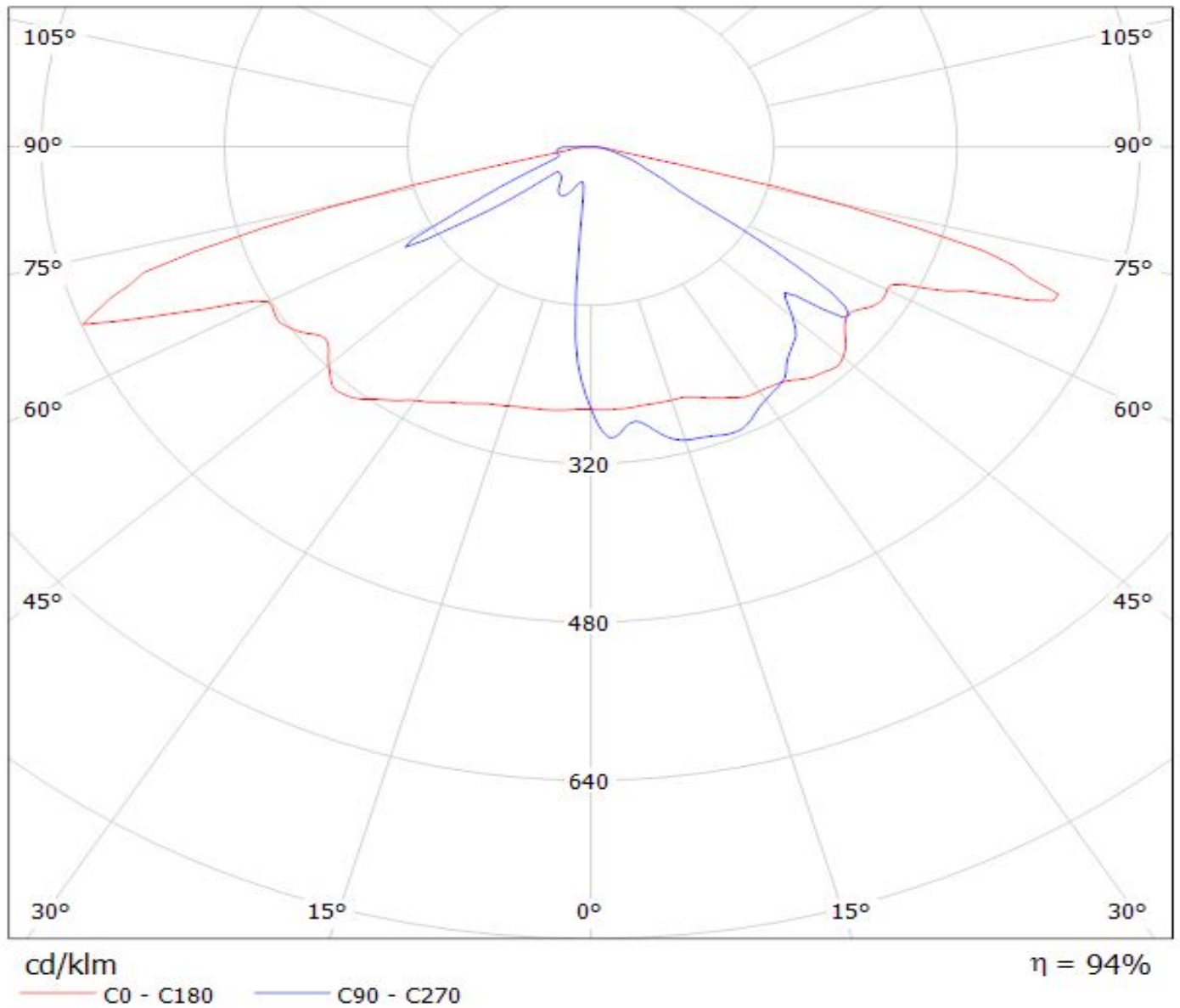

LEDiL Oy C13301_STRADA-2x2-T3_(MJT4040) Eff.94.0% / LDC (Polar)

Luminaire: LEDiL Oy C13301_STRADA-2x2-T3_(MJT4040) Eff.94.0%

Lamps: 1 x SEOUL ACHRICH MJT4040 (SAW09H0A) 258lm@40mA P=2.37W I=40mA

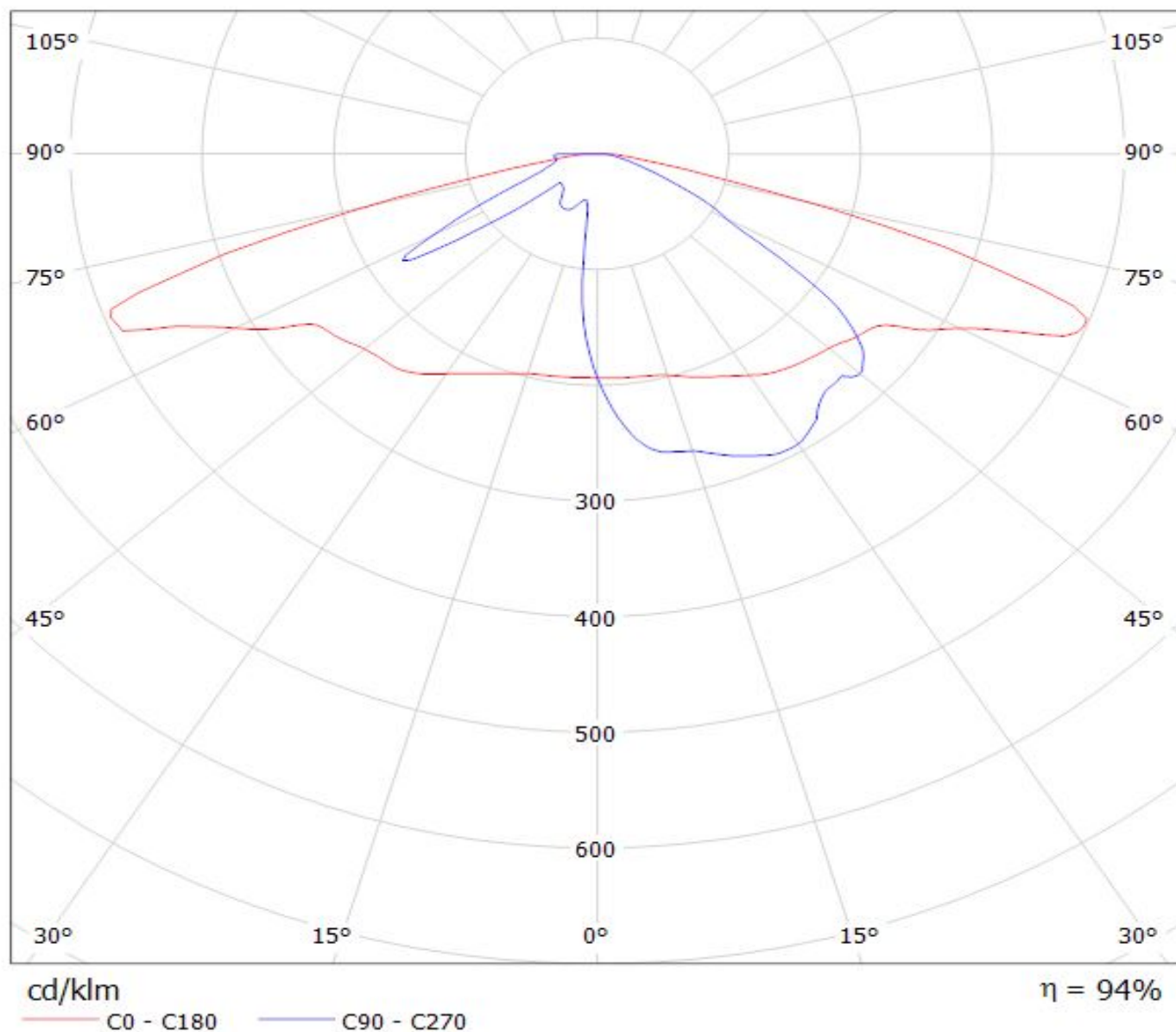

LEDiL Oy C13301_STRADA-2X2-T3_(Z5M) Eff.94.0% / LDC (Polar)

Luminaire: LEDiL Oy C13301_STRADA-2X2-T3_(Z5M) Eff.94.0%

Lamps: 1 x SEOUL_Z5M_(SZ5-M0-W0-00)_362.8lm@250mA_P=2.95788W_I=249.8mA

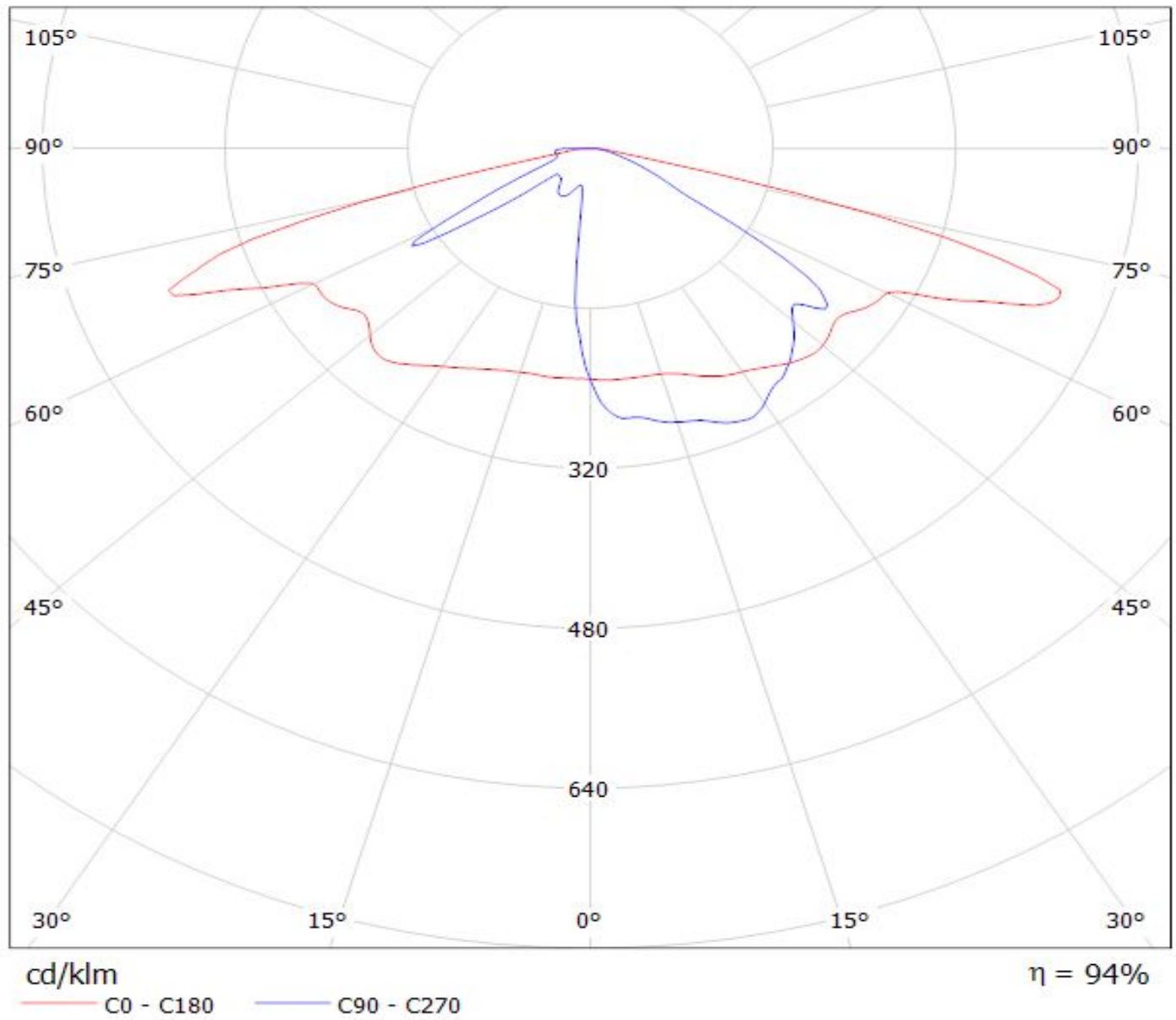

Luminaire: LEDil Oy C13301_STRADA-2X2-T3_(Z5M1) Efficiency=94%

Lamps: 1 x Seoul Z5M1 (SZ5-M1-WN-C8) 379lm @ 250mA CCT=4600K P=2.9W I=250mA

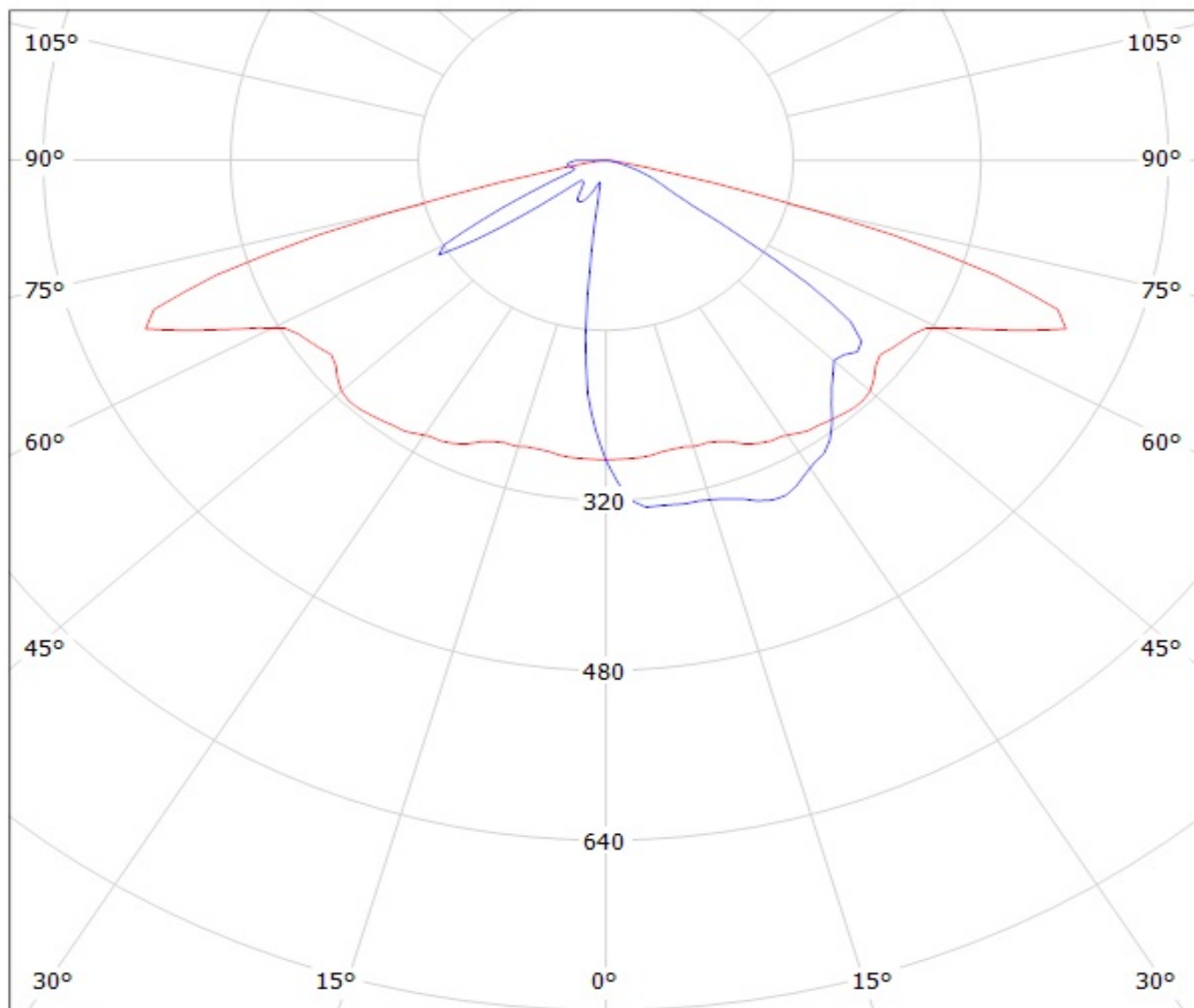

cd/klm

— C0 - C180

— C90 - C270

Luminaire: Ledil C13301_STRADA-2X2-T3_(Z8Y22plus)

Lamps: 1 x Seoul_Z8Y22plus_(W6E2G)_513.996lm@250mA_P=2.754W_I=0.250A

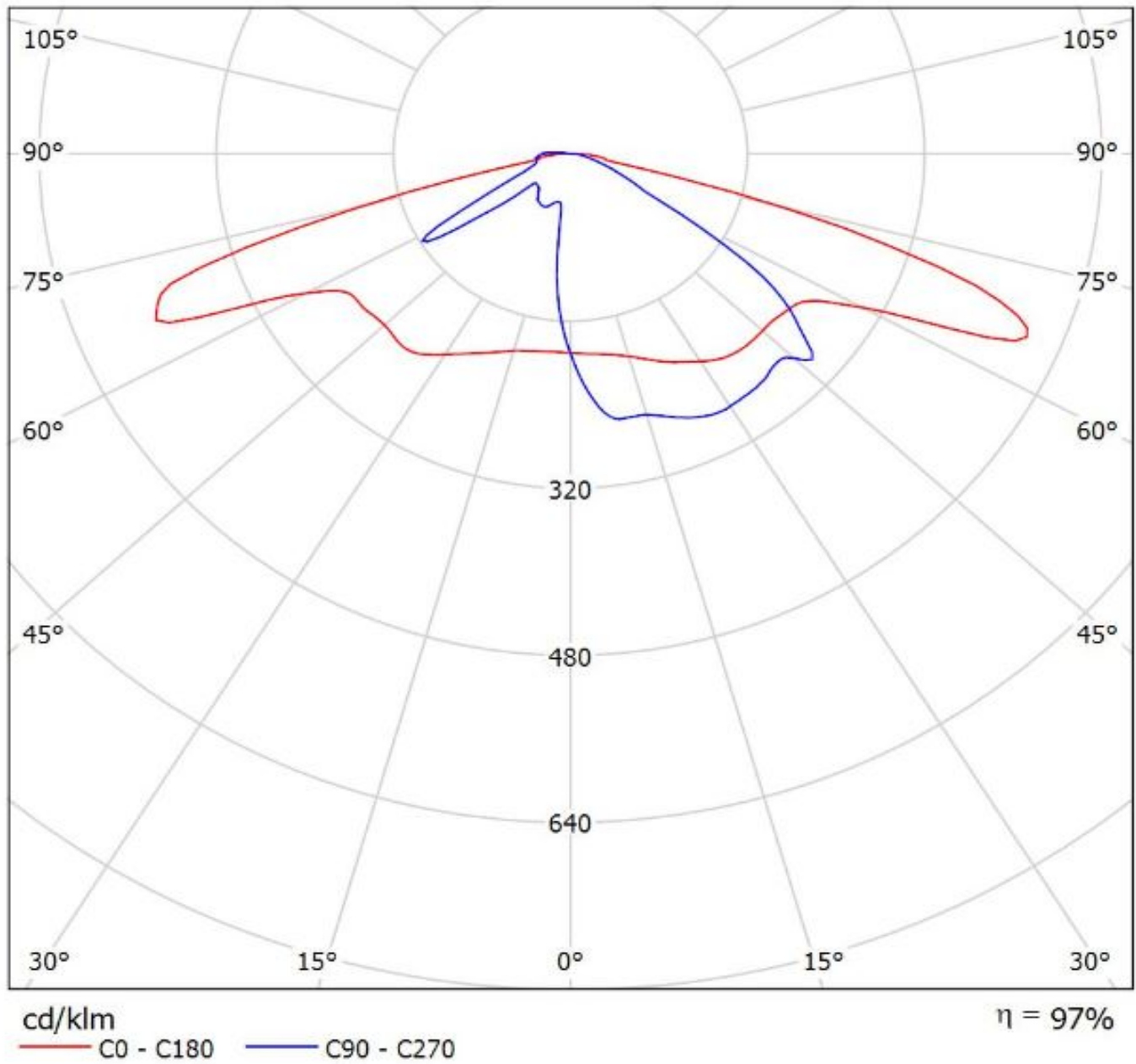

Luminaire: Ledil Oy C13301_STRADA-2X2-T3_(Z8Y22)_SIMULATED

Lamps: 1 x Seoul SZ8Y22

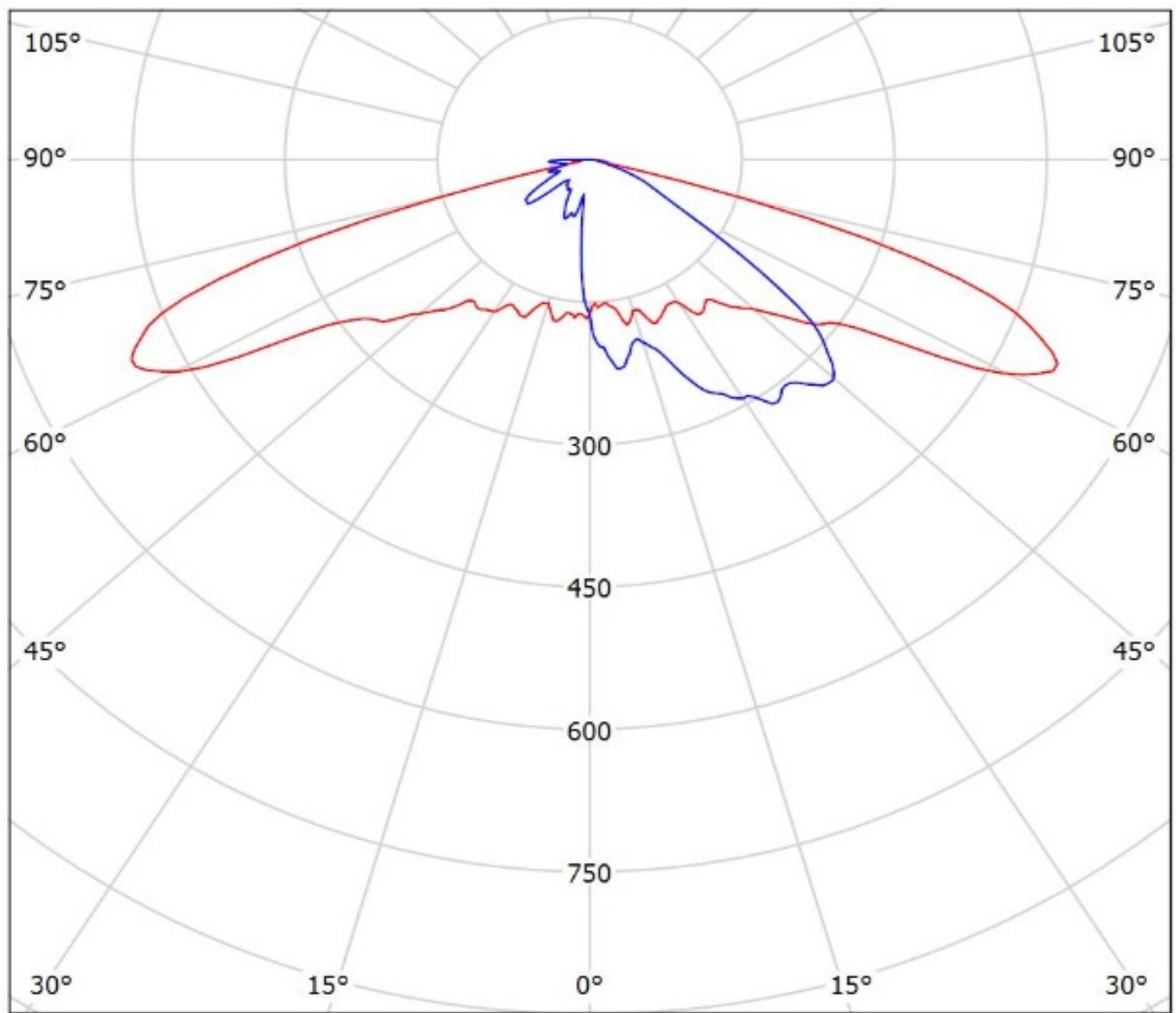

cd/klm

— C0 - C180 — C90 - C270

η = 94%

Luminaire: LEDiL Oy C13301_STRADA-2X2-T3_(Z8Y22)

Lamps: 1 x Seoul_Wicop_Z8Y22_497.373lm@250mA_P=2.80076W_U=11.211V

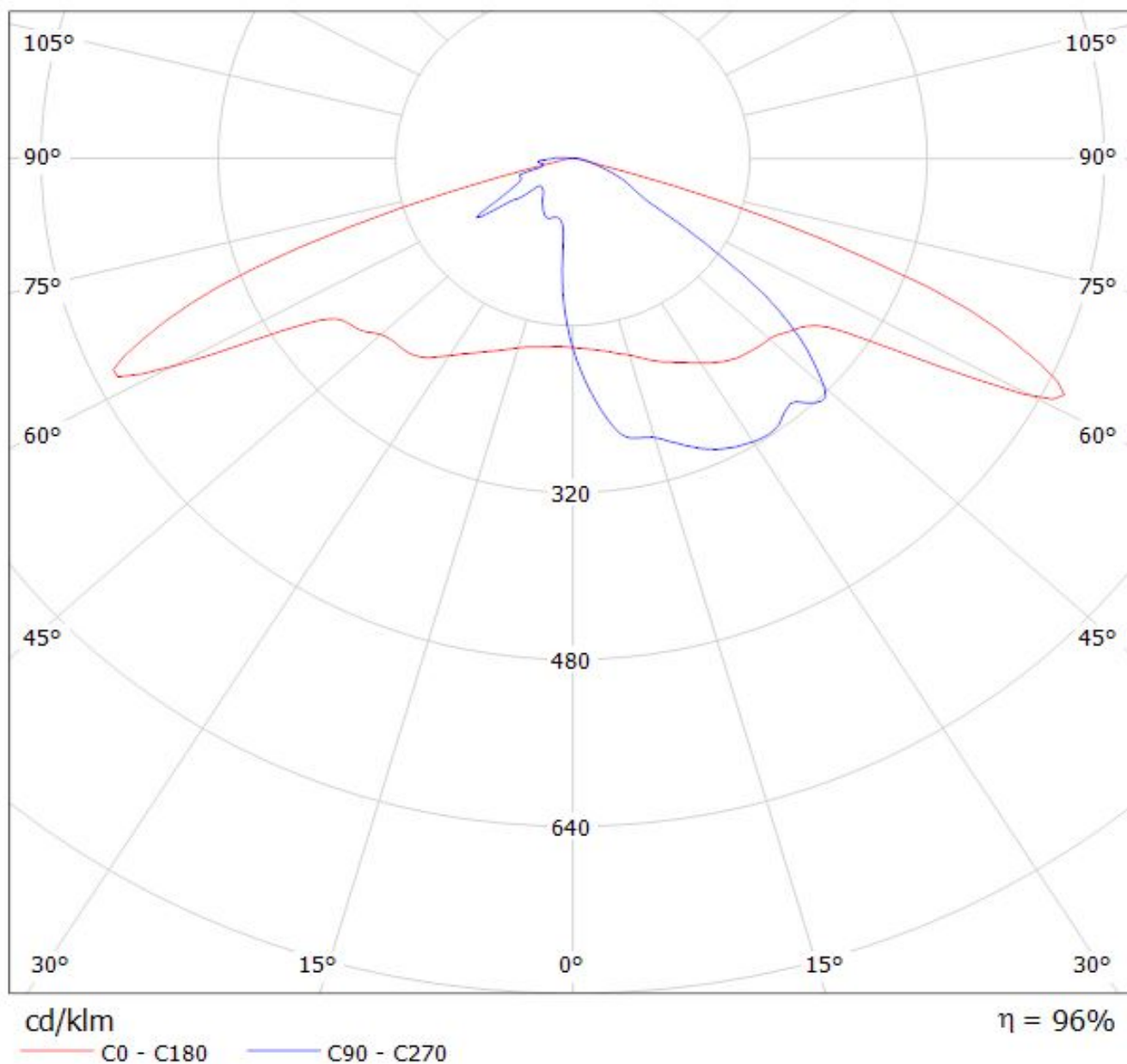

Ledil C13301_STRADA-2X2-T3_(TL1L3) / LDC (Polar)

Luminaire: Ledil C13301_STRADA-2X2-T3_(TL1L3)

Lamps: 1 x Toshiba_TL1L3_2x2_(TL1L3-NW1.L)_387.773lm@250mA_CCT=5000K_P=2.829W_I=0.25A

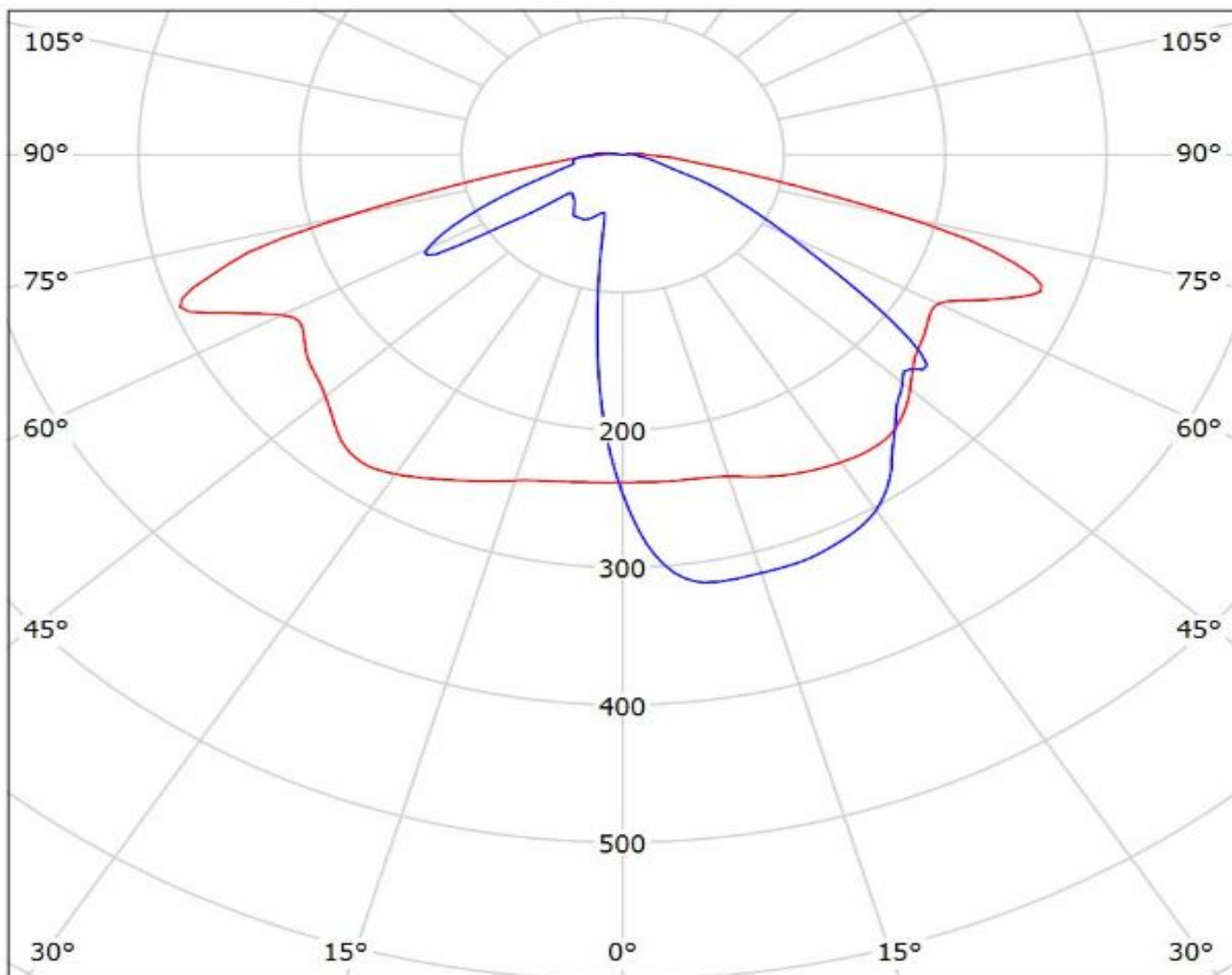

Ledil C13301_STRADA-2X2-T3_(TL1L4) / LDC (Polar)

Luminaire: Ledil C13301_STRADA-2X2-T3_(TL1L4)

Lamps: 1 x Toshiba_TL1L4_2x2_(TL1L4-DW0)_472.639lm@250mA_CCT=6500K_P=2.9W_I=0.25A

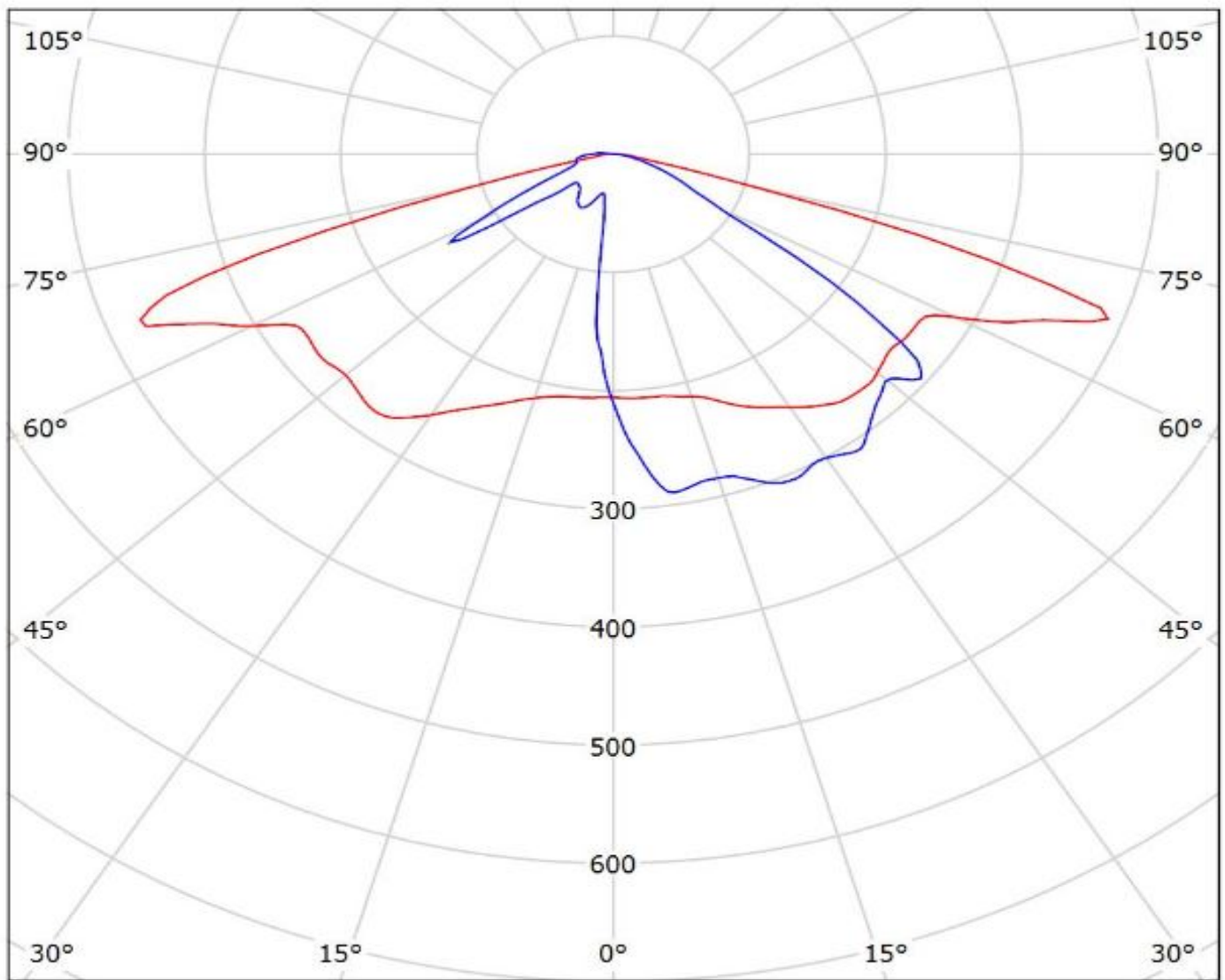

cd/klm

— C0 - C180 — C90 - C270

$\eta = 91\%$

Luminaire: LEDiL Oy C13301_STRADA-2X2-T3_(Tridonic_Module_RLE_G1)
Lamps: 1 x Tridonic_Module_RLE_G1_4576.03lm@700mA_P=32.0681W_I=0.700A

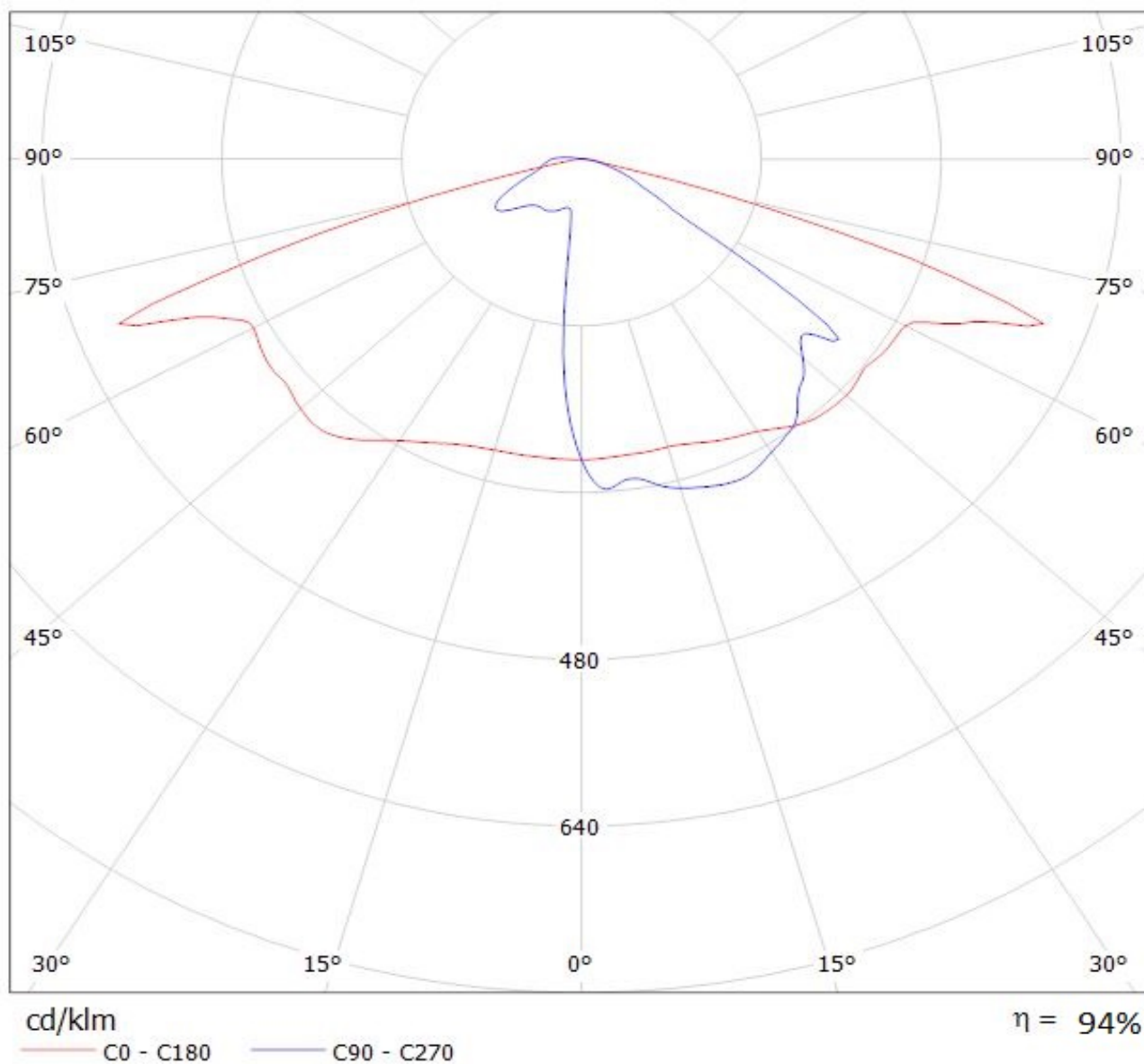

Luminaire: LEDiL Oy C13301_STRADA-2X2-T3_(Tridonic_Module_RLE_G1)
Lamps: 1 x Tridonic_Module_RLE_G1_4576.03lm@700mA_P=32.0681W_I=0.700A

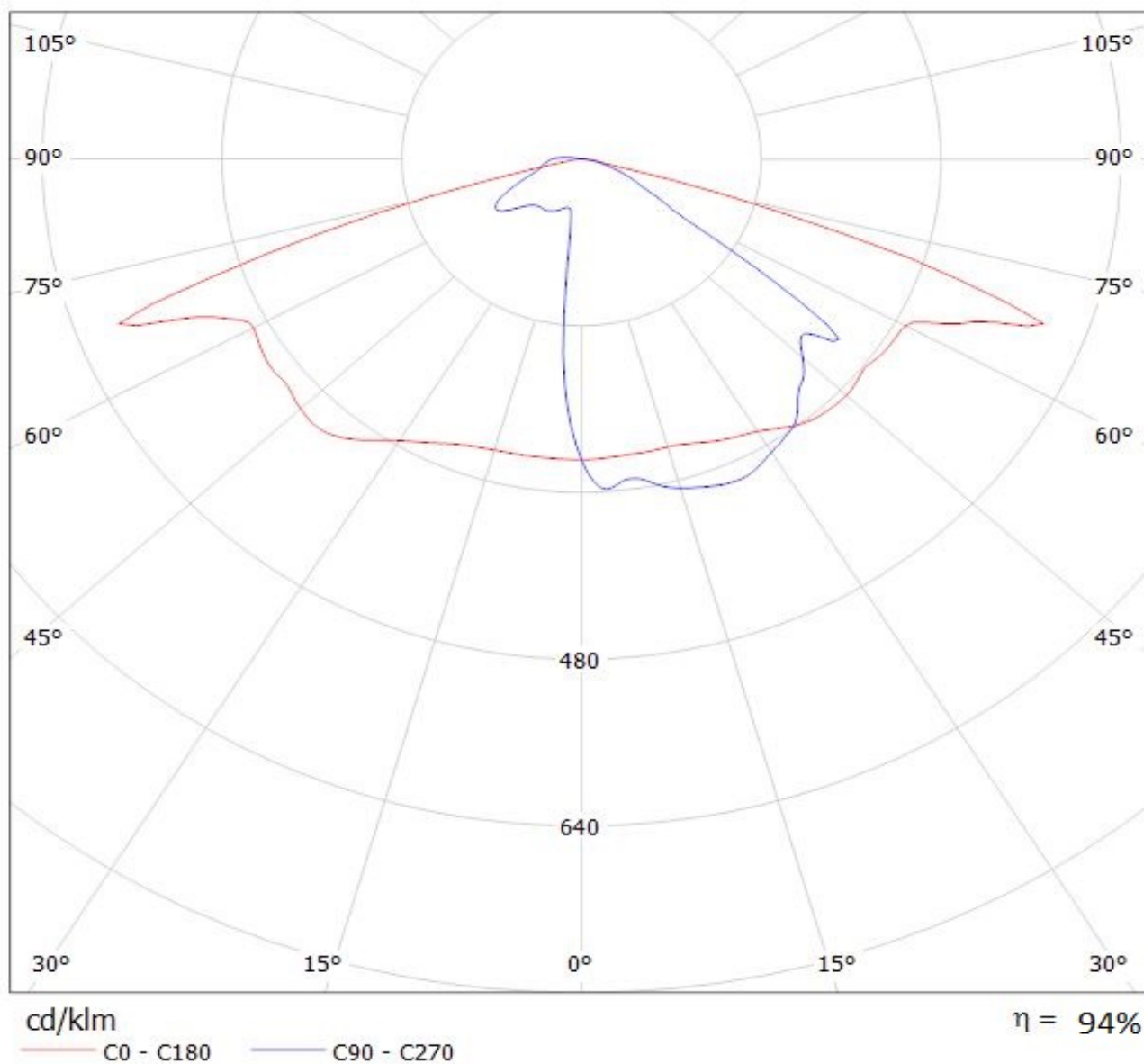

Luminaire: LEDiL Oy C13301_STRADA-2X2-T3_(Tridonic_Module_RLE_G1)
Lamps: 1 x Tridonic_Module_RLE_G1_2288lm@700mA_P=16W_I=0.700A

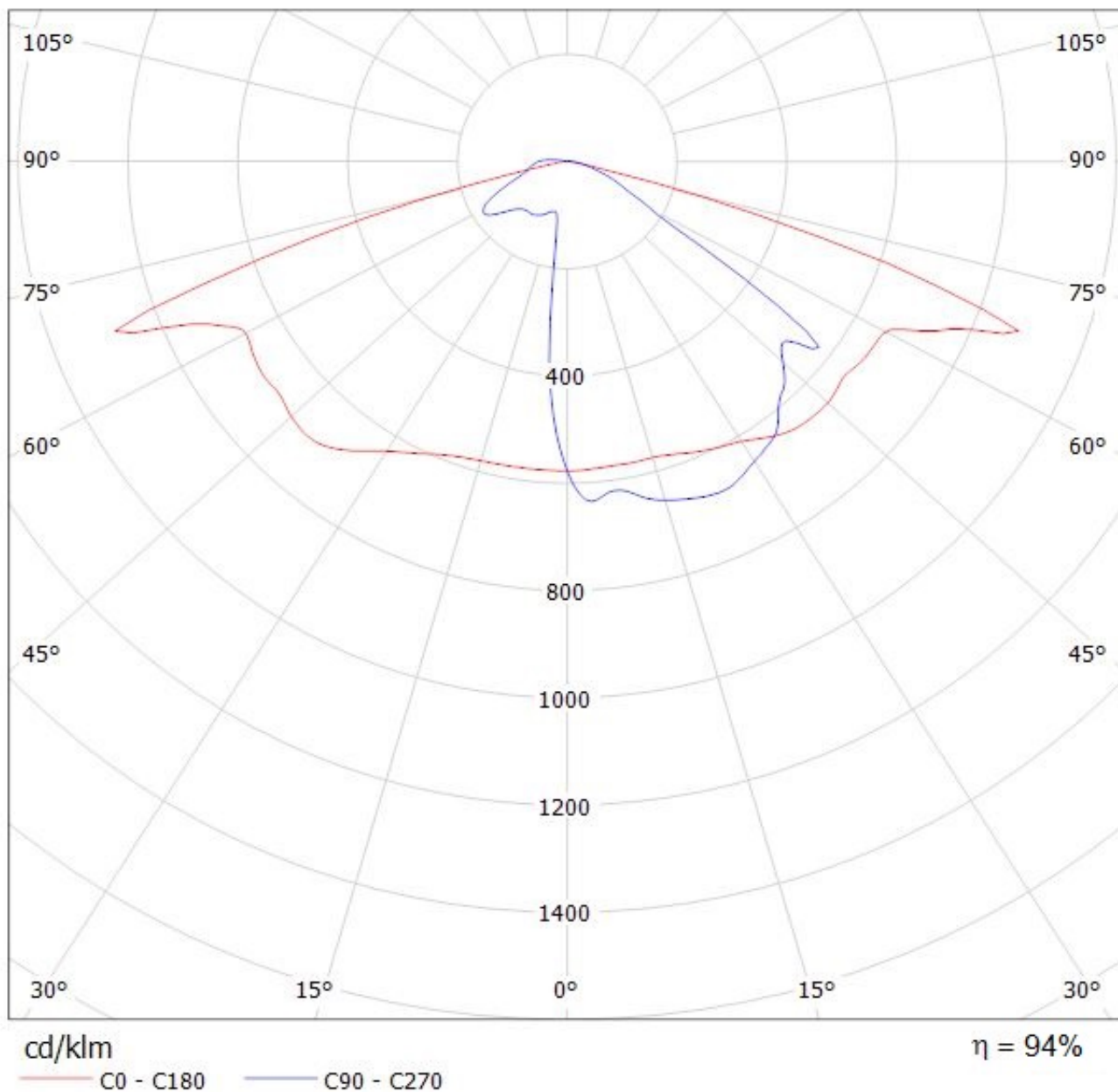

Luminaire: LEDiL Oy C13301_STRADA-2X2-T3_(Tridonic_Module_RLE_G1)
Lamps: 1 x Tridonic_Module_RLE_G1_2288lm@700mA_P=16W_I=0.700A

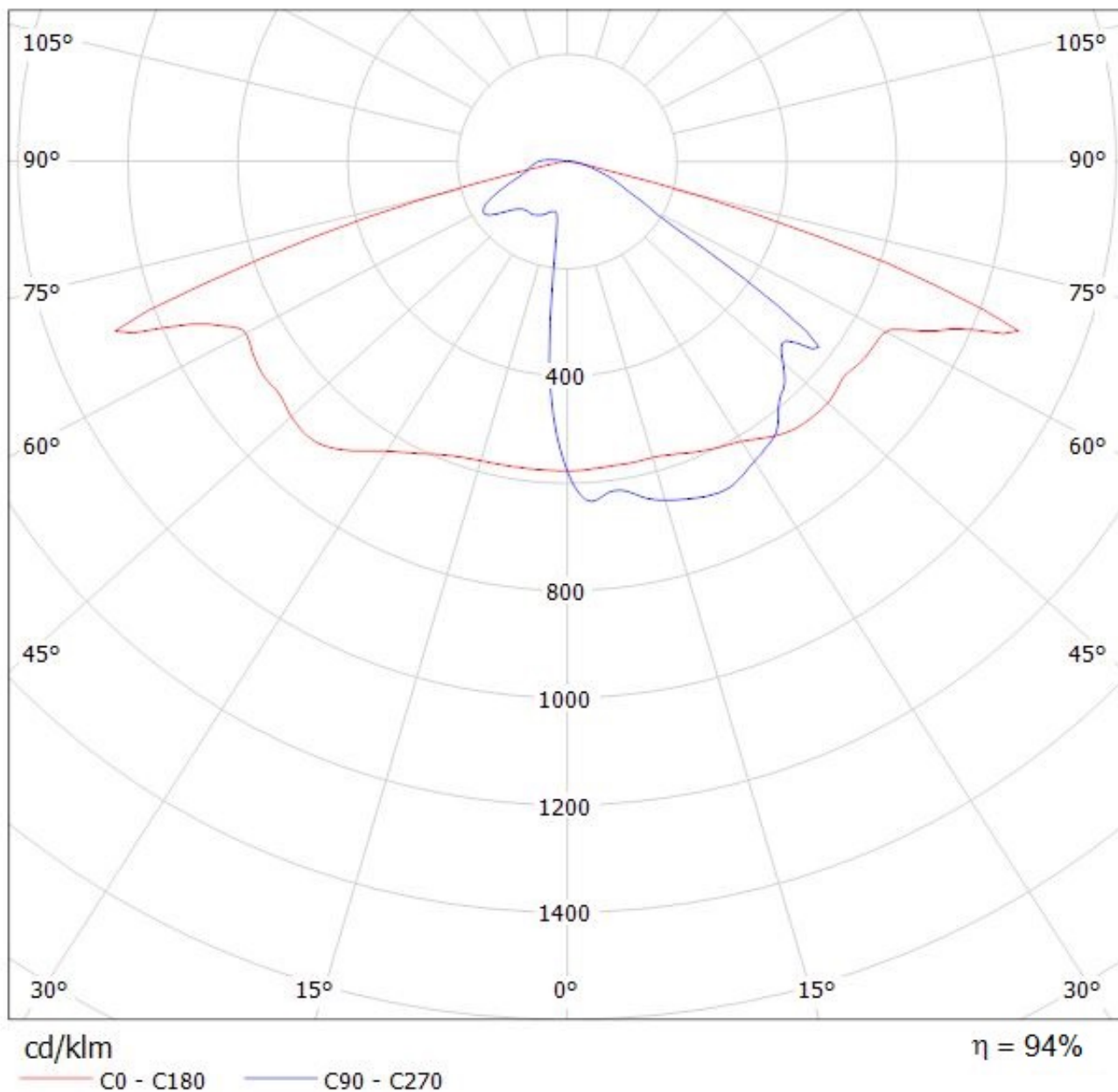

NOTE: The typical divergence will be changed by different color, chip size and chip position tolerance. The typical total divergence is the full angle measured where the luminous intensity is half of the peak value.