

DETAILS

Product Number	C15021_STRADA-2X2-SCL
Family	Strada
Type	Lens
Color	clear
Diameter	50 mm
Height	7,8 mm
Style	square
Optic Material	PMMA
Holder Material	
Fastening	screw, pin
Status	production ready
ROHS Compliant	Yes
Date Updated	21/04/2016

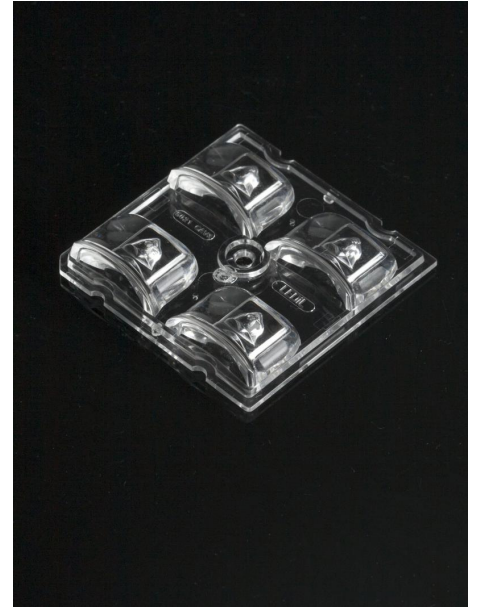

OPTICAL PROPERTIES

LED	Viewing Angle	Light Beam	Efficiency	cd/lm	Connector
SMD 5050	Asymmetric deg	Streetligh...	94 %	0.630	-
QUICK FLUX XTP 2x4 xxx LS G5	Asymmetric deg	Streetligh...	94 %	1.000	-
QUICK FLUX XTP 2x6 xxx LS G5	Asymmetric deg	Streetligh...	94 %	1.000	-
QUICK FLUX XTP 2x8 xxx LS G5	Asymmetric deg	Streetligh...	94 %	1.000	-
XB-H	sim: Asymmetri	Streetligh...	-	-	-
XHP35 HD	sim: Asymmetri	Streetligh...	-	-	-
XM-L2	sim: Asymmetri	Streetligh...	-	-	-
XP-L	Asymmetric deg	Streetligh...	94 %	0.900	-
XP-L HI	sim: Asymmetri	Streetligh...	-	-	-
XT-E	sim: Asymmetri	Streetligh...	-	-	-
XP-L	Asymmetric deg	Streetligh...	78 %	0.550	Undefined Manufacturer: Protective Plate, Glass
XP-G2	Asymmetric deg	Streetligh...	94 %	1.200	-
XP-L2	Asymmetric deg	Streetligh...	94 %	0.750	-
XP-G3	sim: Asymmetri	Streetligh...	sim: 90 %	sim: 0.760	-
XD16	Asymmetric deg	Streetligh...	94 %	1.100	-
XD16 2x2 cluster	Asymmetric deg	Streetligh...	94 %	0.750	-
H35C1 (LEMWA33)	sim: Asymmetri	Streetligh...	sim: 91 %	sim: 0.740	-
H35C1 (LEMWA33)	Asymmetric deg	Streetligh...	94 %	1.100	-
LUXEON 5258	sim: Asymmetri	Streetligh...	-	-	-
LUXEON TX	Asymmetric deg	Streetligh...	94 %	1.040	-
LUXEON 5050	Asymmetric deg	Streetligh...	94 %	0.660	-
LUXEON V	Asymmetric deg	Streetligh...	94 %	0.800	-
NVSxx19B/NVSxx19C	sim: Asymmetri	Streetligh...	sim: 87 %	sim: 0.830	-
NVSx21A	Asymmetric deg	Streetligh...	94 %	0.380	-
NVSW3x9A	Asymmetric deg	Streetligh...	94 %	0.930	-



PRODUCT DATASHEET

Strada series

last update 21/4/2016

OPTICAL PROPERTIES

LED	Viewing Angle	Light Beam	Efficiency	cd/lm	Connector
NVSxx19B/NVSxx19C	sim: Asymmetric	Streetlight	sim: 69 %	sim: 0.510	Undefined Manufacturer: Protective Plate, Glass
Duris S8	sim: Asymmetric	Streetlight	sim: 92 %	sim: 0.620	-
Oslo Square PC	Asymmetric	deg Streetlight	94 %	0.900	-
Oslo Square Gen3	Asymmetric	deg Streetlight	94 %	1.100	-
OSCONIQ P 3737 (3W version)	sim: Asymmetric	Streetlight	sim: 91 %	sim: 0.710	-
PrevaLED Brick DC 2x8	Asymmetric	deg Streetlight	94 %	1.100	-
Fortimo FastFlex LED board 2x8 DA G4	Asymmetric	deg Streetlight	94 %	1.000	-
Fortimo FastFlex LED board 2x8 DAX G4	sim: Asymmetric	Streetlight	sim: 90 %	sim: 0.760	-
LH351B	Asymmetric	deg Streetlight	94 %	0.860	-
LH351D	Asymmetric	deg Streetlight	93 %	0.740	-
LH351C	Asymmetric	deg Streetlight	94 %	0.900	-
LH508A	Asymmetric	deg Streetlight	94 %	0.700	-
LH181B	sim: Asymmetric	Streetlight	sim: 92 %	sim: 0.830	-
Z5M1/Z5M2	sim: Asymmetric	Streetlight	-	-	-
Z8Y22P	Asymmetric	deg Streetlight	94 %	0.960	-
Z8Y22	Asymmetric	deg Streetlight	94 %	0.870	-
TL1L4	sim: Asymmetric	Streetlight	-	-	-
RLE G1 49x223mm 4000lm xxx EXC OT	Asymmetric	deg Streetlight	94 %	0.900	-
RLE G1 49x245mm 4000lm xxx EXC OT	Asymmetric	deg Streetlight	94 %	0.900	-
RLE G1 49x121mm 2000lm xxx EXC OT	Asymmetric	deg Streetlight	94 %	0.900	-
RLE G1 49x133mm 2000lm xxx EXC OT	Asymmetric	deg Streetlight	94 %	0.900	-

D

C

B

A

4

4

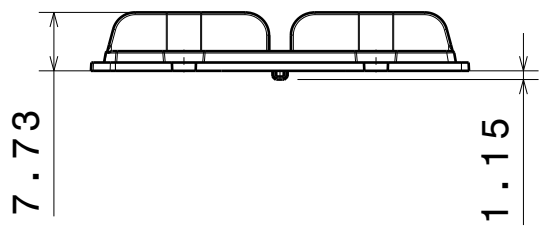

Front view

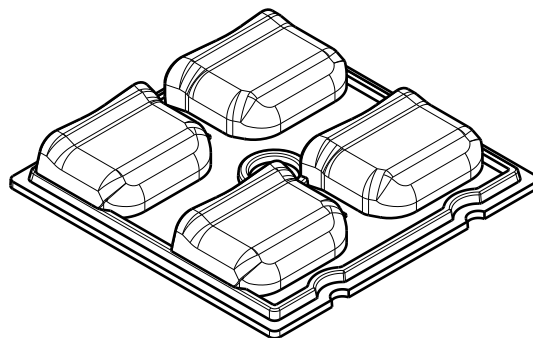

Isometric view

Scale: 1:1

Beam direction

3

3

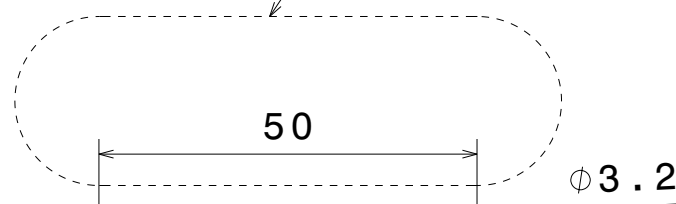

Top view

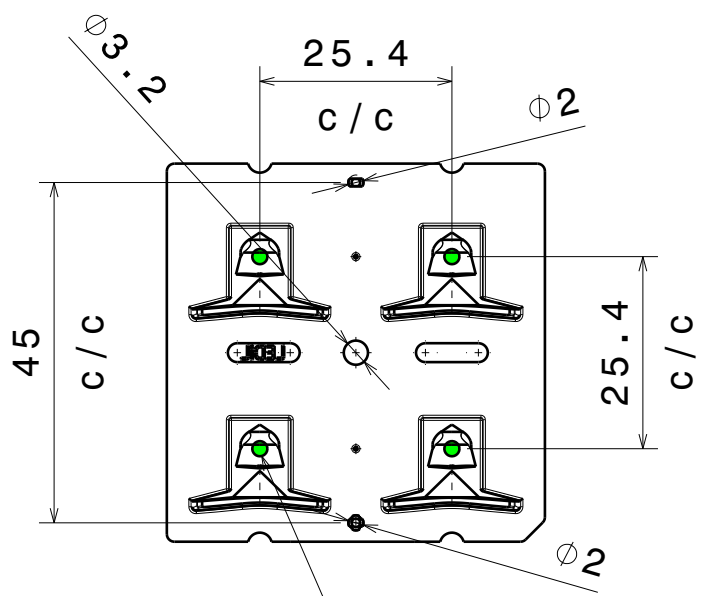

Bottom view

LED middle position

2

2

INDEX	PART NO	DESCRIPTION	MATERIAL	COLOUR
1	C15021	STRADA-2X2-SCL	PMMA	

Tolerances if not otherwise shown
 According to DIN ISO 2768-1
 Linear measures:
 up to 30mm class M, otherwise class C
 According to DIN ISO 2768-2
 Form and position: class L

LEDiL Ledil Oy
 Salorankatu 10
 FIN 24240 SALO
 Finland

THIRD ANGLE PROJECTION:

DRAWING TITLE
C15021_STRADA-2X2-SCL

This drawing is the property of LEDiL Oy. It may not be reproduced, copied or communicated without a written agreement with LEDiL Oy.

SIZE	PART NUMBER
A4	C15021

SCALE	1:1	WEIGHT	9,35 g	SHEET	1/1
-------	-----	--------	--------	-------	-----

1

1

D

A

Luminaire: LEDiL Oy C15021_STRADA-2X2-SCL_(Bridgelux_5050_Gen2)
Lamps: 1 x Bridgelux_5050_Gen2_2x2_(BXEP-57C-435-09B)_1447.45lm@250mA_CCT=5700K_P=8.29761W_I=0.25A

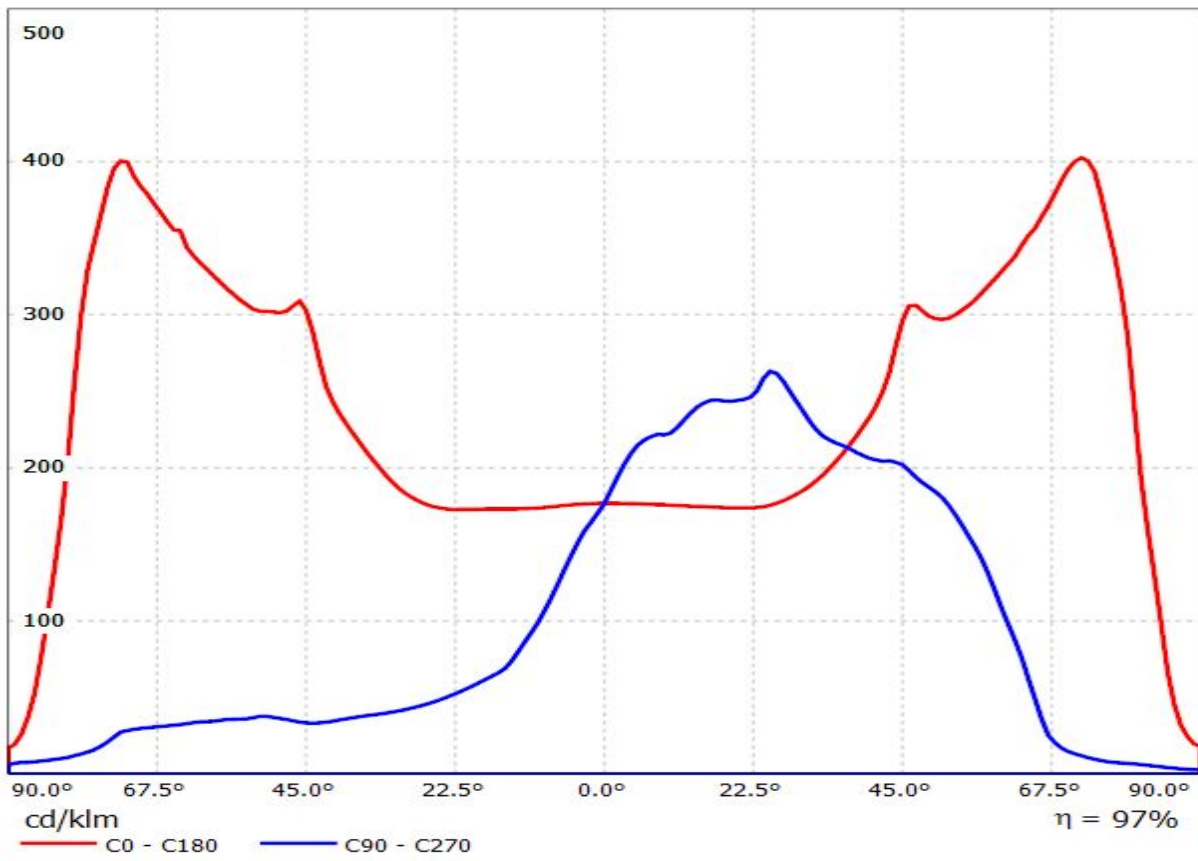

Luminaire: Ledil C15021_STRADA-2X2-SCL (XTP_2x4_740_LS_G5)

Lamps: 1 x QUICK_FLUX_XTP_2x4_740_LS_G5_967.825lm@0.250mA_P=5.71896W_I=250A

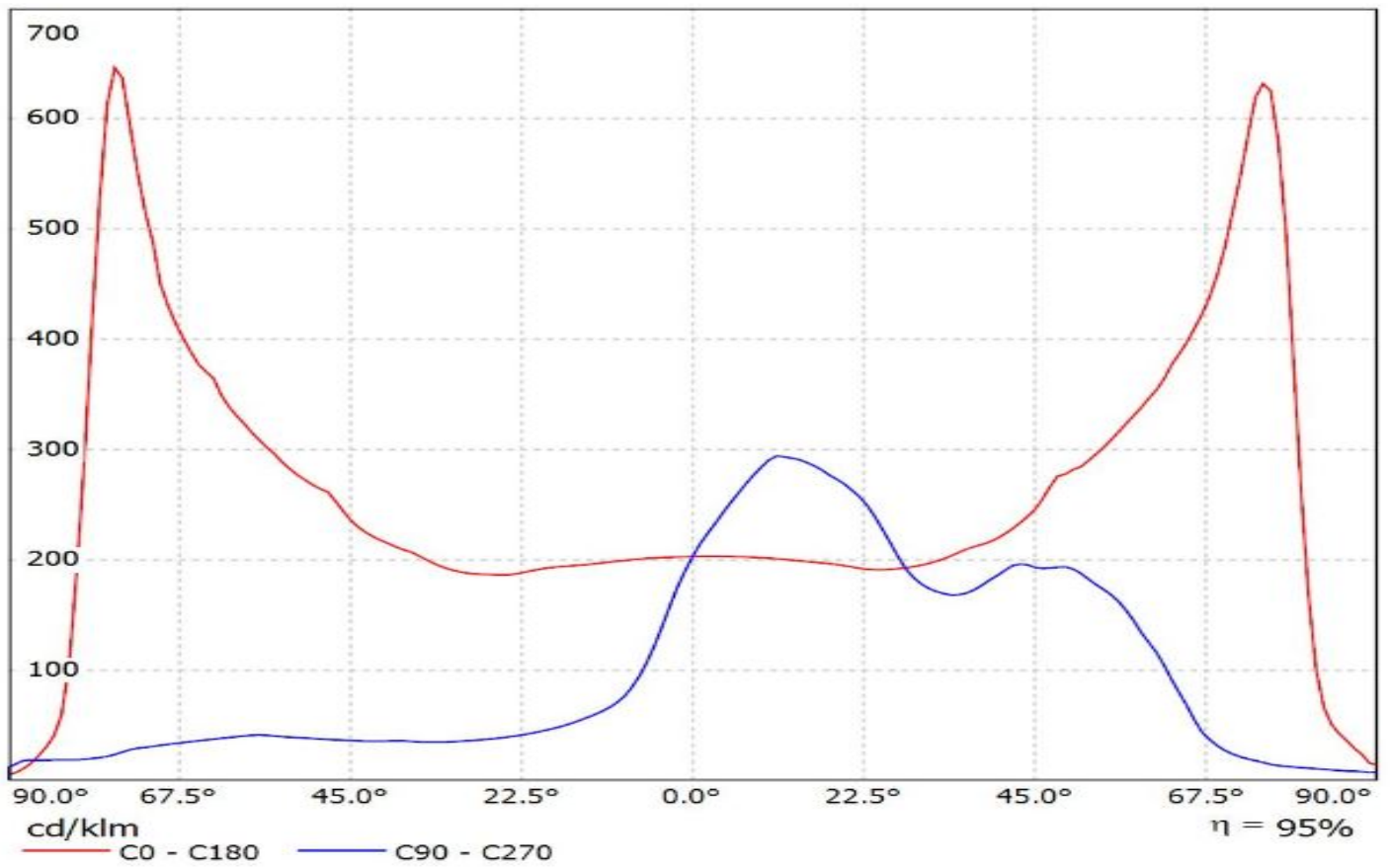

Luminaire: Ledil C15021_STRADA-2X2-SCL_(QUICK_FLUX_XTP_2x6_740_LS_G5)
Lamps: 1 x QUICK_FLUX_XTP_2x6_740_LS_G5_1450.62lm@0.250mA_P=8.59856W_I=250A

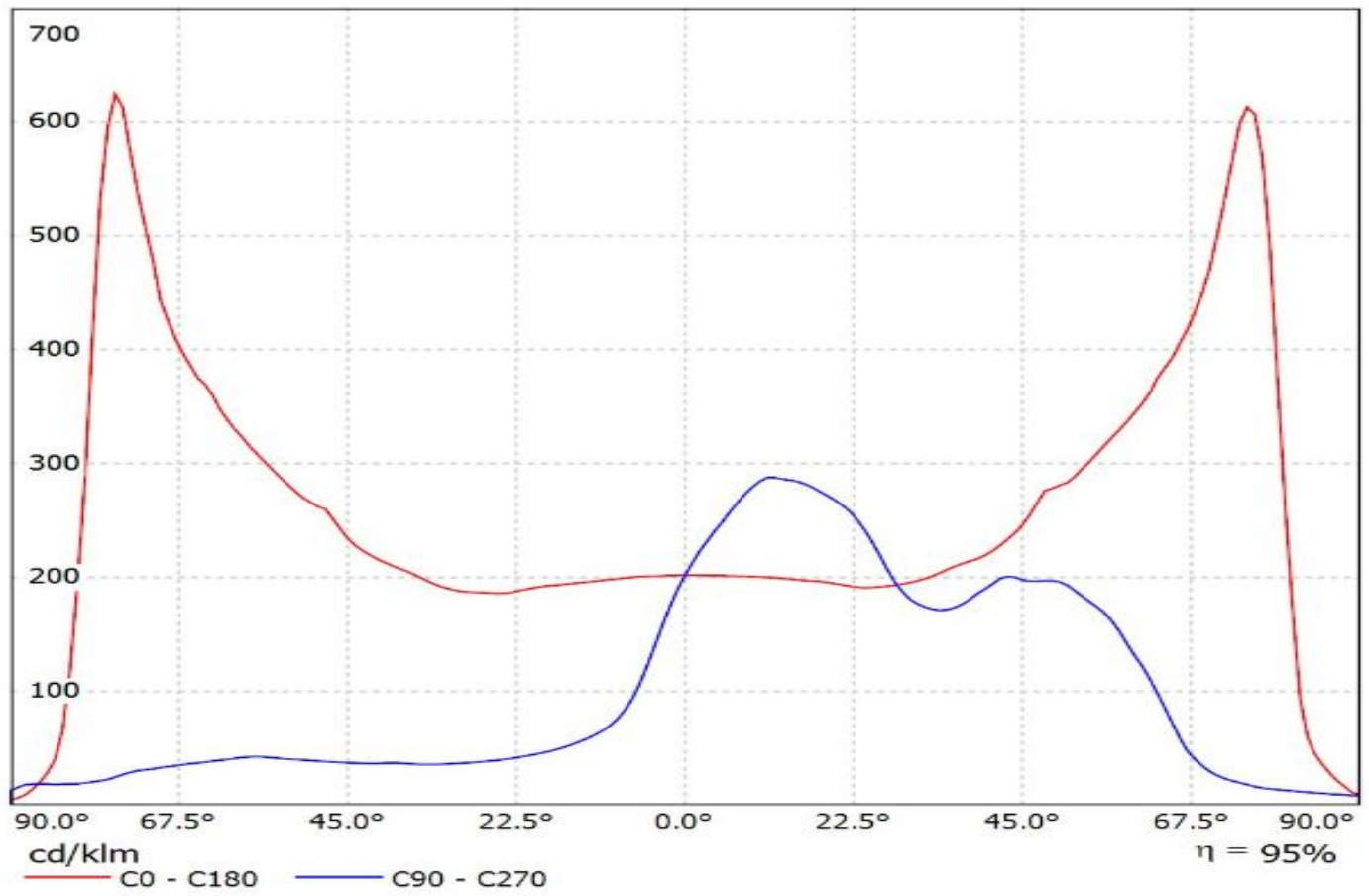

Luminaire: Ledil C15021_STRADA-2X2-SCL_(QUICK_FLUX_XTP_2x8_740_LS_G5)
Lamps: 1 x QUICK_FLUX_XTP_2x8_740_LS_G5_1923.68lm@250mA_P=11.4189W_I=0.25A

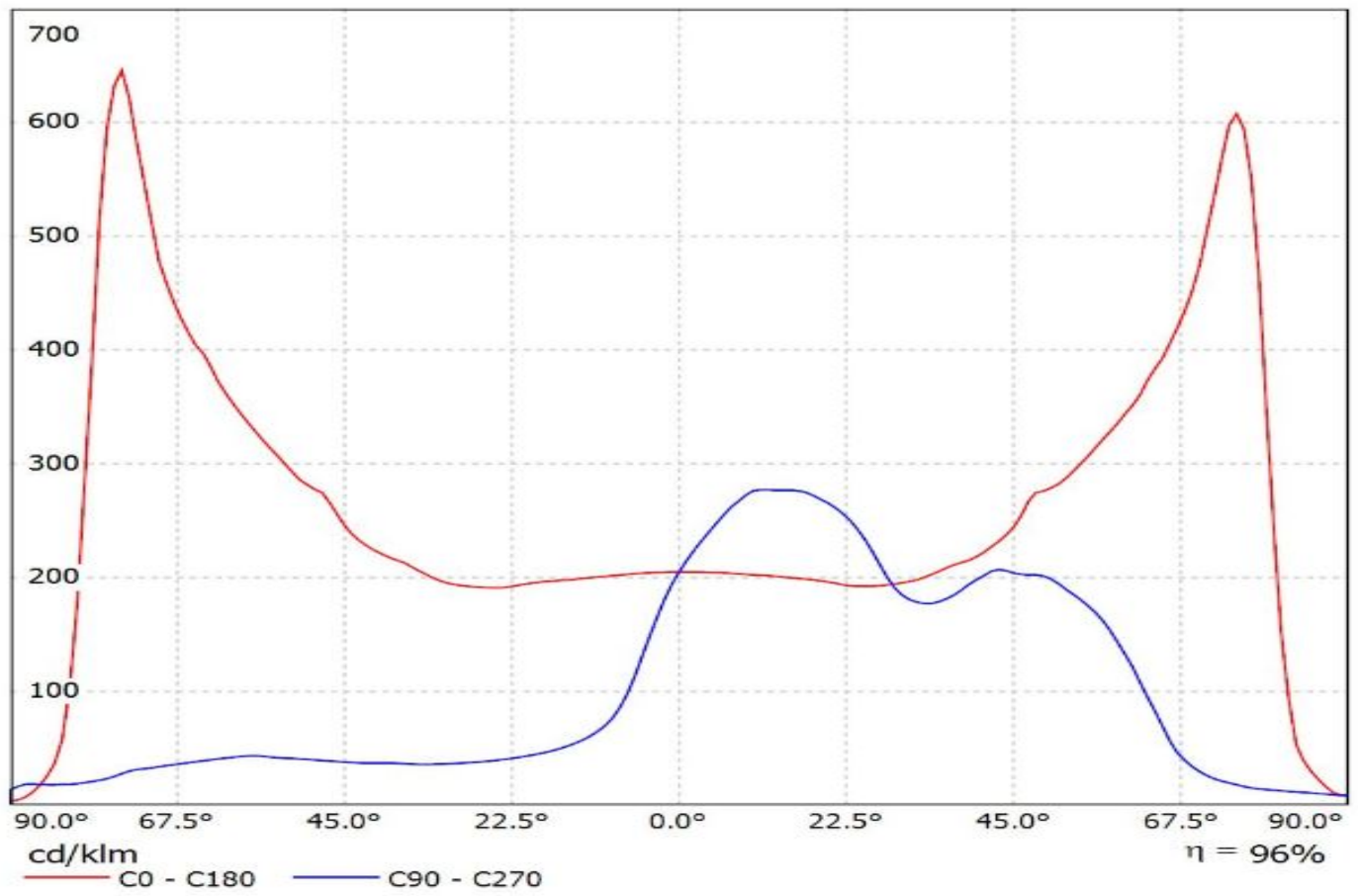

Luminaire: SIMULATED_C15021_STRADA-2X2-SCL_Cree_XB-H
Lamps: 1 x

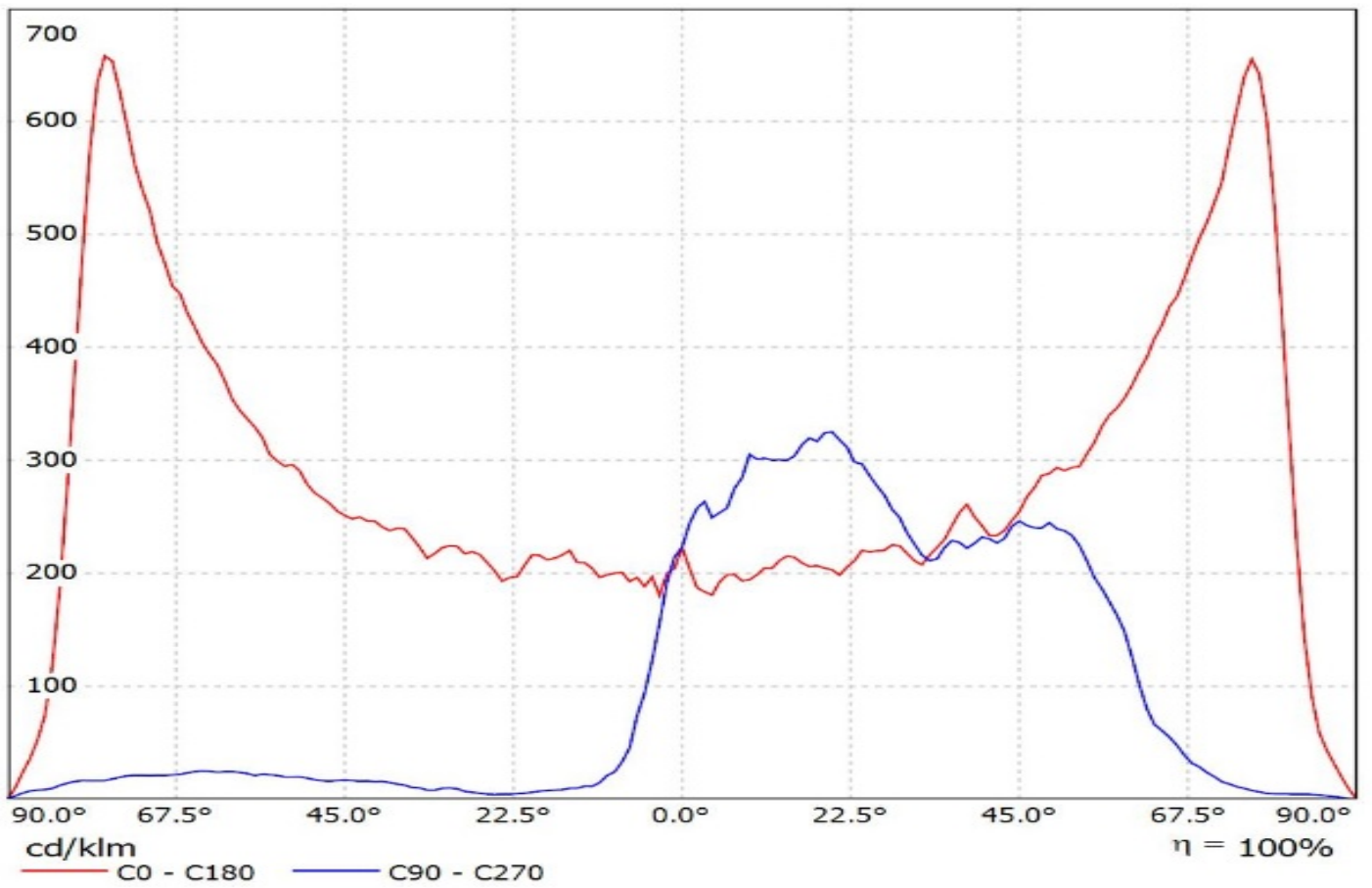

Luminaire: SIMULATED_C15021_STRADA-2X2-SCL_Cree_XHP35
Lamps: 1 x

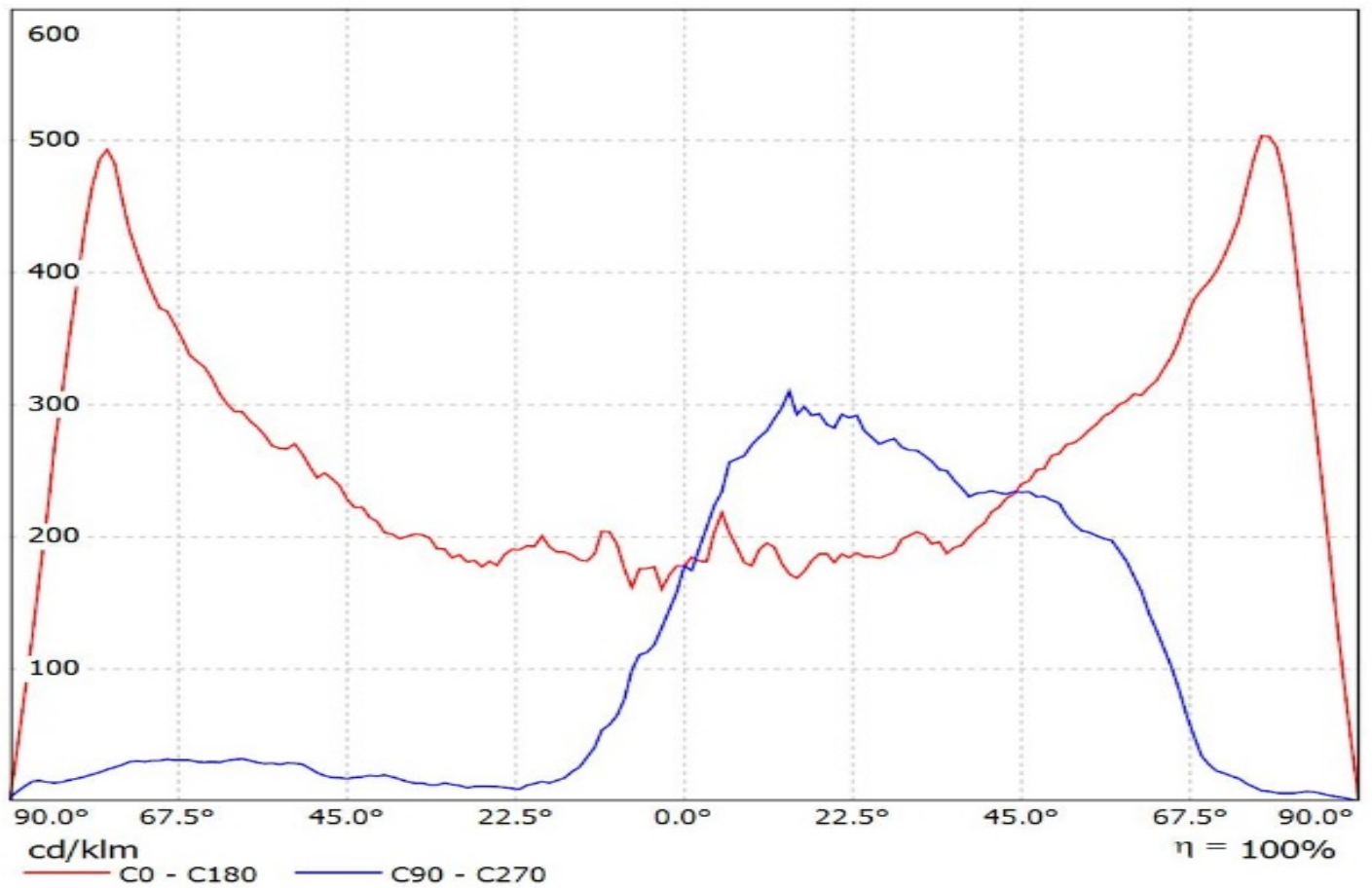

Luminaire: SIMULATED_C15021_STRADA-2X2-SCL_Cree_XM-L2
Lamps: 1 x

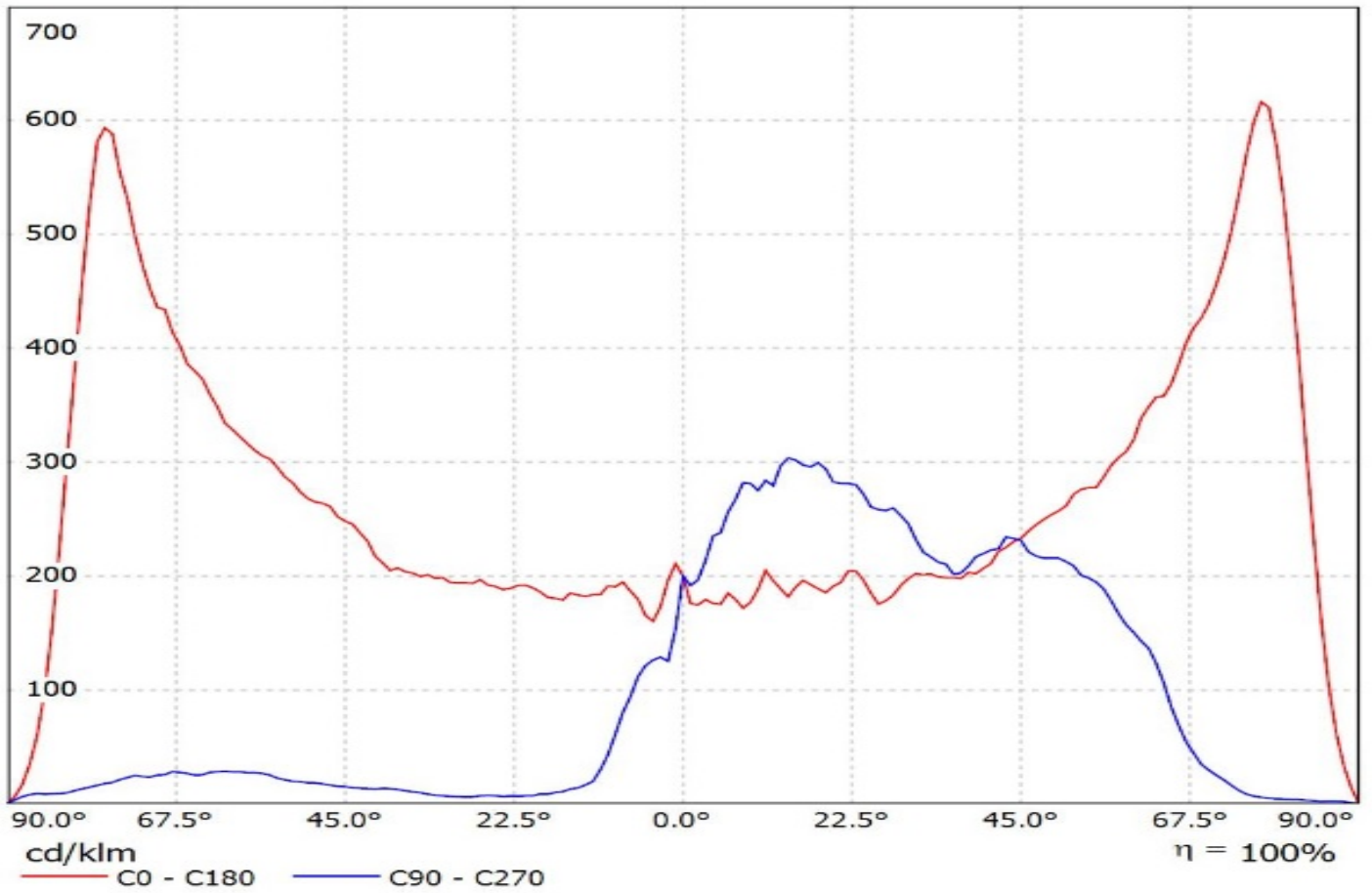

Luminaire: Ledil C15021_STRADA-2X2-SCL_(XP-L)
Lamps: 1 x CREE_XP-L_2x2_(XPLAWT-0-1B0-V40-00-0001)
_508.286lm@250mA_CCT=7600K_P=2.8173W_I=0.25A

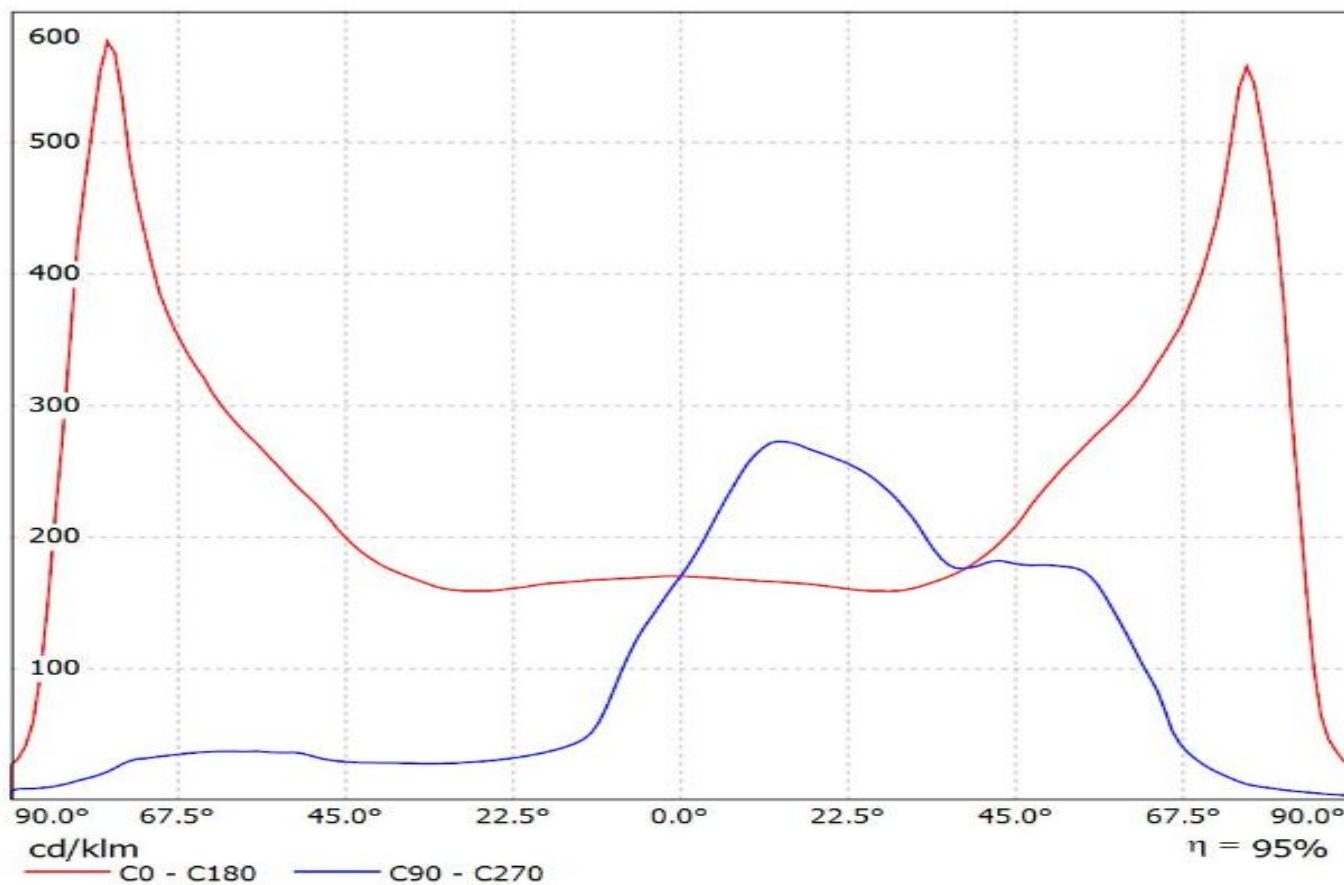

Luminaire: SIMULATED_C15021_STRADA-2X2-SCL_Cree_XP-L-HI
Lamps: 1 x

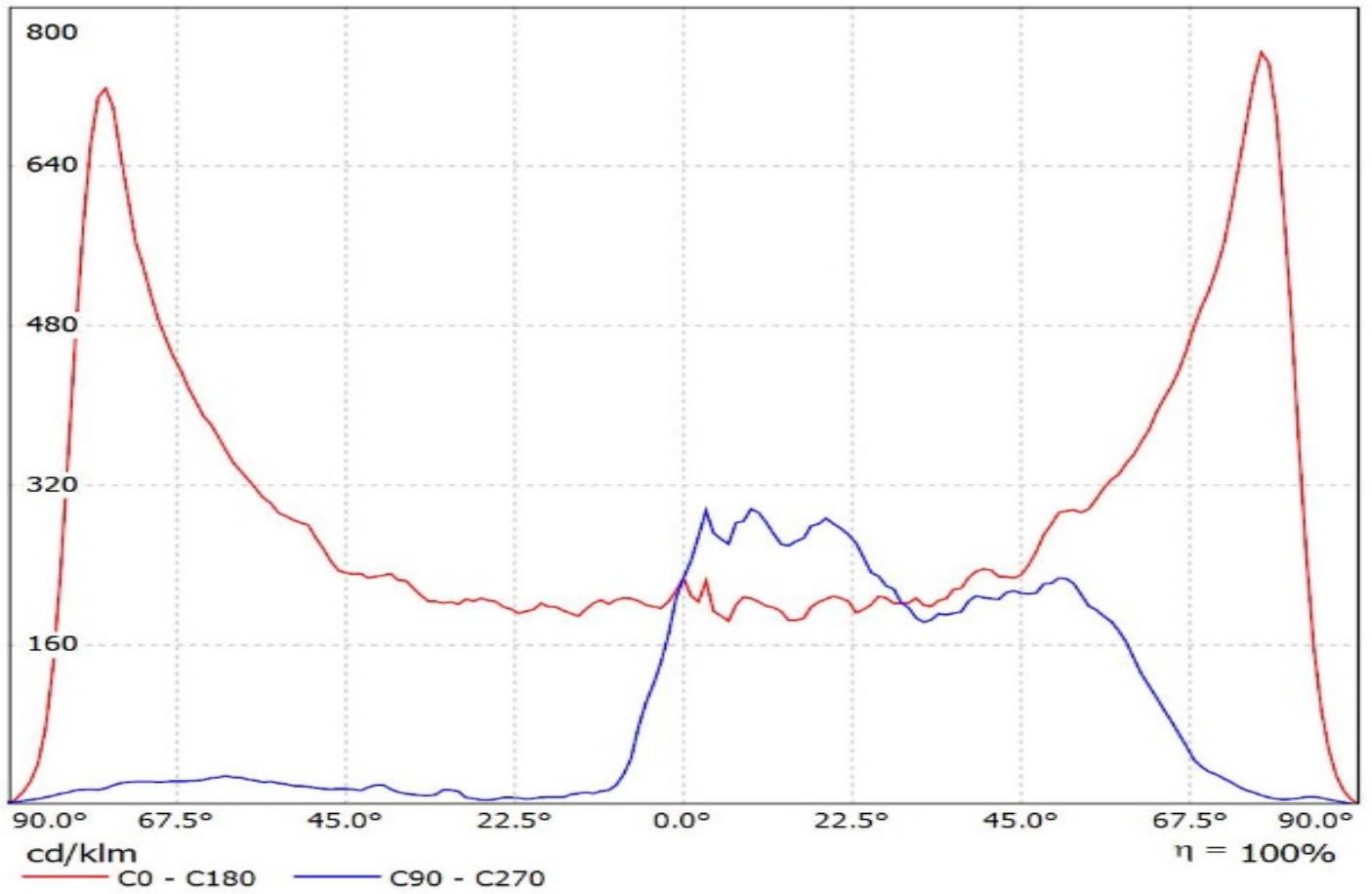

Luminaire: Ledil C15021_STRADA-2X2-SCL (XP-L)_glass
Lamps: 1 x CREE_XP-L_2x2_(XPLAWT-0-1B0-V40-00-0001)
_508.286lm@250mA_CCT=7600K_P=2.8173W_I=0.25A

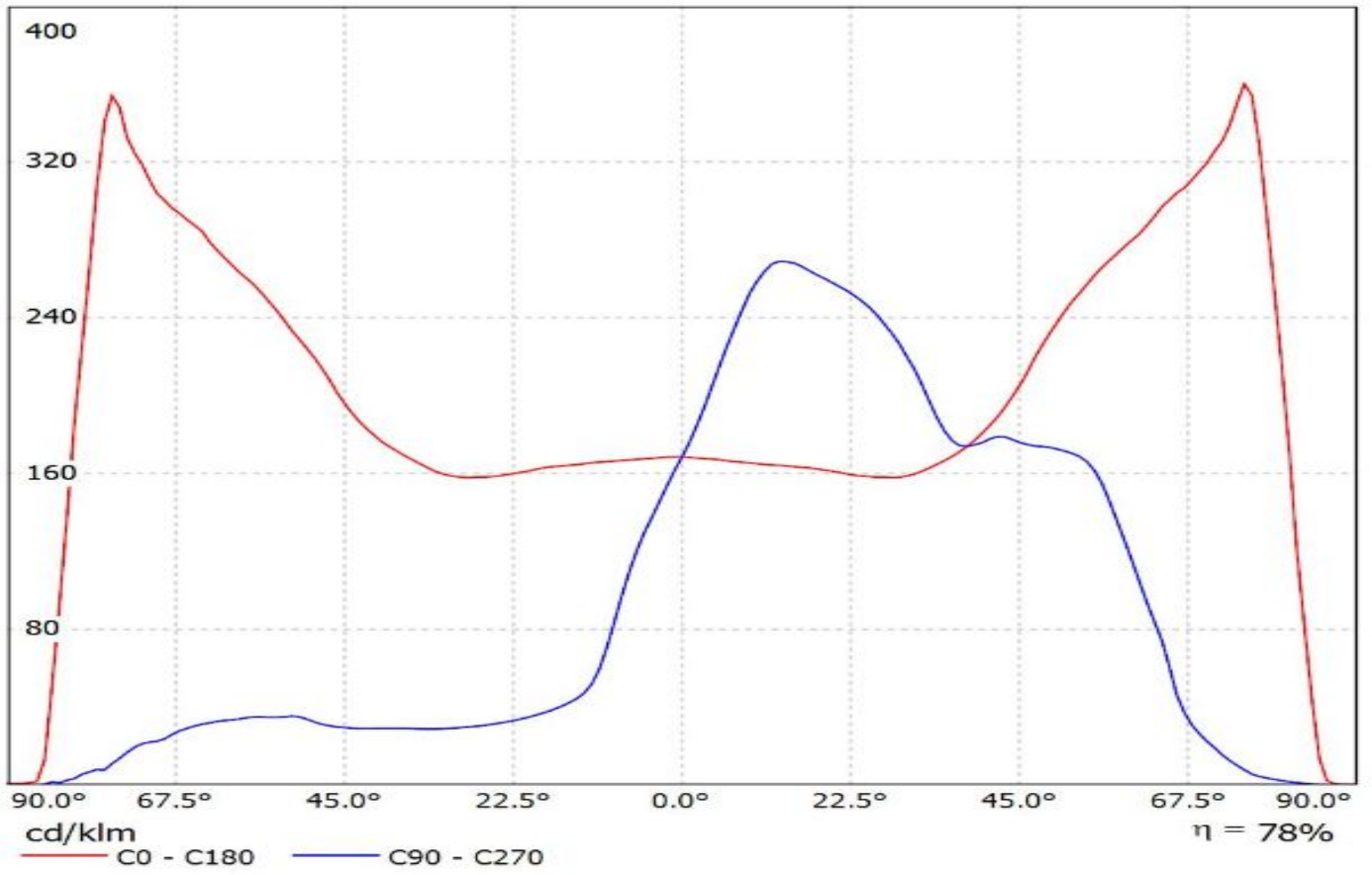

Luminaire: LEDiL Oy C15021_STRADA-2X2-SCL_(XP-G2)
Lamps: 1 x Cree_XP-G2_(XPGBWT-L1-000-00-G51)_409.845lm@250mA_P=2.94464_I=0.250A

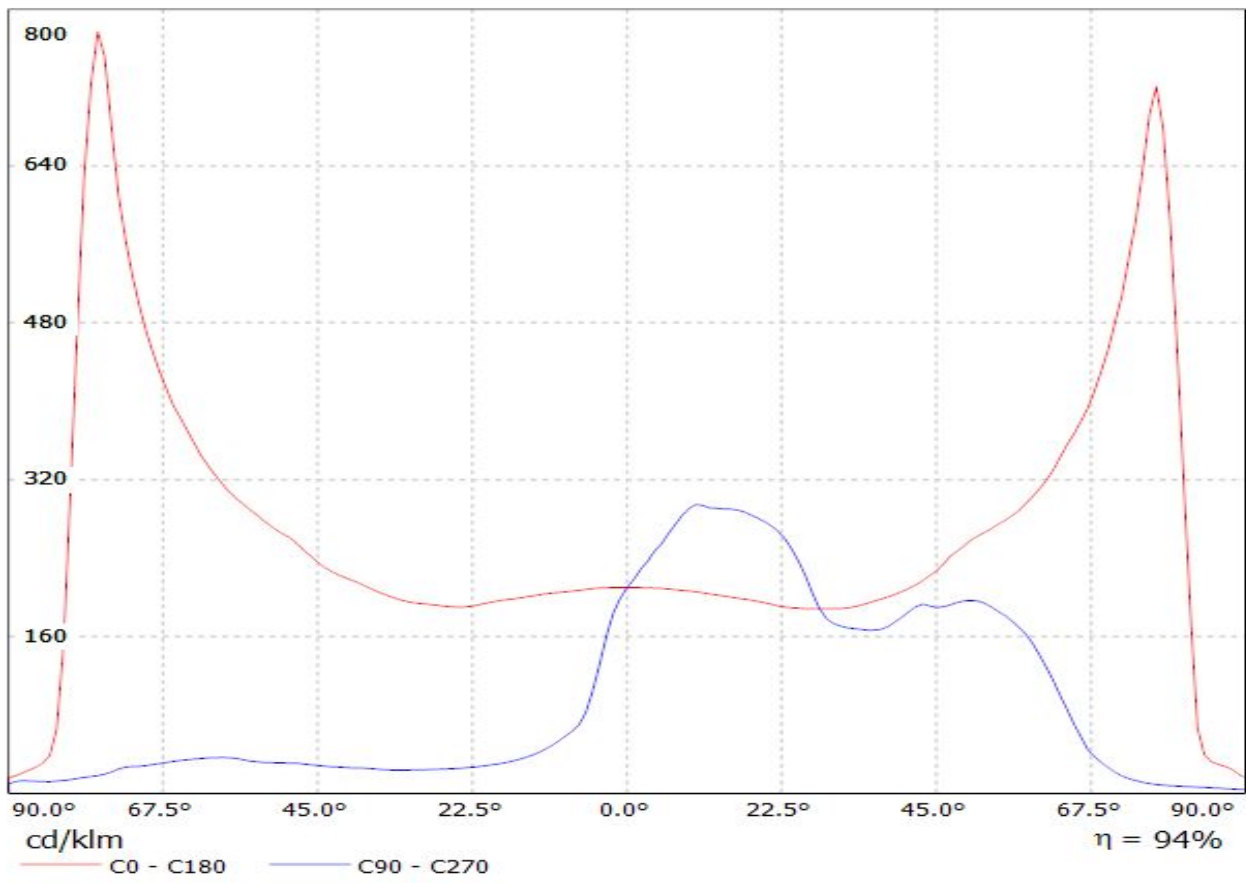

Luminaire: Ledil C15021_STRADA-2X2-SCL_(XP-L2)

Lamps: 1 x Cree_XP-L2_2x2_(XPLBWT-00-0000-000BV50E3)550.93lm@250mA_P=2.7815W_I=0.25A

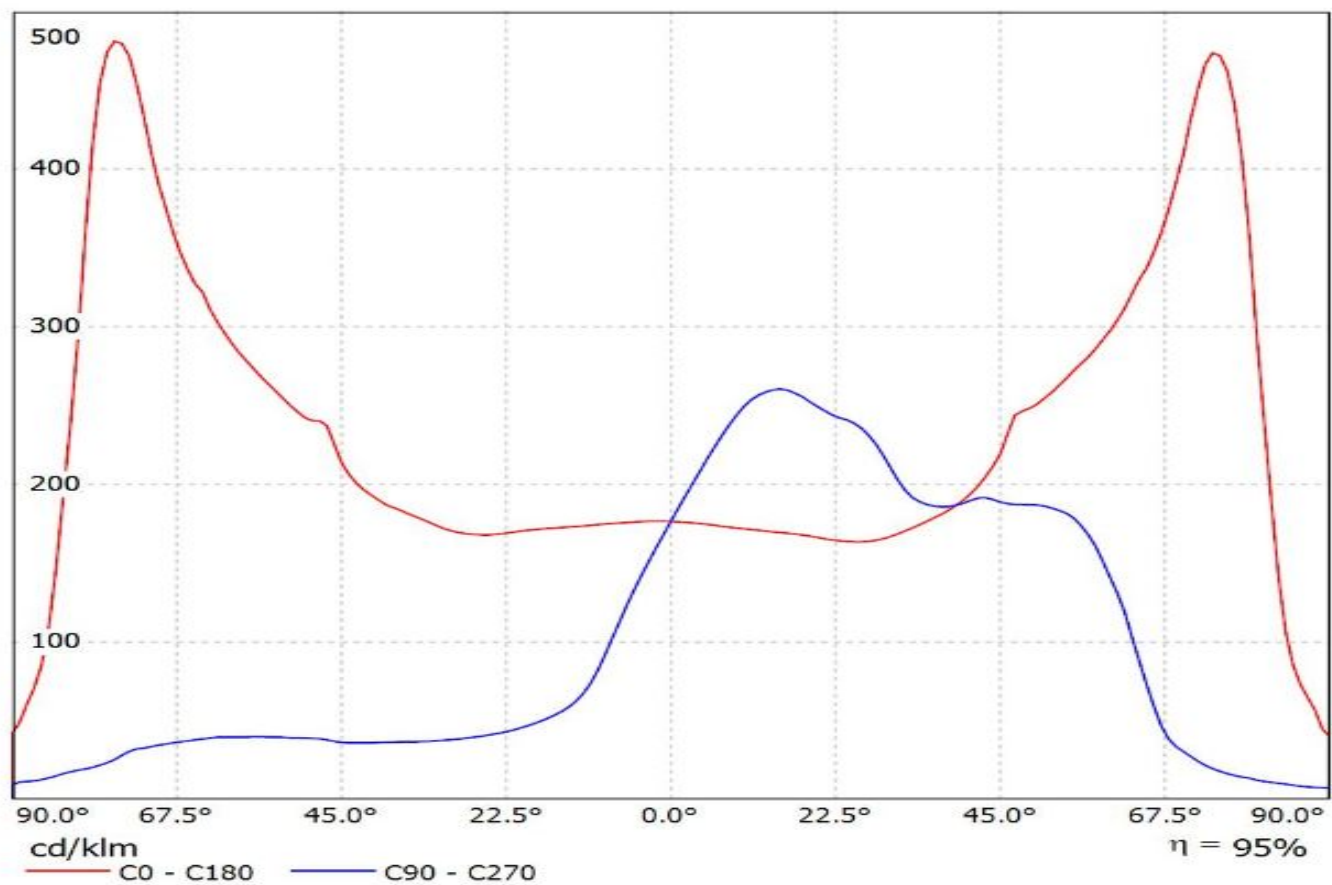

Luminaire: Ledil Oy C15021_STRADA-2X2-SCL_(XP-G3)_SIMULATED
Lamps: 1 x Cree XP-G3

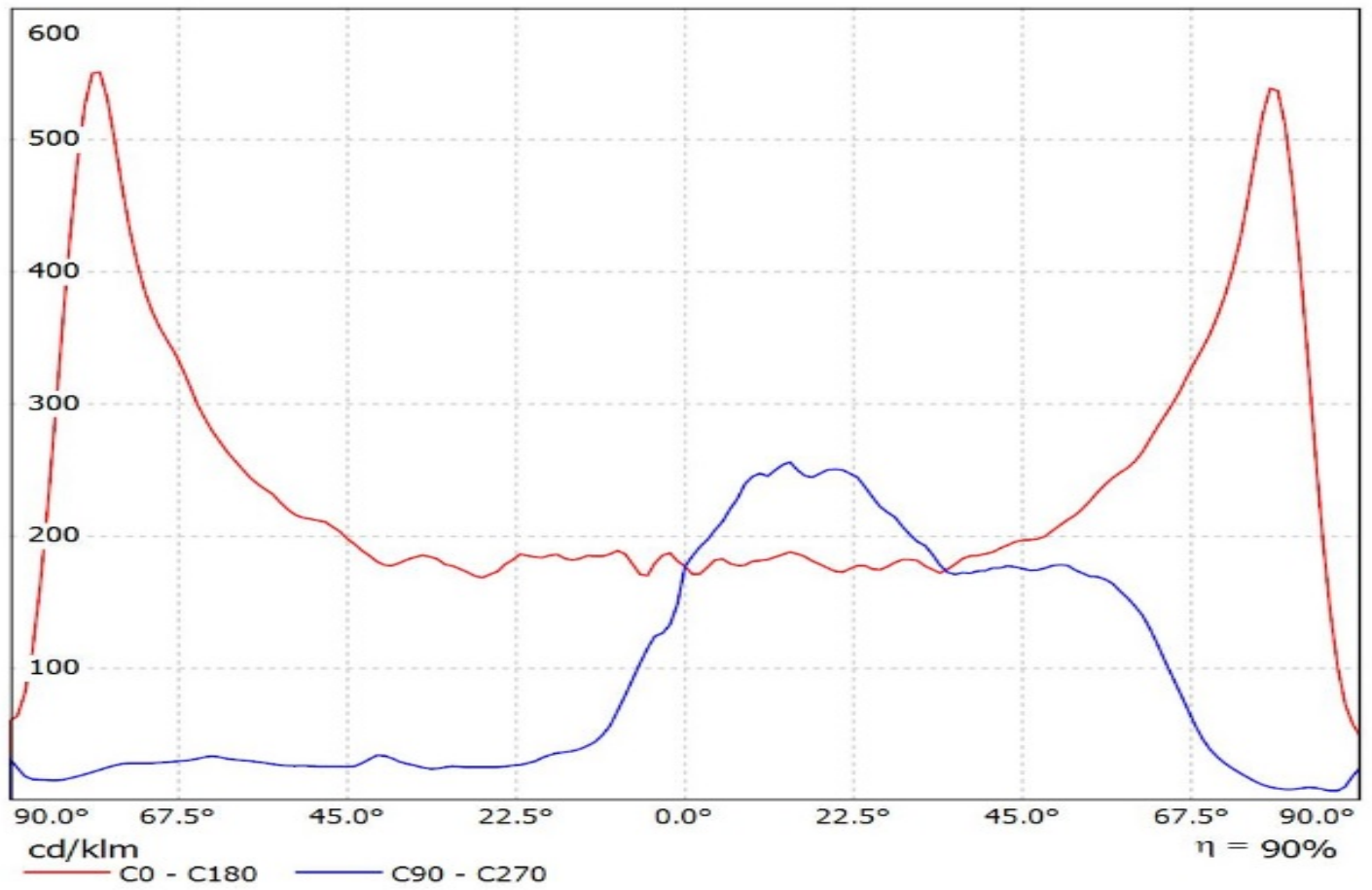

Luminaire: Ledil C15021_STRADA-2X2-SCL_XD16)

Lamps: 1 x Cree_XD16_2x2_(XD16AWT-H-2B0-S20-0B-002)_453.677lm@250mA_CCT=5700K_P=2.78289W_I=0.25A

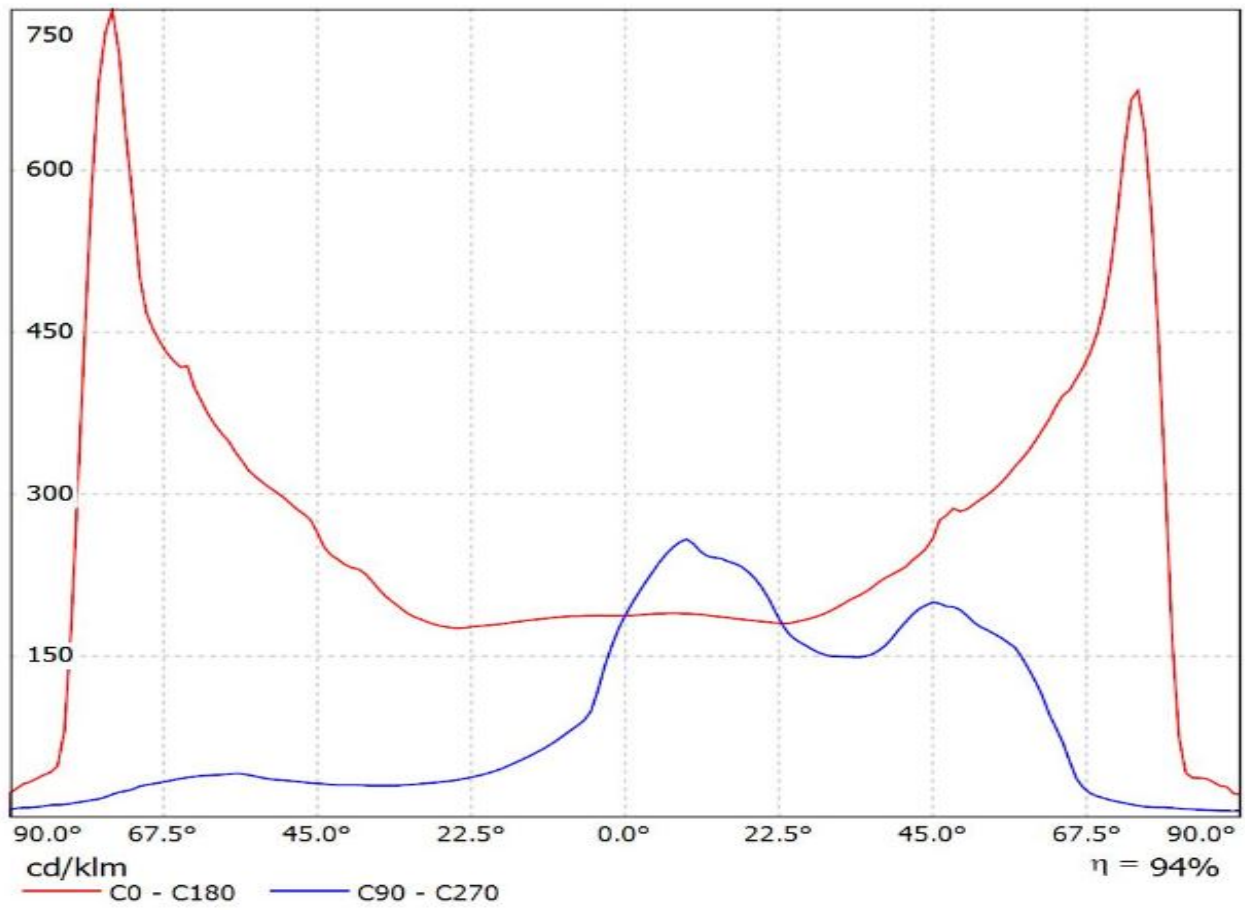

Luminaire: LEDiL Oy C15021_STRADA-2X2-SCL_(XD16_Cluster16)

Lamps: 1 x Cree_XD16_2x2cluster_(XD16AWT-H-2B0-S20-0B-002)_1763.39lm@250mA_CCT=5700K_P=10.926W_U=43.738V

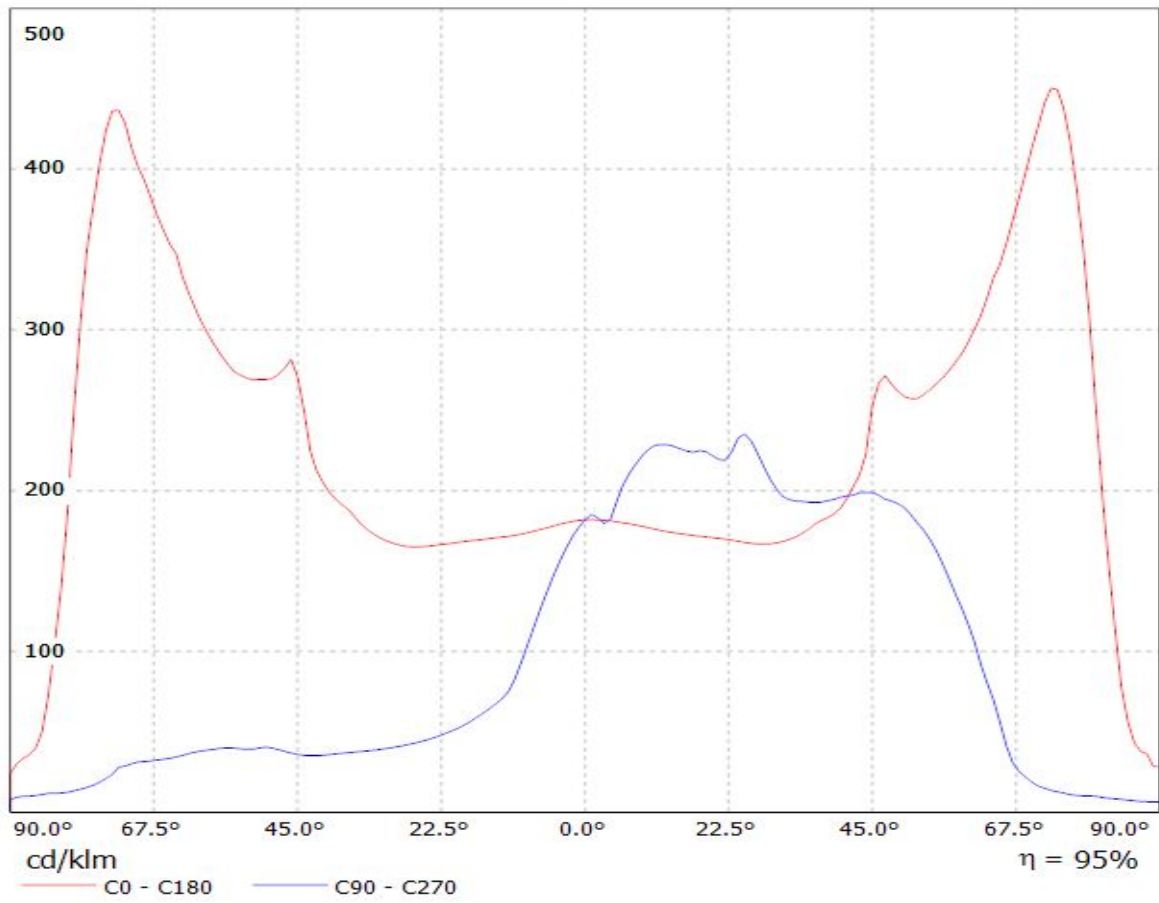

Luminaire: Ledil Oy C15021_STRADA-2X2-SCL_(H35C1)_SIMULATED
Lamps: 1 x LG H35C1 (CCT=5700K)

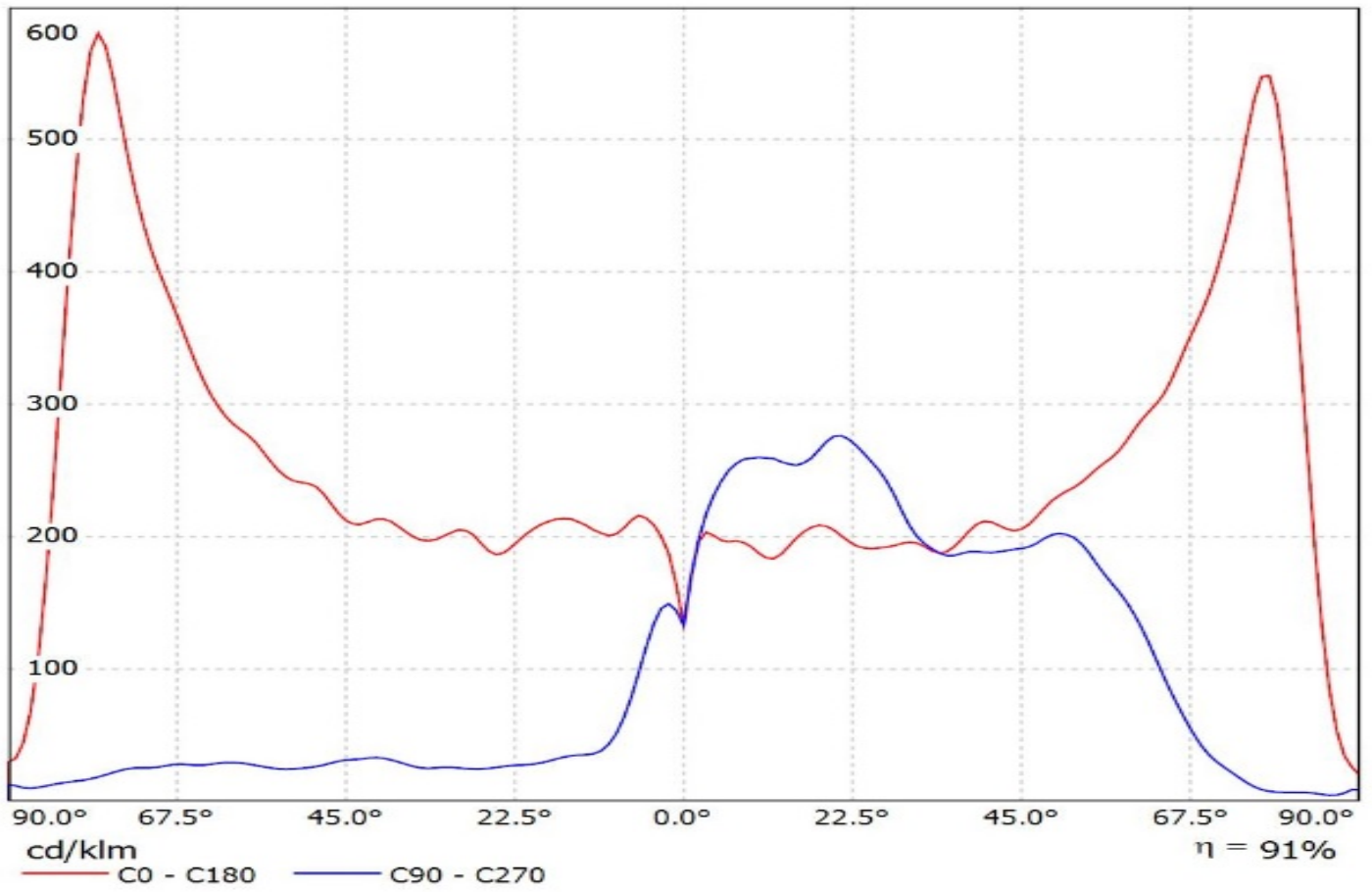

Luminaire: Ledil C15021_STRADA-2X2-SCL_(H35C1)
Lamps: 1 x LG_H35C1_2x2_477.216lm@250mA_P=2.87475W_I=0.250A

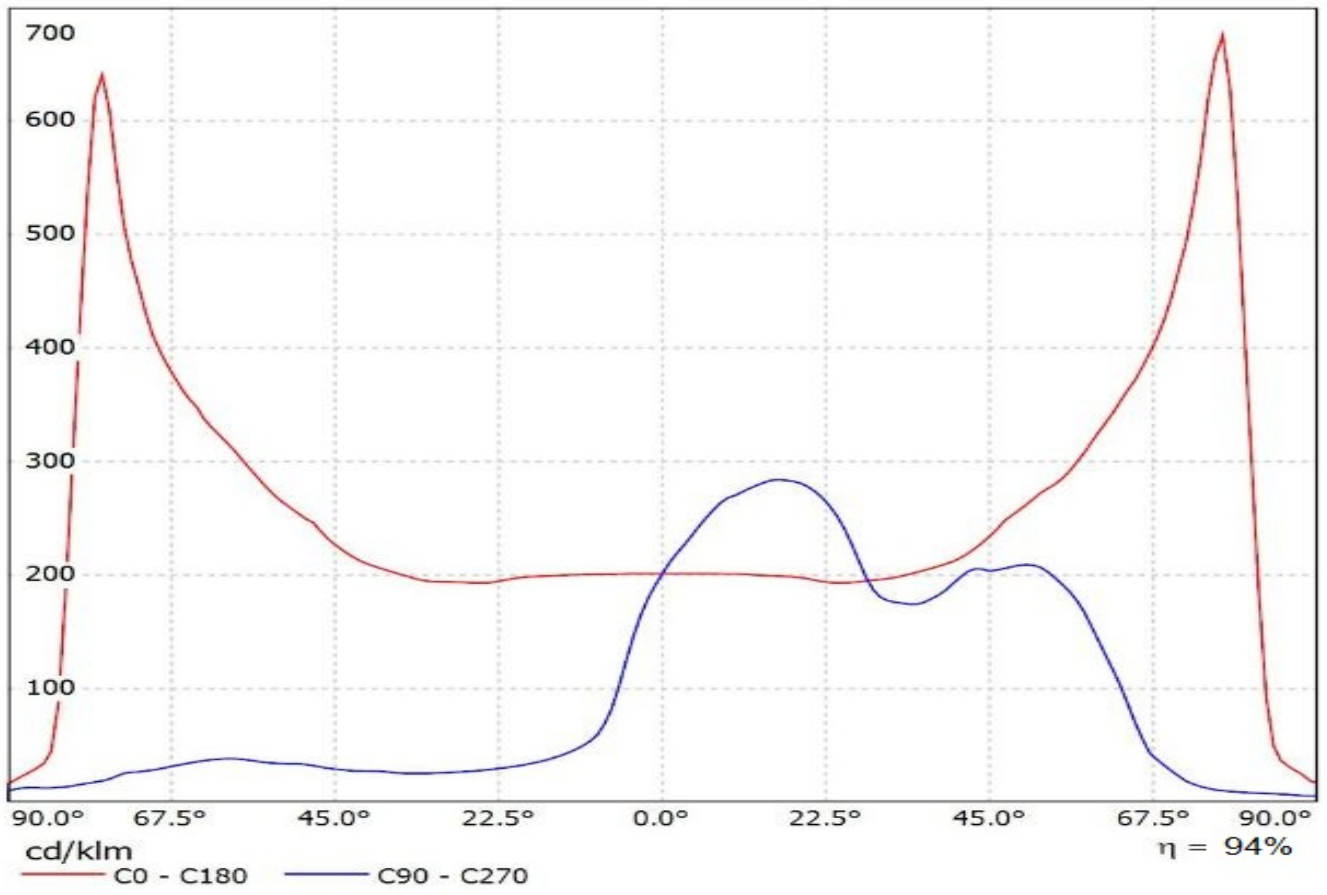

Luminaire: SIMULATED_C15021_STRADA-2X2-SCL_Luxeon-5258
Lamps: 1 x

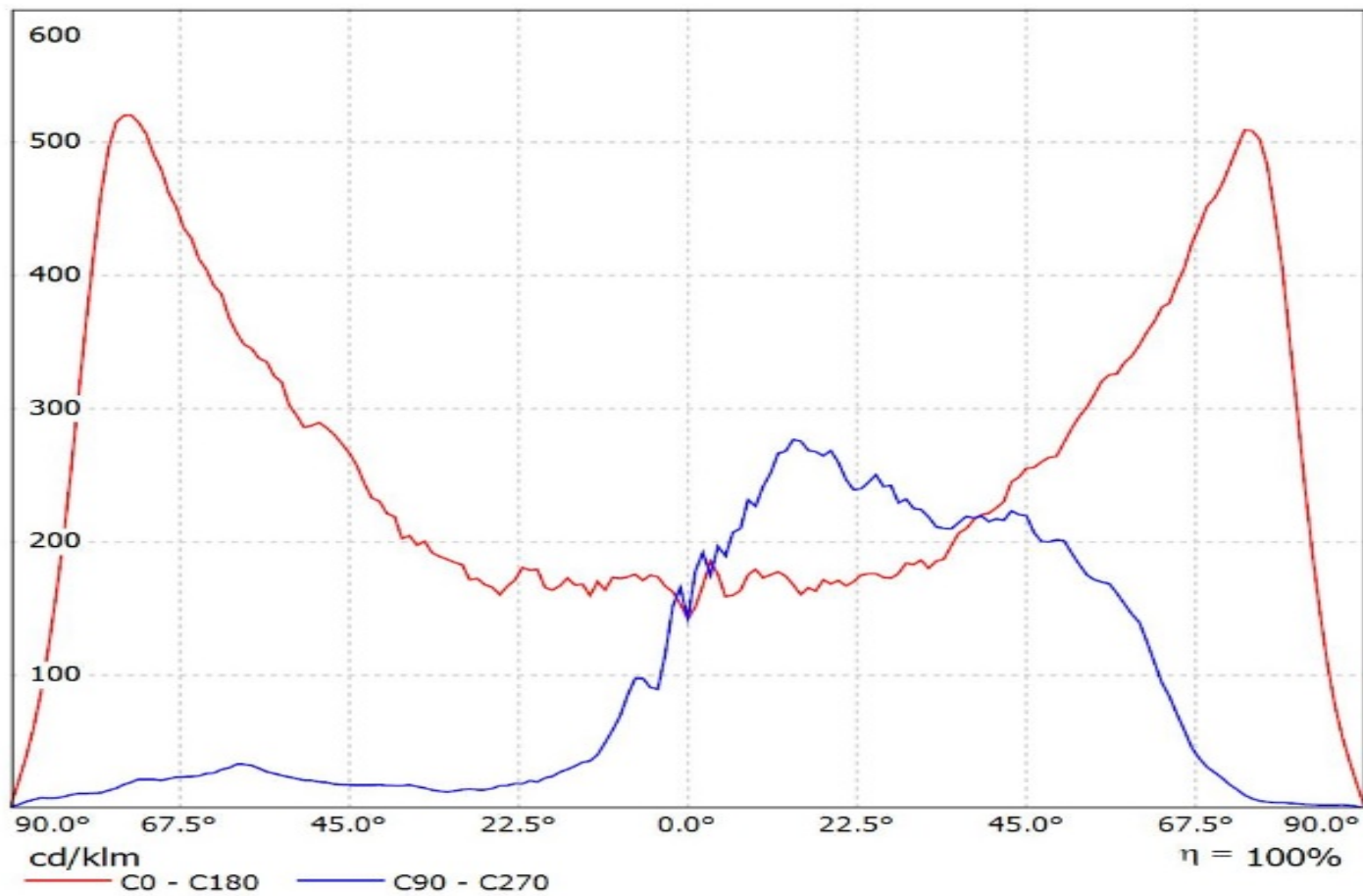

Luminaire: Ledil C15021_STRADA-2X2-SCL_(Luxeon_TX)
Lamps: 1 x Luxeon_TX_(L1T2-3585)_Im@250mA_P=W_I=0.250A

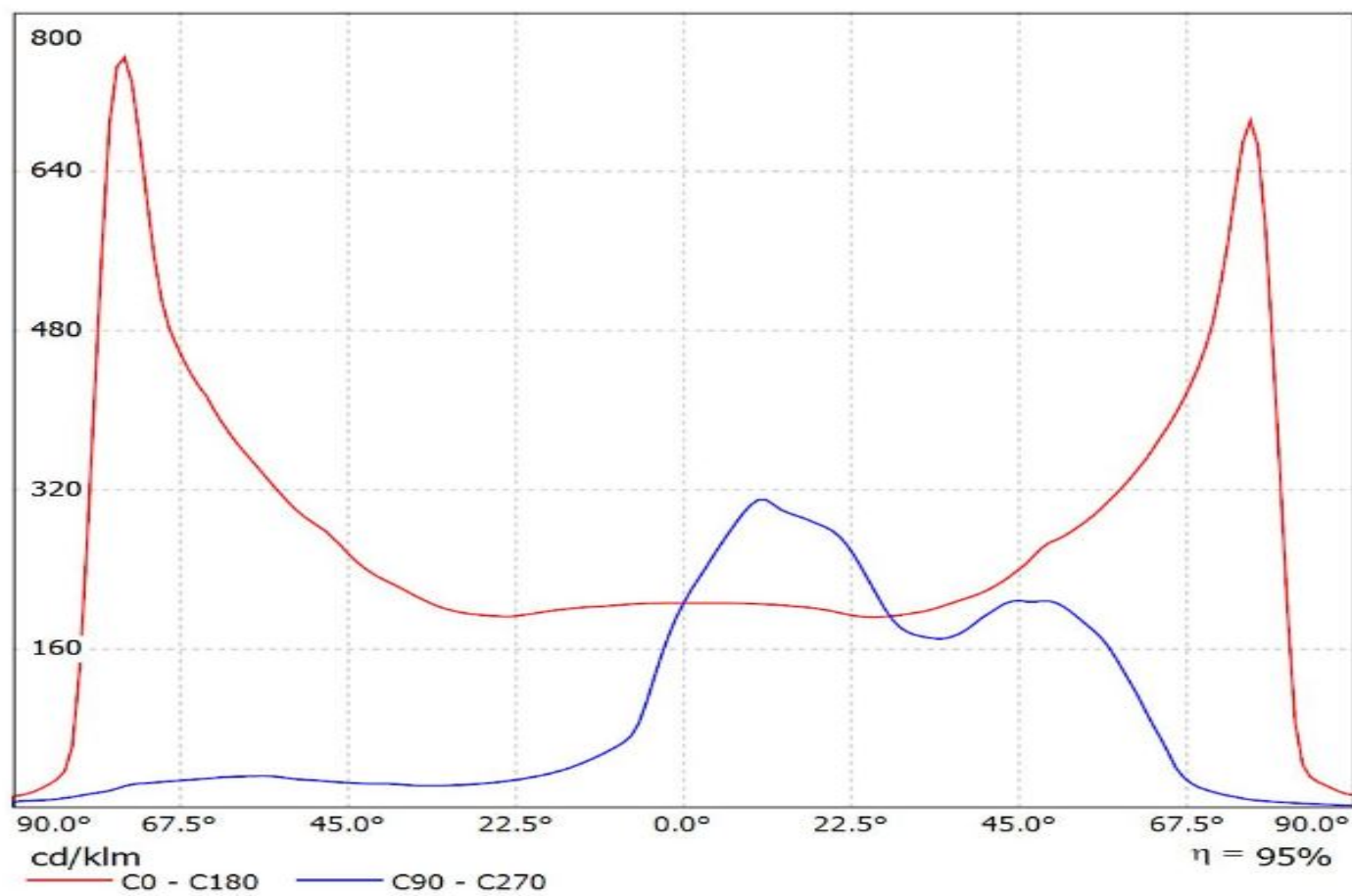

Luminaire: LEDiL Oy C15021_STRADA-2X2-SCL_(Luxeon_5050)

Lamps: 1 x Luxeon_5050_2x2_1270.76lm@80mA_CCT=5700K_P=7.35815W_I=0.080A_70CRI

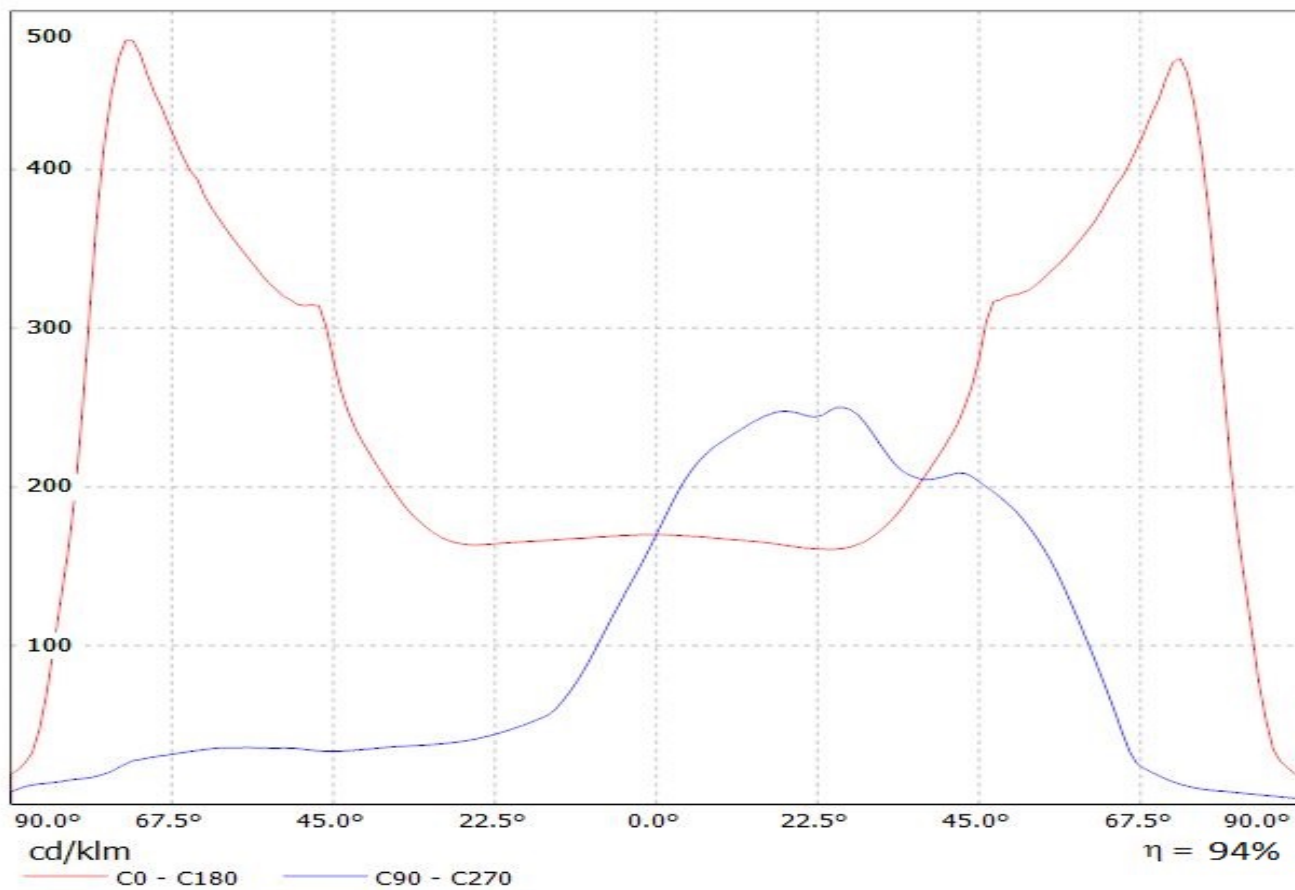

Luminaire: LEDiL Oy C15021_STRADA-2X2-SCL_(Luxeon_V)

Lamps: 1 x Lumileds_Luxeon_V_2x2_486.24lm@250mA_CCT=4000K_P=2.7538W_I=0.250A

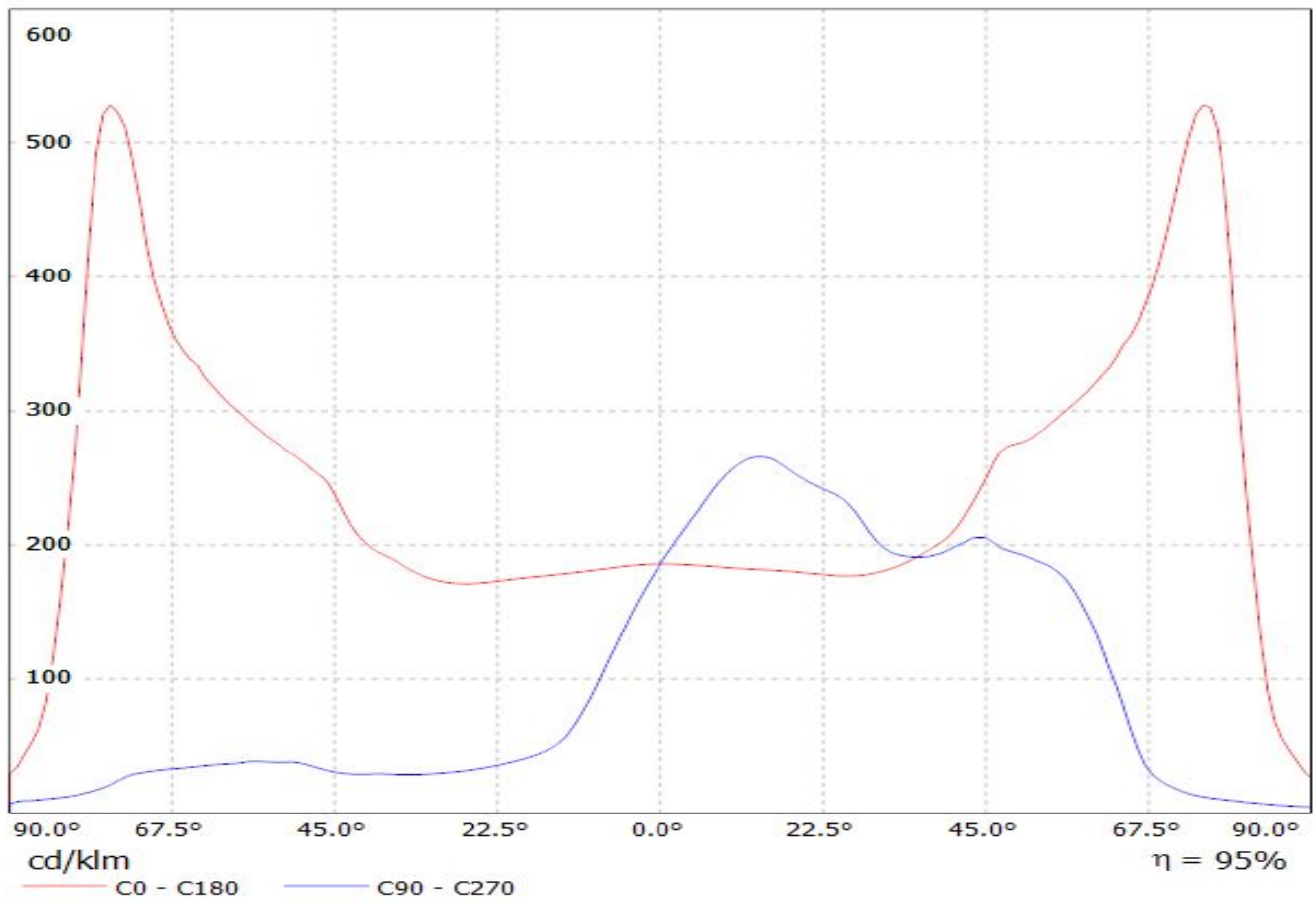

Luminaire: Ledil Oy C15021_STRADA-2X2-SCL_(NVSxx19C)_SIMULATED
Lamps: 1 x Nichia NVSxx19C

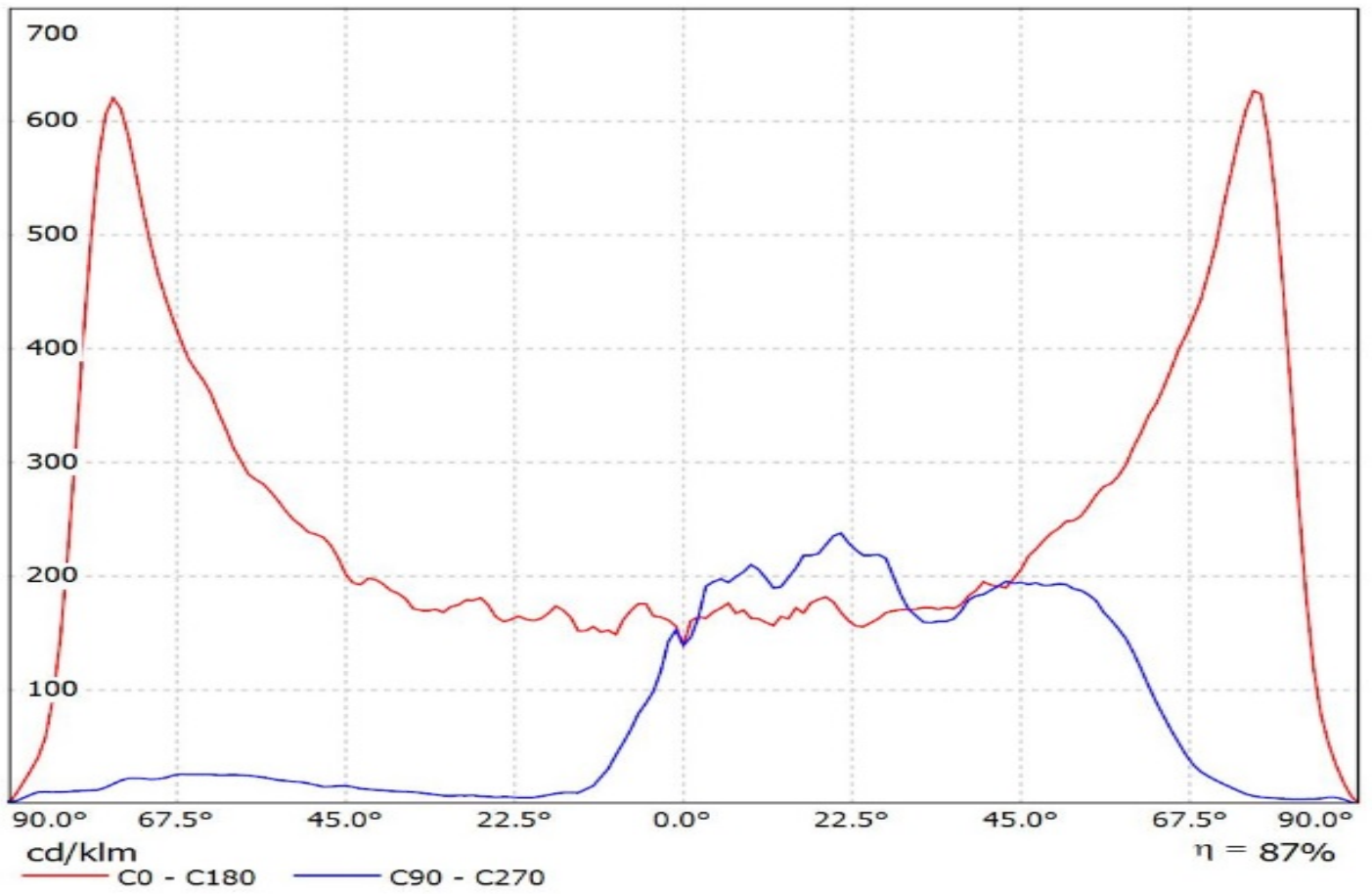

Luminaire: LEDiL Oy C15021_STRADA-2X2-SCL_(E21A)
Lamps: 1 x Nichia_E21A_452.248lm@250mA_2.805W_I=0.250A

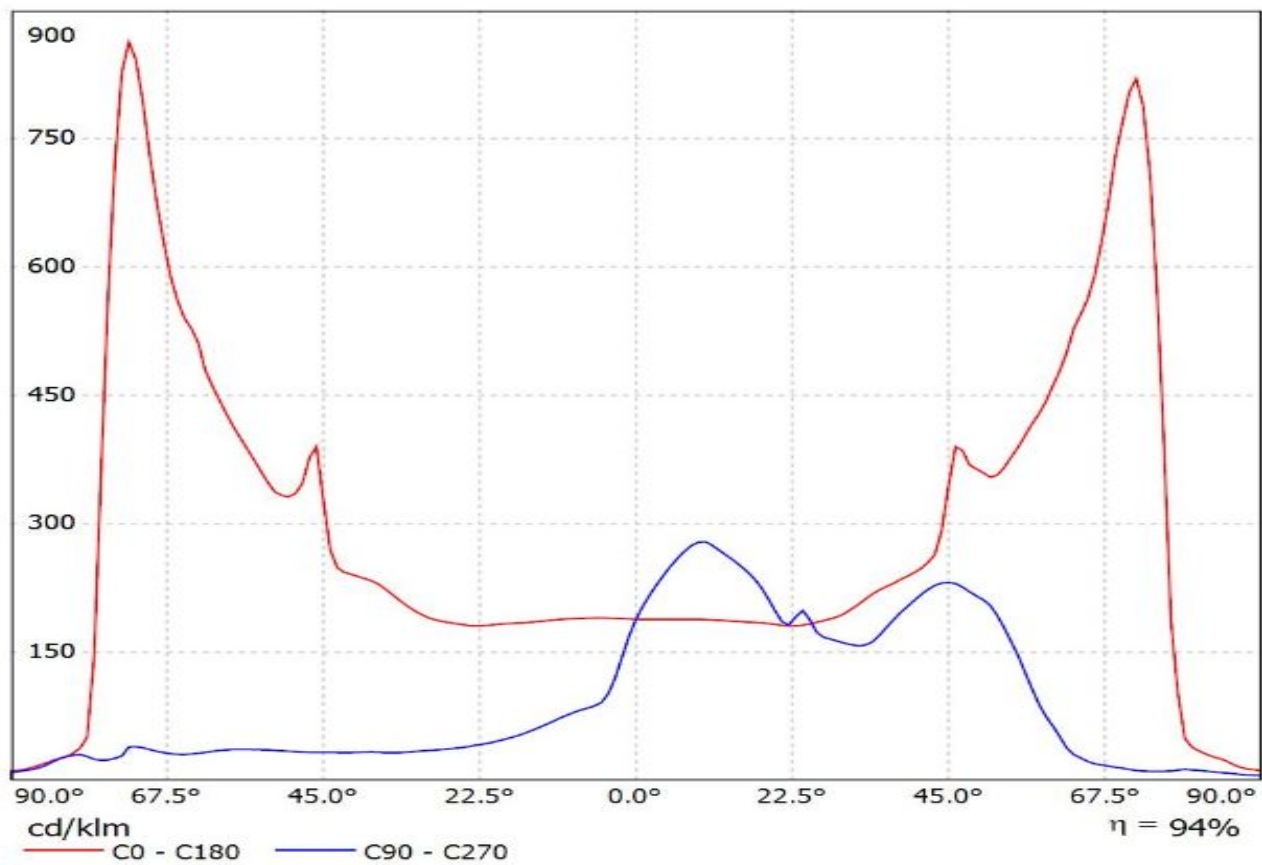

Luminaire: LEDiL Oy C15021_STRADA-2X2-SCL_(NVSW319AE)
Lamps: 1 x Nichia_NVSW319AE_499.093lm@250mA_P=2.79052W_I=0.25A

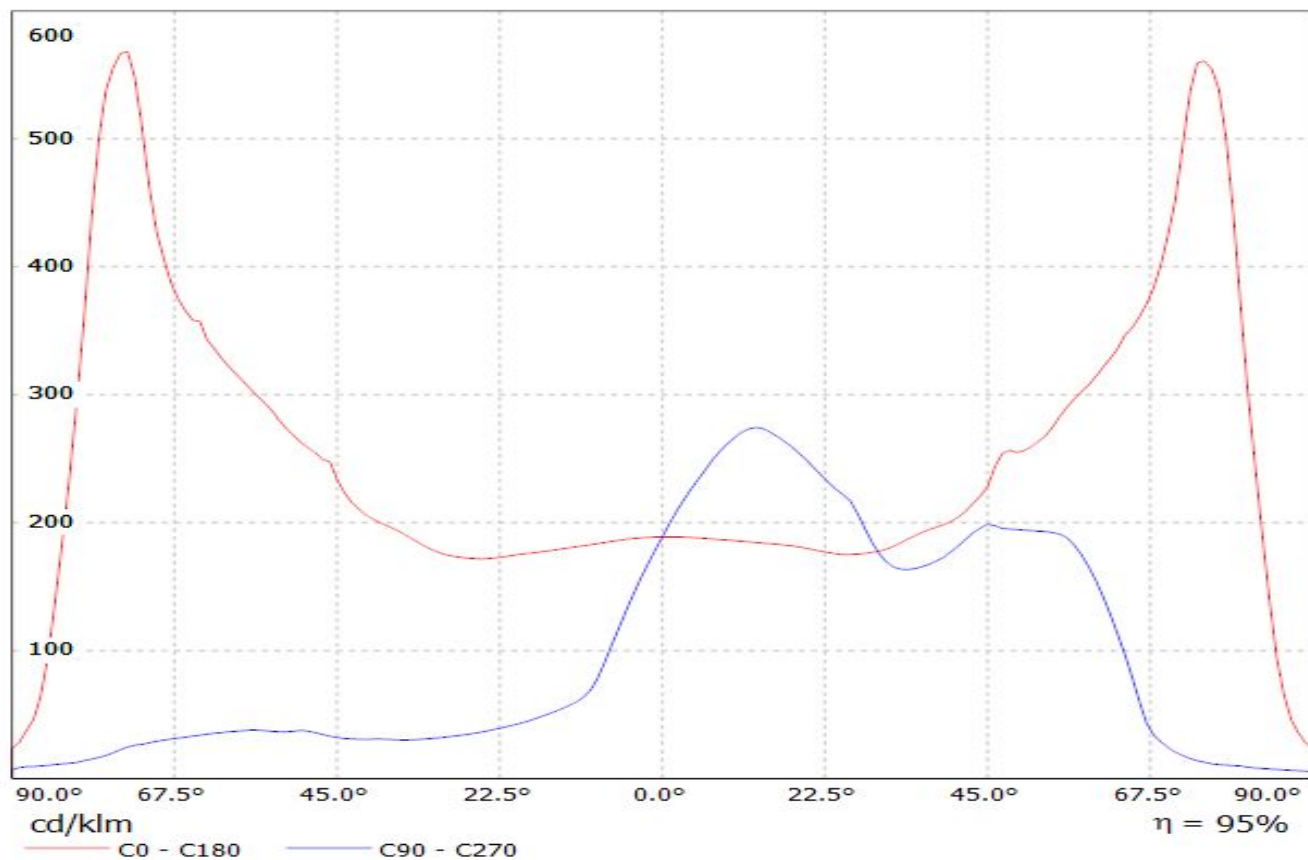

Luminaire: Ledil Oy C15021_STRADA-2X2-SCL_with_glass_SIMULATED
Lamps: 1 x Nichia_NVSL219B-V1(3000K, R8000)

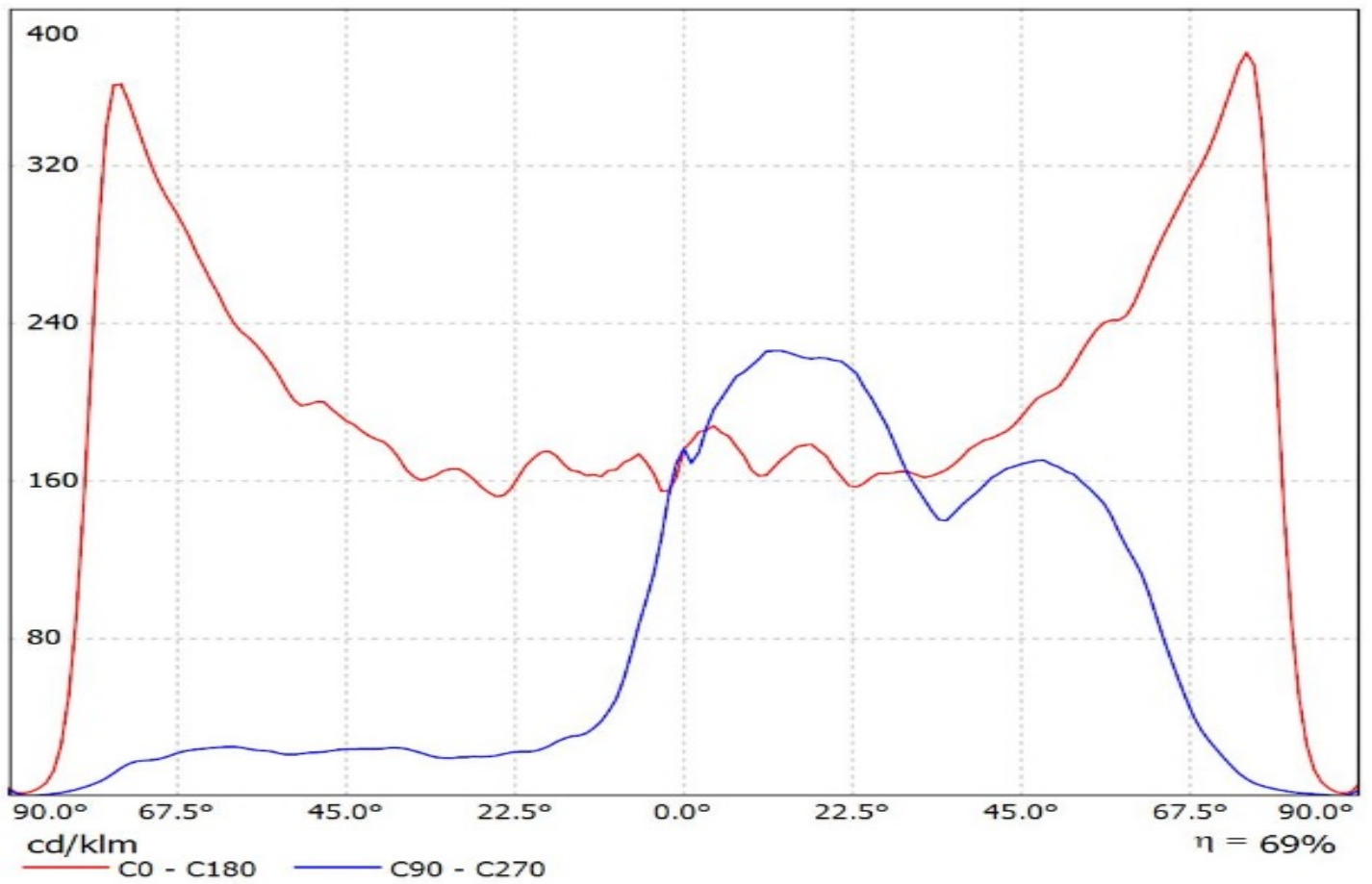

Luminaire: Ledil Oy C15021_STRADA-2X2-SCL_(Duris_S8)_SIMULATED
Lamps: 1 x Osram Duris S8 (GW P9LM21.EM)

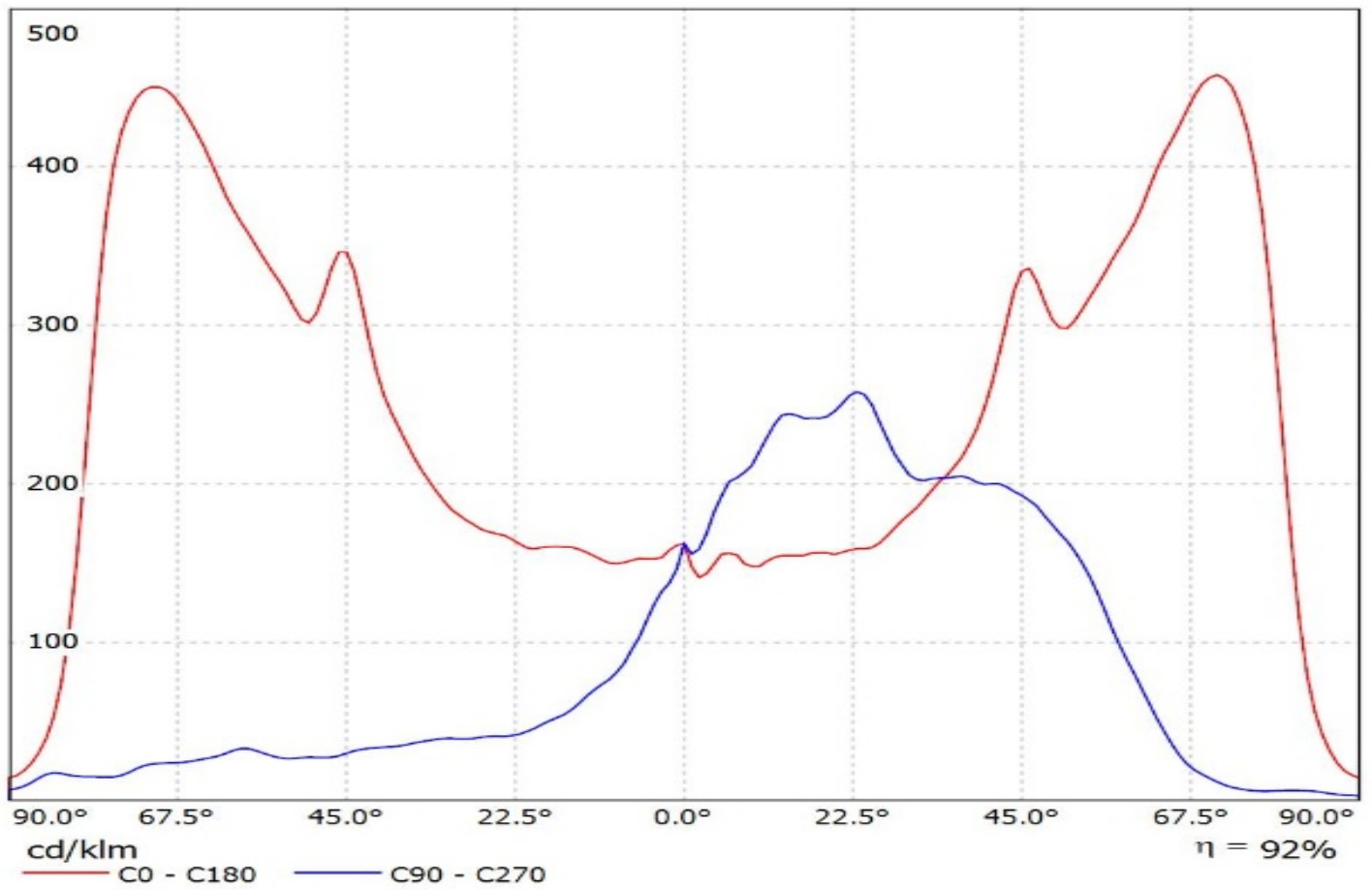

Ledil C15021_STRADA-2X2-SCL_(SQ-PC) / LDC (Linear)

Luminaire: Ledil C15021_STRADA-2X2-SCL_(SQ-PC)
Lamps: 1 x Osram_Oslon_Square-PC_2x2_(GW_CSSRM1.PC)
_421.516lm@250mA_CCT=5201K_P=2.8653W_I=0.25A

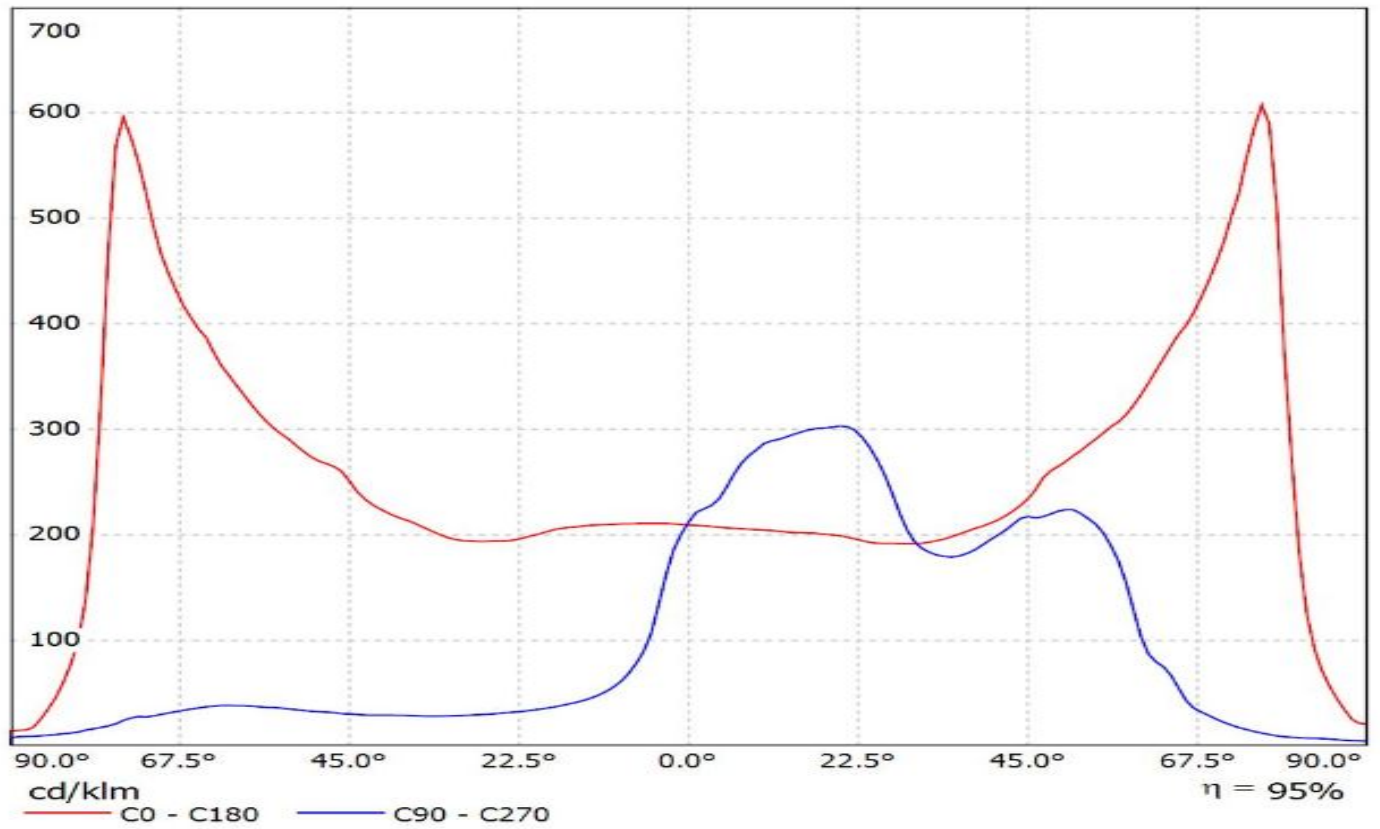

Luminaire: Ledil C15021_STRADA-2X2-SCL (Square_Gen3)

Lamps: 1 x Osram_Square_Gen3 (GW_CSSRM2.PM)_461.082lm@250mA_P=2.79075W_I=0.250A

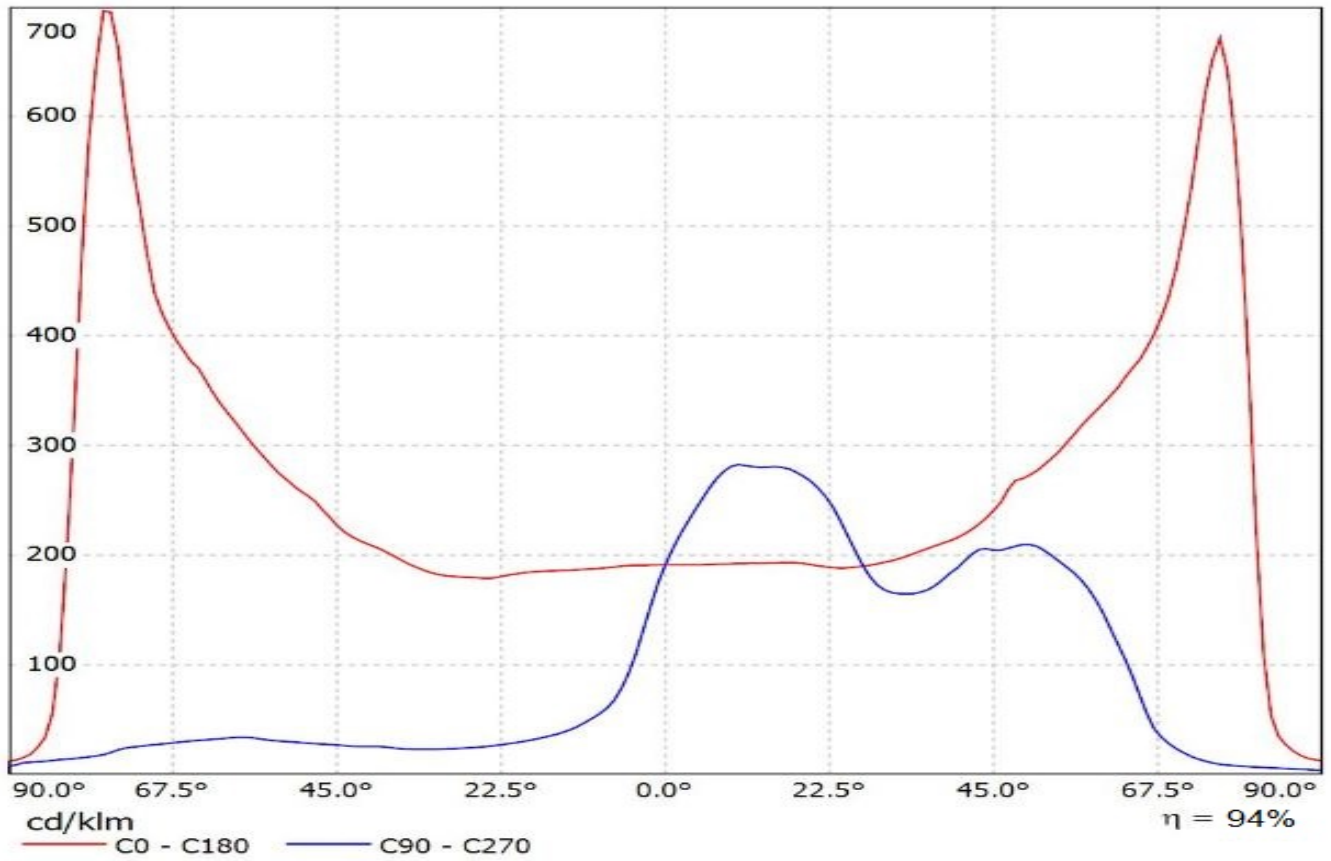

Luminaire: Ledil Oy C15021_STRADA-2X2-SCL_OSRAM_DURIS_P9_SIMULATED
Lamps: 1 x OSRAM DURIS P9

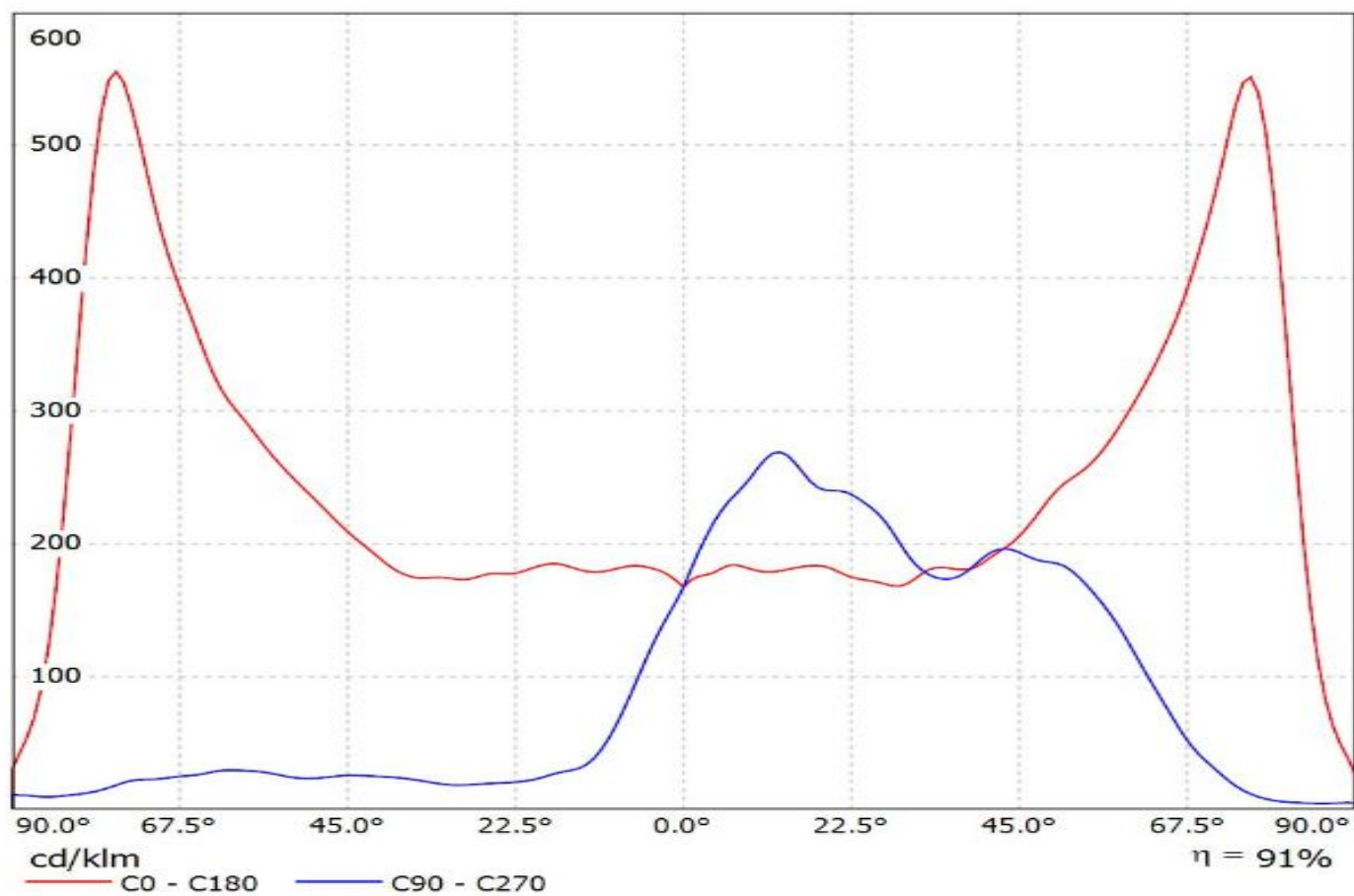

Luminaire: Ledil C15021_STRADA-2X2-SCL_(Fortimo_FastFlex_LED_board_2x8/740_DA_G3)
Lamps: 1 x Fortimo_FastFlex_LED_board_2x8/740_DA_G3_1828.23lm@250mA_P=11.667W_I=0.25A

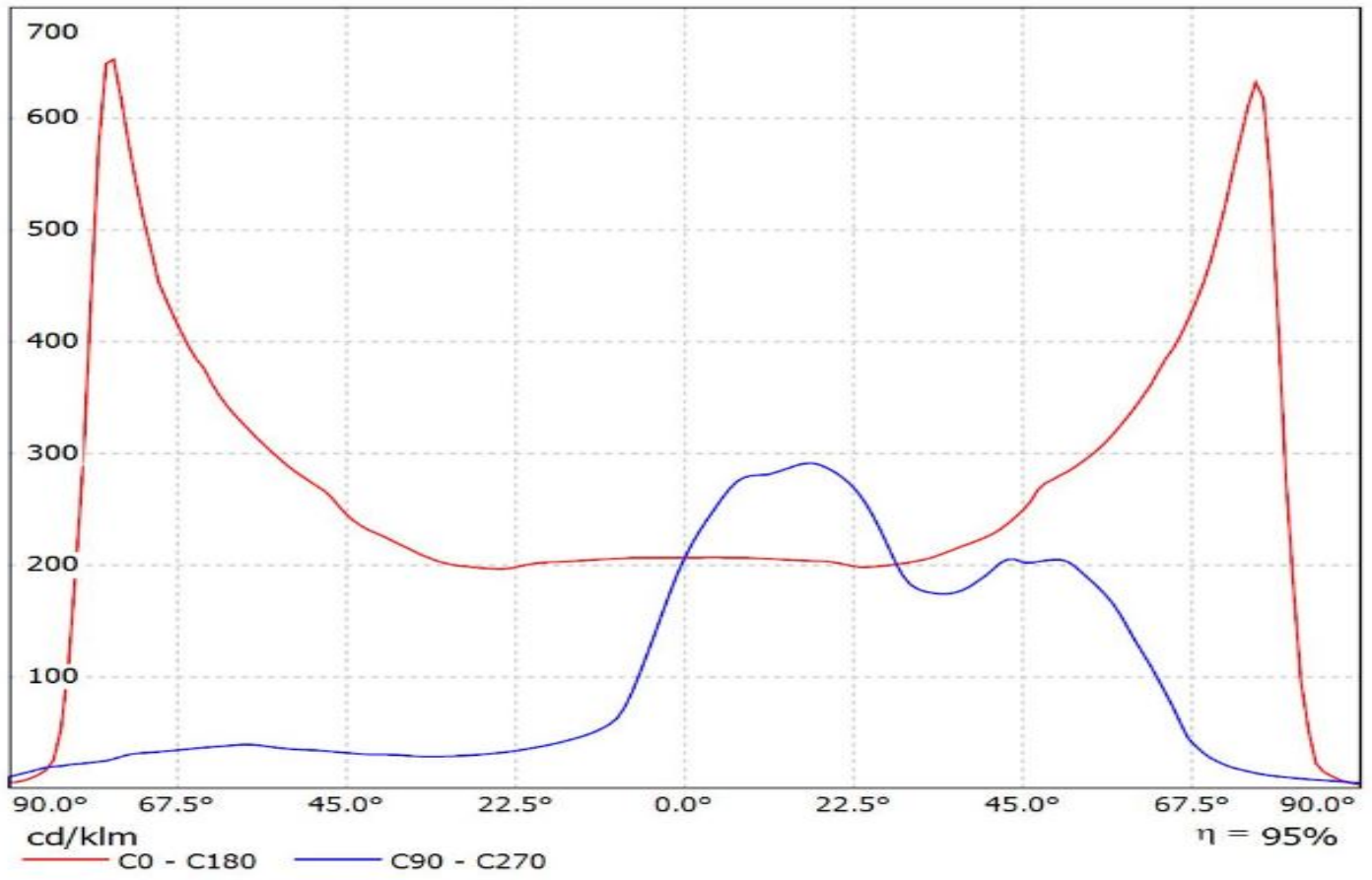

Luminaire: Ledil Oy C15021_STRADA-2X2-SCL_Fortimo FastFlex LED board 2x8 DAX G4_SIMULATED
Lamps: 1 x Fortimo FastFlex LED board 2x8 DAX G4

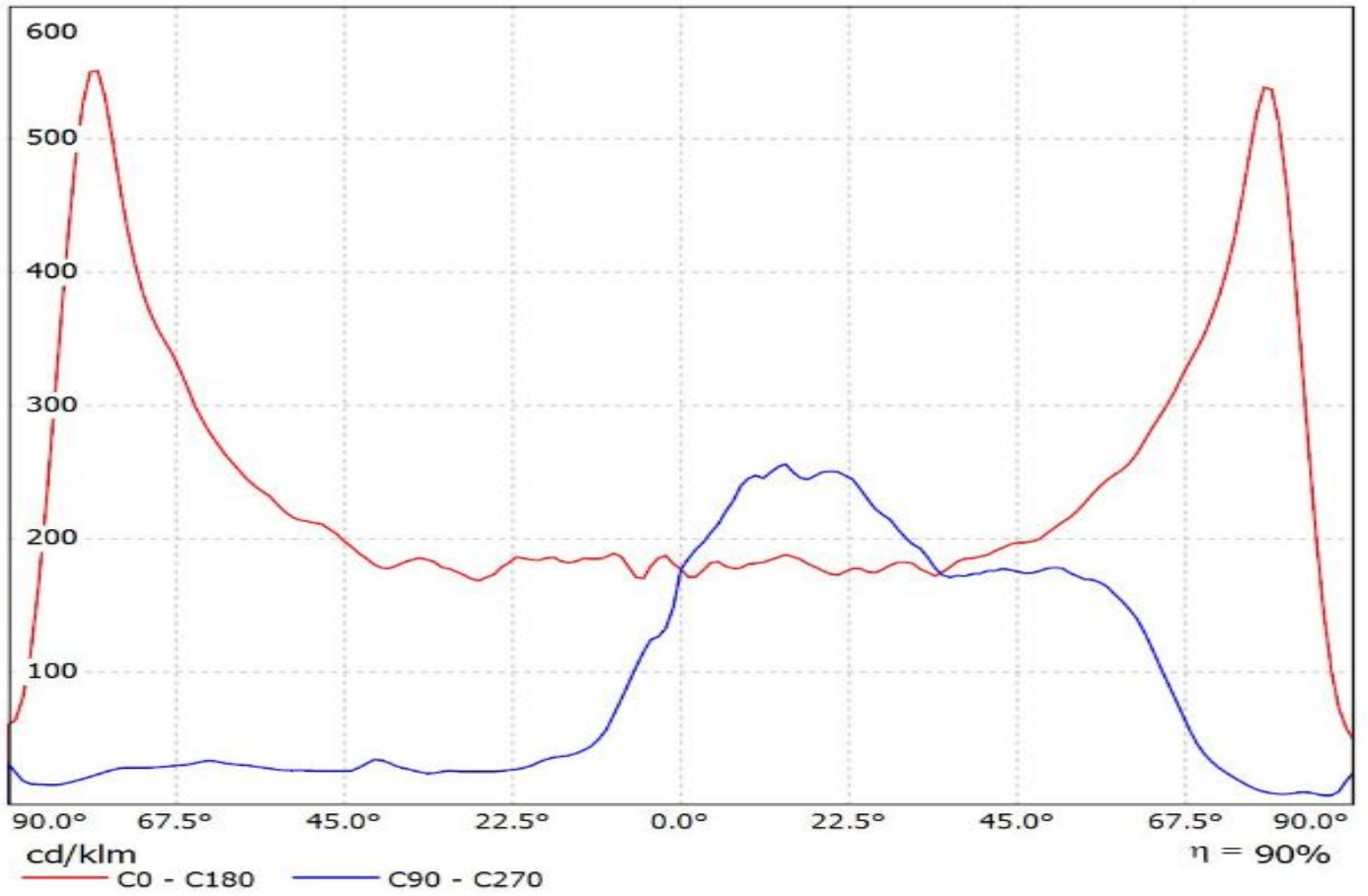

Luminaire: Ledil C15021_STRADA-2X2-SCL (LH351B)

Lamps: 1 x Samsung_LH351B_2x2_444.178lm@250mA_P=2.8535W_I=0.25A

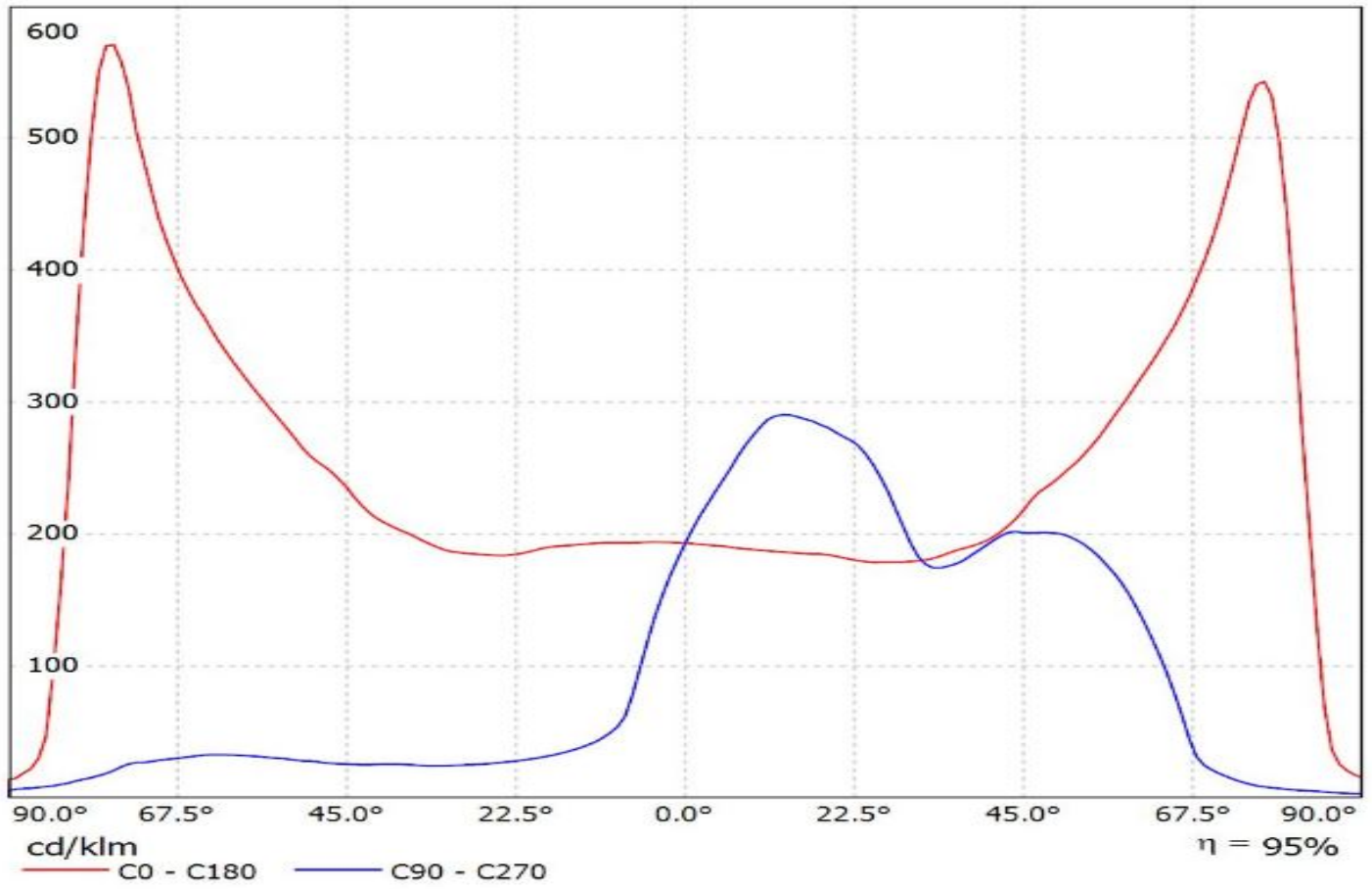

Luminaire: LEDiL Oy C15021_STRADA-2X2-SCL_(LH351D)
Lamps: 1 x Samsung_LH351D_524.264lm@250mA_P=2.7523W_I=0.250A

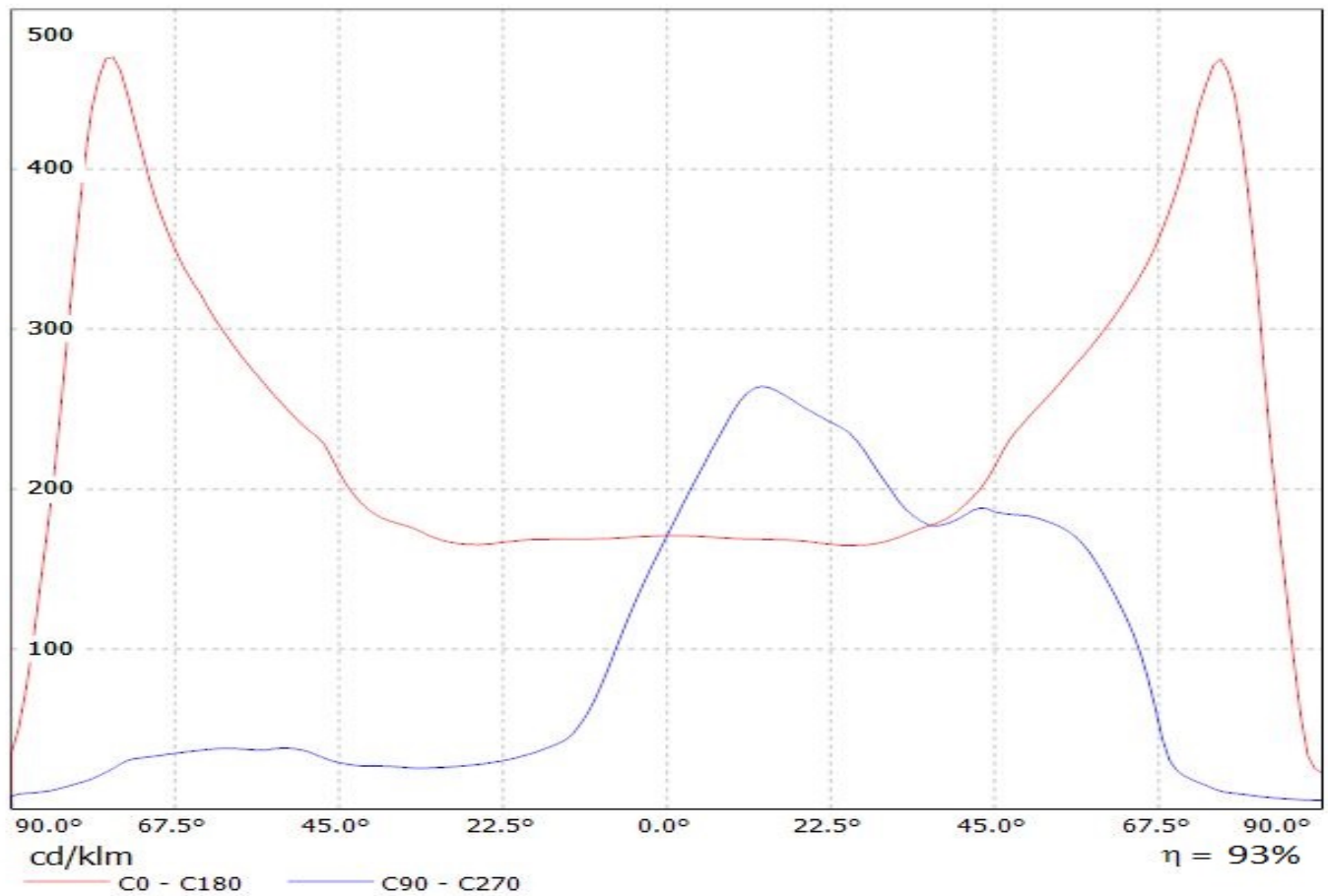

Luminaire: Ledil C15021_STRADA-2X2-SCL_(LH351C)

Lamps: 1 x Samsung_LH351C_518.223lm@250mA_P=2.85225W_I=0.25A

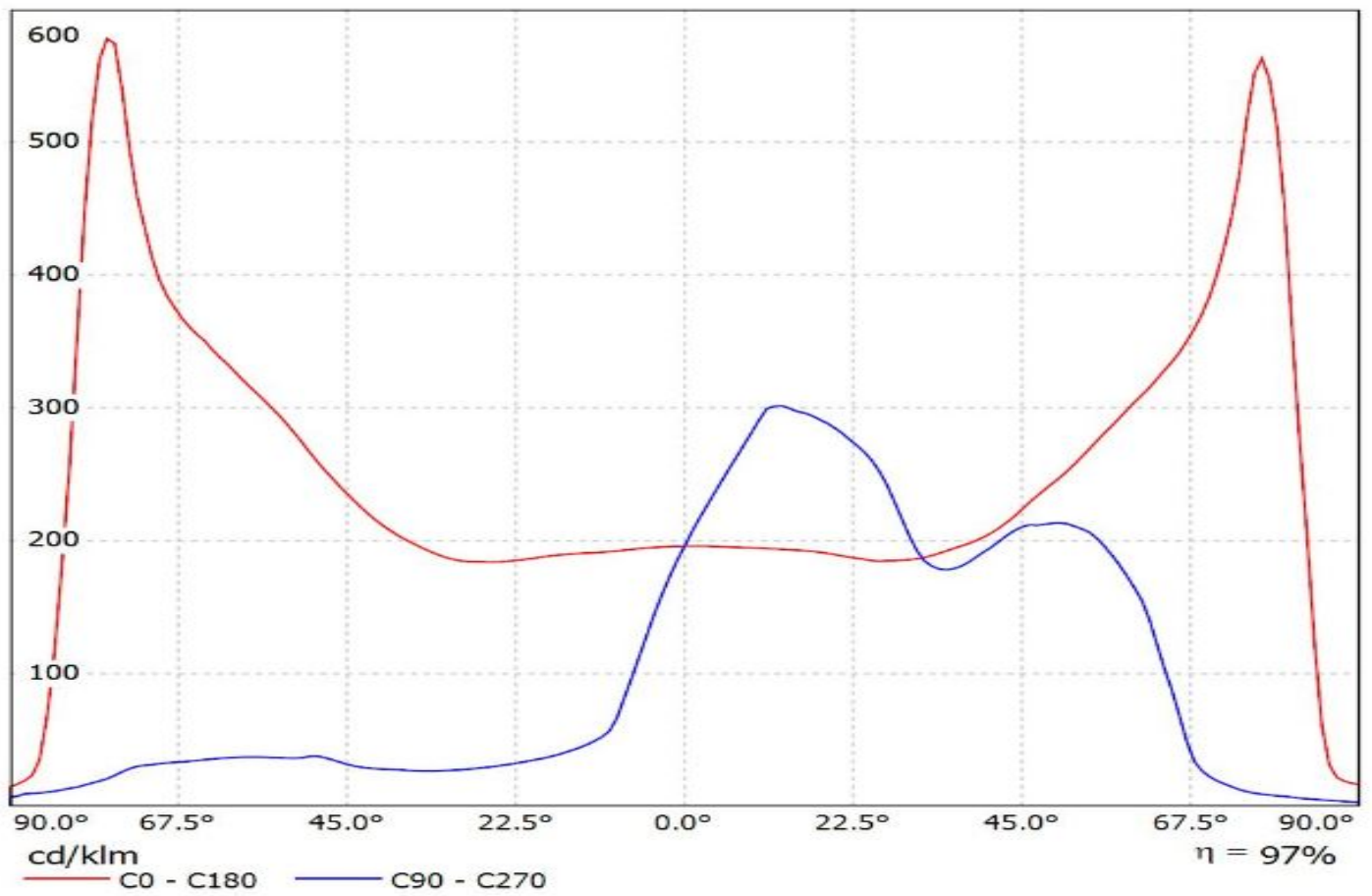

Luminaire: Ledil C15021_STRADA-2X2-SCL_(LH508A)

Lamps: 1 x Samsung_LH508A_2x2_2060.04lm@160mA_CCT=5000K_CRI=80_P=15.5405W_I=0.16A

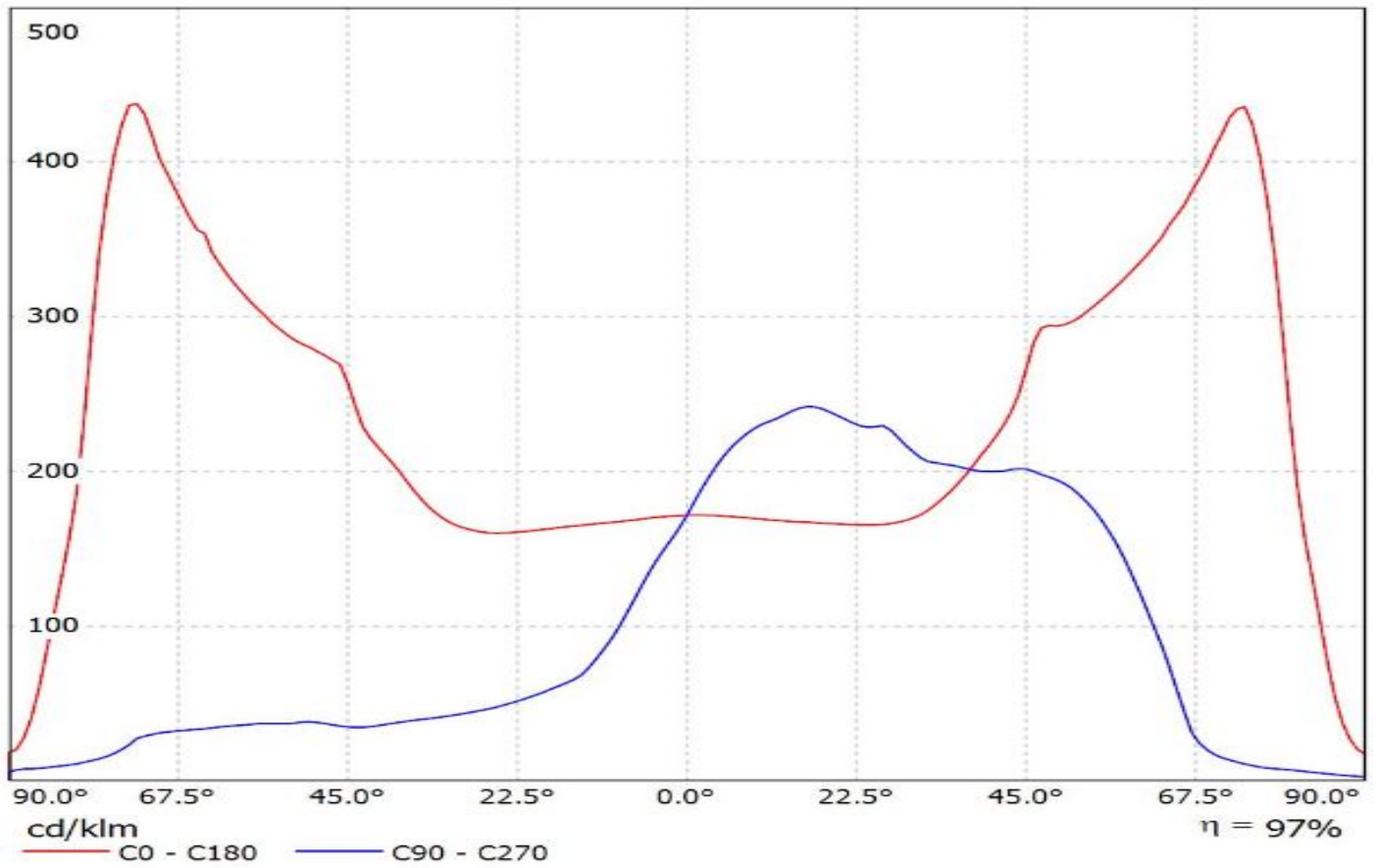

Luminaire: Ledil Oy C15021_STRADA-2X2-SCL_(LH181B)_SIMULATED
Lamps: 1 x Samsung LH181B

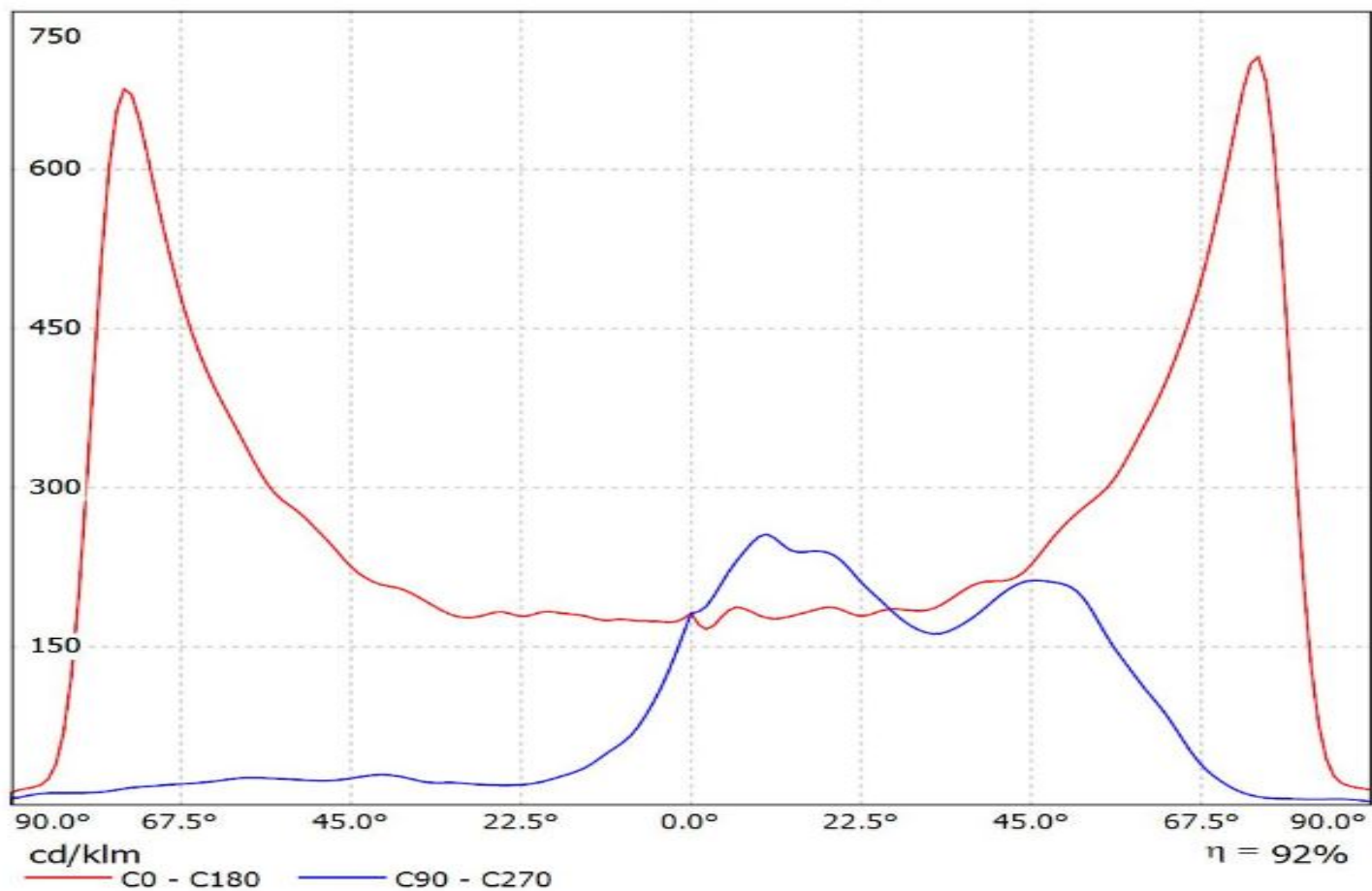

Luminaire: SIMULATED_C15021_STRADA-2X2-SCL_Seoul_Z5M2
Lamps: 1 x

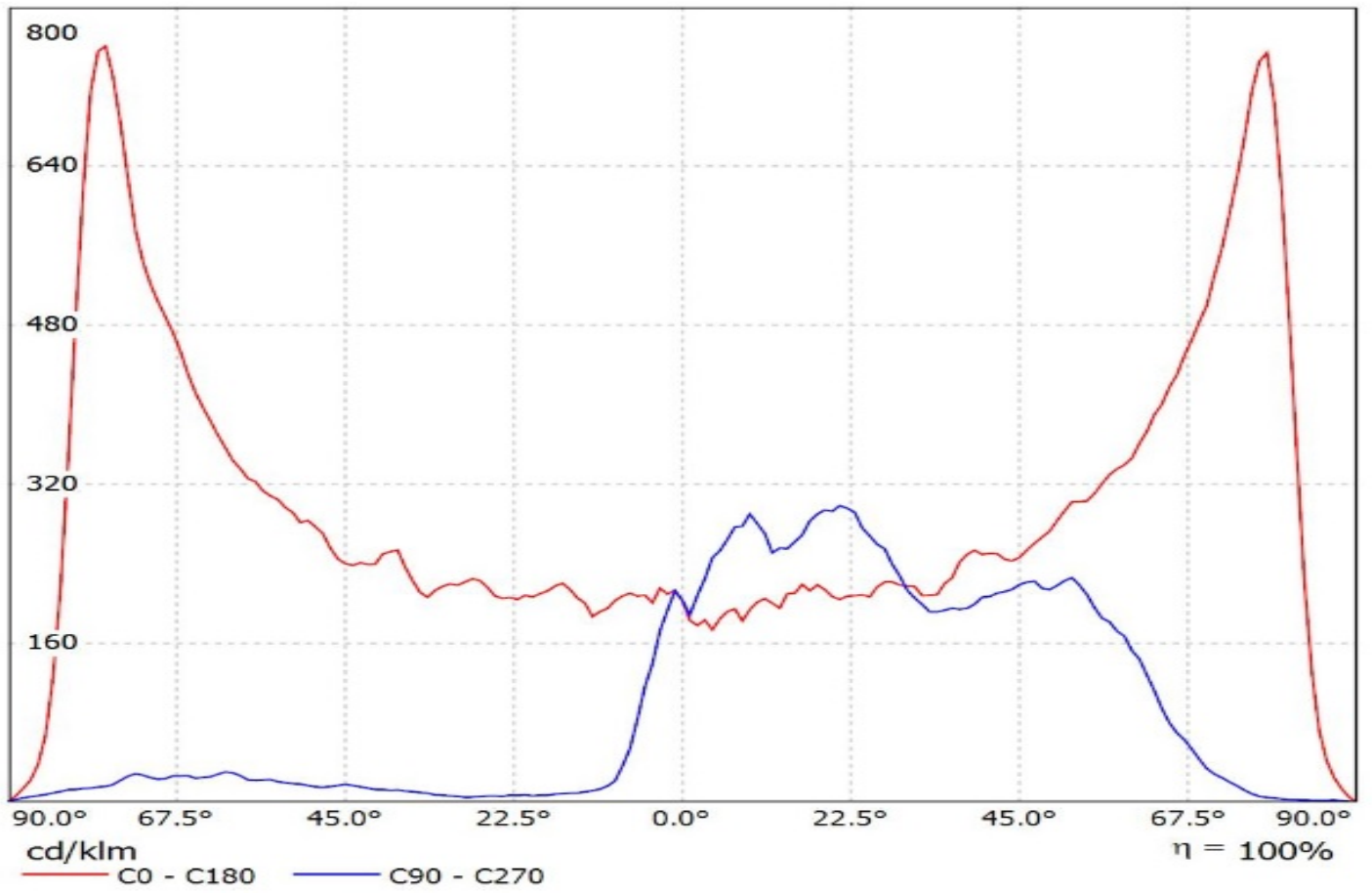

Luminaire: Ledil C15021_STRADA-2X2-SCL_(Z8Y22plus)

Lamps: 1 x Seoul_Z8Y22plus_(W6E2G)_513.996lm@250mA_P=2.754W_I=0.250A

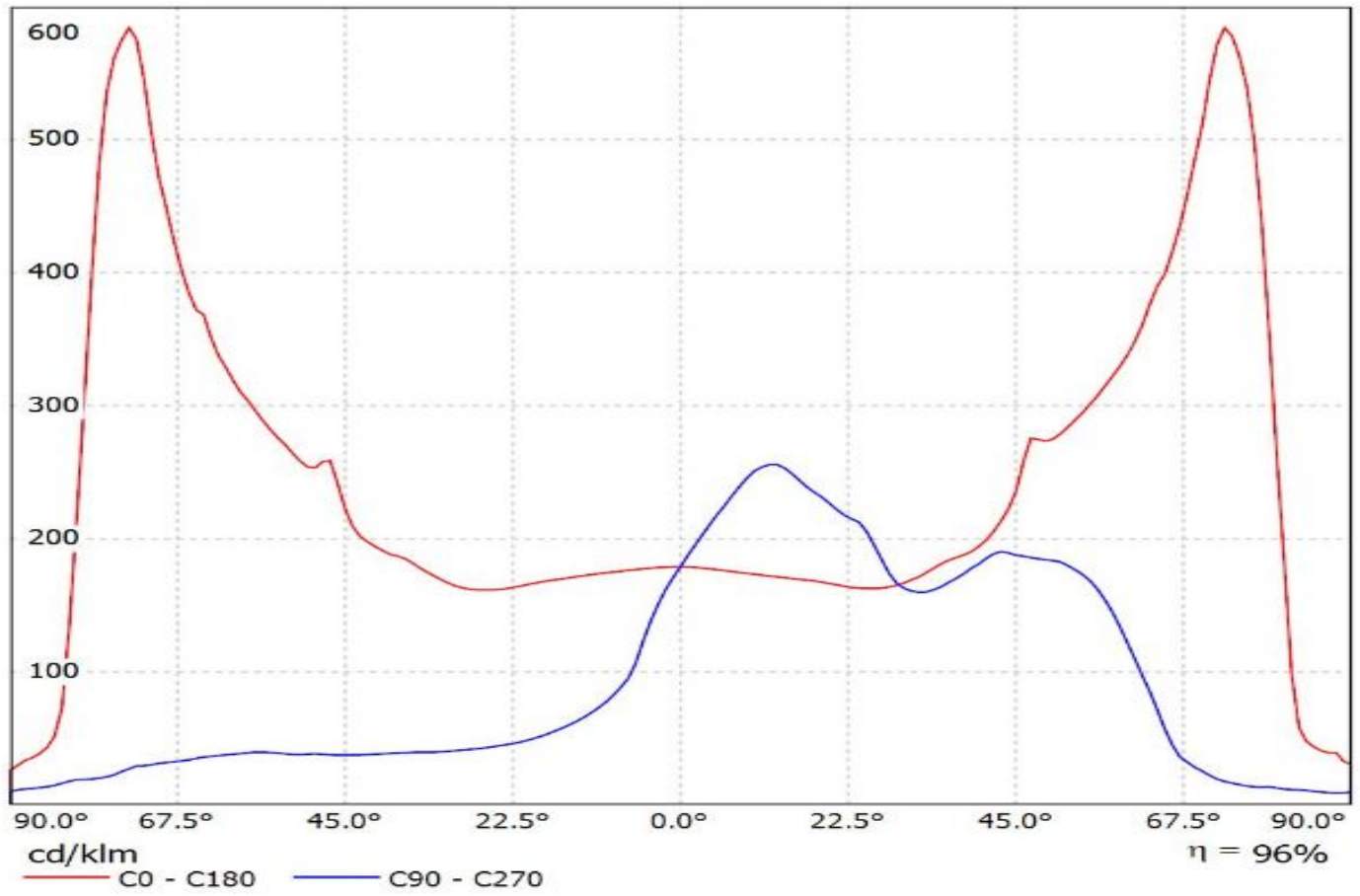

Luminaire: LEDiL Oy C15021_STRADA-2X2-SCL_(Z8Y22)

Lamps: 1 x Seoul_Wicop_Z8Y22_497.373lm@250mA_P=2.80076W_U=11.211V

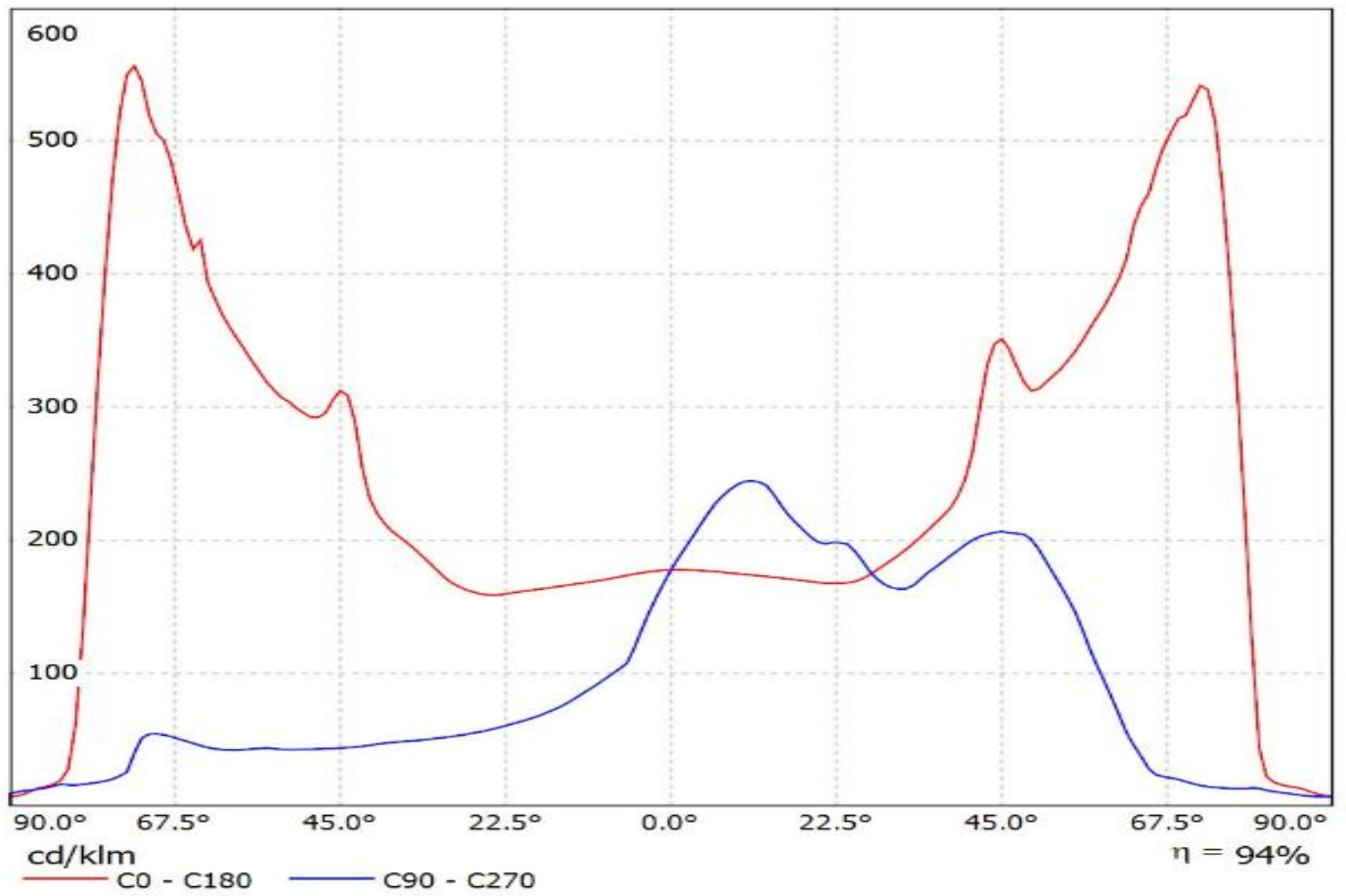

Luminaire: SIMULATED_C15021_STRADA-2X2-SCL_Toshiba_TL1L4
Lamps: 1 x

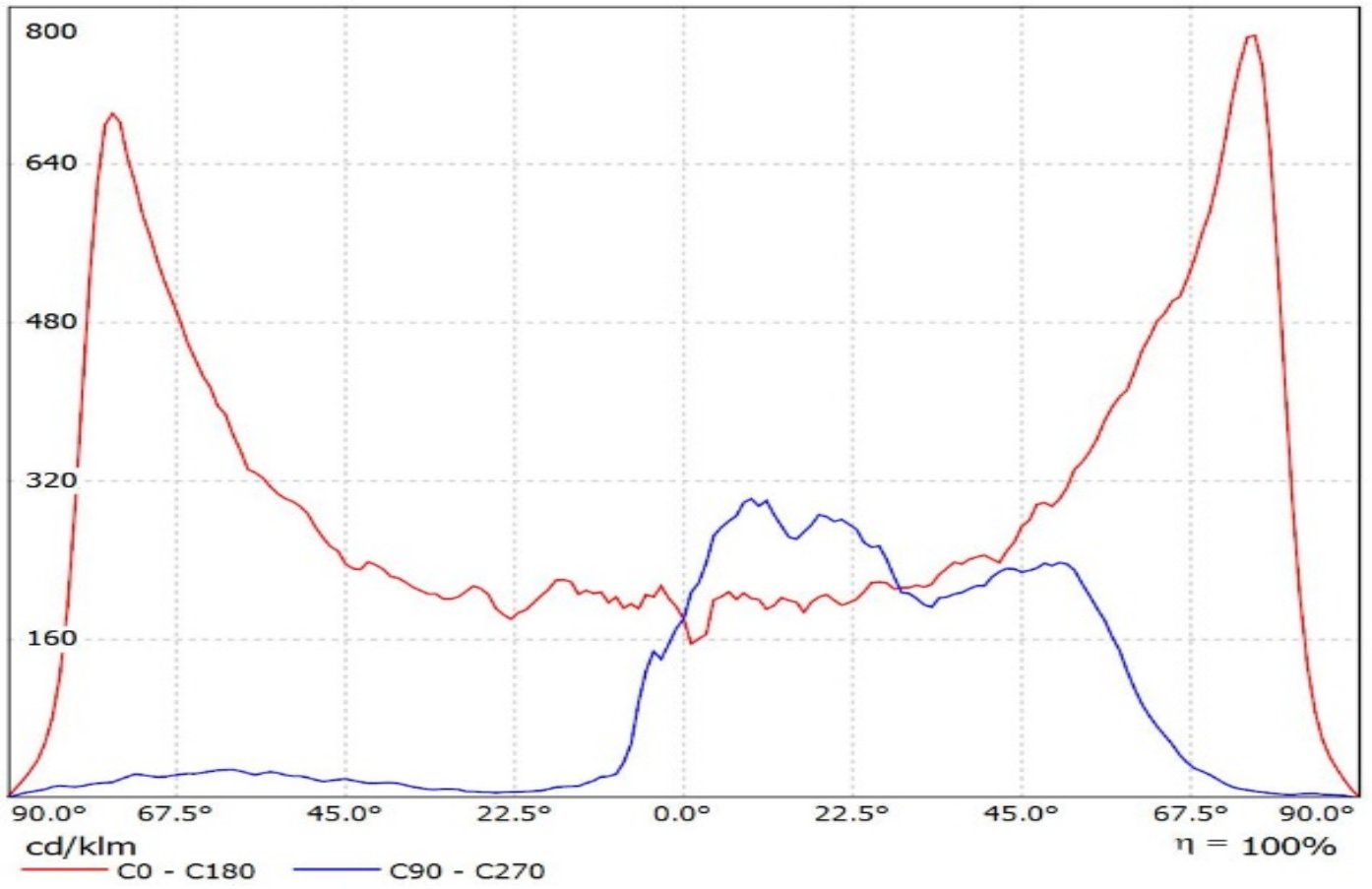

Luminaire: LEDiL Oy C15021_STRADA-2X2-SCL_(Tridonic_Module_RLE_G1)
Lamps: 1 x Tridonic_Module_RLE_G1_4594.42lm@700mA_P=32.1515W_I=0.700A

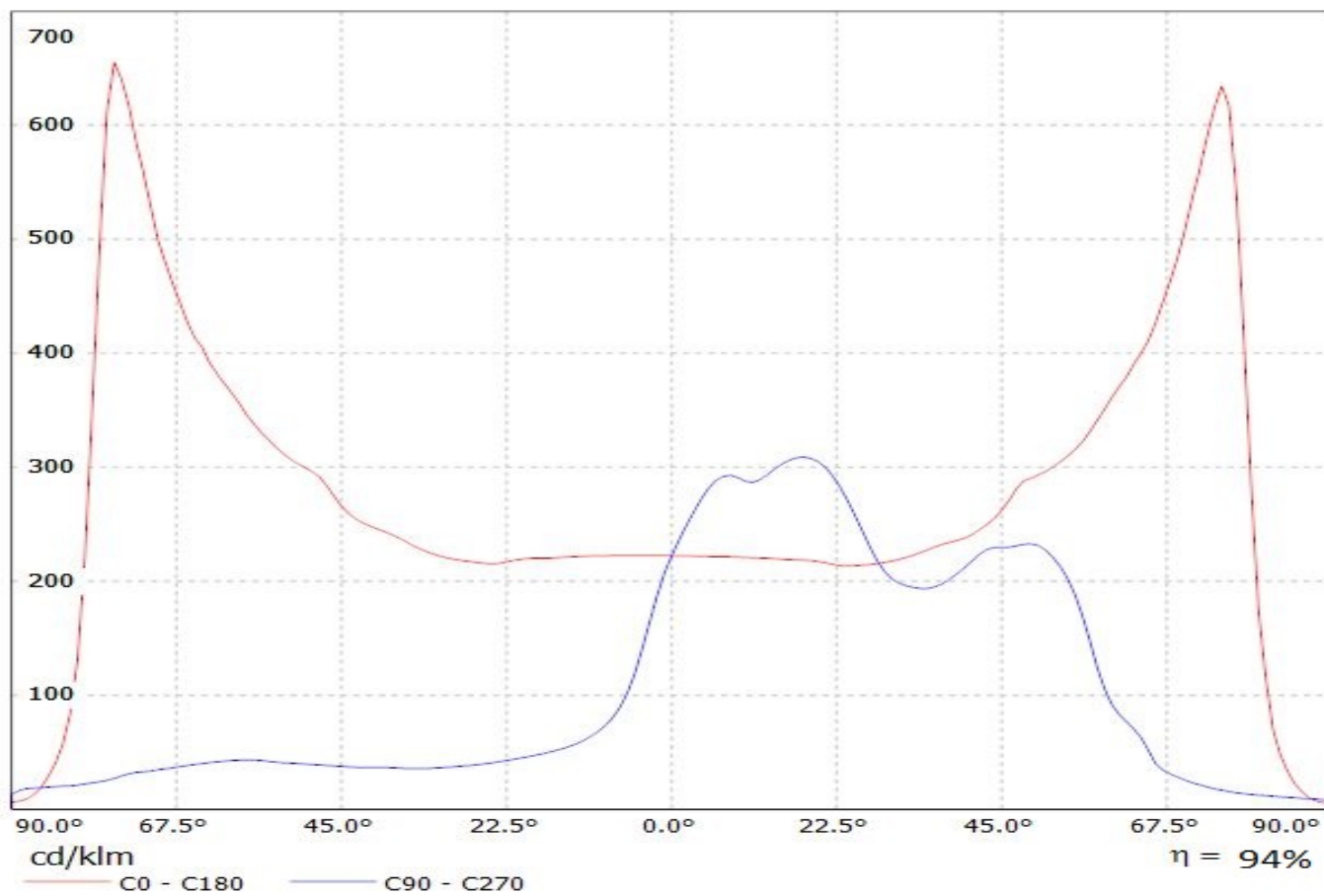

Luminaire: LEDiL Oy C15021_STRADA-2X2-SCL_(Tridonic_Module_RLE_G1)
Lamps: 1 x Tridonic_Module_RLE_G1_4594.42lm@700mA_P=32.1515W_I=0.700A

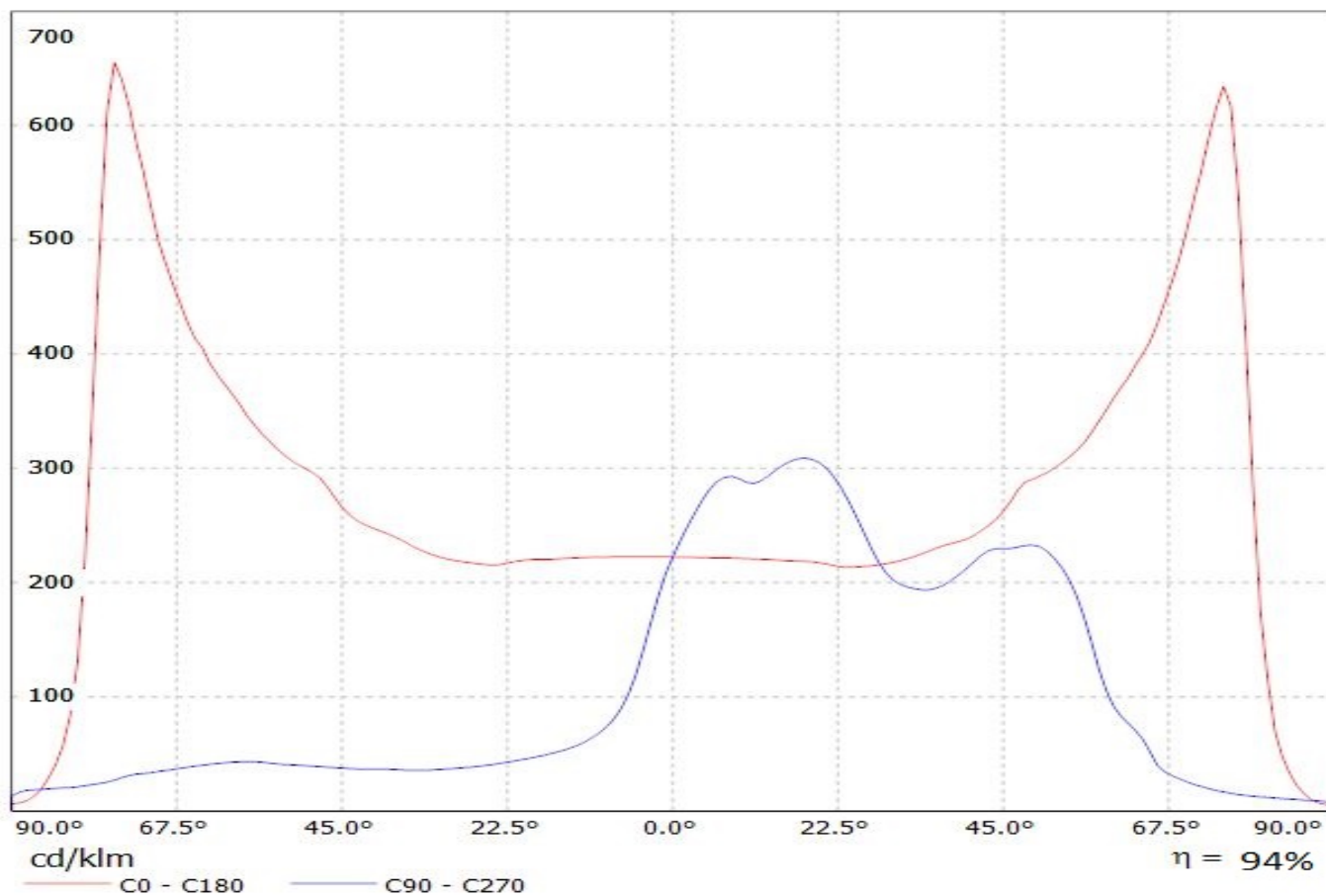

Luminaire: LEDiL Oy C15021_STRADA-2X2-SCL_(Tridonic_Module_RLE_G1)
Lamps: 1 x Tridonic_Module_RLE_G1_2288lm@700mA_P=16W_I=0.700A

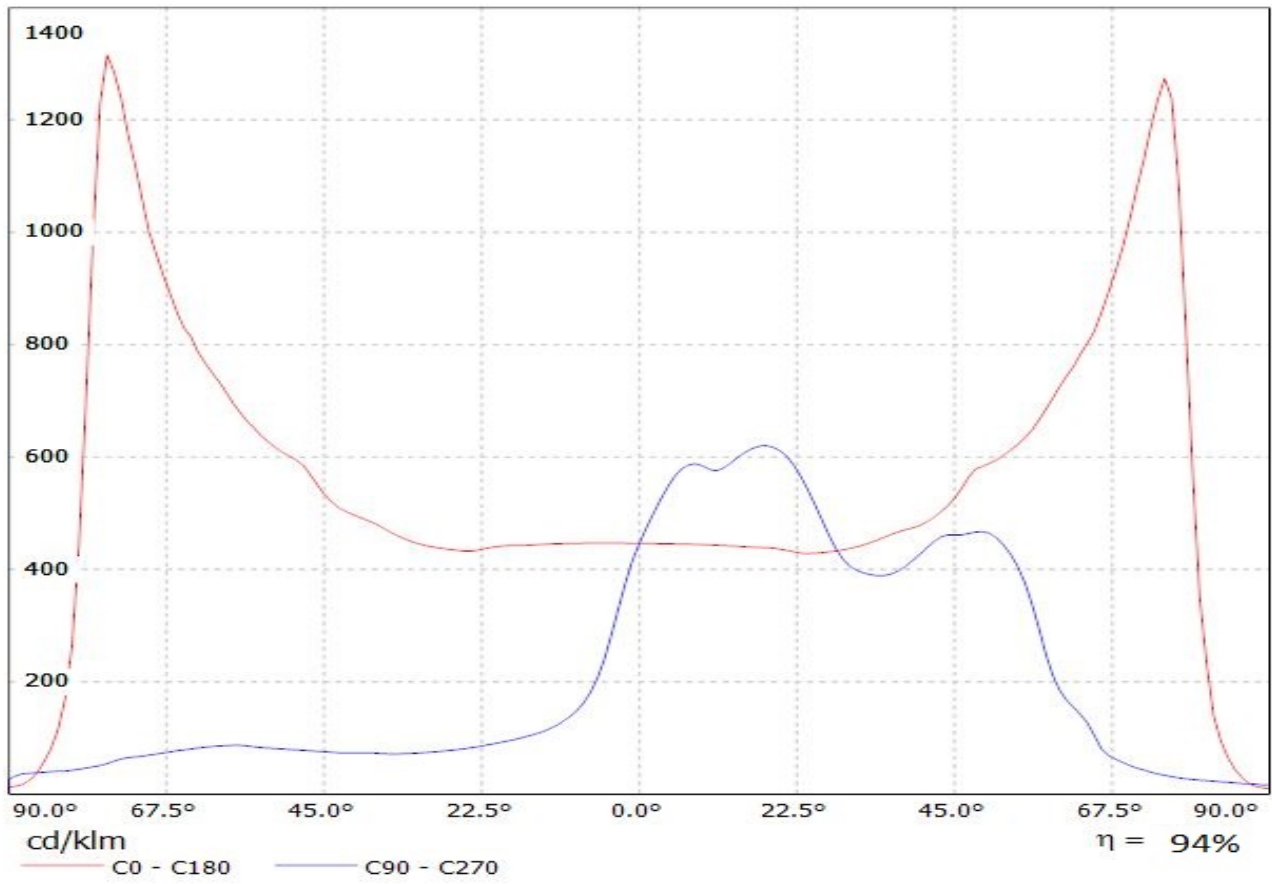

Luminaire: LEDiL Oy C15021_STRADA-2X2-SCL_(Tridonic_Module_RLE_G1)
Lamps: 1 x Tridonic_Module_RLE_G1_2288lm@700mA_P=16W_I=0.700A

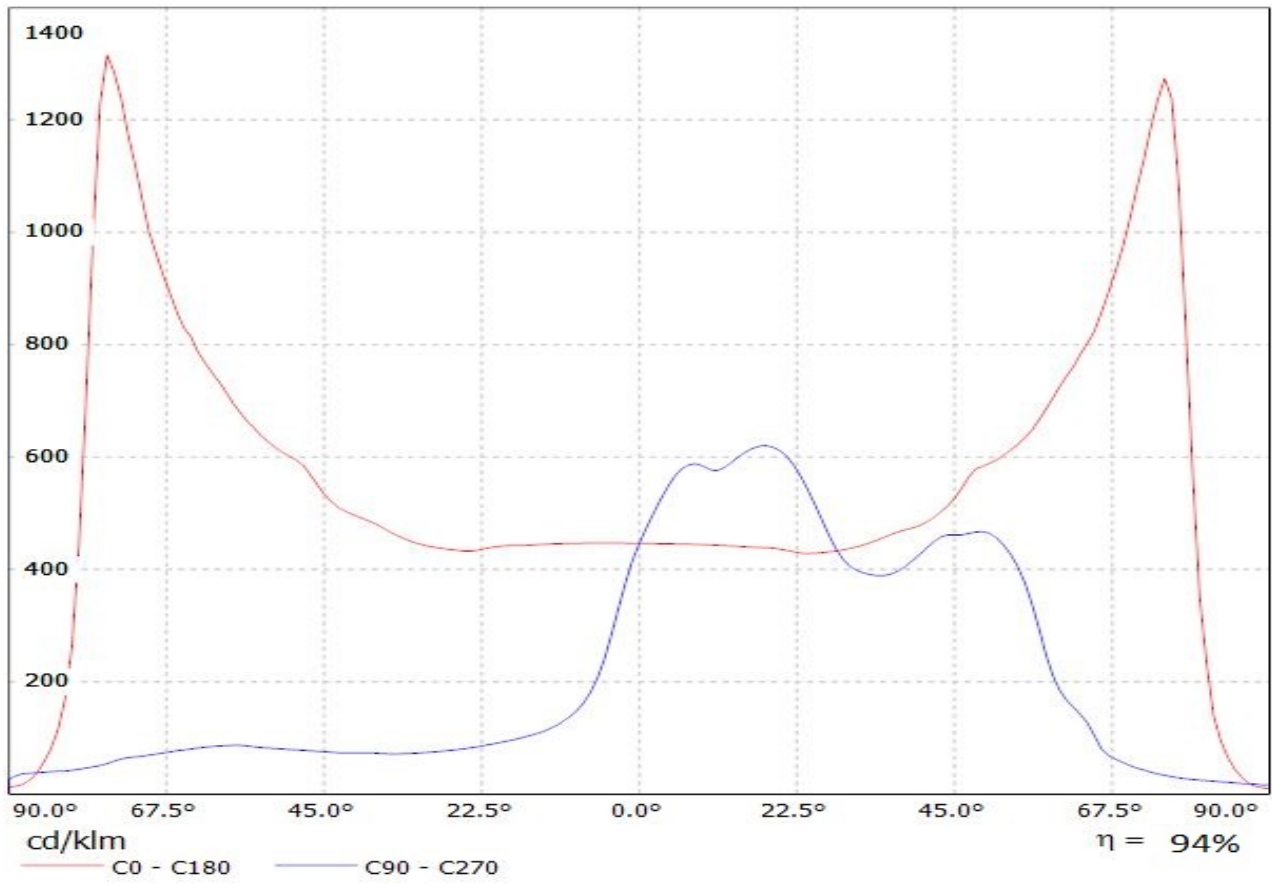

Luminaire: LEDiL Oy C15021_STRADA-2X2-SCL_(Bridgelux_5050_Gen2)

Lamps: 1 x Bridgelux_5050_Gen2_2x2_(BXEP-57C-435-09B)_1447.45lm@250mA_CCT=5700K_P=8.29761W_I=0.25A

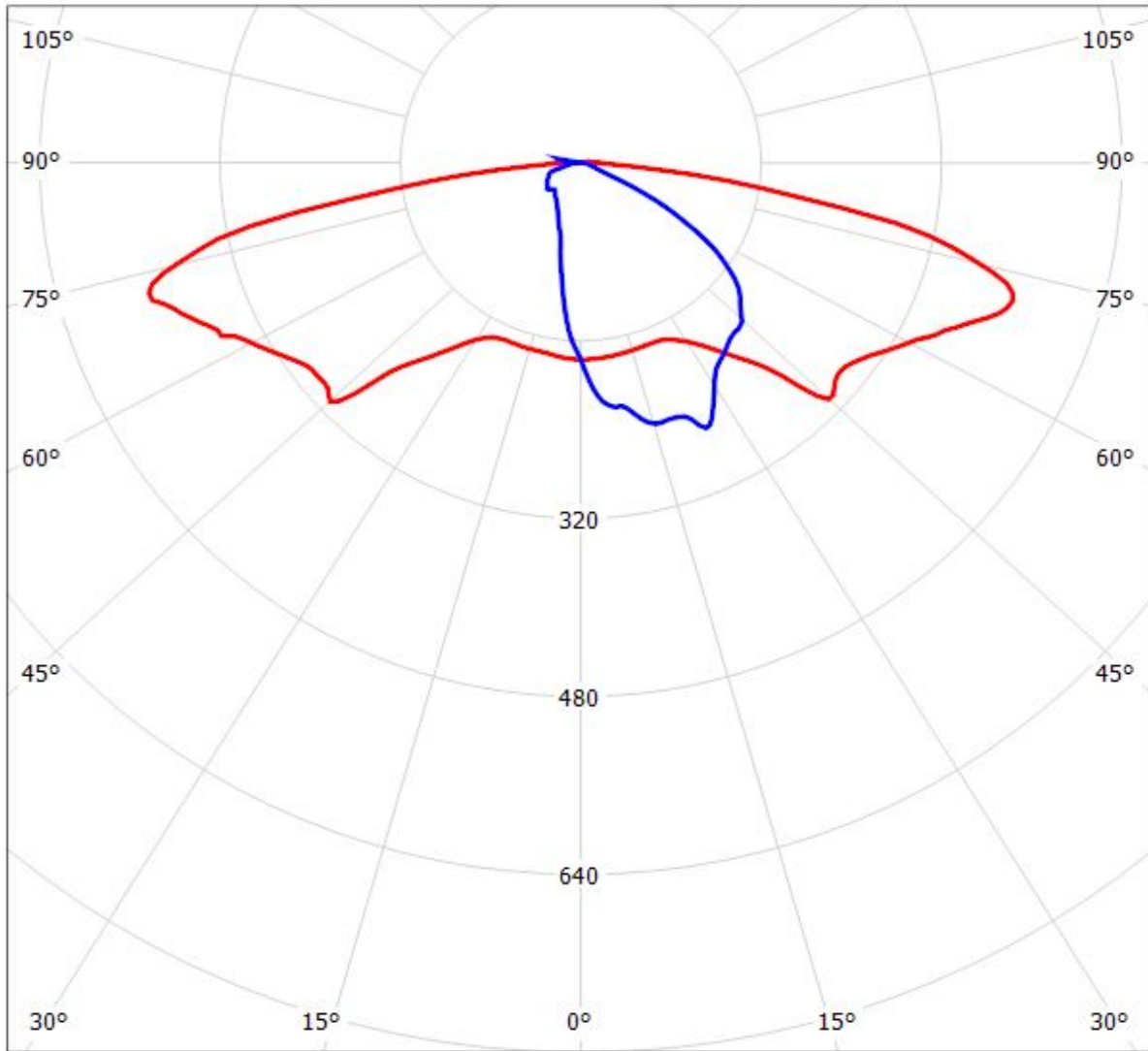

cd/klm

— C0 - C180 — C90 - C270

$\eta = 97\%$

Luminaire: Ledil C15021_STRADA-2X2-SCL_(XTP_2x4_740_LS_G5)

Lamps: 1 x QUICK_FLUX_XTP_2x4_740_LS_G5_967.825lm@0.250mA_P=5.71896W_I=250A

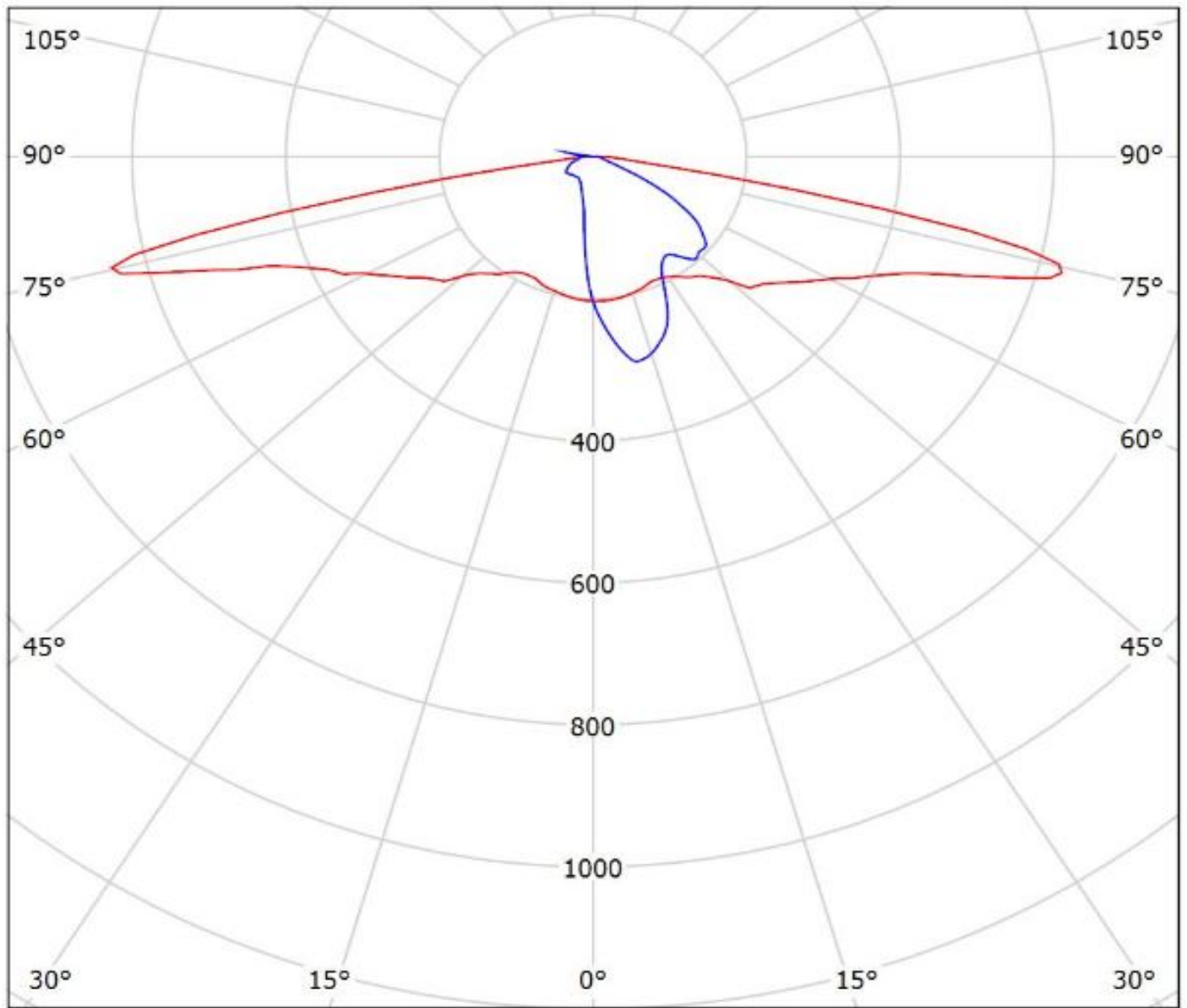

cd/klm

— C0 - C180 — C90 - C270

$\eta = 95\%$

Luminaire: Ledil C15021_STRADA-2X2-SCL_(QUICK_FLUX_XTP_2x6_740_LS_G5)

Lamps: 1 x QUICK_FLUX_XTP_2x6_740_LS_G5_1450.62lm@0.250mA_P=8.59856W_I=250A

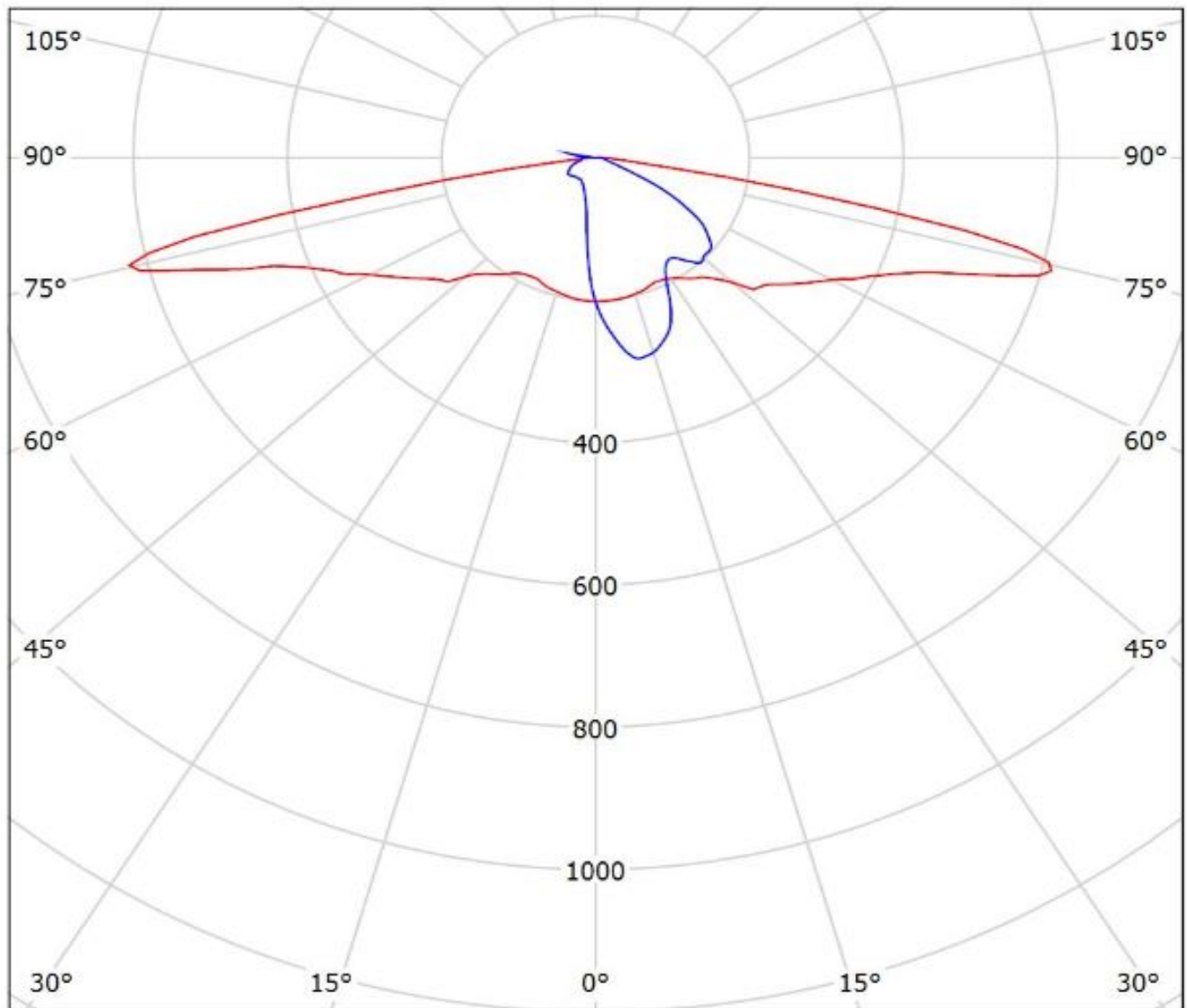

cd/klm

— C0 - C180 — C90 - C270

$\eta = 95\%$

Luminaire: Ledil C15021_STRADA-2X2-SCL_(QUICK_FLUX_XTP_2x8_740_LS_G5)

Lamps: 1 x QUICK_FLUX_XTP_2x8_740_LS_G5_1923.68lm@250mA_P=11.4189W_I=0.25A

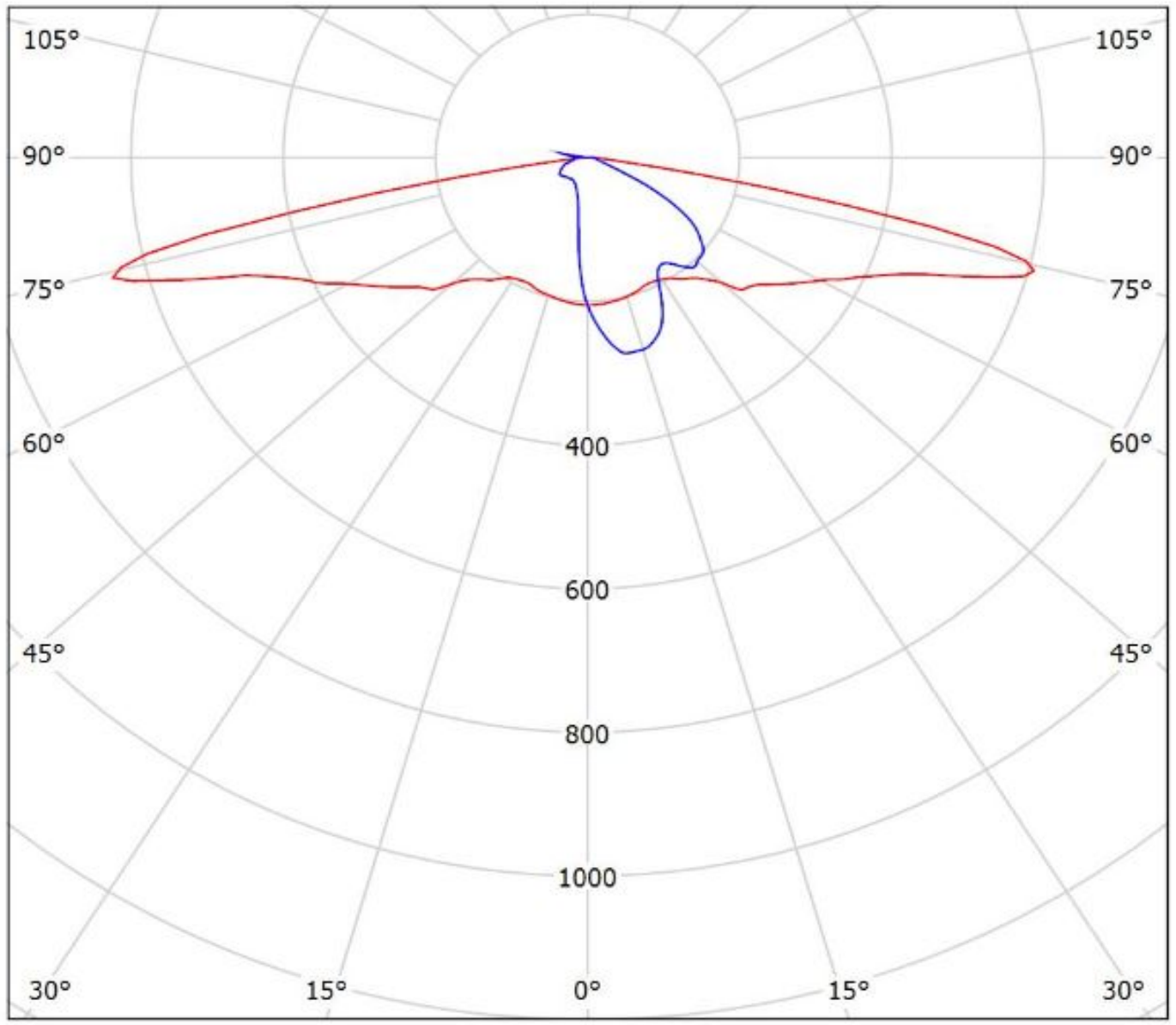

cd/klm

— C0 - C180

— C90 - C270

$\eta = 96\%$

Luminaire: SIMULATED_C15021_STRADA-2X2-SCL_Cree_XB-H
Lamps: 1 x

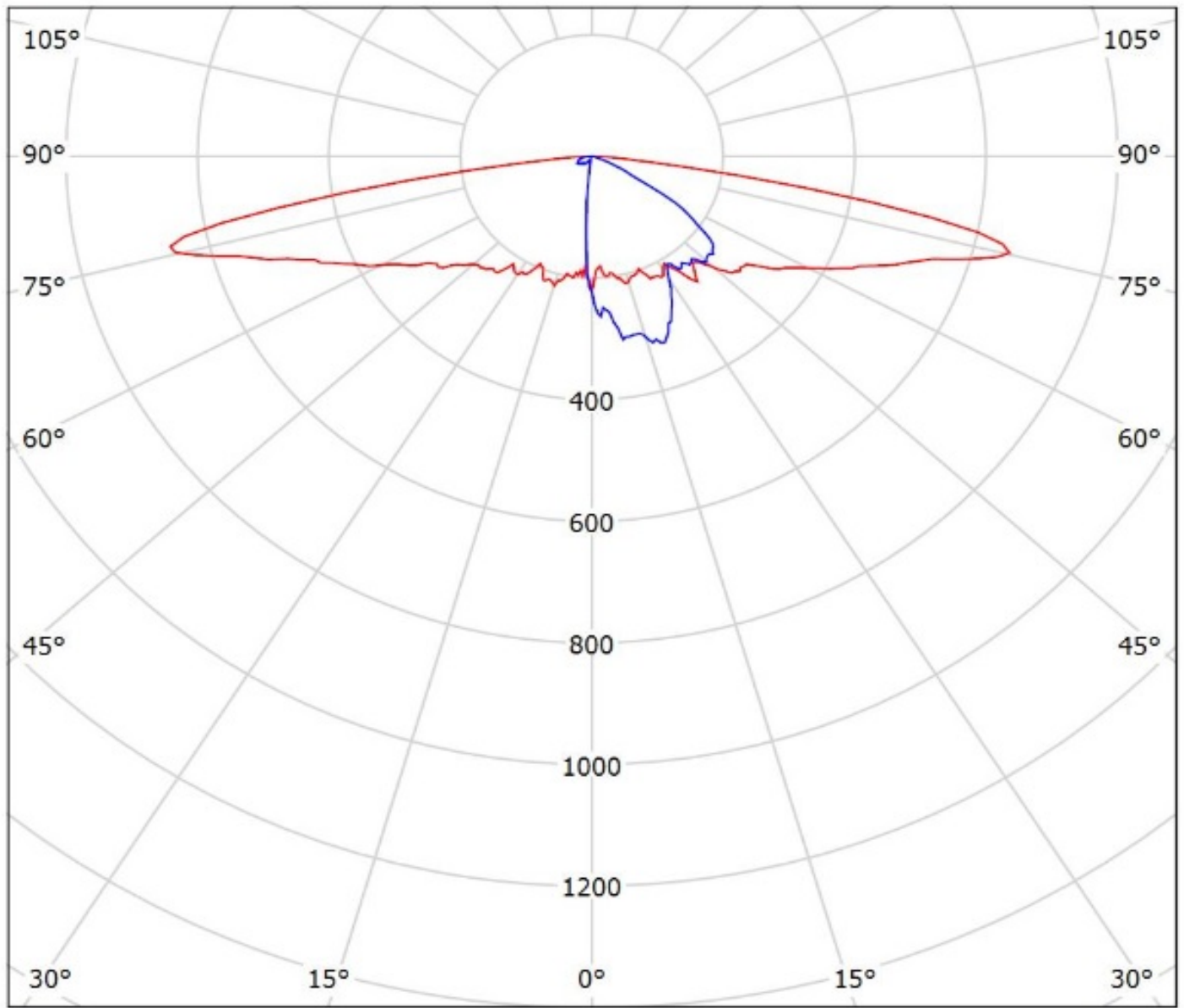

cd/klm

— C0 - C180 — C90 - C270

$\eta = 100\%$

Luminaire: SIMULATED_C15021_STRADA-2X2-SCL_Cree_XHP35

Lamps: 1 x

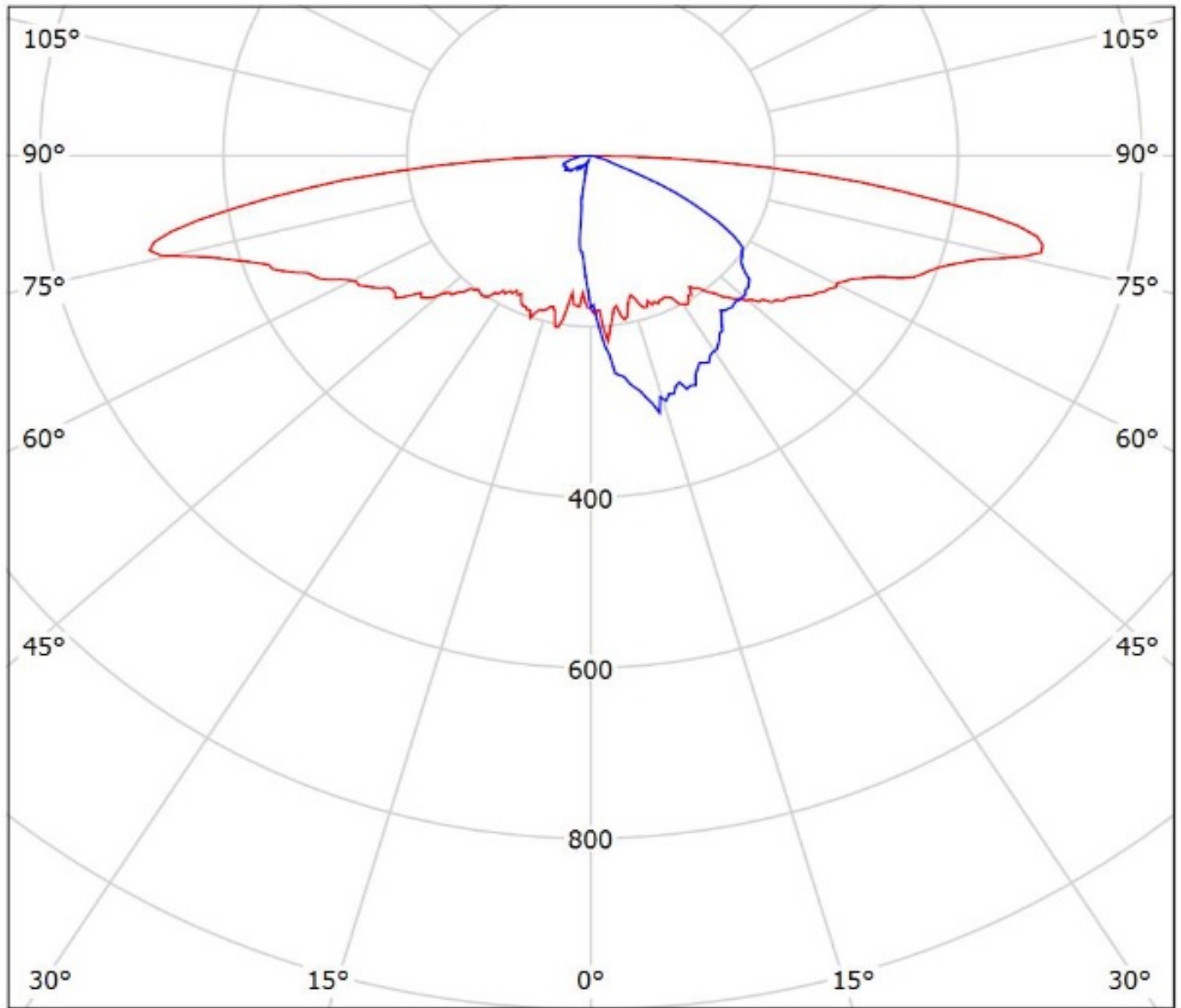

cd/klm

— C0 - C180 — C90 - C270

$\eta = 100\%$

Luminaire: SIMULATED_C15021_STRADA-2X2-SCL_Cree_XM-L2

Lamps: 1 x

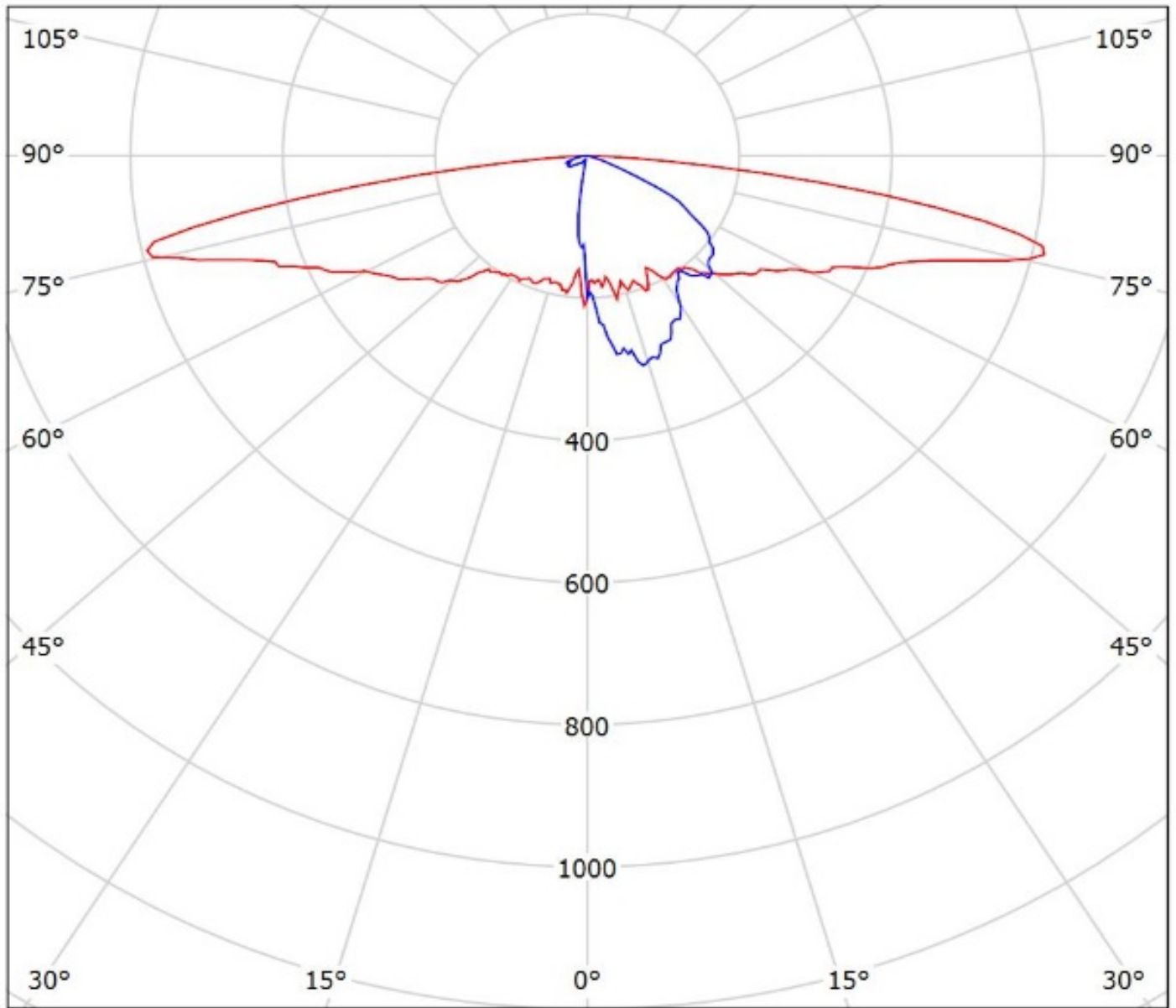

cd/klm

— C0 - C180 — C90 - C270

$\eta = 100\%$

Luminaire: Ledil C15021_STRADA-2X2-SCL (XP-L)
Lamps: 1 x CREE_XP-L_2x2 (XPLAWT-0-1B0-V40-00-0001)
_508.286lm@250mA_CCT=7600K_P=2.8173W_I=0.25A

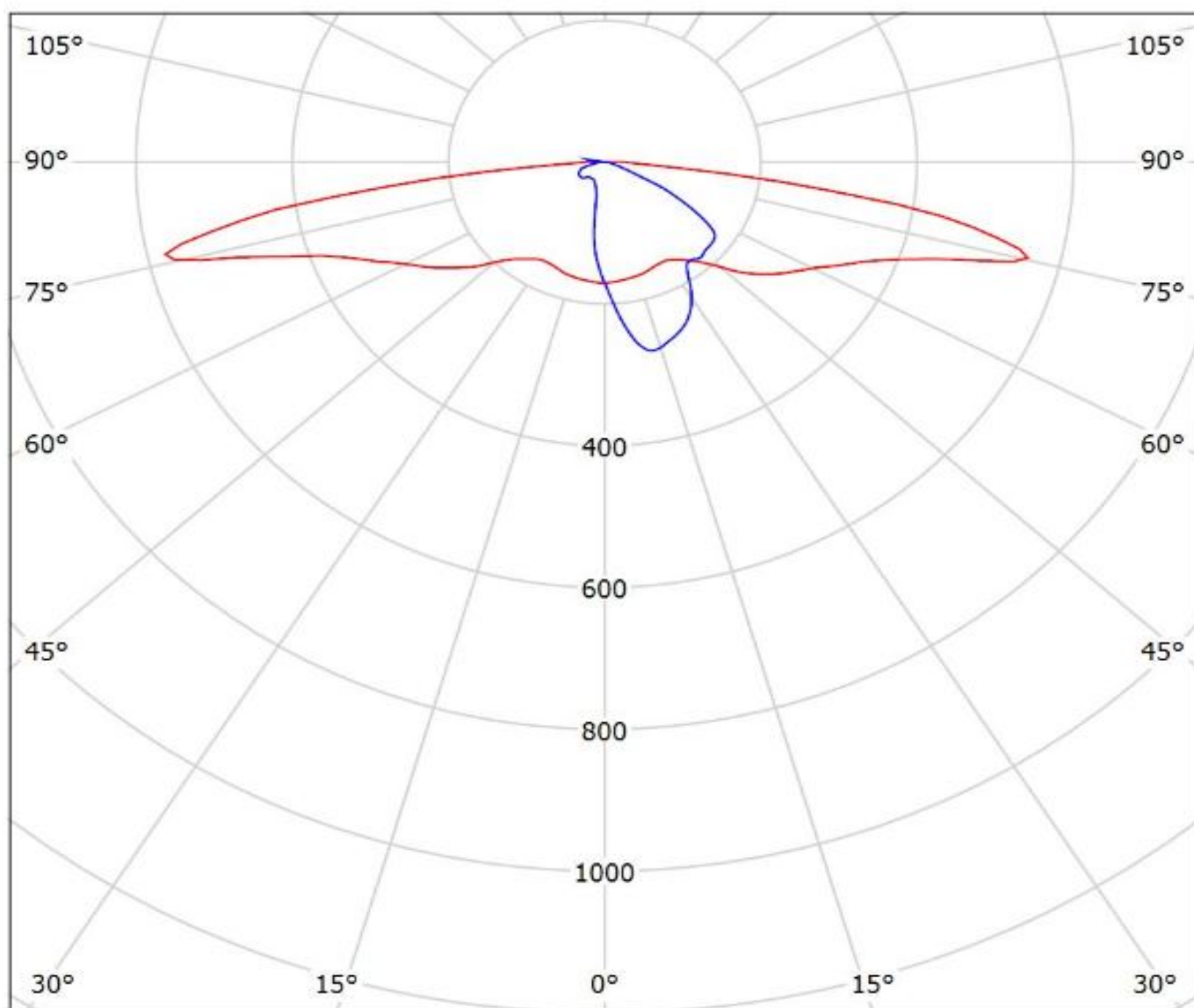

cd/klm

— C0 - C180 — C90 - C270

$\eta = 95\%$

Luminaire: SIMULATED_C15021_STRADA-2X2-SCL_Cree_XP-L-HI
Lamps: 1 x

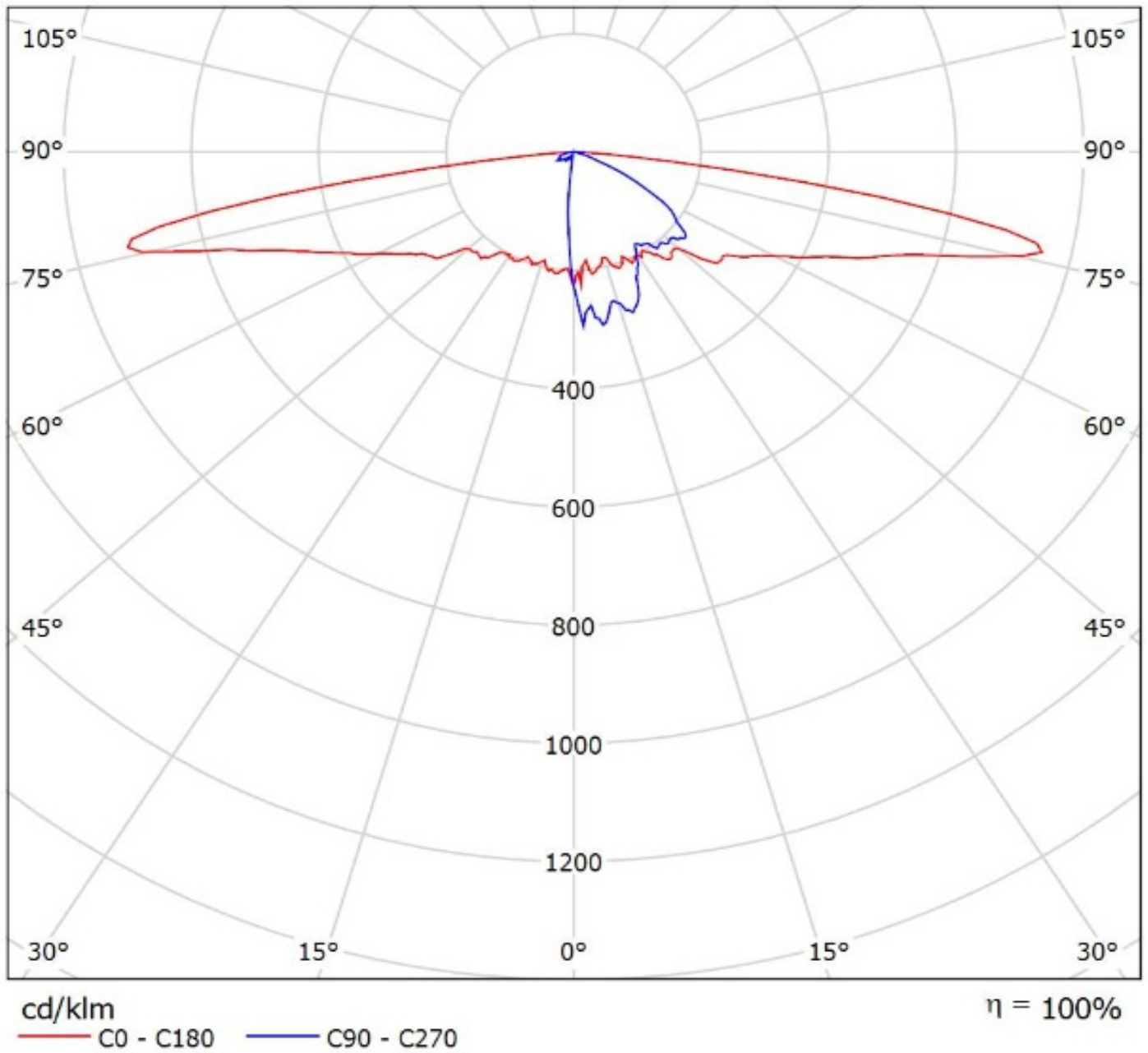

Luminaire: Ledil C15021_STRADA-2X2-SCL_(XP-L)_glass
Lamps: 1 x CREE_XP-L_2x2_(XPLAWT-0-1B0-V40-00-0001)
_508.286lm@250mA_CCT=7600K_P=2.8173W_I=0.25A

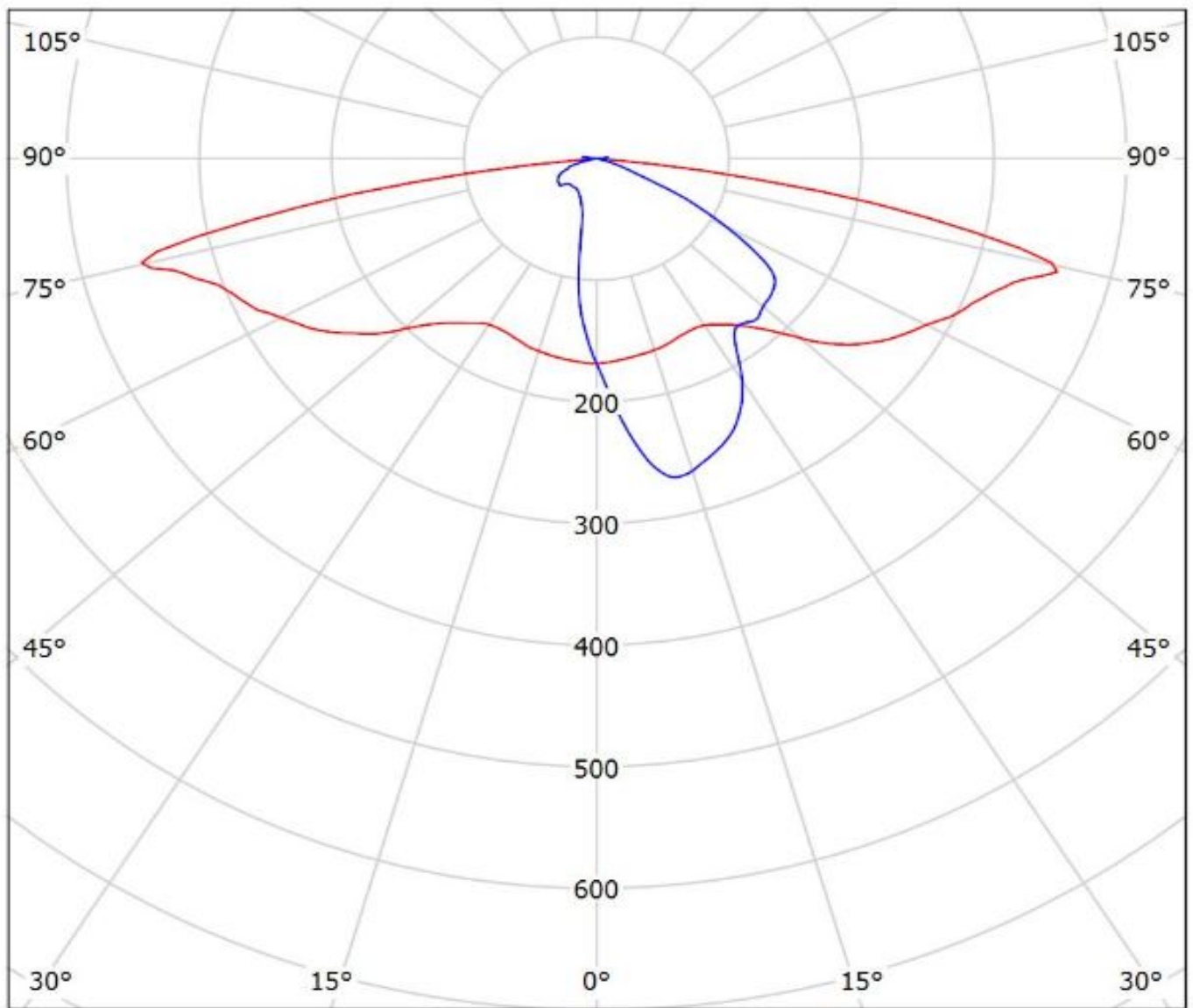

cd/klm
— C0 - C180 — C90 - C270

$\eta = 78\%$

Luminaire: LEDiL Oy C15021_STRADA-2X2-SCL_(XP-G2)

Lamps: 1 x Cree_XP-G2_(XPGBWT-L1-000-00-G51)_409.845lm@250mA_P=2.94464_I=0.250A

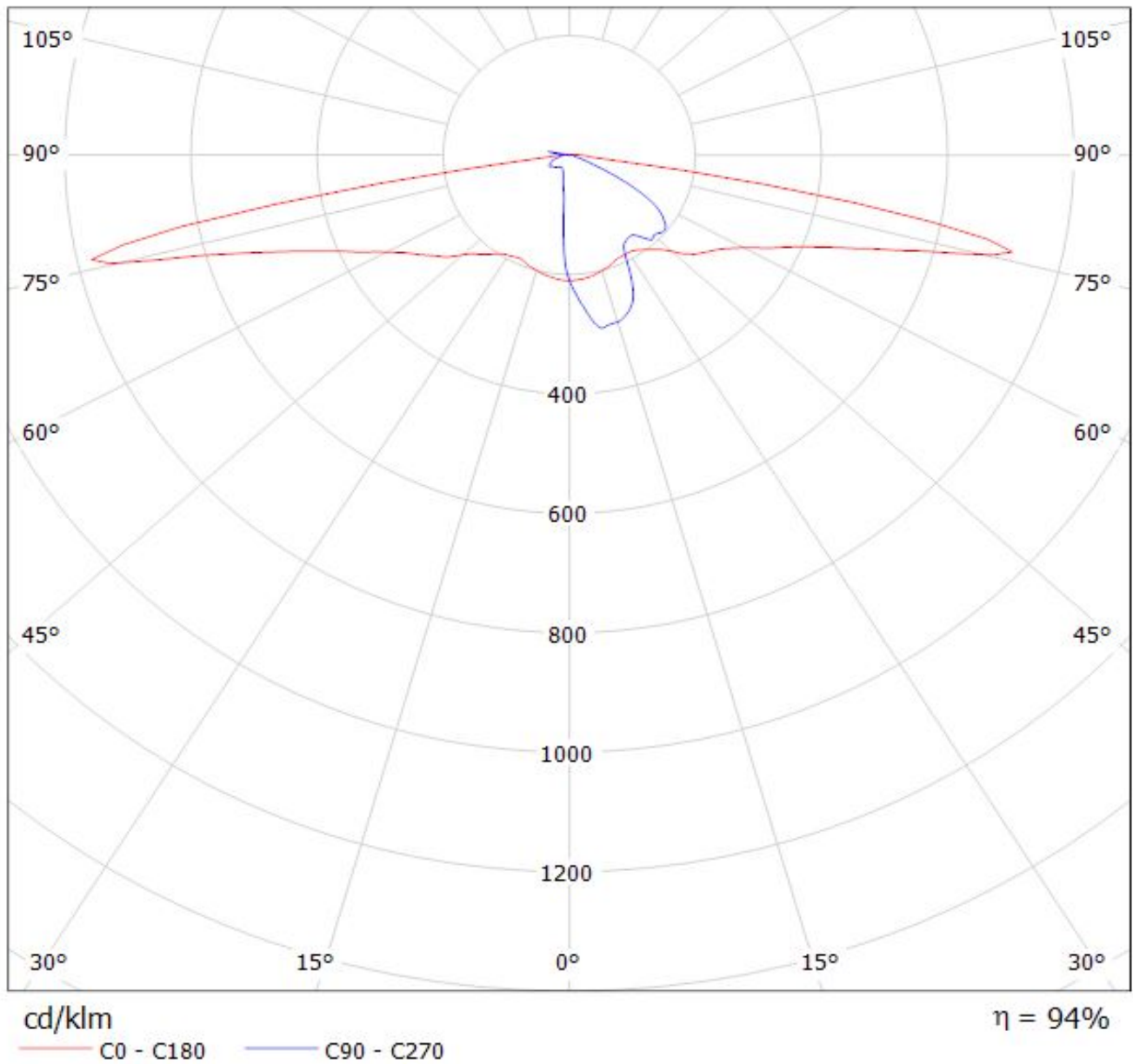

Luminaire: Ledil C15021_STRADA-2X2-SCL_(XP-L2)

Lamps: 1 x Cree_XP-L2_2x2_(XPLBWT-00-0000-000BV50E3)550.93lm@250mA_P=2.7815W_I=0.25A

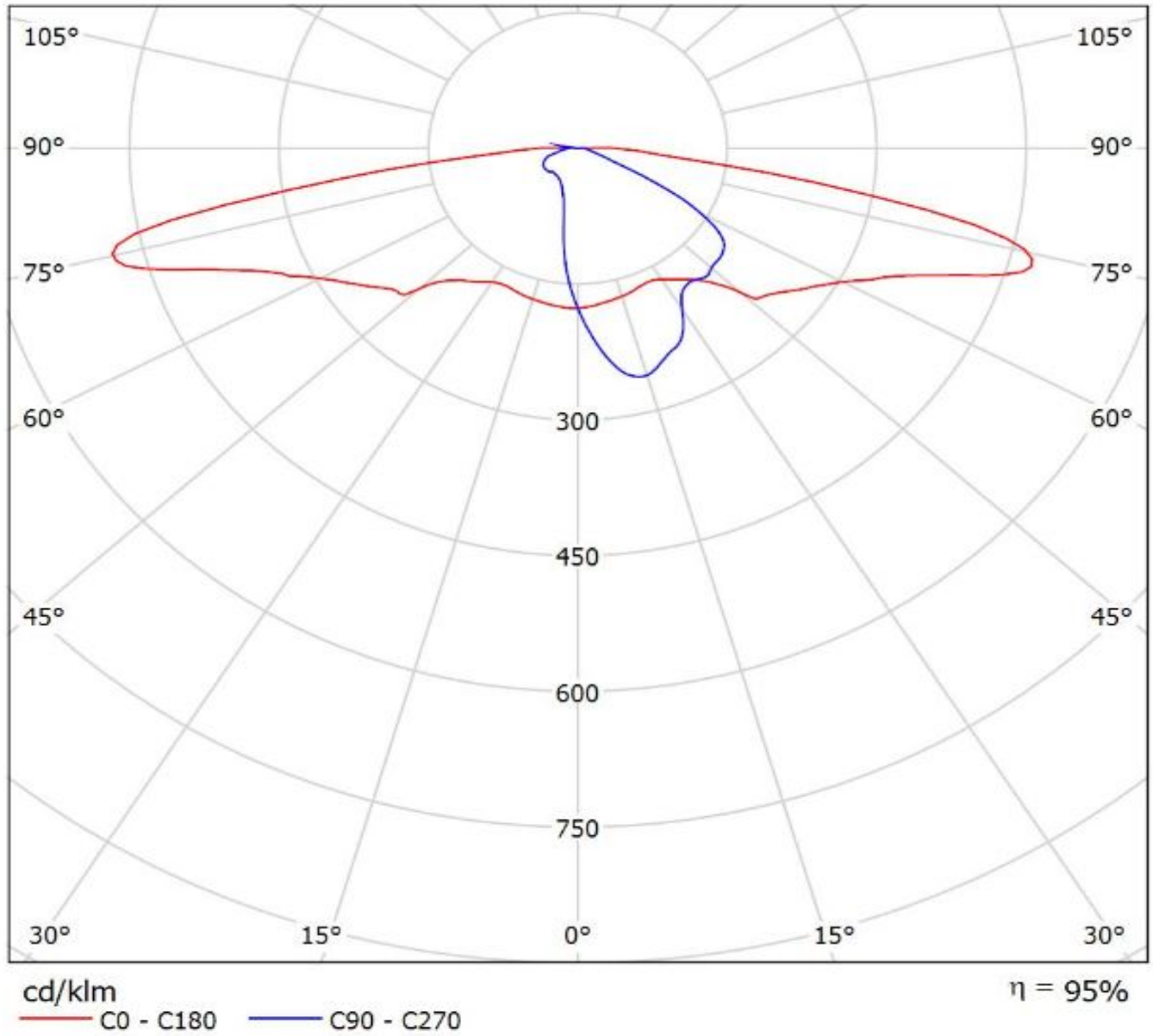

Luminaire: Ledil Oy C15021_STRADA-2X2-SCL_(XP-G3)_SIMULATED
Lamps: 1 x Cree XP-G3

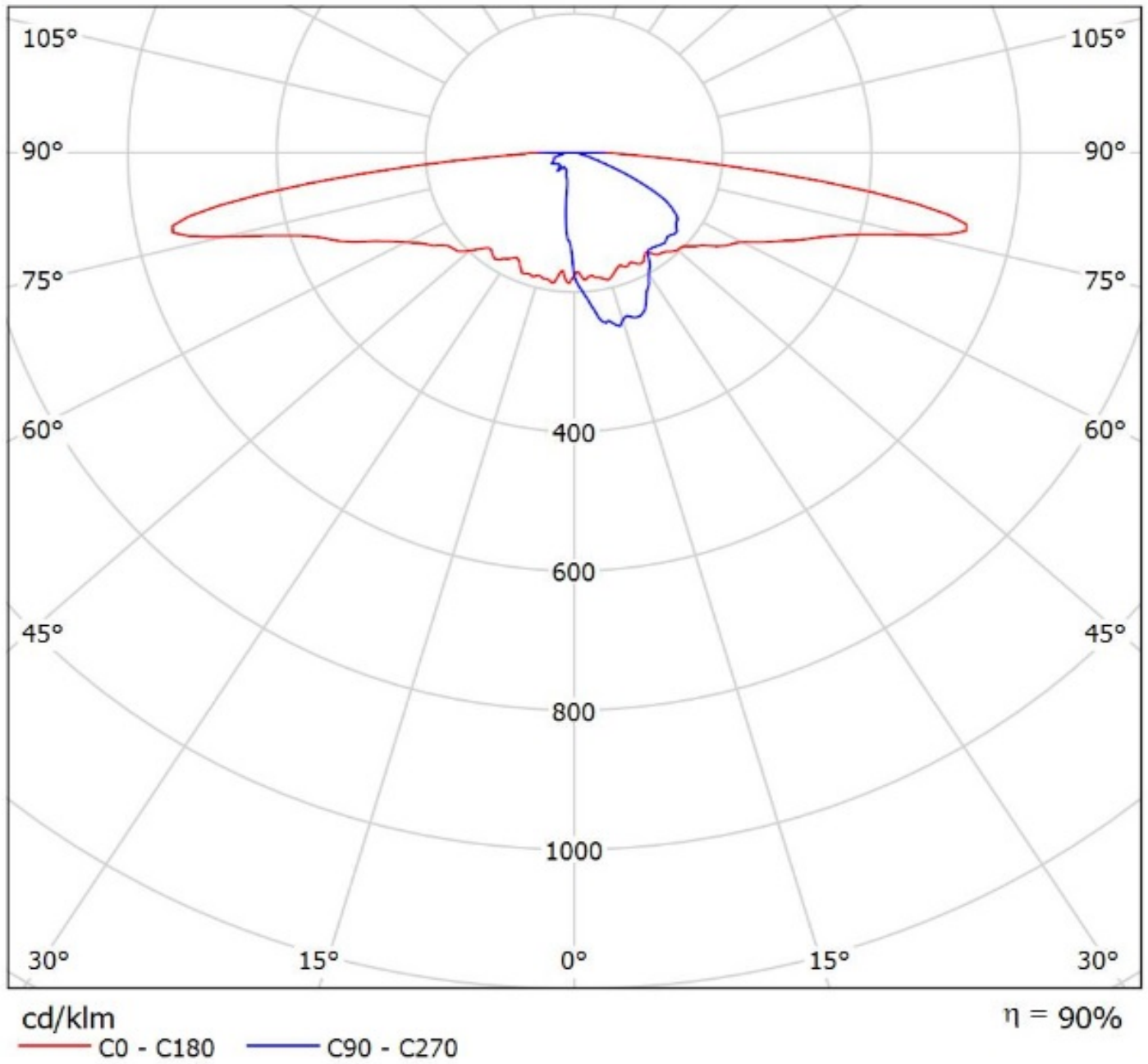

Luminaire: Ledil C15021_STRADA-2X2-SCL_(XD16)

Lamps: 1 x Cree_XD16_2x2_(XD16AWT-H-2B0-S20-0B-002)_453.677lm@250mA_CCT=5700K_P=2.78289W_I=0.25A

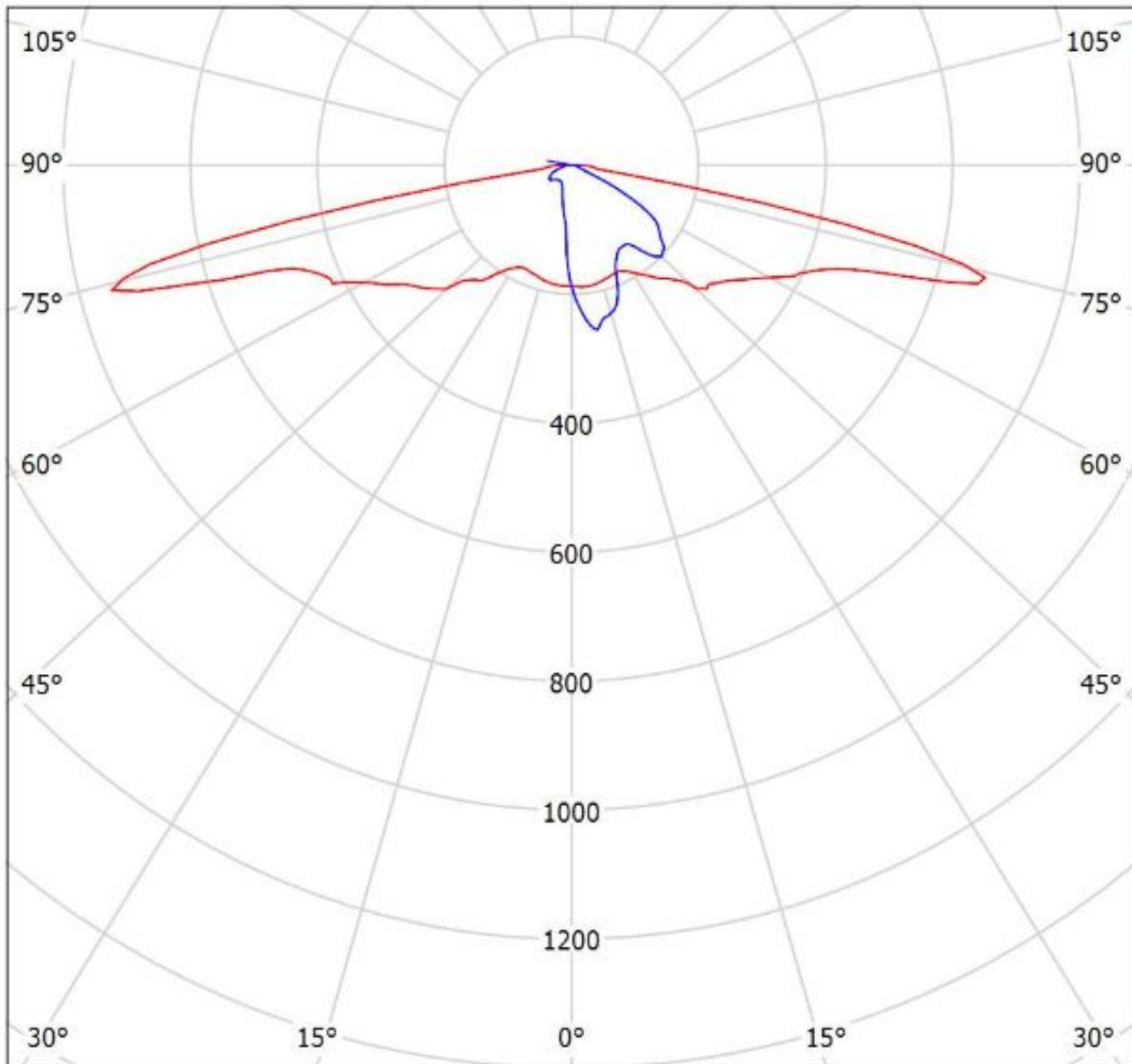

cd/klm

— C0 - C180 — C90 - C270

$\eta = 94\%$

Luminaire: LEDiL Oy C15021_STRADA-2X2-SCL_(XD16_Cluster16)

Lamps: 1 x Cree_XD16_2x2cluster_(XD16AWT-H-2B0-S20-0B-002)_1763.39lm@250mA_CCT=5700K_P=10.926W_U=43.738V

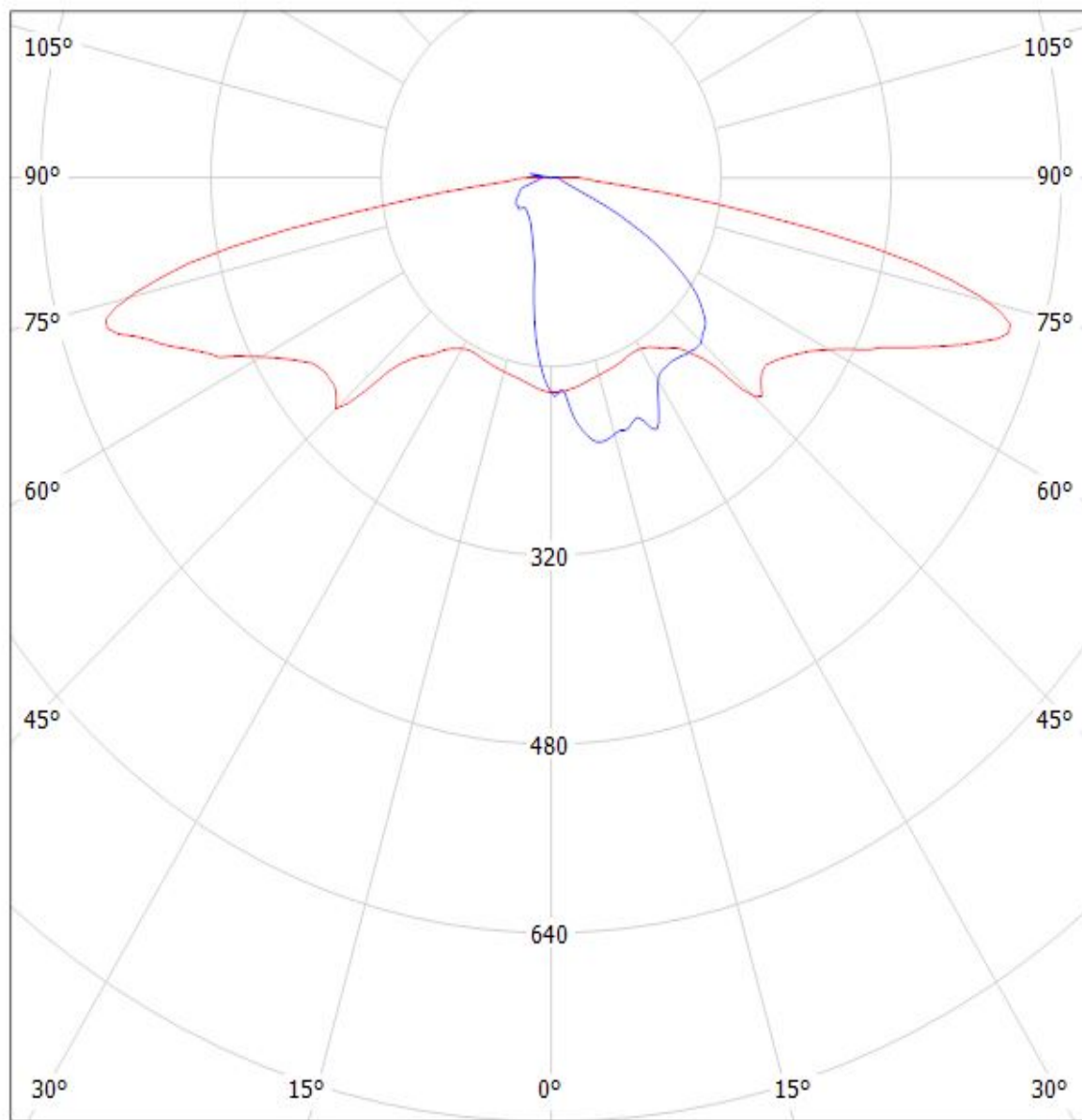

cd/klm

$\eta = 95\%$

— C0 - C180 — C90 - C270

Luminaire: Ledil Oy C15021_STRADA-2X2-SCL_(H35C1)_SIMULATED
Lamps: 1 x LG H35C1 (CCT=5700K)

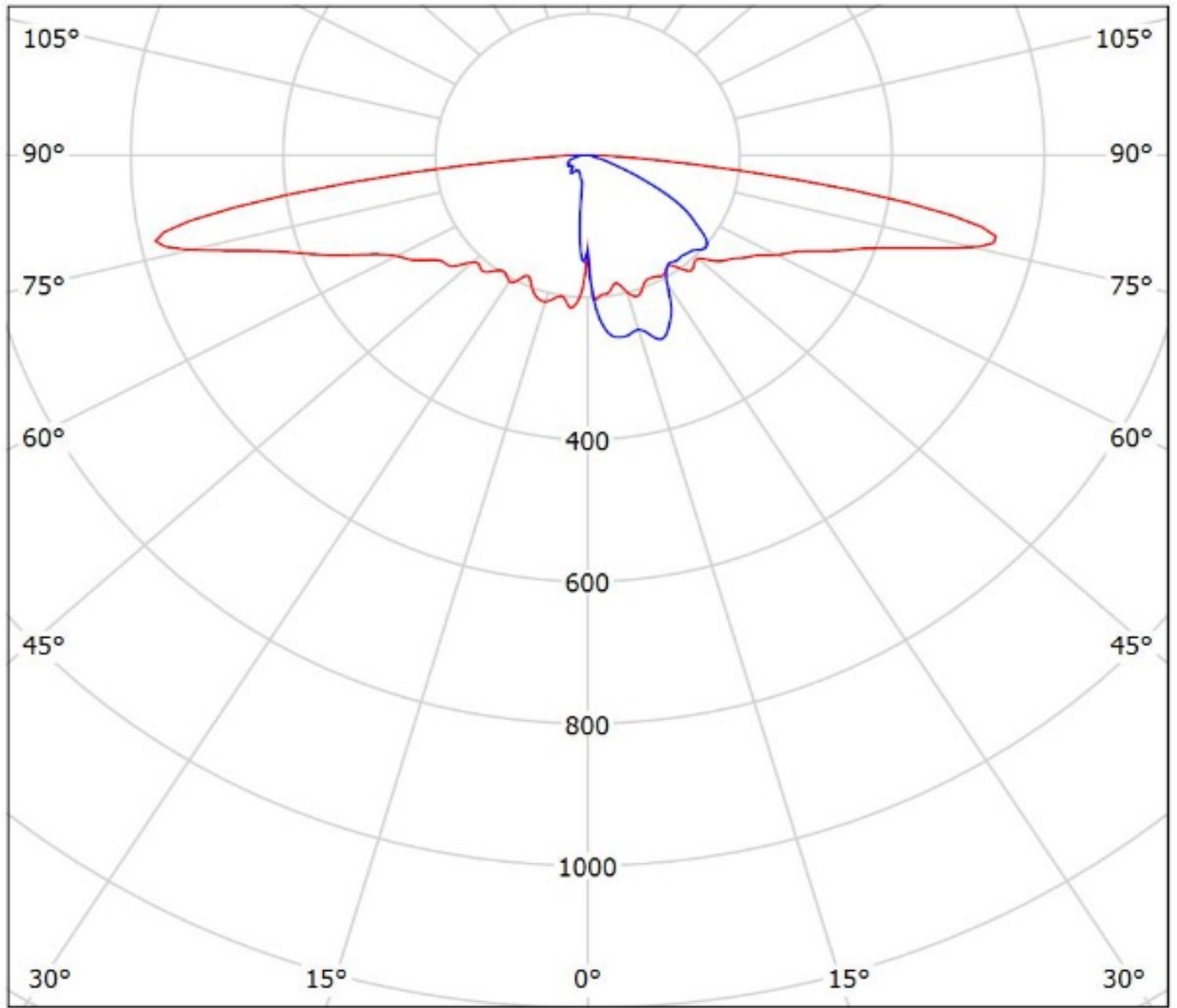

cd/klm
— C0 - C180 — C90 - C270

$\eta = 91\%$

Luminaire: Ledil C15021_STRADA-2X2-SCL_(H35C1)

Lamps: 1 x LG_H35C1_2x2_477.216lm@250mA_P=2.87475W_I=0.250A

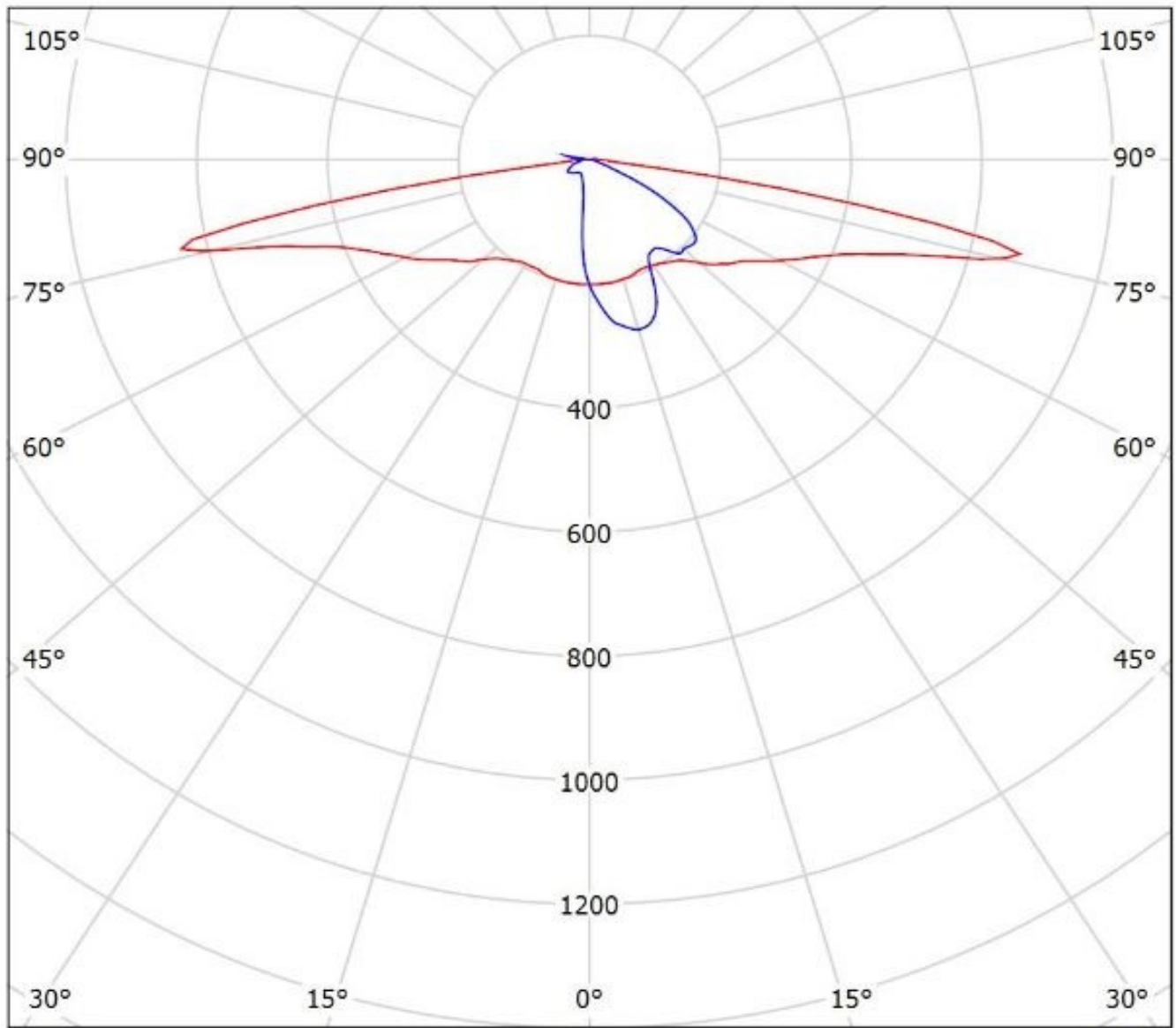

cd/klm

— C0 - C180

— C90 - C270

$\eta = 94\%$

Luminaire: SIMULATED_C15021_STRADA-2X2-SCL_Luxeon-5258

Lamps: 1 x

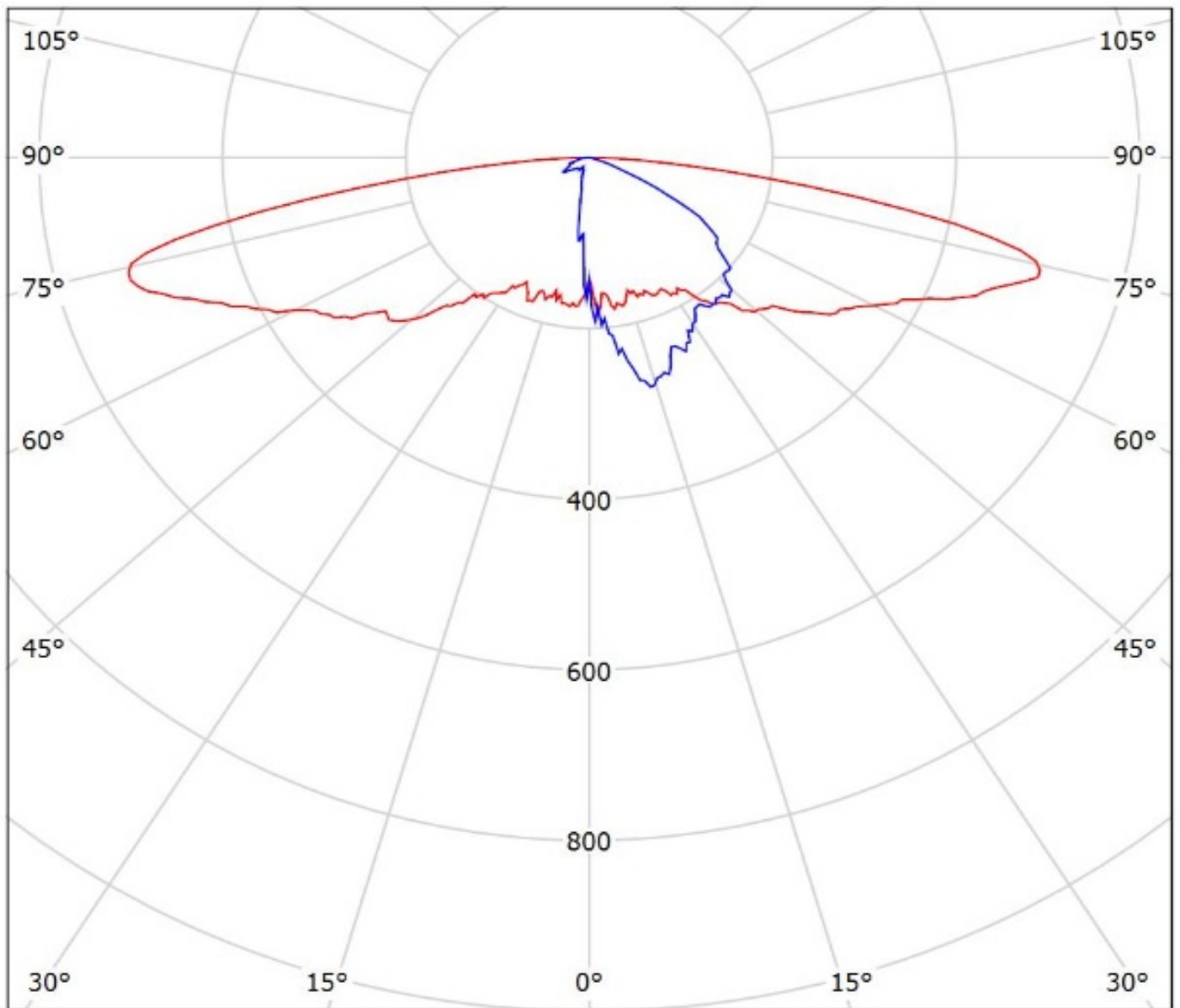

cd/klm

— C0 - C180 — C90 - C270

$\eta = 100\%$

Luminaire: Ledil C15021_STRADA-2X2-SCL_(Luxeon_TX)
Lamps: 1 x Luxeon_TX_(L1T2-3585)_lm@250mA_P=W_l=0.250A

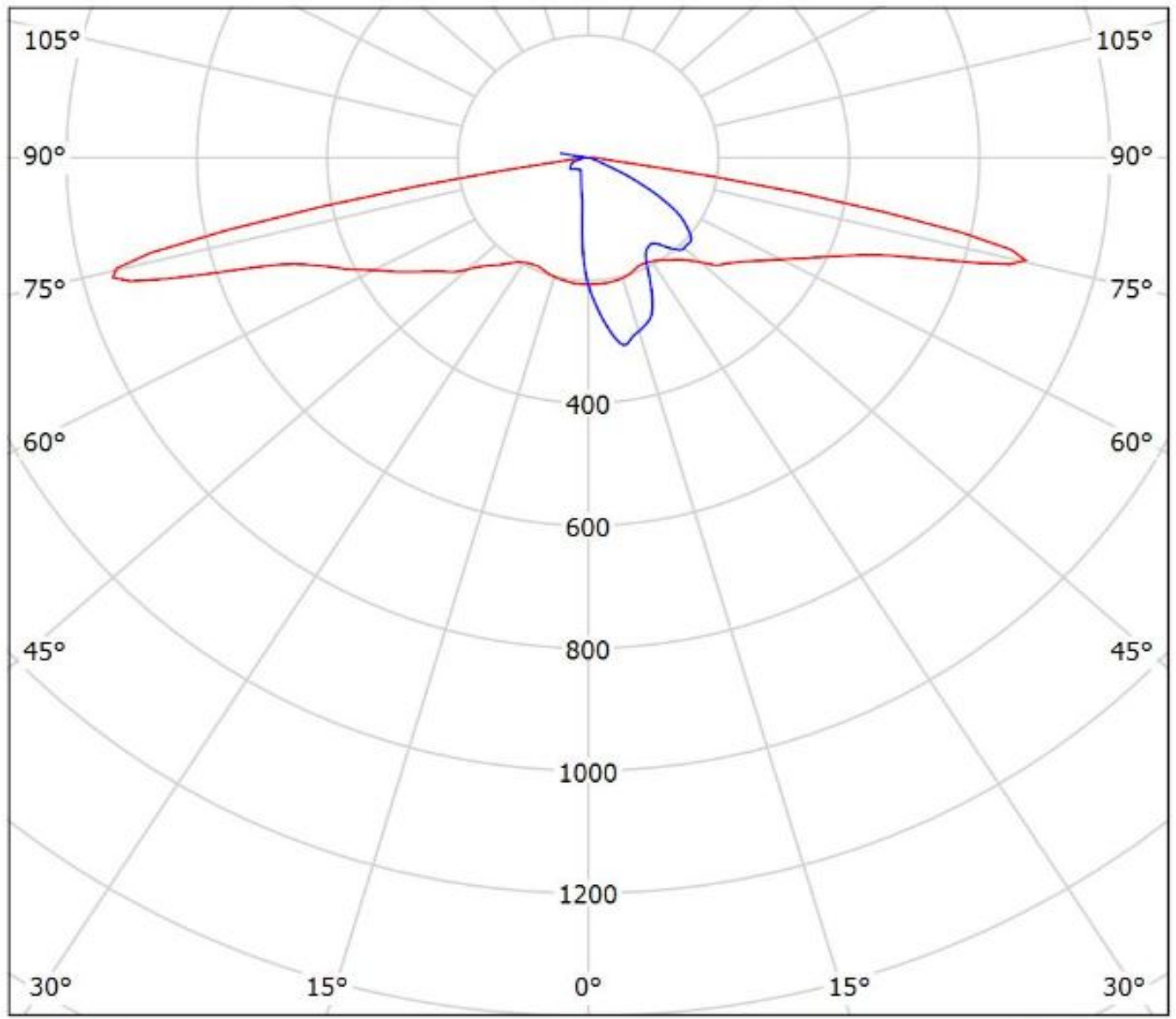

cd/klm

— C0 - C180 — C90 - C270

$\eta = 95\%$

Luminaire: LEDiL Oy C15021_STRADA-2X2-SCL_(Luxeon_5050)

Lamps: 1 x Luxeon_5050_2x2_1270.76lm@80mA_CCT=5700K_P=7.35815W_I=0.080A_70CRI

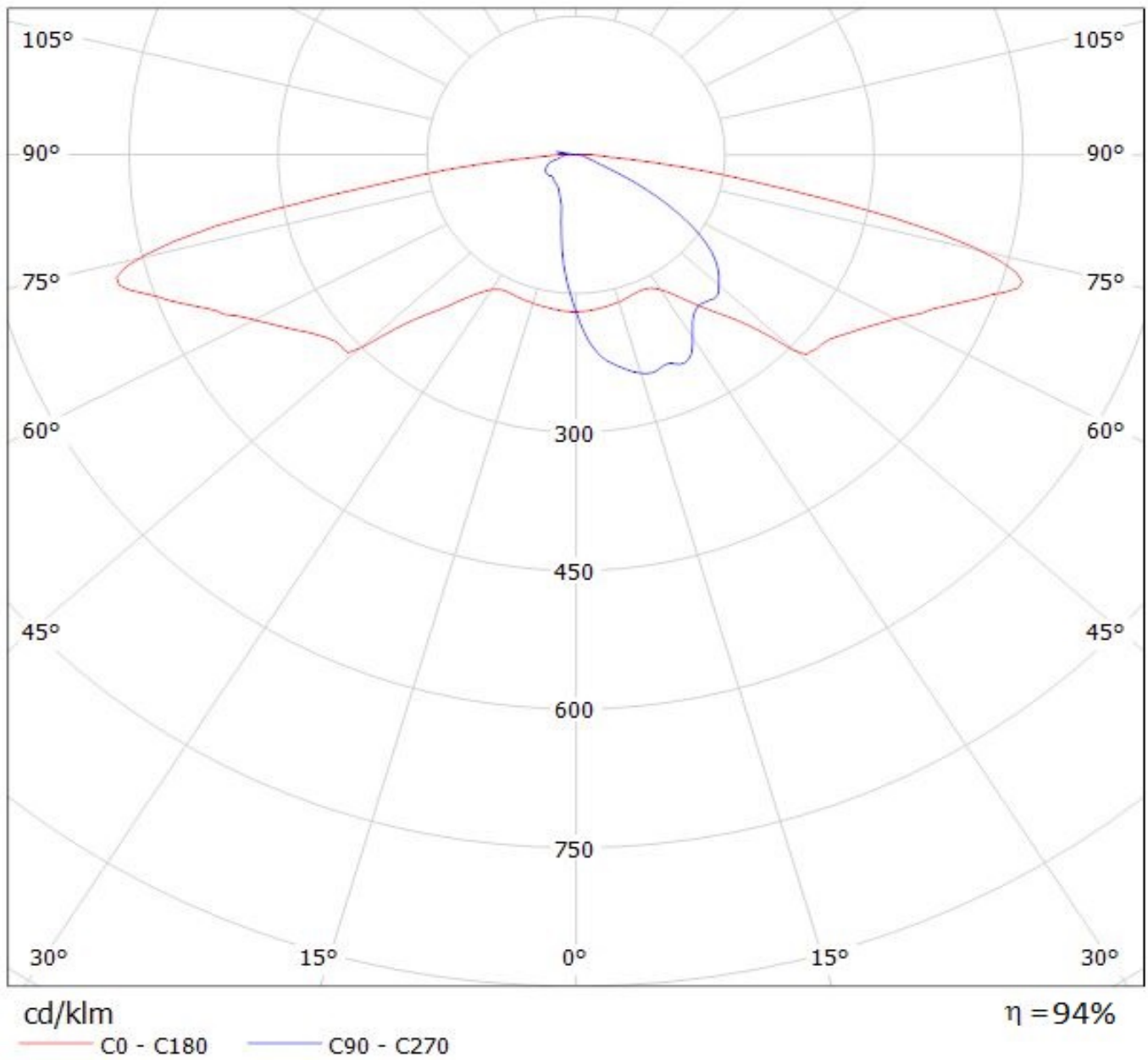

Luminaire: LEDiL Oy C15021_STRADA-2X2-SCL_(Luxeon_V)

Lamps: 1 x Lumileds_Luxeon_V_2x2_486.24lm@250mA_CCT=4000K_P=2.7538W_I=0.250A

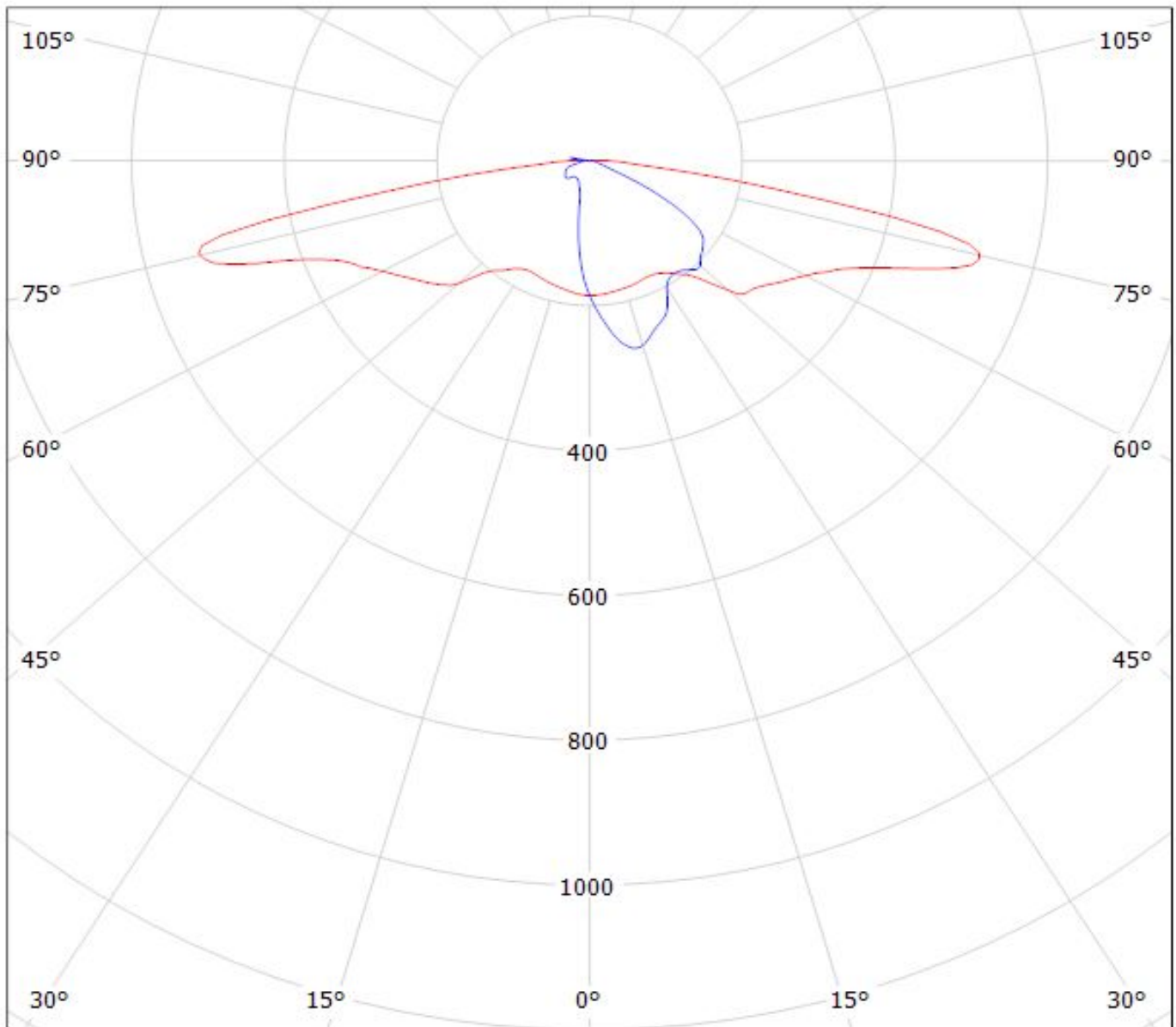

cd/klm

— C0 - C180

— C90 - C270

$\eta = 95\%$

Luminaire: Ledil Oy C15021_STRADA-2X2-SCL_(NVSxx19C)_SIMULATED
Lamps: 1 x Nichia NVSxx19C

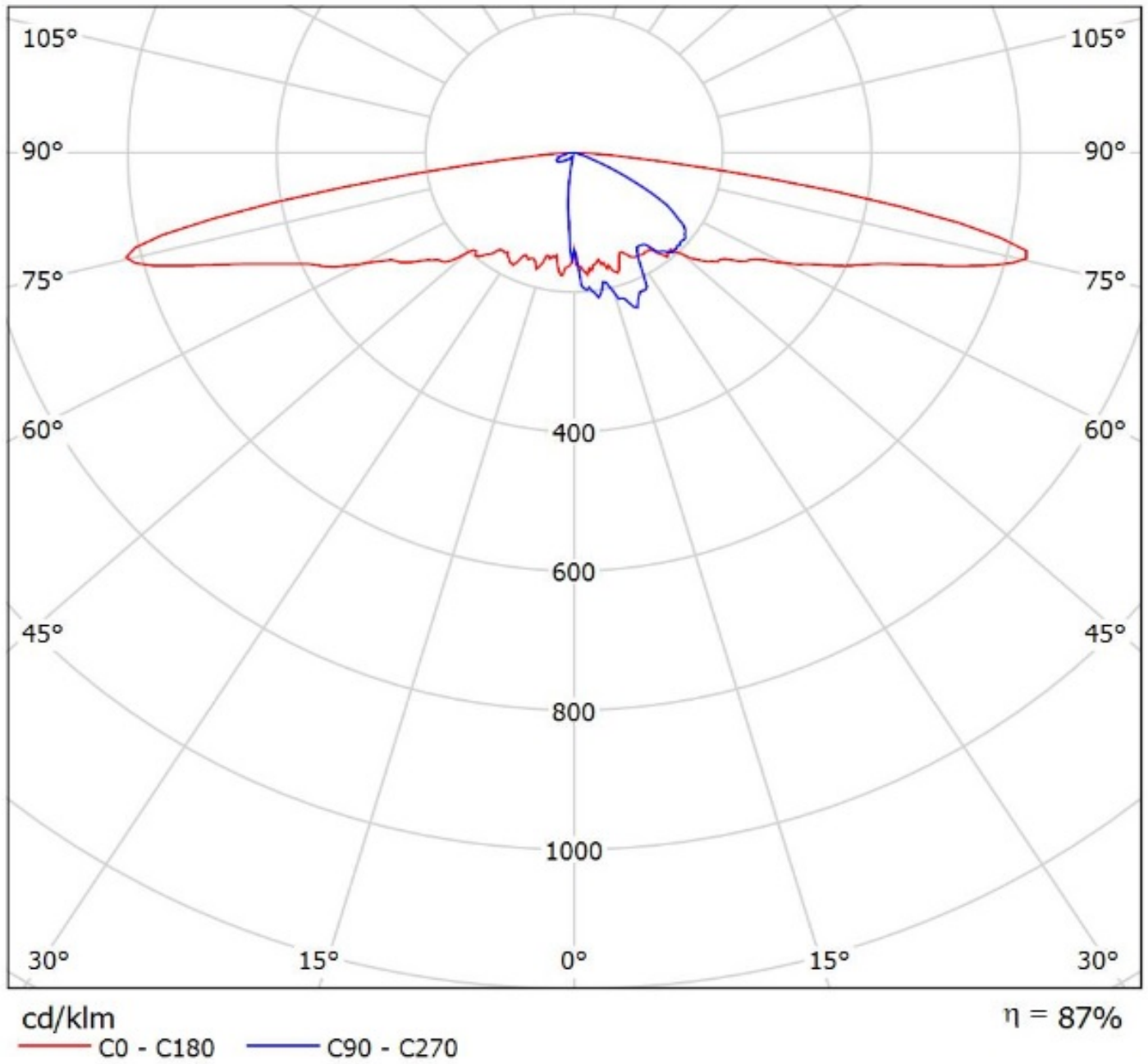

Luminaire: LEDiL Oy C15021_STRADA-2X2-SCL_(E21A)

Lamps: 1 x Nichia_E21A_452.248lm@250mA_2.805W_I=0.250A

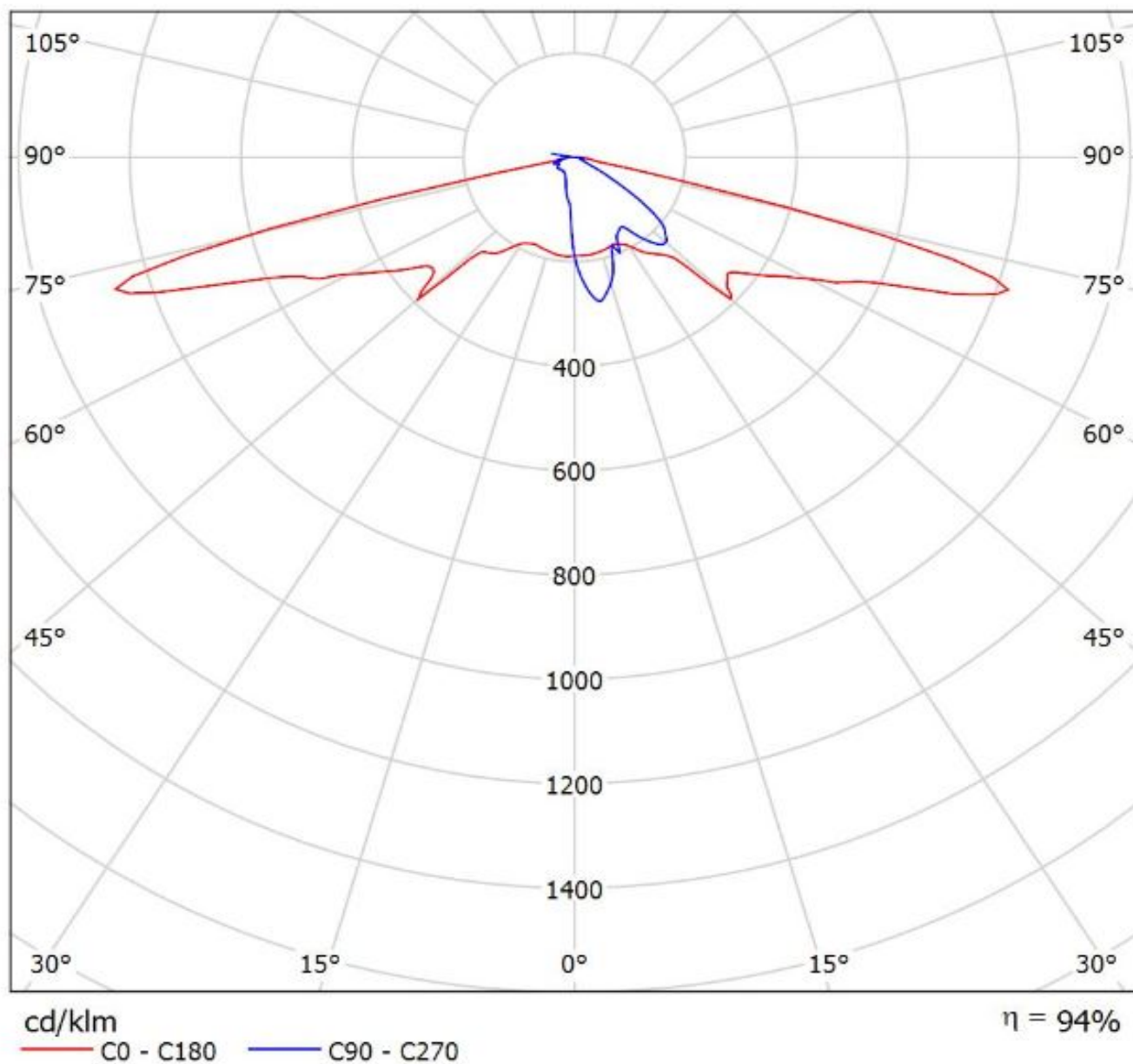

Luminaire: LEDiL Oy C15021_STRADA-2X2-SCL_(NVSW319AE)
Lamps: 1 x Nichia_NVSW319AE_499.093lm@250mA_P=2.79052W_I=0.25A

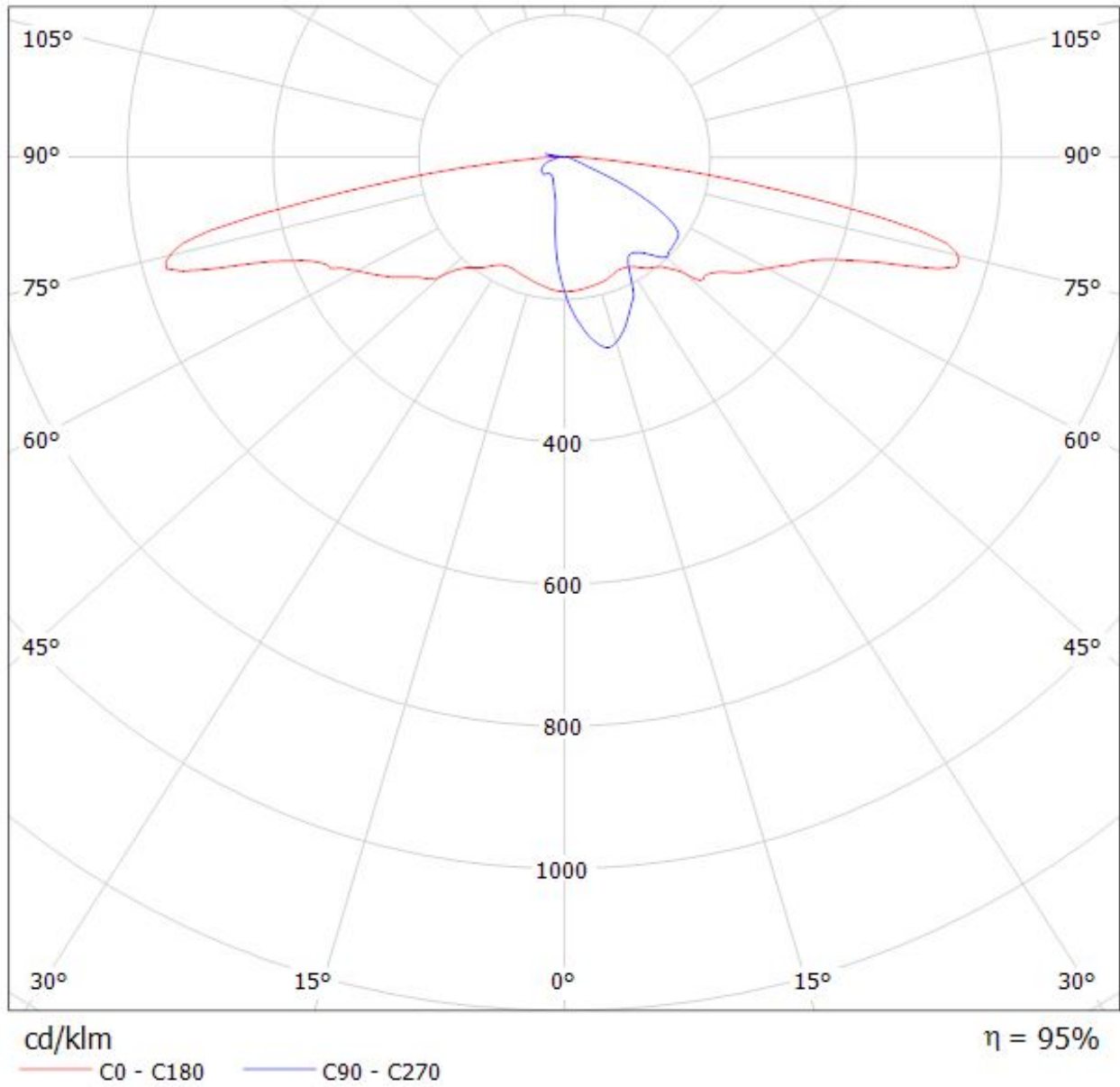

Luminaire: Ledil Oy C15021_STRADA-2X2-SCL_with_glass_SIMULATED
Lamps: 1 x Nichia_NVSL219B-V1(3000K, R8000)

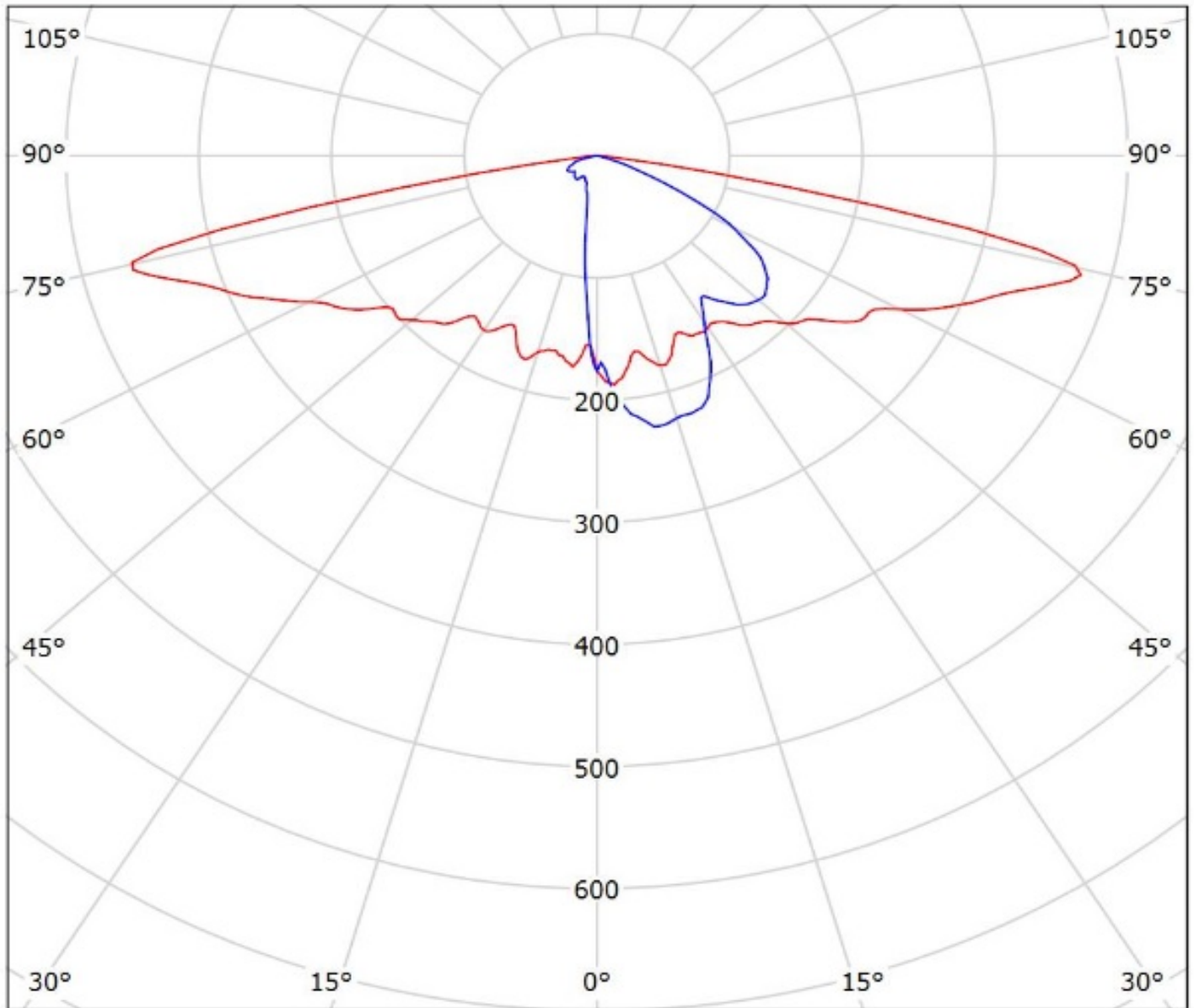

cd/klm

— C0 - C180 — C90 - C270

$\eta = 69\%$

Luminaire: Ledil Oy C15021_STRADA-2X2-SCL_(Duris_S8)_SIMULATED
Lamps: 1 x Osram Duris S8 (GW P9LM21.EM)

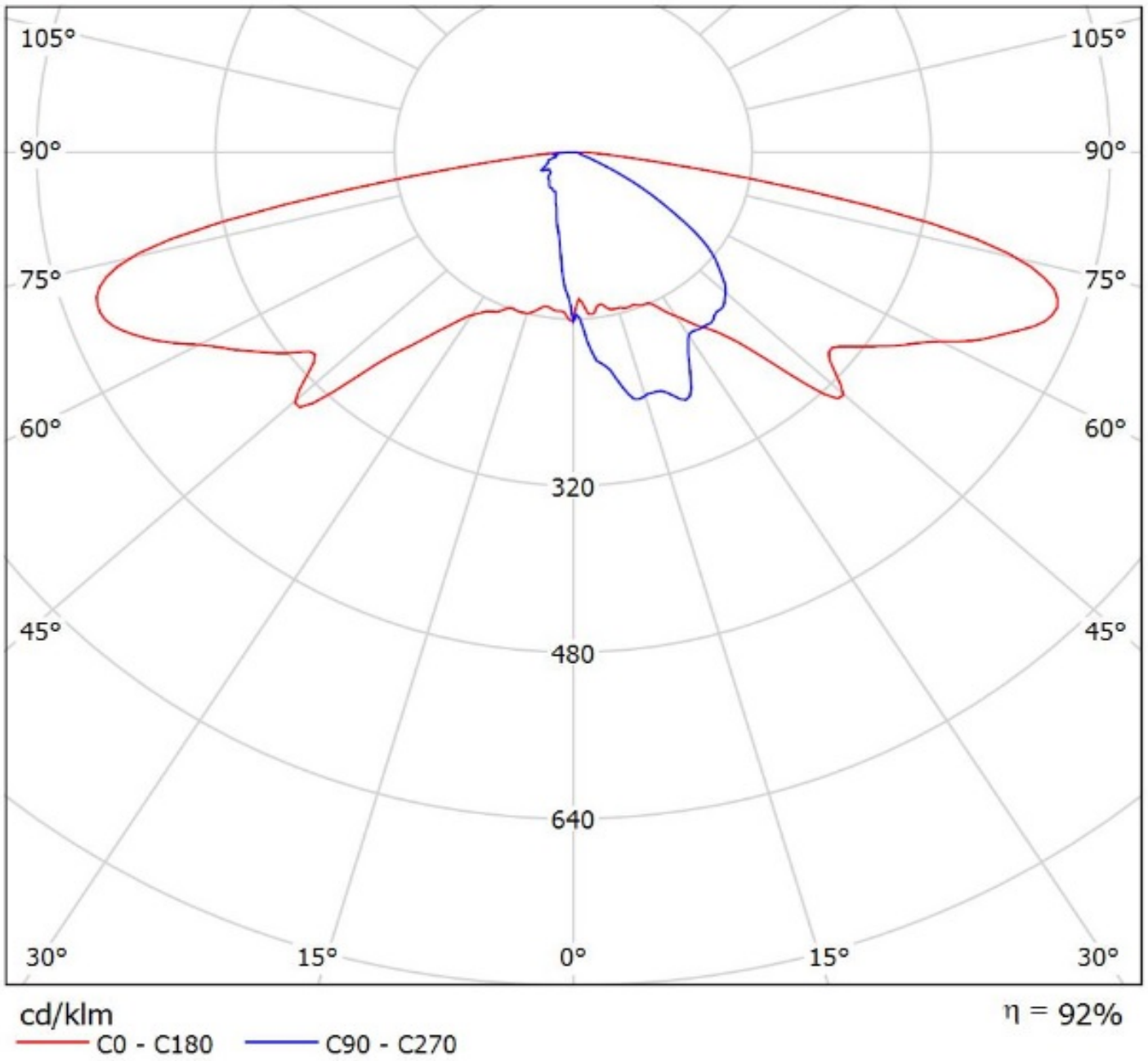

Ledil C15021_STRADA-2X2-SCL_(SQ-PC) / LDC (Polar)

Luminaire: Ledil C15021_STRADA-2X2-SCL_(SQ-PC)
Lamps: 1 x Osram_Oslon_Square-PC_2x2_(GW_CSSRM1.PC)
_421.516lm@250mA_CCT=5201K_P=2.8653W_I=0.25A

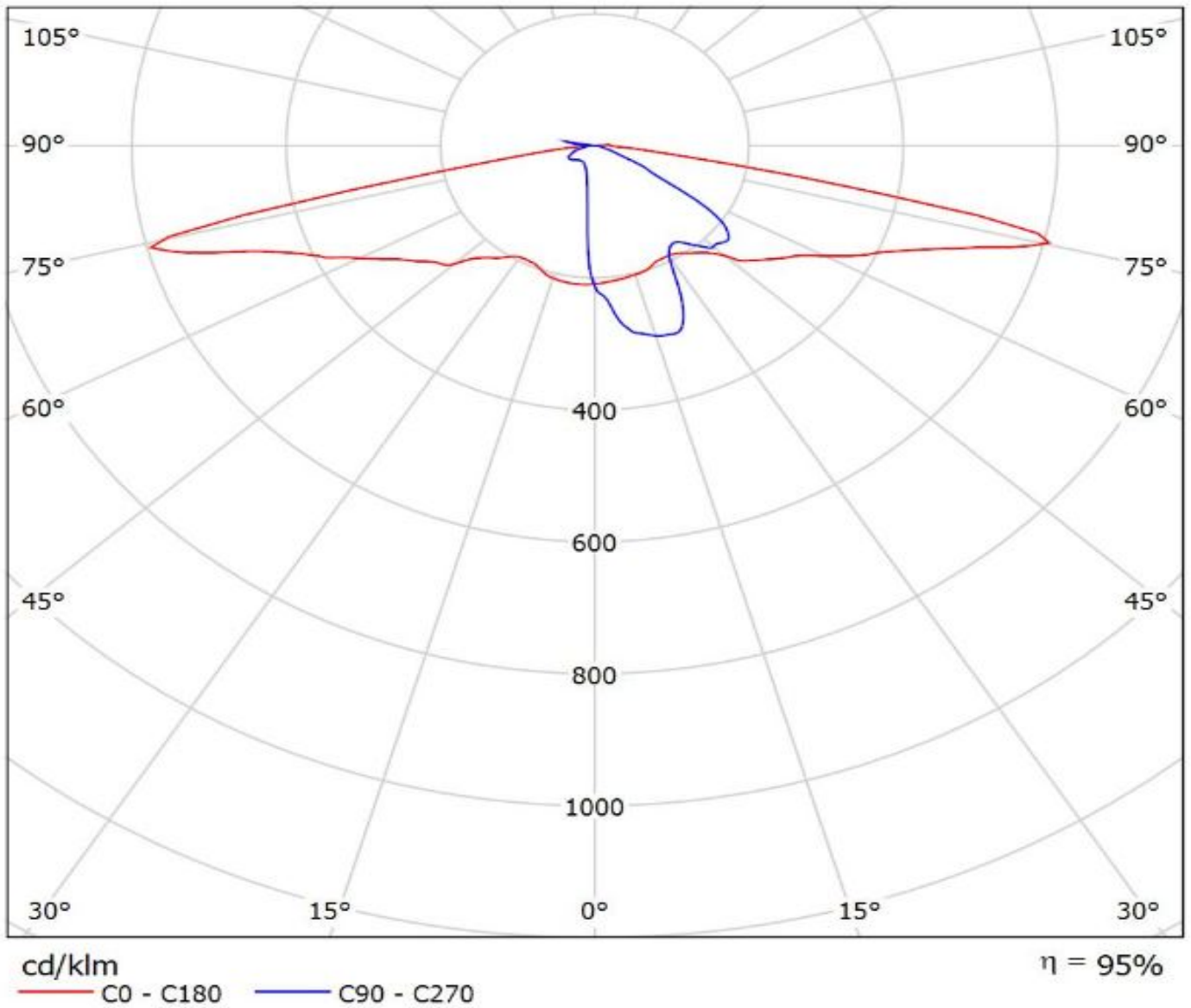

Luminaire: Ledil C15021_STRADA-2X2-SCL_(Square_Gen3)

Lamps: 1 x Osram_Square_Gen3_(GW_CSSRM2.PM)_461.082lm@250mA_P=2.79075W_I=0.250A

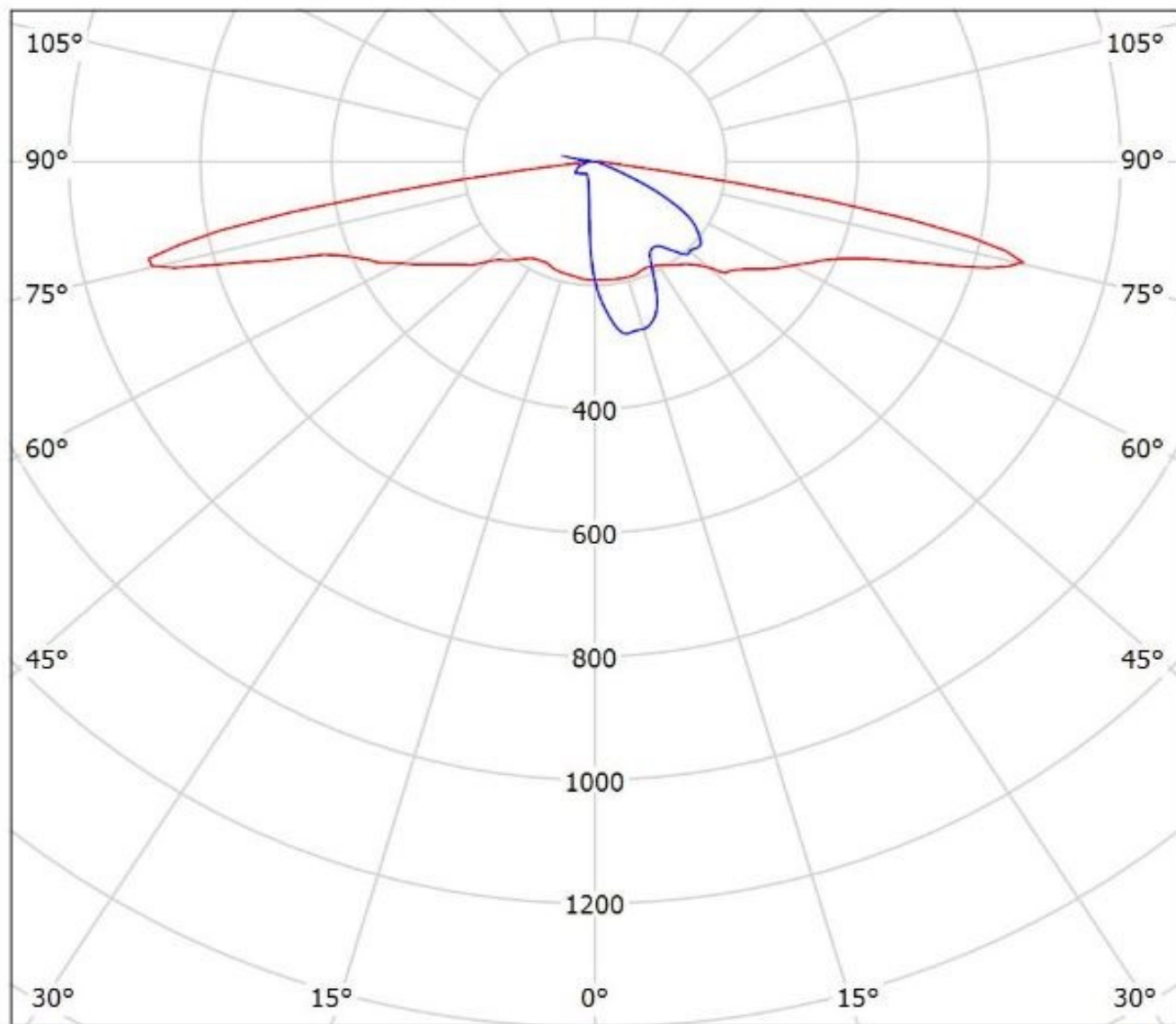

cd/klm

$\eta = 94\%$

— C0 - C180

— C90 - C270

Luminaire: Ledil Oy C15021_STRADA-2X2-SCL_OSRAM_DURIS_P9_SIMULATED
Lamps: 1 x OSRAM DURIS P9

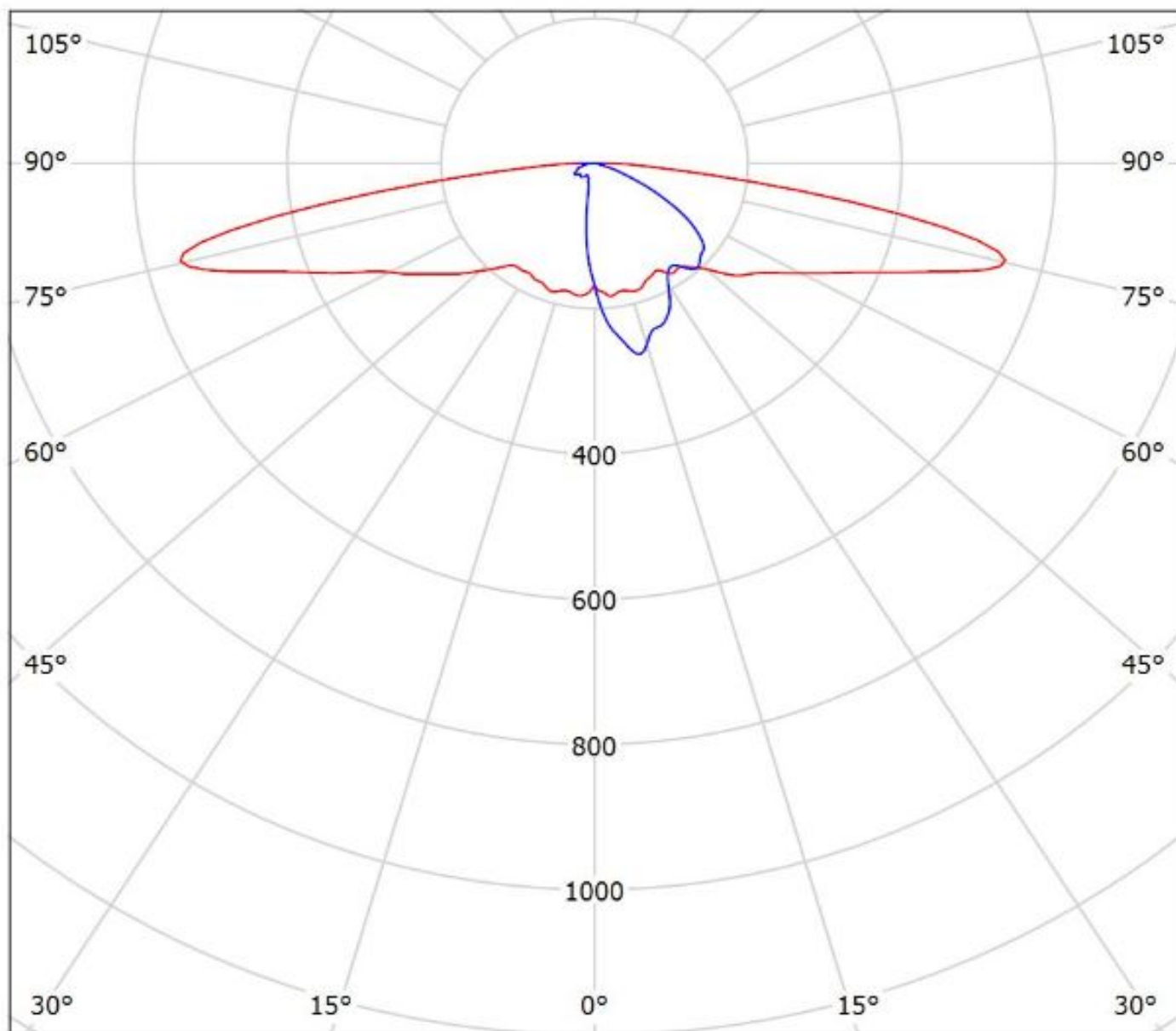

cd/klm

— C0 - C180 — C90 - C270

$\eta = 91\%$

Luminaire: Ledil C15021_STRADA-2X2-SCL_(Fortimo_FastFlex_LED_board_2x8/740_DA_G3)
Lamps: 1 x Fortimo_FastFlex_LED_board_2x8/740_DA_G3_1828.23lm@250mA_P=11.667W_I=0.25A

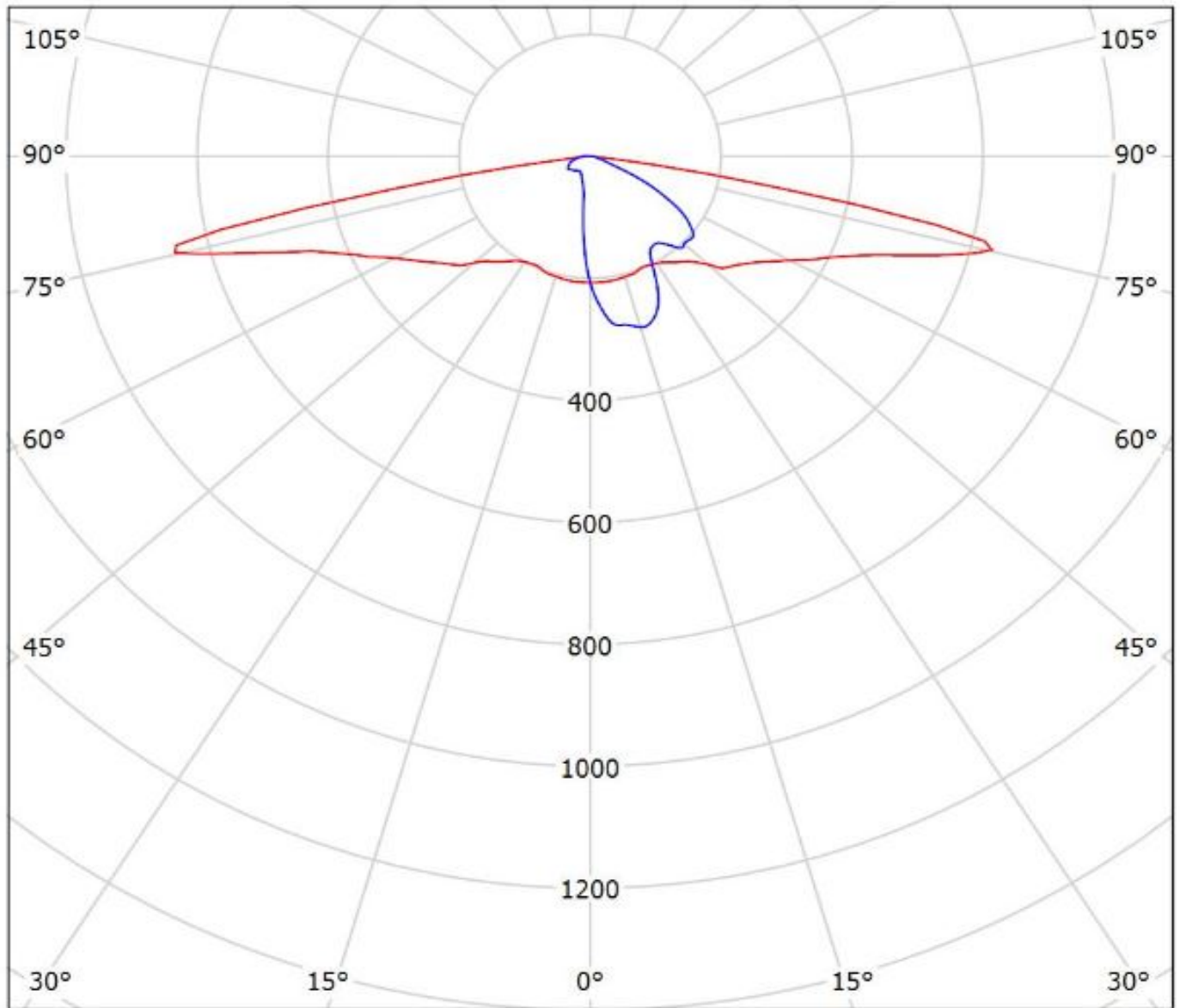

cd/klm

— C0 - C180

— C90 - C270

$\eta = 95\%$

Luminaire: Ledil Oy C15021_STRADA-2X2-SCL_Fortimo FastFlex LED board 2x8 DAX G4_SIMULATED
Lamps: 1 x Fortimo FastFlex LED board 2x8 DAX G4

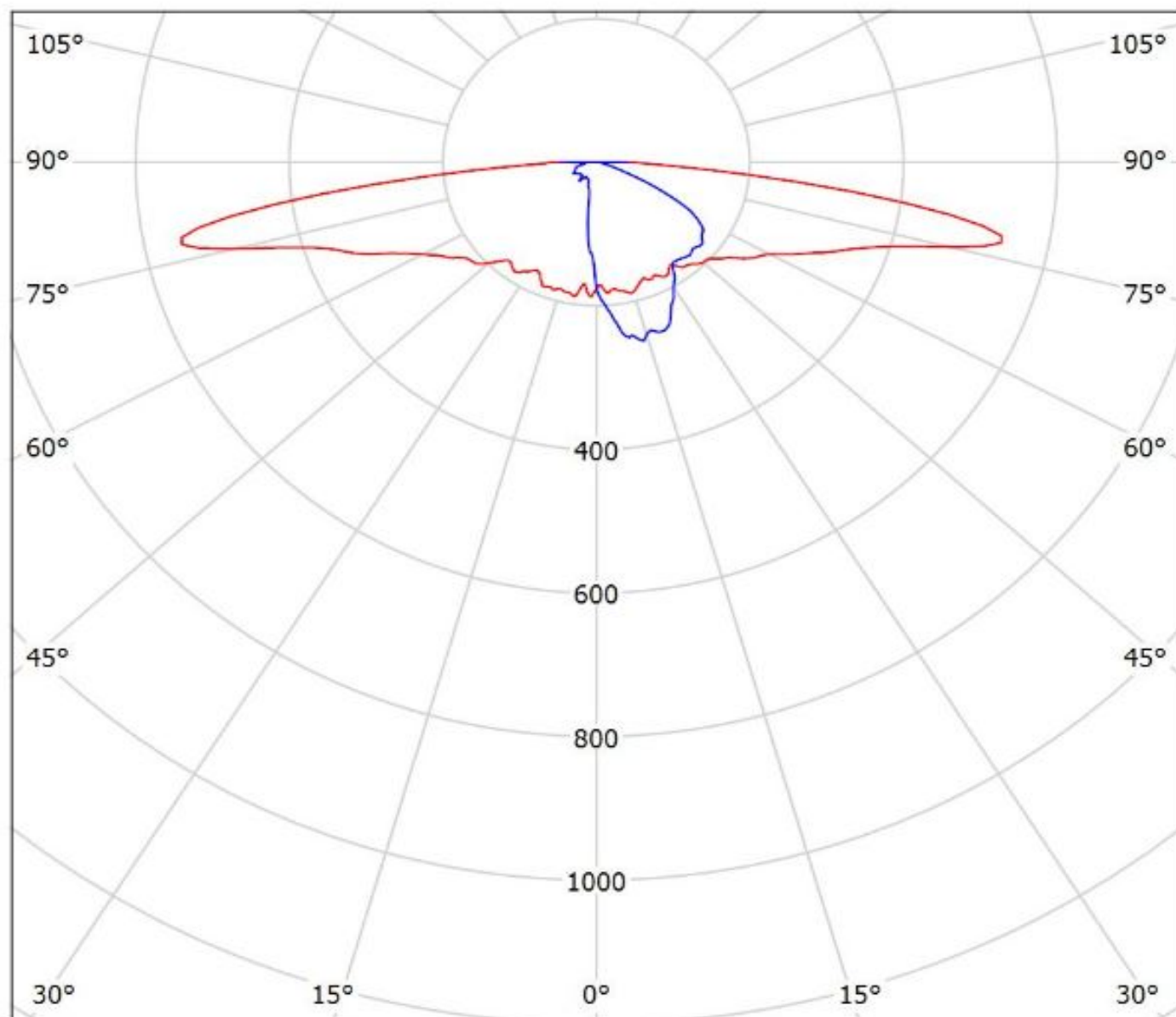

cd/klm

— C0 - C180

— C90 - C270

$\eta = 90\%$

Luminaire: Ledil C15021_STRADA-2X2-SCL_(LH351B)

Lamps: 1 x Samsung_LH351B_2x2_444.178lm@250mA_P=2.8535W_I=0.25A

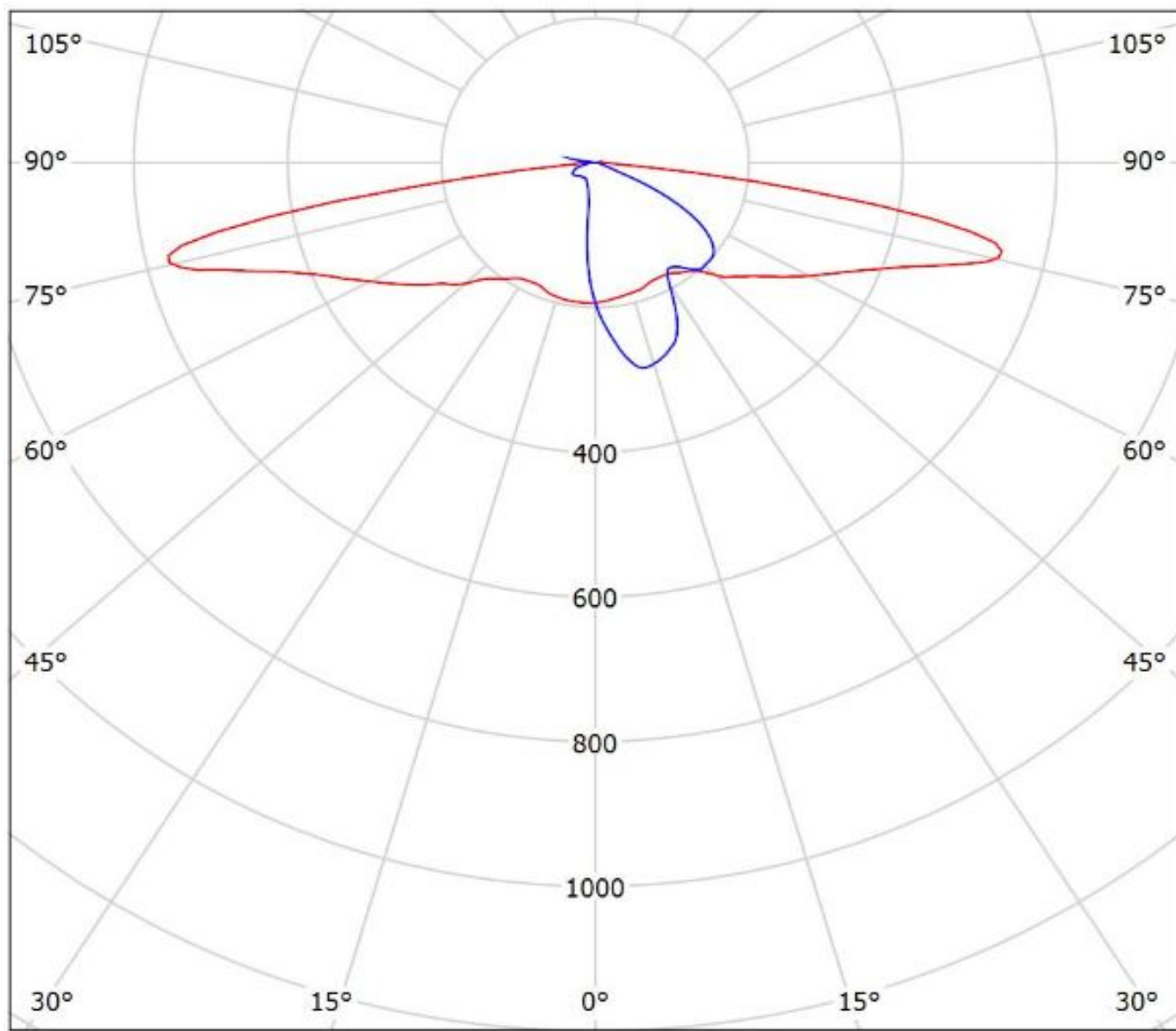

cd/klm

— C0 - C180 — C90 - C270

$\eta = 95\%$

Luminaire: LEDiL Oy C15021_STRADA-2X2-SCL_(LH351D)
Lamps: 1 x Samsung_LH351D_524.264lm@250mA_P=2.7523W_I=0.250A

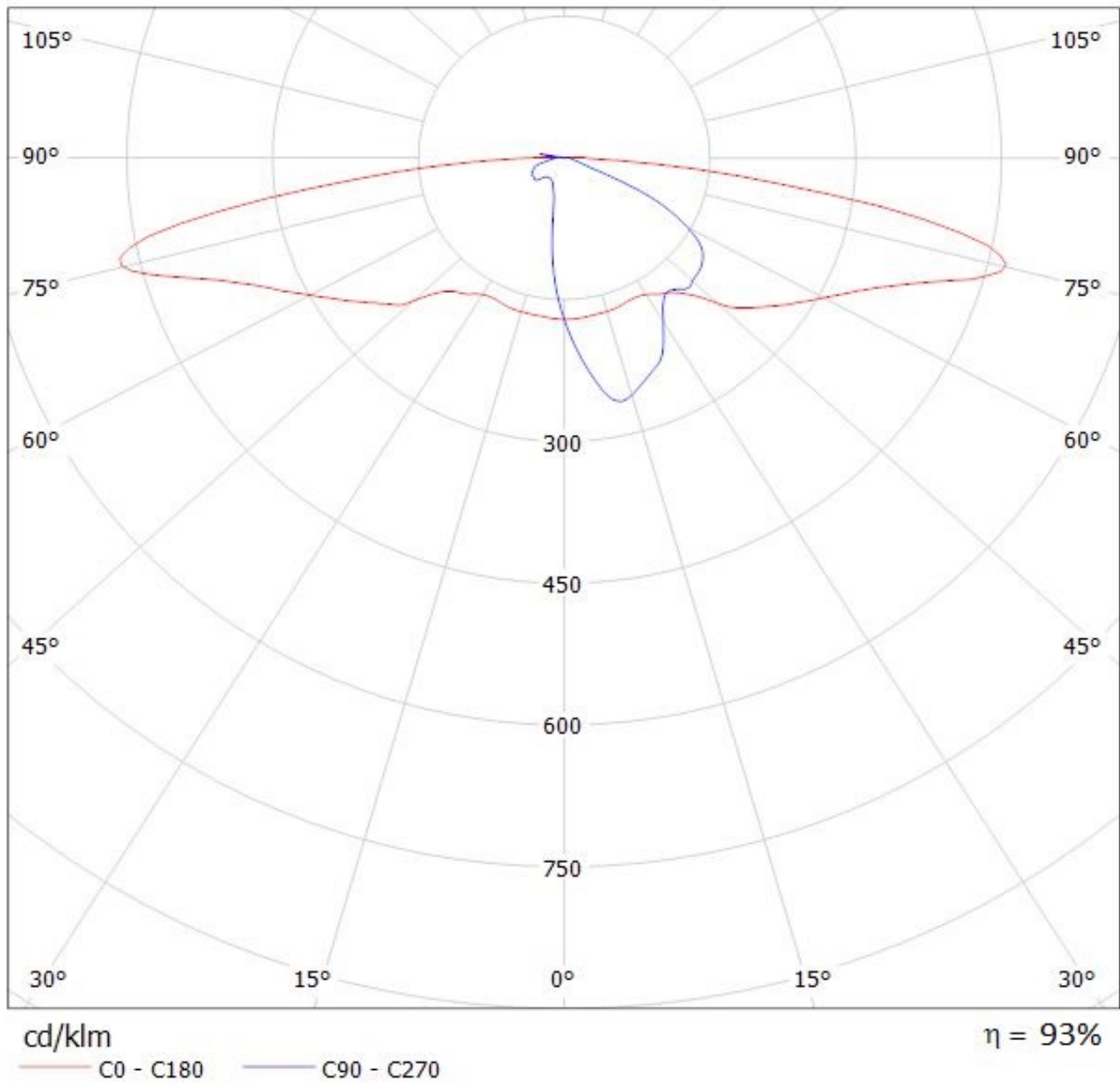

Luminaire: Ledil C15021_STRADA-2X2-SCL_(LH351C)

Lamps: 1 x Samsung_LH351C_518.223lm@250mA_P=2.85225W_I=0.25A

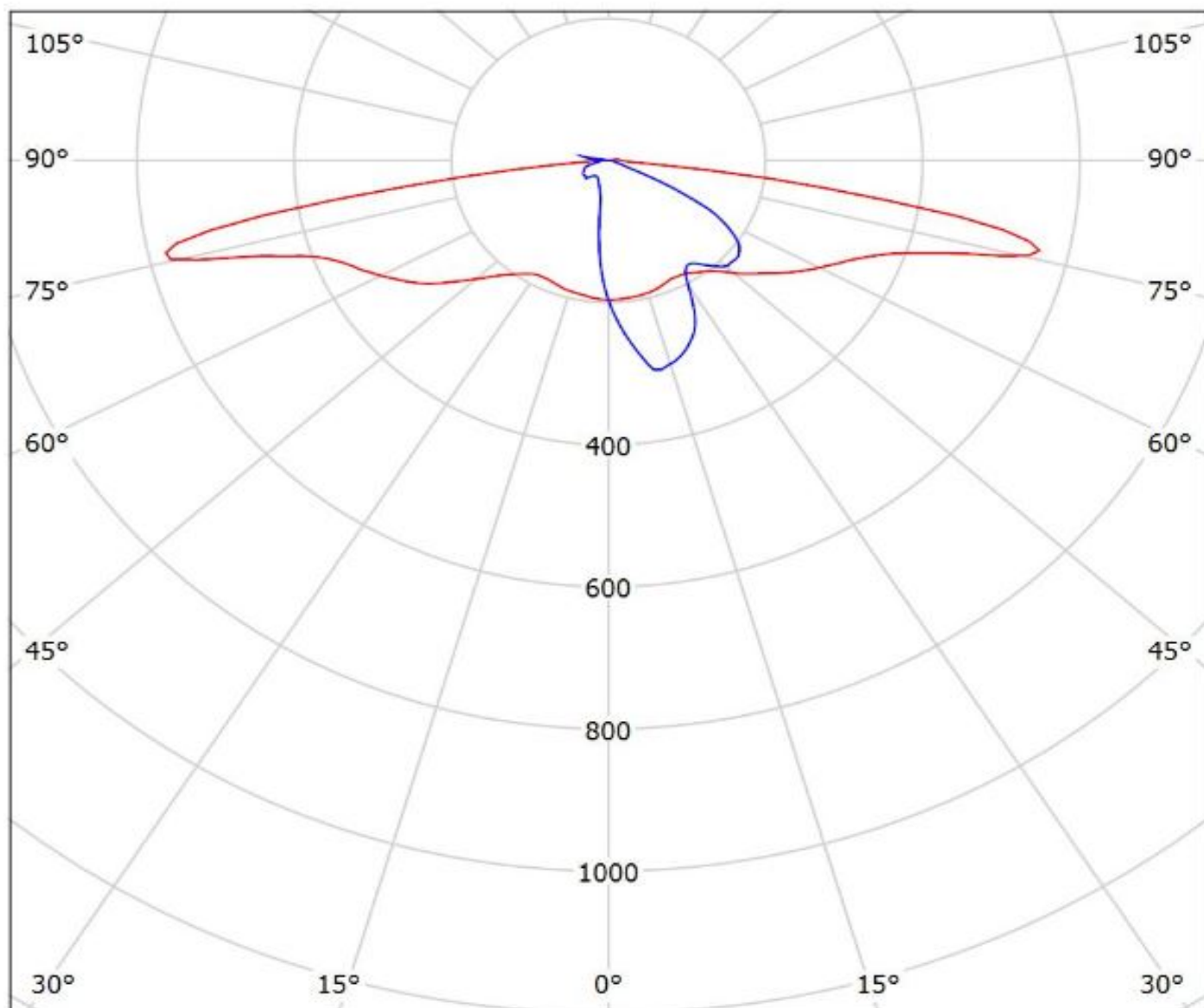

cd/klm

— C0 - C180 — C90 - C270

$\eta = 97\%$

Luminaire: Ledil C15021_STRADA-2X2-SCL_(LH508A)

Lamps: 1 x Samsung_LH508A_2x2_2060.04lm@160mA_CCT=5000K_CRI=80_P=15.5405W_I=0.16A

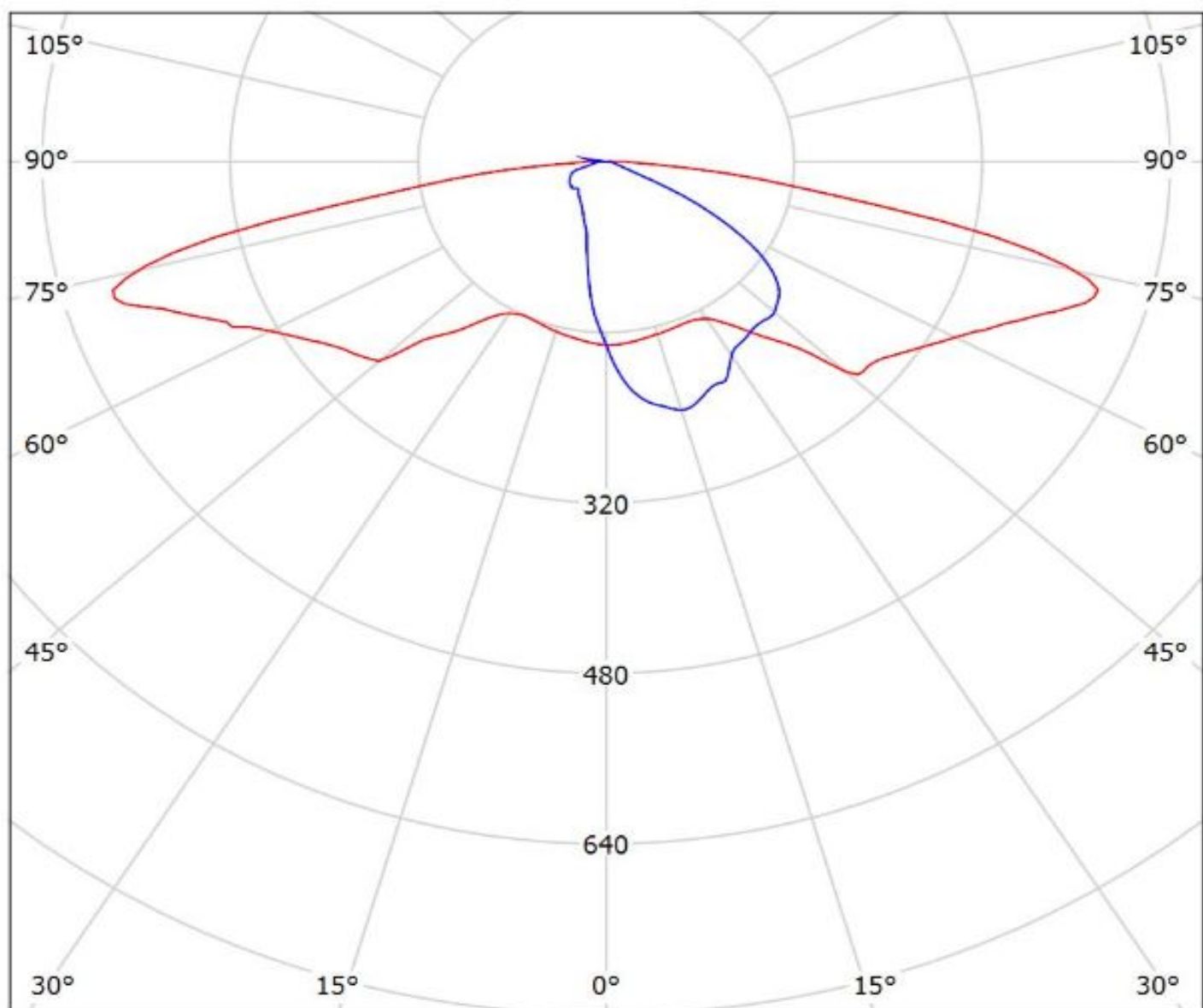

cd/klm

— C0 - C180 — C90 - C270

$\eta = 97\%$

Luminaire: Ledil Oy C15021_STRADA-2X2-SCL_(LH181B)_SIMULATED

Lamps: 1 x Samsung LH181B

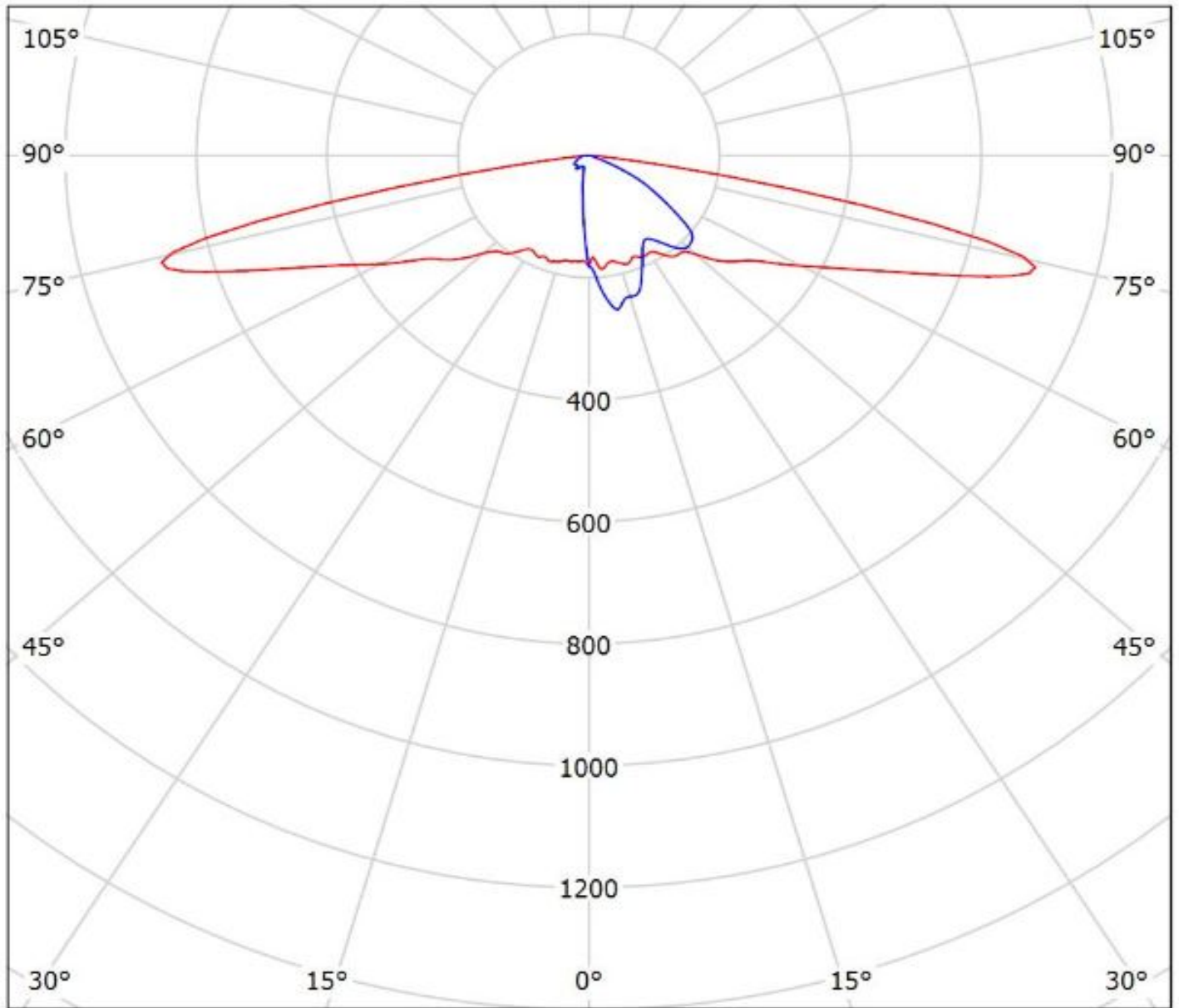

cd/klm

— C0 - C180 — C90 - C270

$\eta = 92\%$

Luminaire: SIMULATED_C15021_STRADA-2X2-SCL_Seoul_Z5M2
Lamps: 1 x

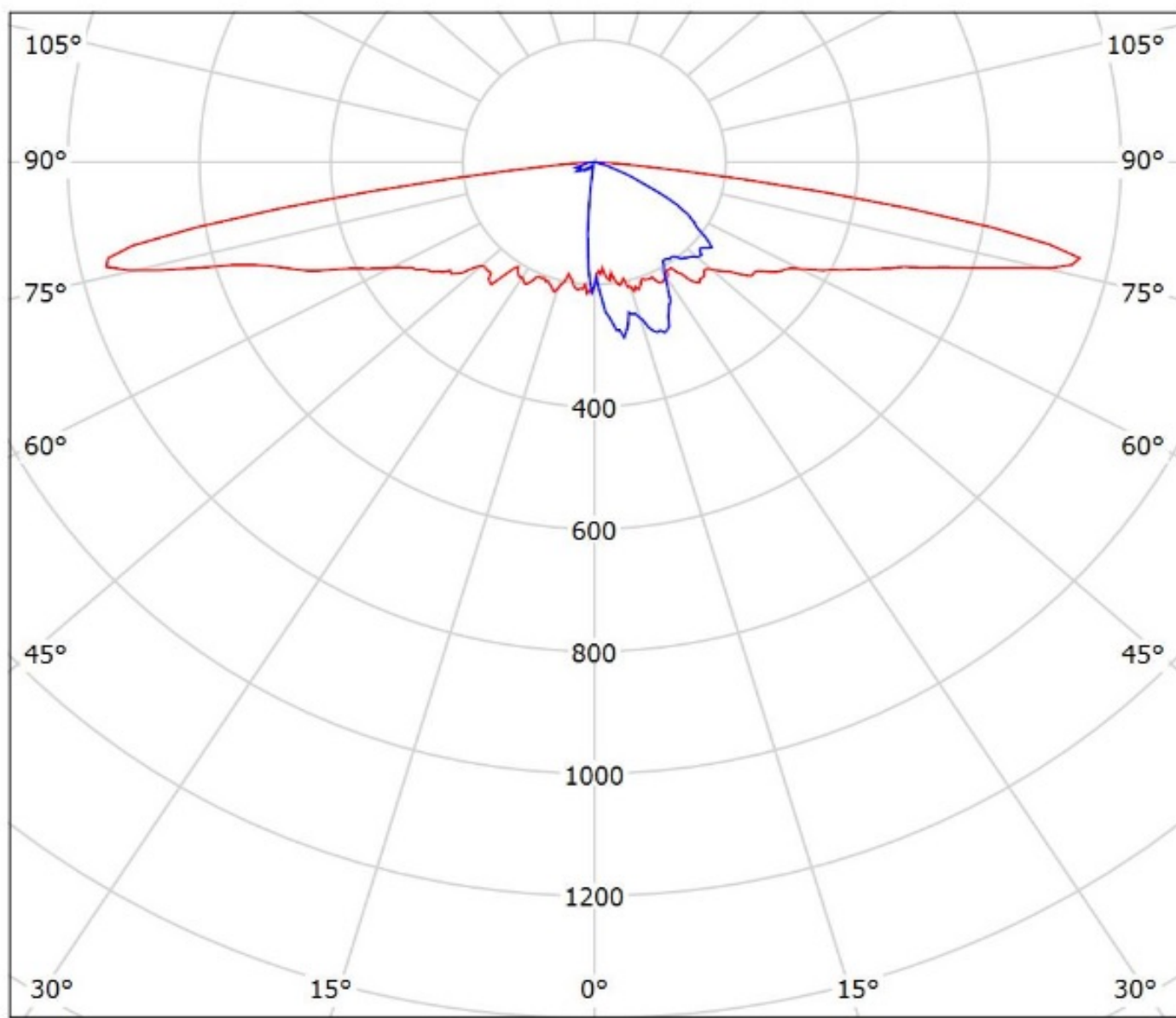

cd/klm

— C0 - C180 — C90 - C270

$\eta = 100\%$

Luminaire: Ledil C15021_STRADA-2X2-SCL (Z8Y22plus)

Lamps: 1 x Seoul_Z8Y22plus_(W6E2G)_513.996lm@250mA_P=2.754W_I=0.250A

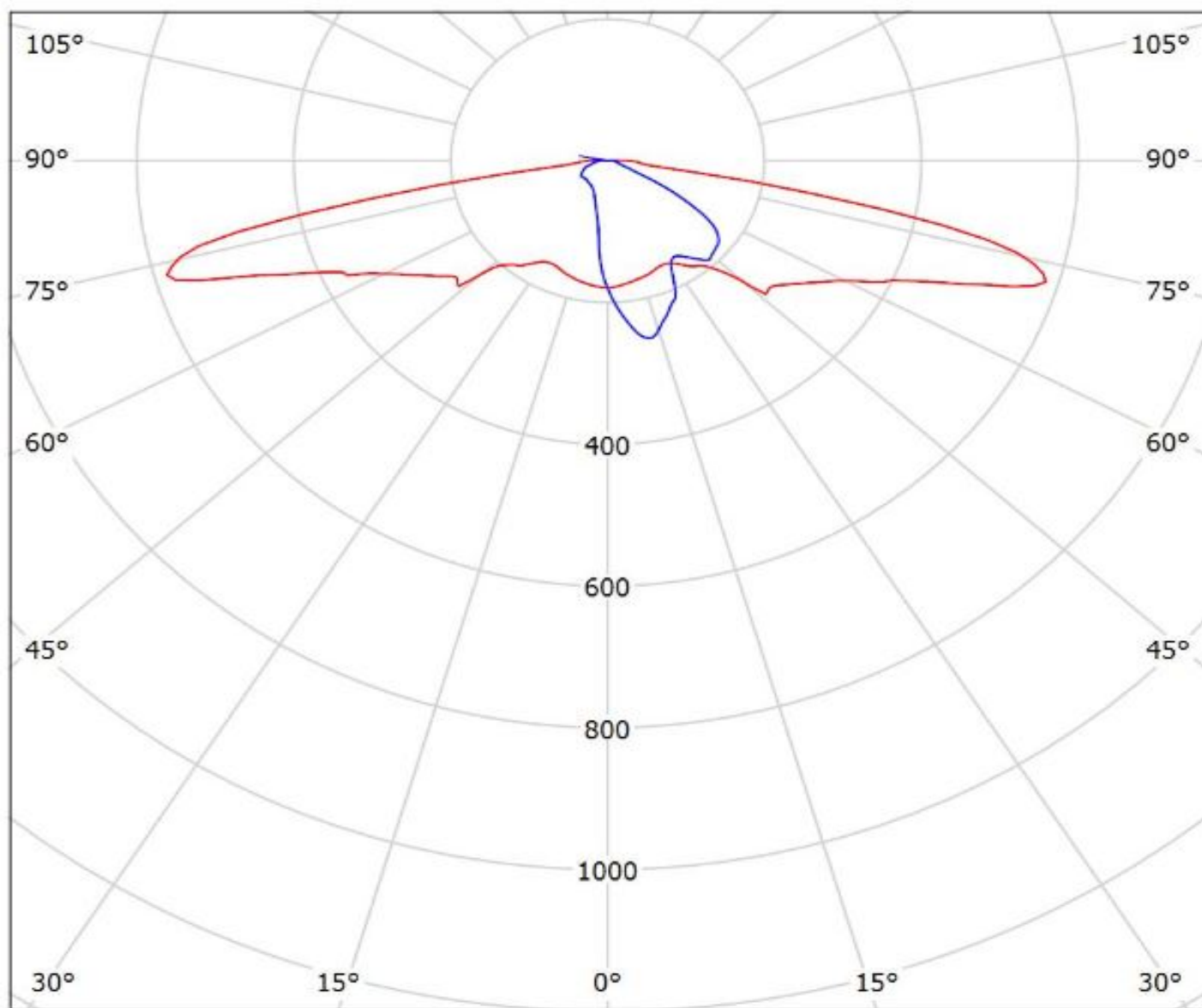

cd/klm

— C0 - C180 — C90 - C270

$\eta = 96\%$

Luminaire: LEDiL Oy C15021_STRADA-2X2-SCL_(Z8Y22)

Lamps: 1 x Seoul_Wicop_Z8Y22_497.373lm@250mA_P=2.80076W_U=11.211V

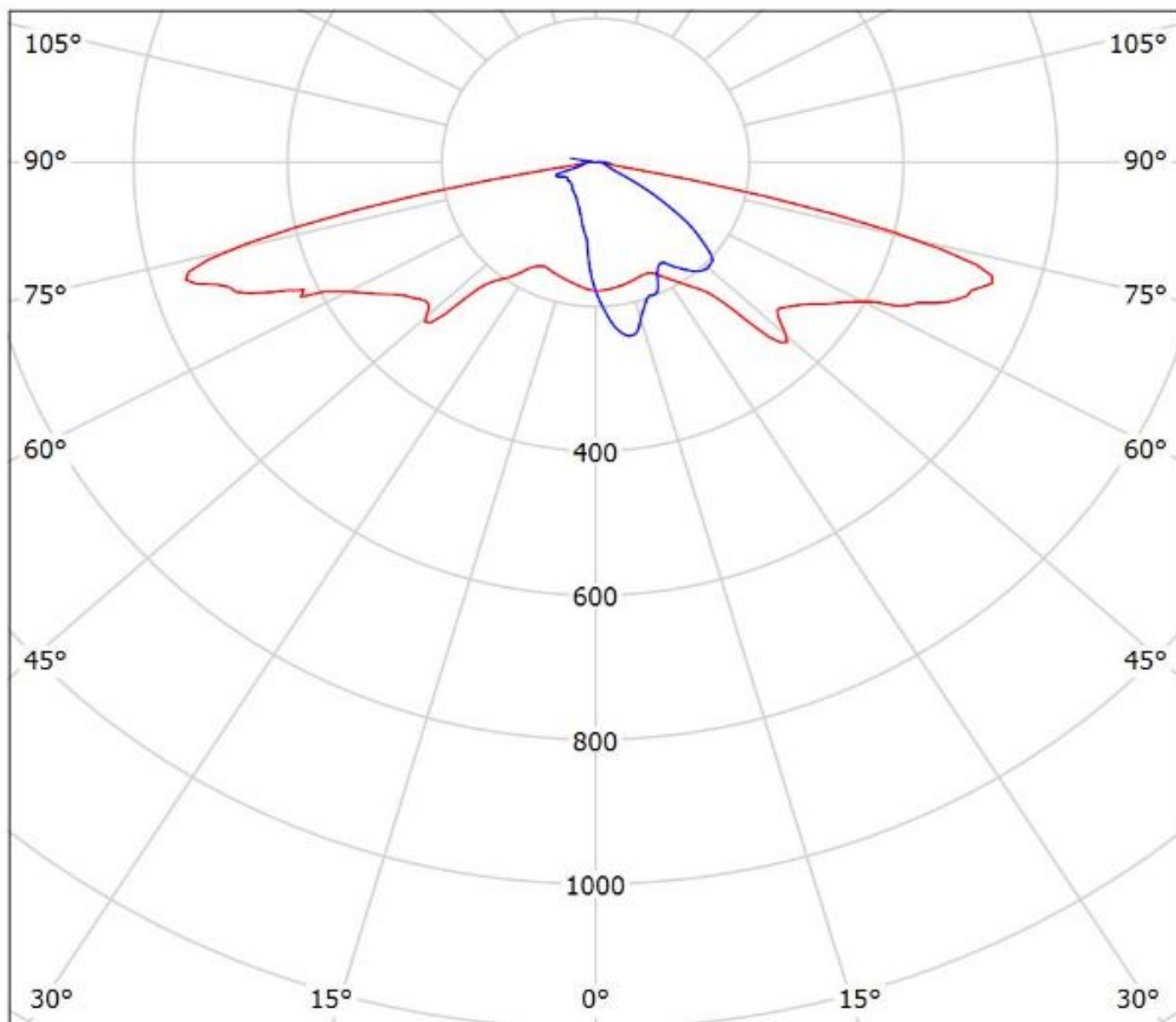

cd/klm

— C0 - C180 — C90 - C270

$\eta = 94\%$

Luminaire: SIMULATED_C15021_STRADA-2X2-SCL_Toshiba_TL1L4

Lamps: 1 x

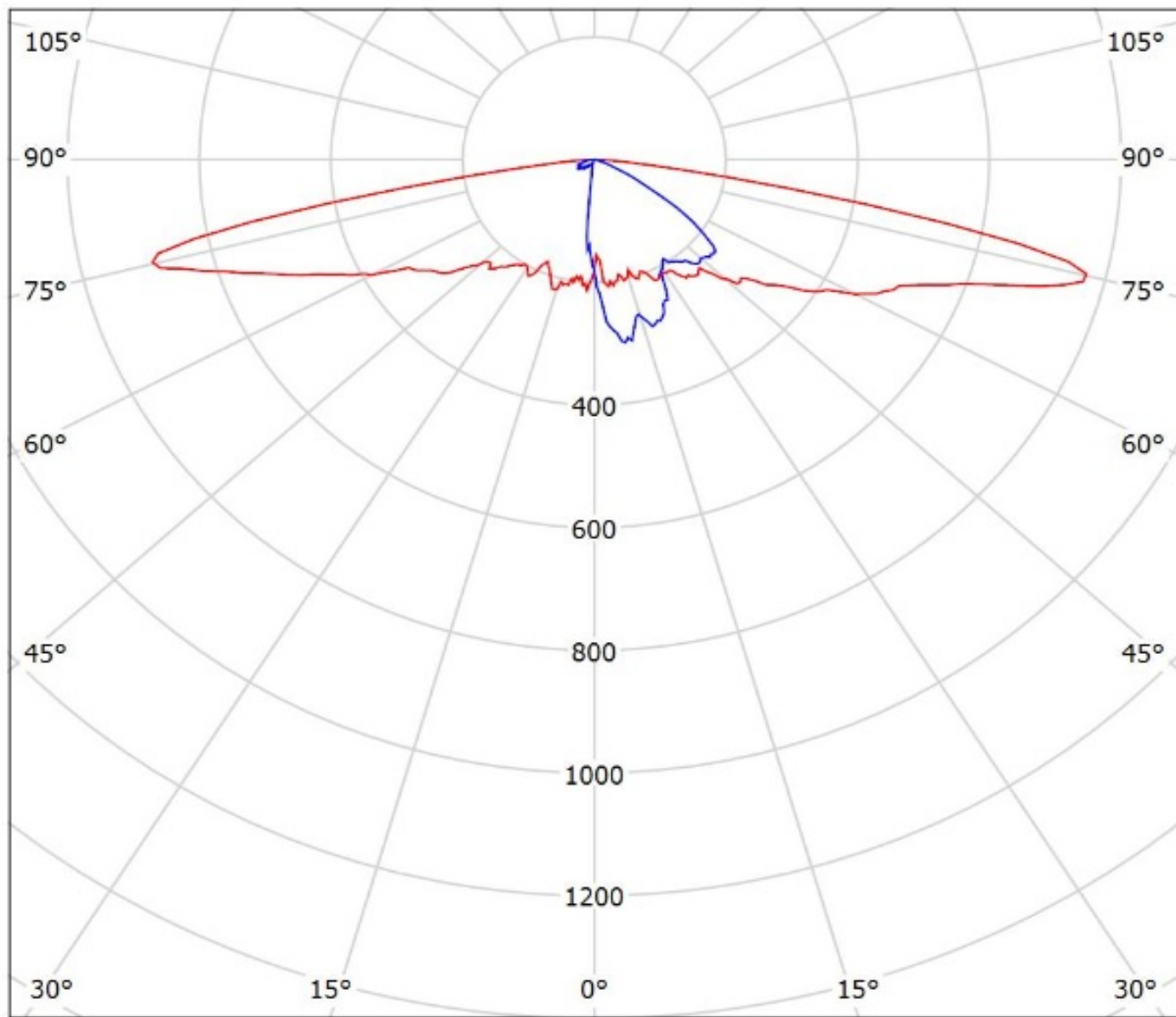

cd/klm

— C0 - C180 — C90 - C270

$\eta = 100\%$

Luminaire: LEDiL Oy C15021_STRADA-2X2-SCL_(Tridonic_Module_RLE_G1)
Lamps: 1 x Tridonic_Module_RLE_G1_4594.42lm@700mA_P=32.1515W_I=0.700A

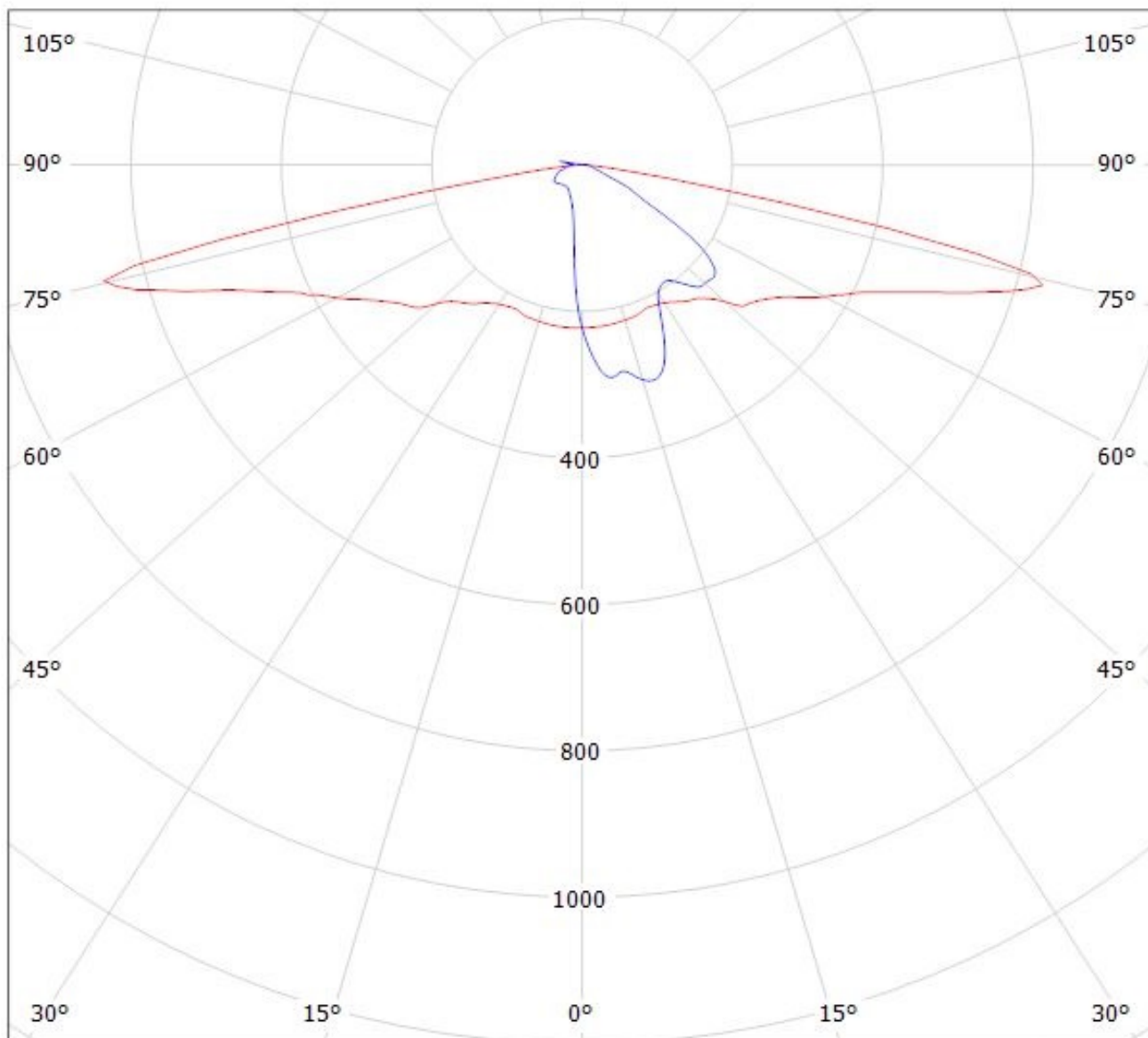

cd/klm

— C0 - C180

— C90 - C270

$\eta = 94\%$

Luminaire: LEDiL Oy C15021_STRADA-2X2-SCL_(Tridonic_Module_RLE_G1)
Lamps: 1 x Tridonic_Module_RLE_G1_4594.42lm@700mA_P=32.1515W_I=0.700A

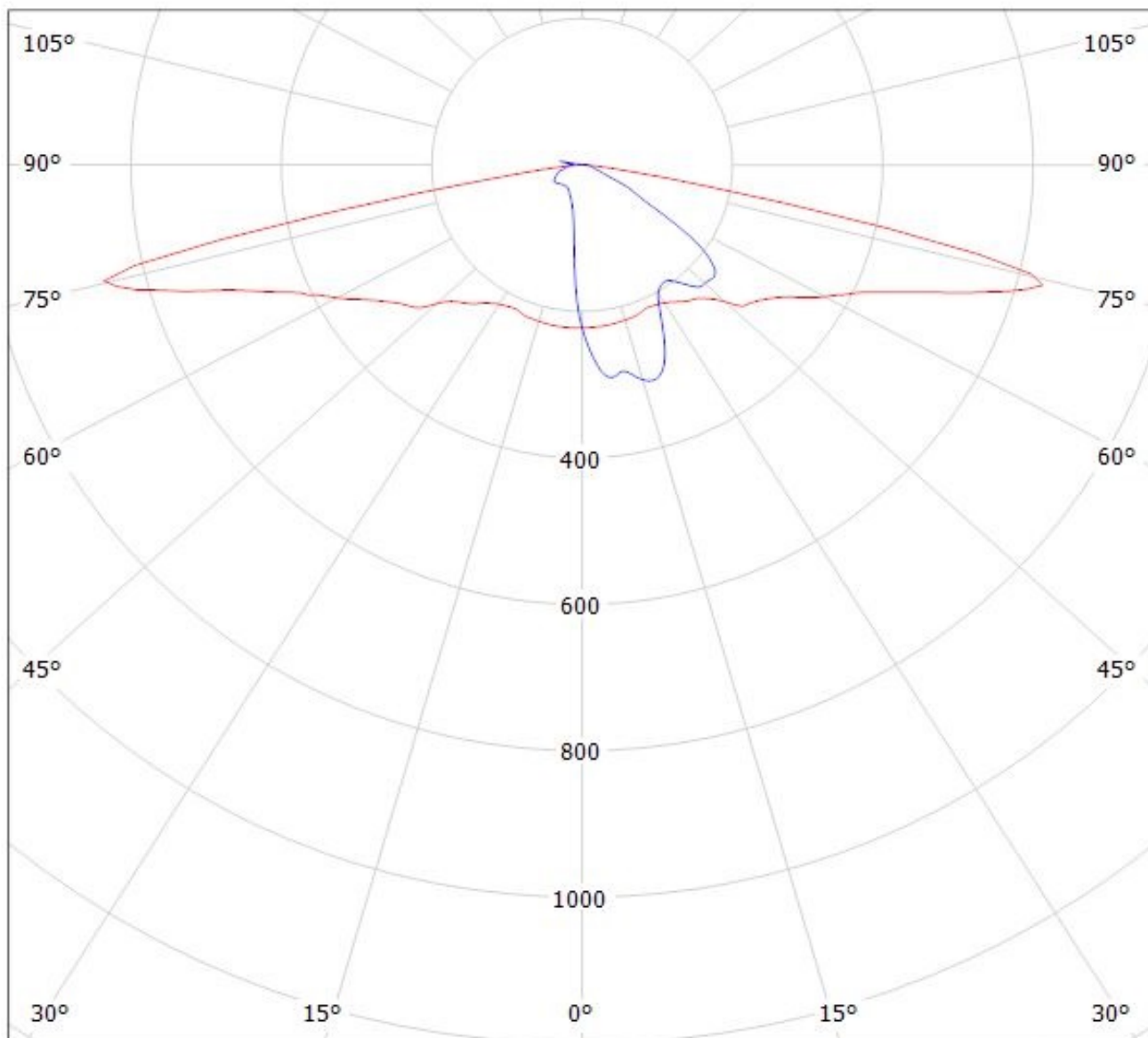

cd/klm

— C0 - C180

— C90 - C270

$\eta = 94\%$

Luminaire: LEDiL Oy C15021_STRADA-2X2-SCL_(Tridonic_Module_RLE_G1)
Lamps: 1 x Tridonic_Module_RLE_G1_2288lm@700mA_P=16W_I=0.700A

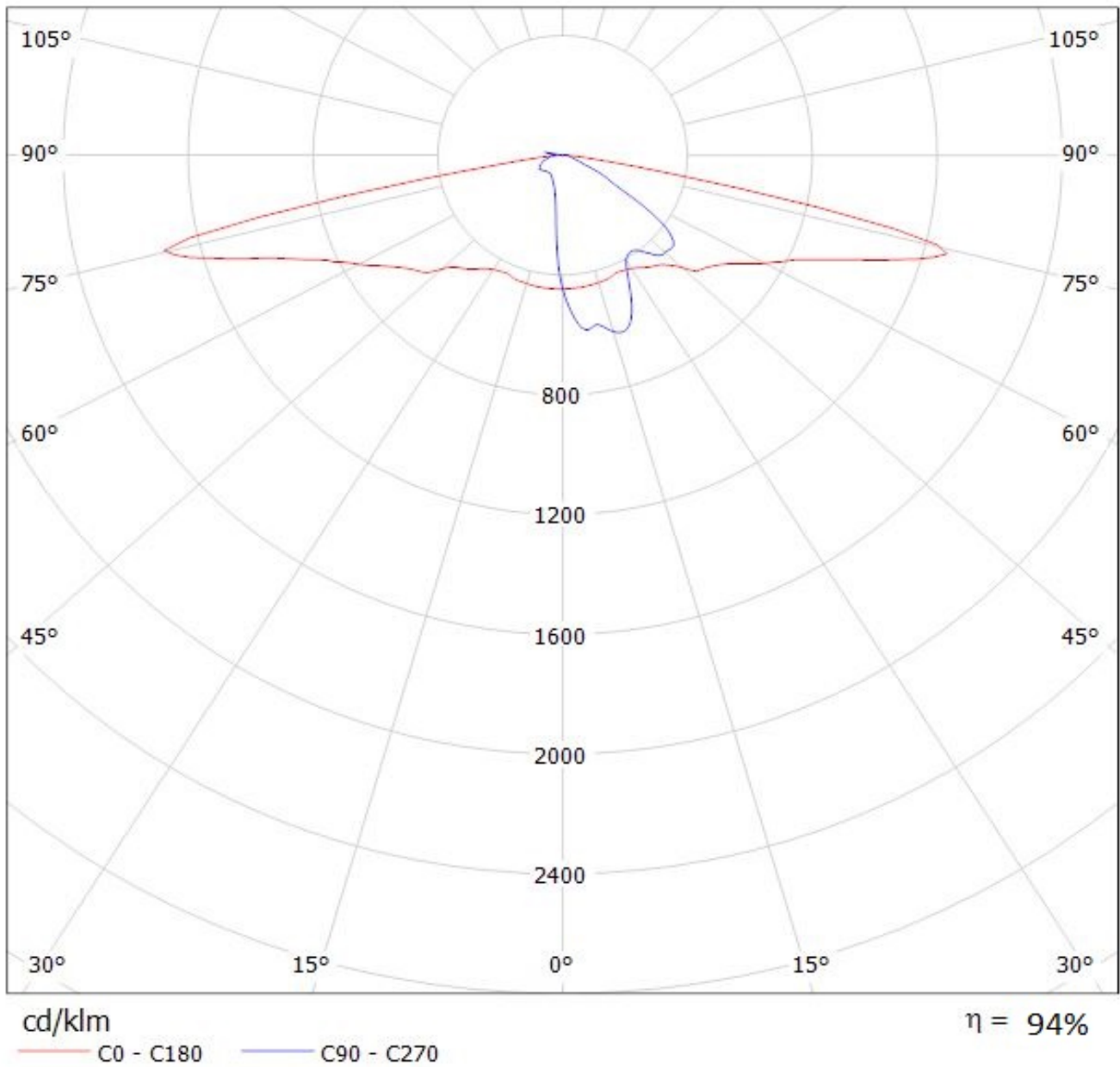

Luminaire: LEDiL Oy C15021_STRADA-2X2-SCL_(Tridonic_Module_RLE_G1)
Lamps: 1 x Tridonic_Module_RLE_G1_2288lm@700mA_P=16W_I=0.700A

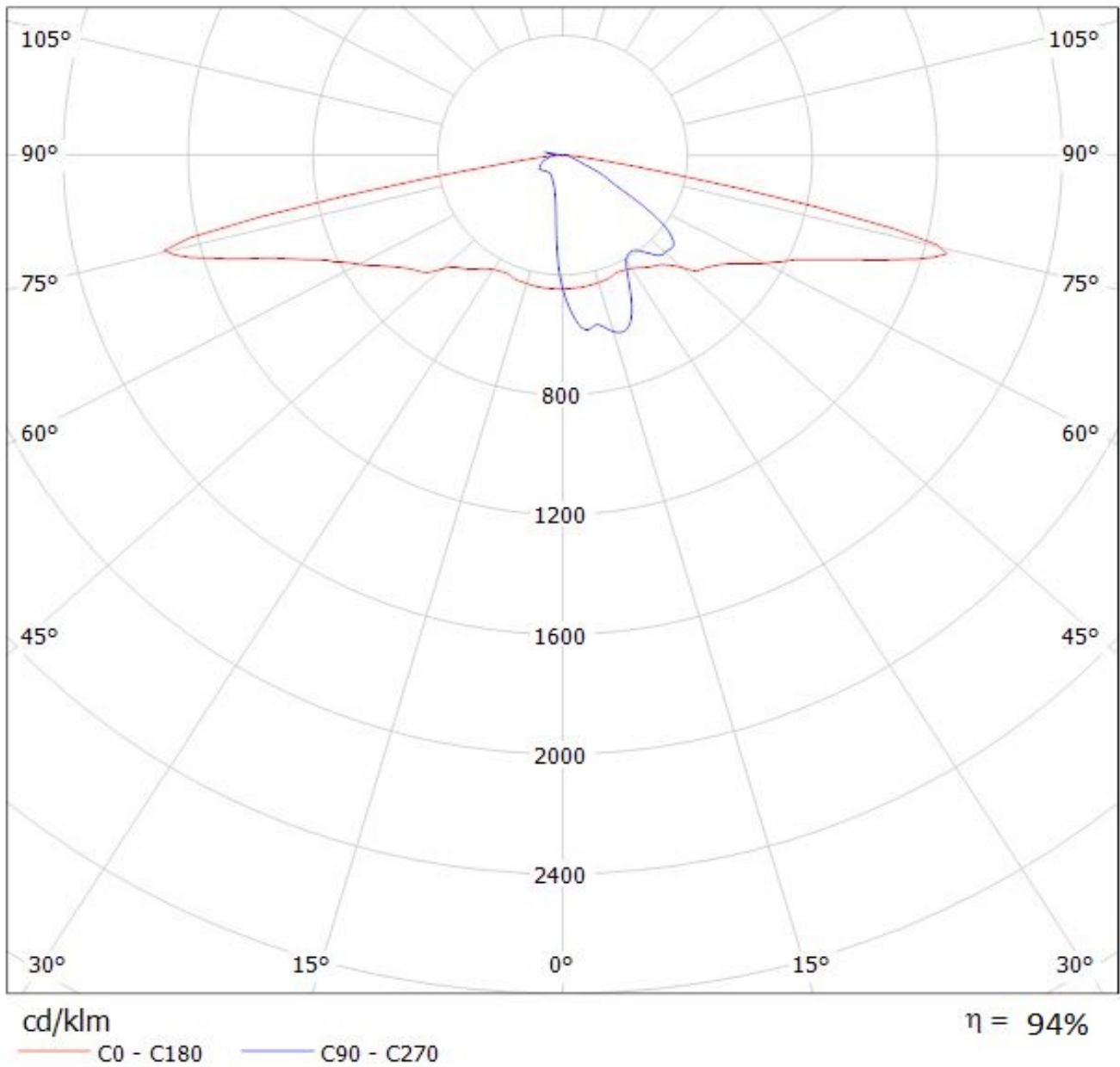

NOTE: The typical divergence will be changed by different color, chip size and chip position tolerance. The typical total divergence is the full angle measured where the luminous intensity is half of the peak value.