

59170 Sub-miniature Overmolded Reed Switch + 57045 Actuator

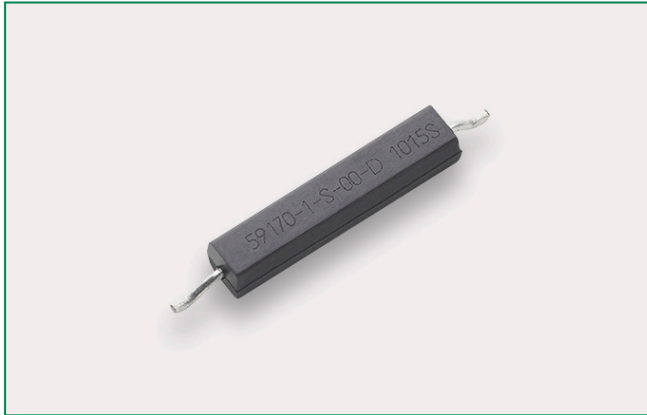

Description

The 59170 is a sub-miniature overmolded reed switch 11.43mm x 2.29mm x 2.29mm (0.450" x 0.090" x 0.090") with either straight or Gull Wing leads. It has normally open contact and capable of switching up to 200Vdc at 10W.

Note: The 57045 Actuator is sold separately.

Features

- Two-part magnetically operated proximity switch
- Gull Wing, leaded
- Tape and reel option
- Solder reflow capable
- Thermoset overmolded material
- RoHS compliant
- Certified for use in North American Hazardous Locations: Class I, Division 2 and Zone 2
- ATEX certified for use in European explosive atmospheres: Ex II 3 G Ex nC IIC Gc

Agency Approvals

Agency	Agency File Number
	E61760 E471070
	DEMKO 14 ATEX 1393U Ex II 3 G Ex nC IIC Gc

Note: Contact Littelfuse for specific agency approval ratings.

Benefits

- Suitable for pick and place
- No standby power requirement
- Operates through non-ferrous materials such as wood, plastic or aluminium
- Hermetically sealed, magnetically operated contacts continue to operate long after optical and other technologies fail due to contamination

Applications

- Position and Limit Sensing
- Security System Switch
- Door Switch

Dimensions

Dimensions in mm (inch)

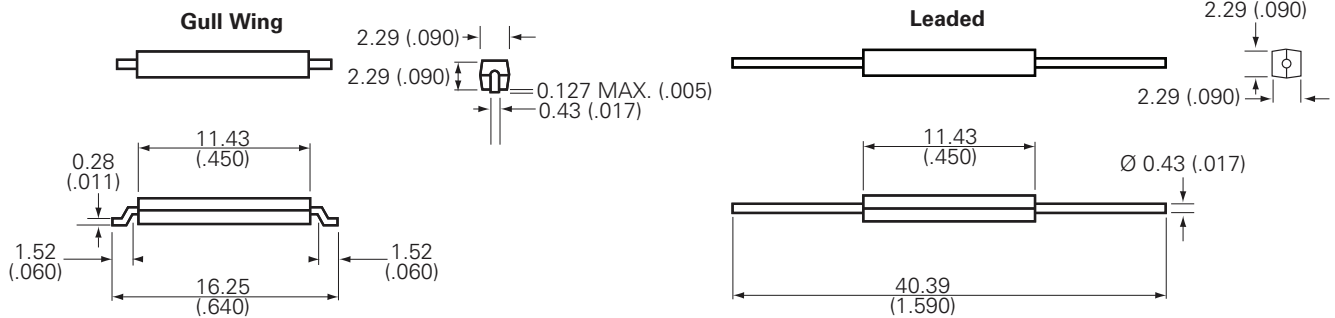

Soldering Footprint

Dimensions in mm (inch)

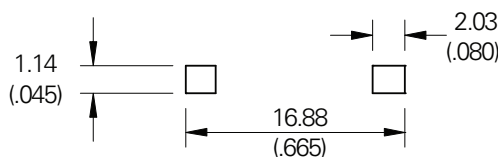

59170 Sub-miniature Overmolded Reed Switch + 57045 Actuator

Electrical Ratings

Contact Type			Normally Open
Switch Type			1
Contact Rating ¹		VA/Watt - max.	10
Voltage ³	Switching ²	Vdc - max.	200
	Breakdown ⁴	Vac - max.	140
		Vdc - min.	250
Current ³	Switching ²	Adc - max.	0.5
		Aac - max.	0.35
	Carry	Adc - max.	0.8
Resistance	Contact, Initial Insulation	Ω - max. Ω - min.	0.1 10 ¹⁰
Capacitance	Contact	pF - typ.	0.3
Temperature	Operating	°C	-40 to +125

Product Characteristics

Operate Time ⁵		ms - max.	1.0
Release Time ⁵		ms - max.	0.5
Shock ⁶	11ms ½ sine	G - max.	100
Vibration ⁶	50-2000 Hz	G - max.	30

Notes:

- Contact rating - Product of the switching voltage and current should never exceed the wattage rating. Contact Littelfuse for additional load/life information.
- When switching inductive and/or capacitive loads, the effects of transient voltages and/or currents should be considered. Refer to Application Notes AN108A and AN107 for details.
- Electrical Load Life Expectancy - Contact Littelfuse with voltage, current values along with type of load.
- Breakdown Voltage - per MIL-STD-202, Method 301.
- Operate (including bounce)/Release Time - per EIA/NARM RS-421-A, diode suppressed coil (Coil II).
- Shock and Vibration - per EIA/NARM RS-421-A and MIL-STD-202.

Sensitivity Options (Using 57045 Actuator)

Select Option		S		T		U	
Switch Type		Pull-In AT Range	Activate Distance, D mm (inch) Average	Pull-In AT Range	Activate Distance, D mm (inch) Average	Pull-In AT Range	Activate Distance, D mm (inch) Average
1	Normally Open	10-15	6.5 (.255)	15-20	5.0 (.197)	20-25	4.6 (.181)

Note:

- Pull-In AT Range: These AT values are the before molding and modification AT of the 59170.
- The activation distance is average value post modification for the Gull wing option C or D.

Termination Specification

Termination Options	
Select Option	Description
A	Leaded
C	Gull Wing bulk packed
D	Gull Wing tape and reel

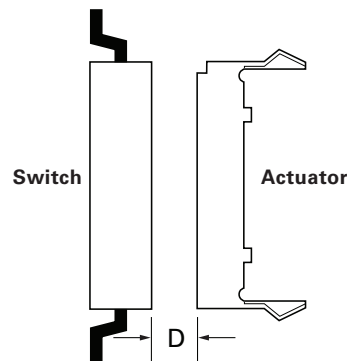

59170 Sub-miniature Overmolded Reed Switch + 57045 Actuator

Part Numbering System

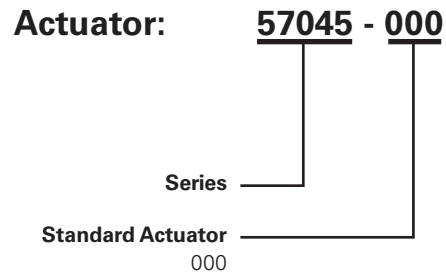
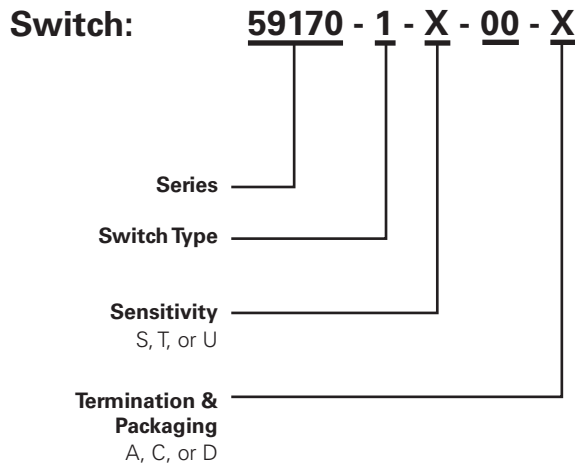

Note: The 57045 Actuator is sold separately.

Product Marking

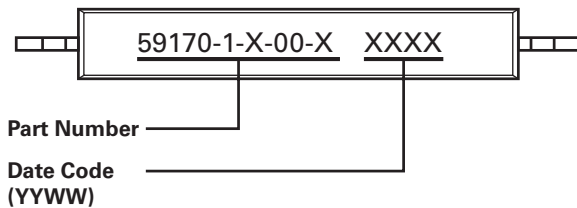

Packaging

Packaging Option	Packaging Specification	Quantity	Termination and Packaging Code	Taping Width
Bulk	Bulk	59170-1-X-00-A 800/box	A	N/A
Bulk	Bulk	59170-1-X-00-C 1500/box	C	N/A
Tape and Reel	EIA-RS-481-1	1500	D	32.00mm (1.260")