2.4 GHz / 5.5 GHz Waterproof Dipole 2 dBi Antenna, IP67



ORDERING INFORMATION

| Order Number | Description |
|-----------------|--|
| 001-0012 | 2.4/5.5 GHz Waterproof Dipole Antenna for Reverse Polarity SMA Connector, IP67 |
| 080-0013 | U.FL to Reverse Polarity SMA Cable, 105mm, O-Ring Seal |
| 080-0014 | U.FL to Reverse Polarity SMA Cable, 210mm, O-Ring Seal |

Table 1 Orderable Part Numbers

SPECIFICATIONS

| Specification | Value |
|-------------------|--------------------------------|
| 2.4 Ghz Band Gain | +2 dBi |
| 5 GHz Band Gain | +2 dBi |
| Impedance | 50 ohms |
| Type | Dipole |
| Polarization | Linear Vertical |
| VSWR | ≤2.5 : 1 |
| Frequency | 2400 - 2500MHz, 4910 - 5850MHz |
| Weight | 18g |
| Size | 114 mm x 13 mm |
| Antenna Color | Black |
| Operating Temp | -40°C to +85°C |
| UL Rating | UL 94HB |

Table 2 Specifications

The information in this document is subject to change without notice.

PHYSICAL DIMENSIONS (MM)

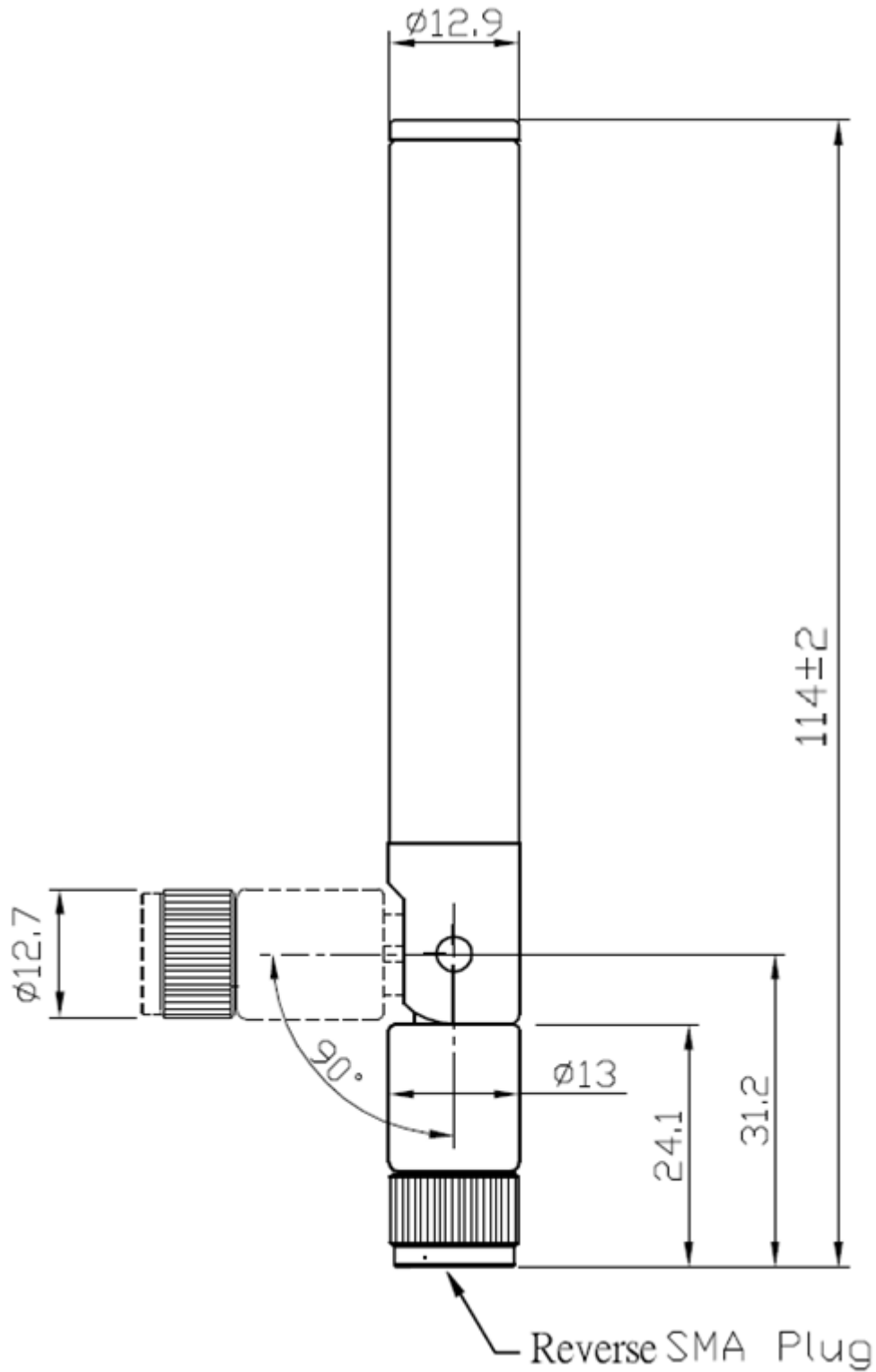

Figure 1 Physical Dimensions

TYPICAL ANTENNA REFLECTION PERFORMANCE

Straight Antenna Position

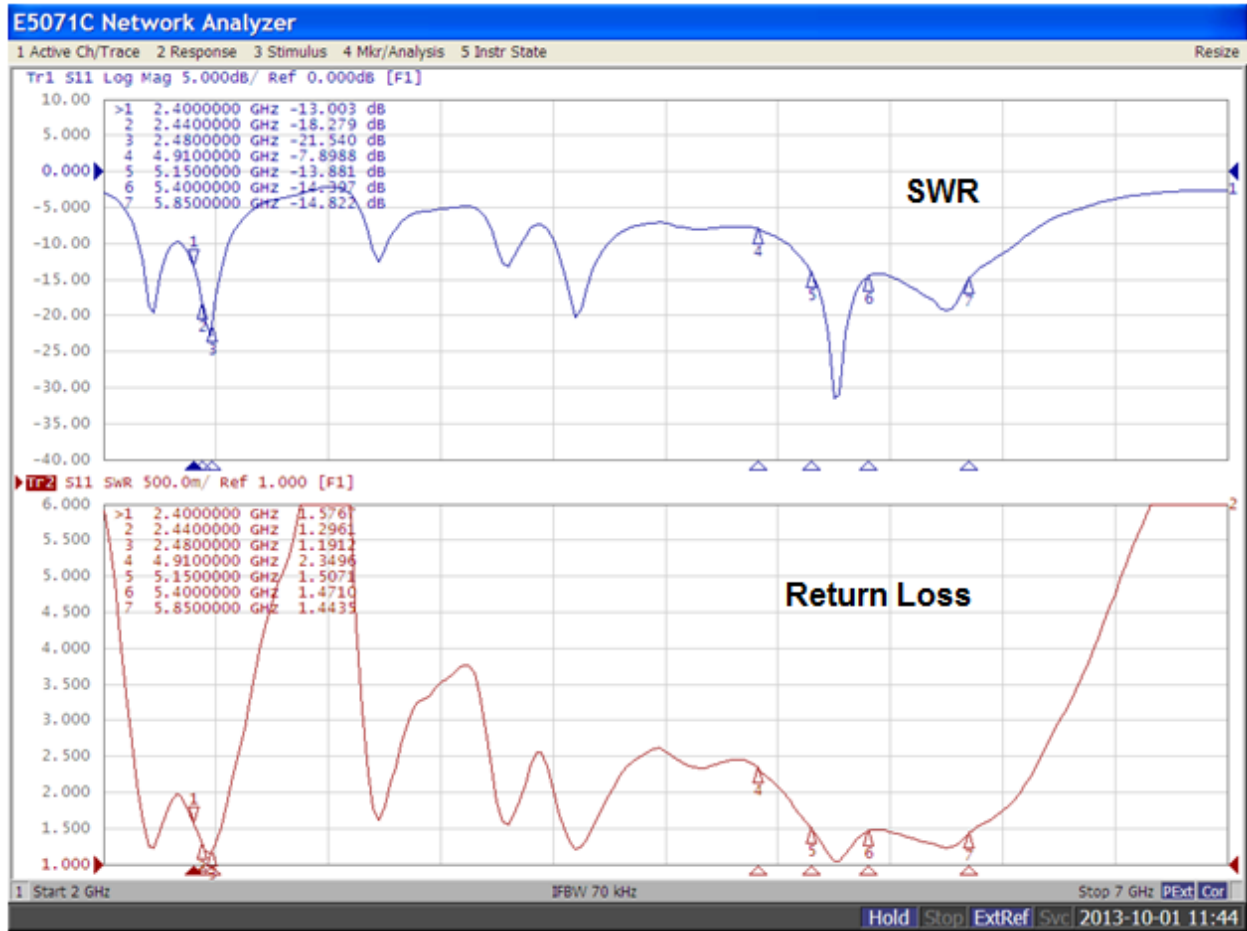

Figure 2 Typical Straight Position Reflection Performance

Bent Antenna Position

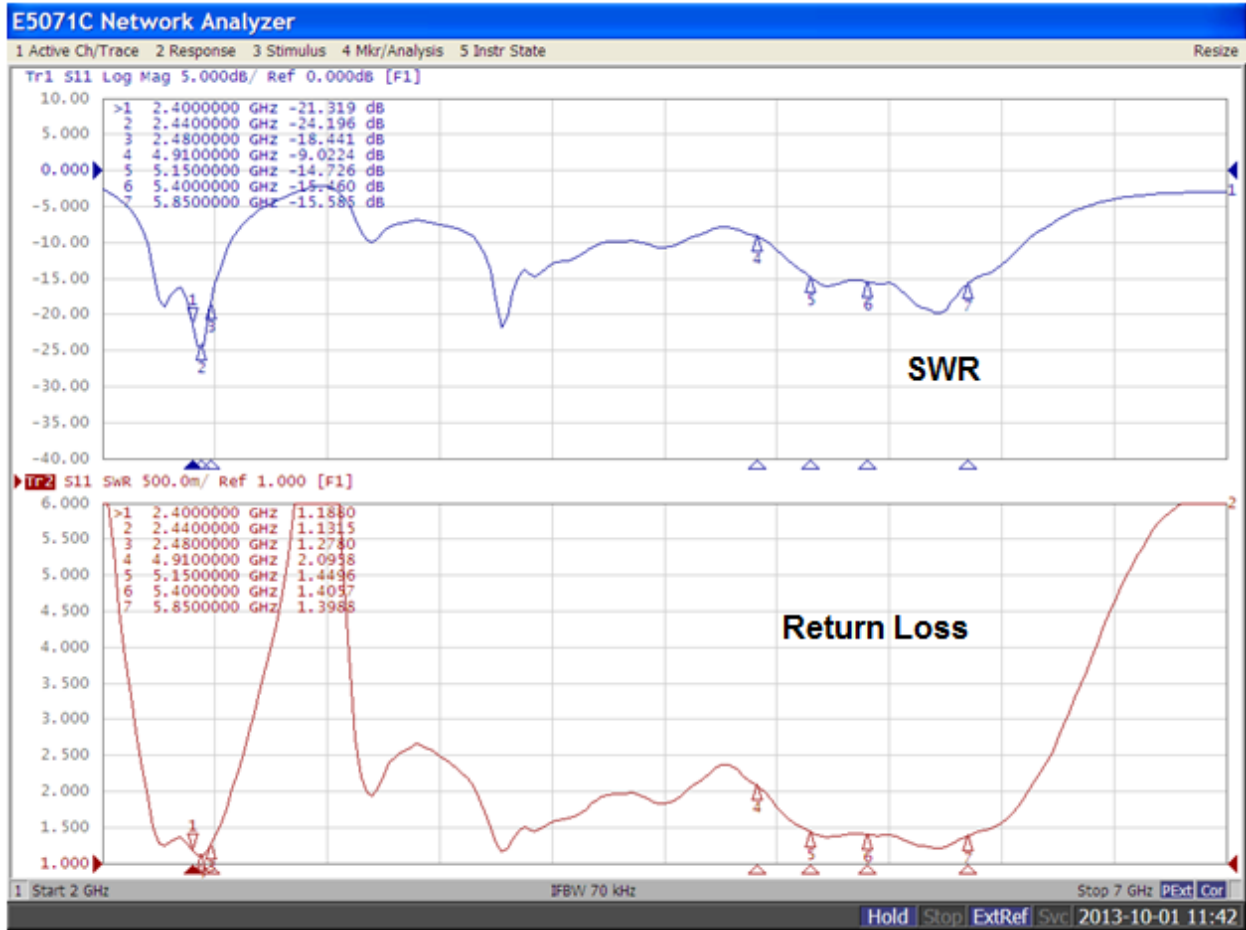

Figure 3 Typical Bent Position Reflection Performance

TYPICAL ANTENNA RADIATION PERFORMANCE

2.4 GHz Band

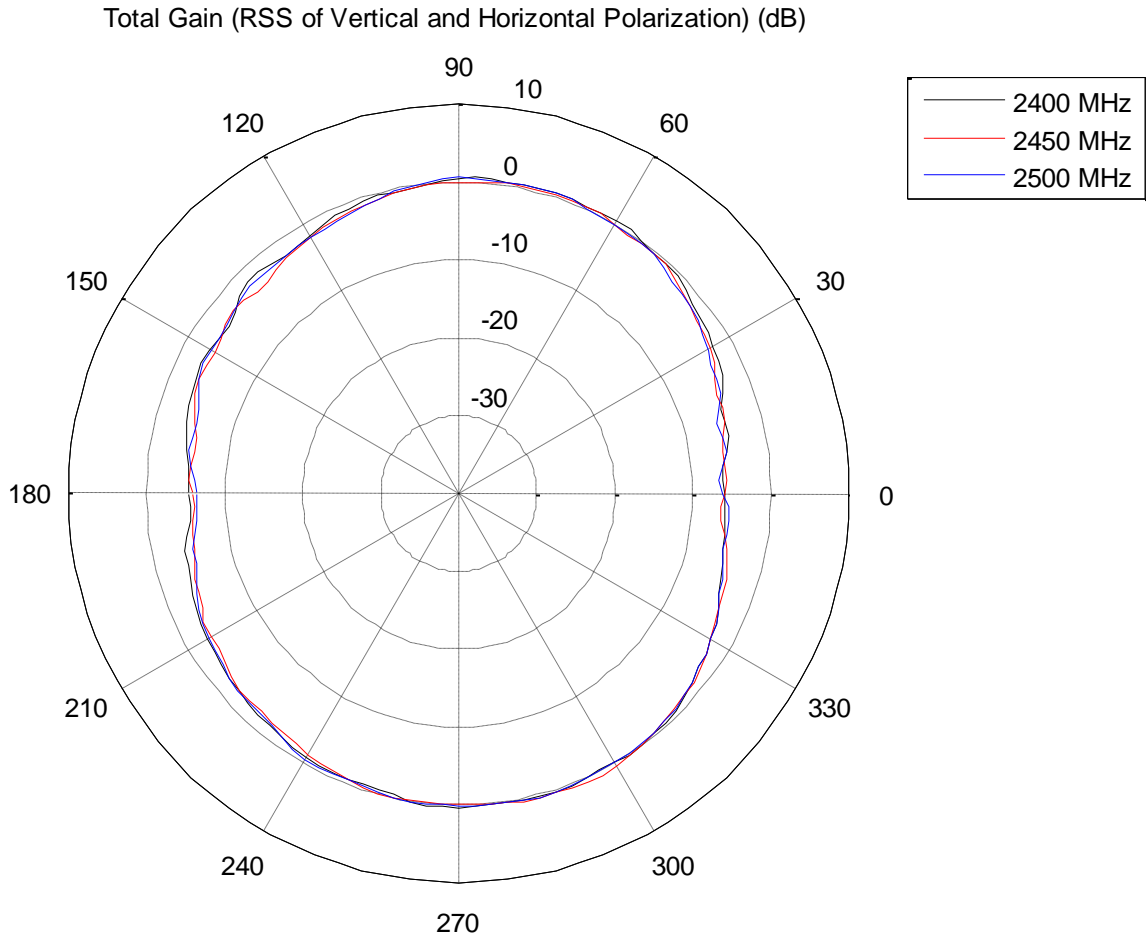

Figure 4 Typical E-Plane Performance

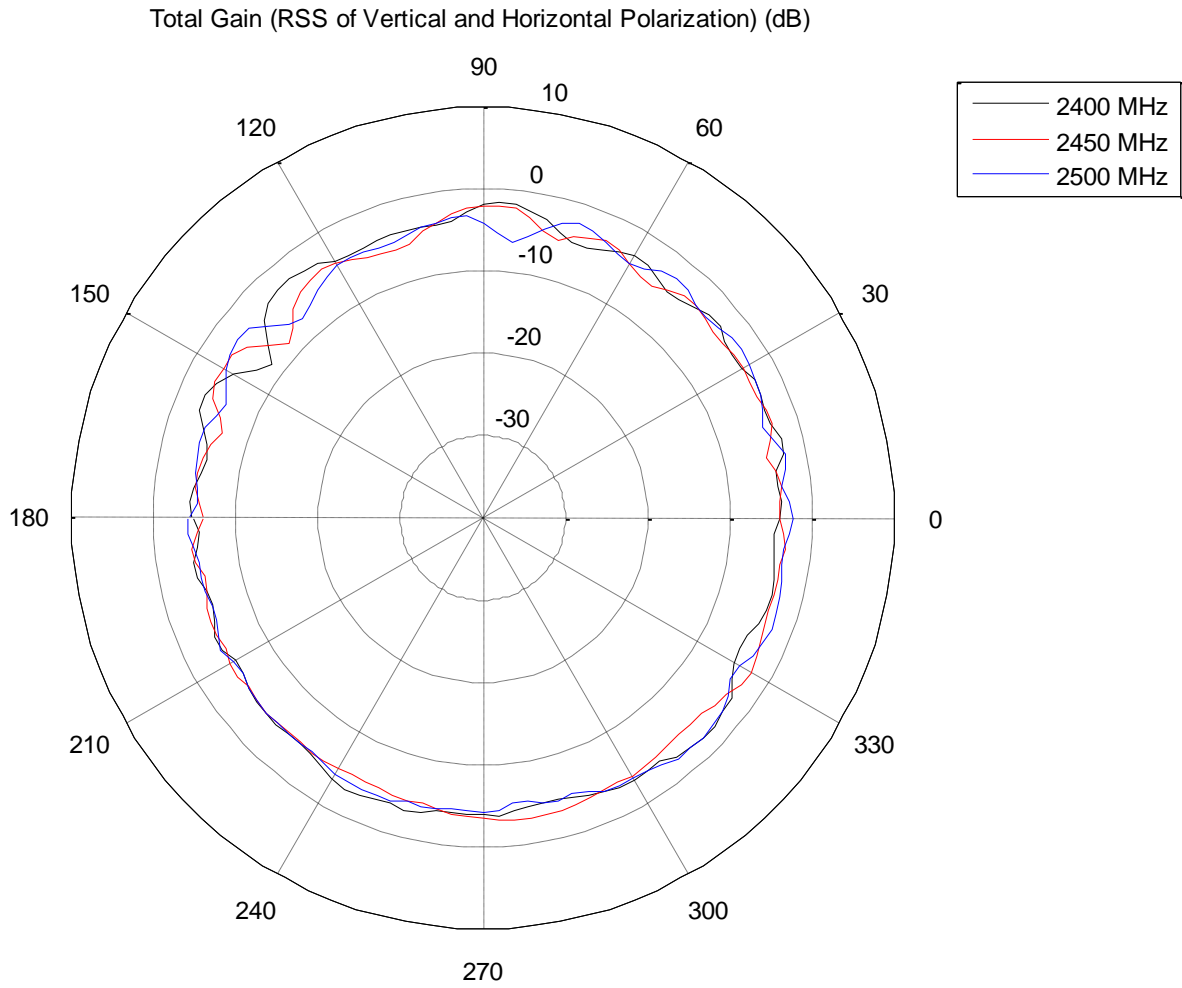

Figure 5 Typical H-Plane Performance

5 GHz Band

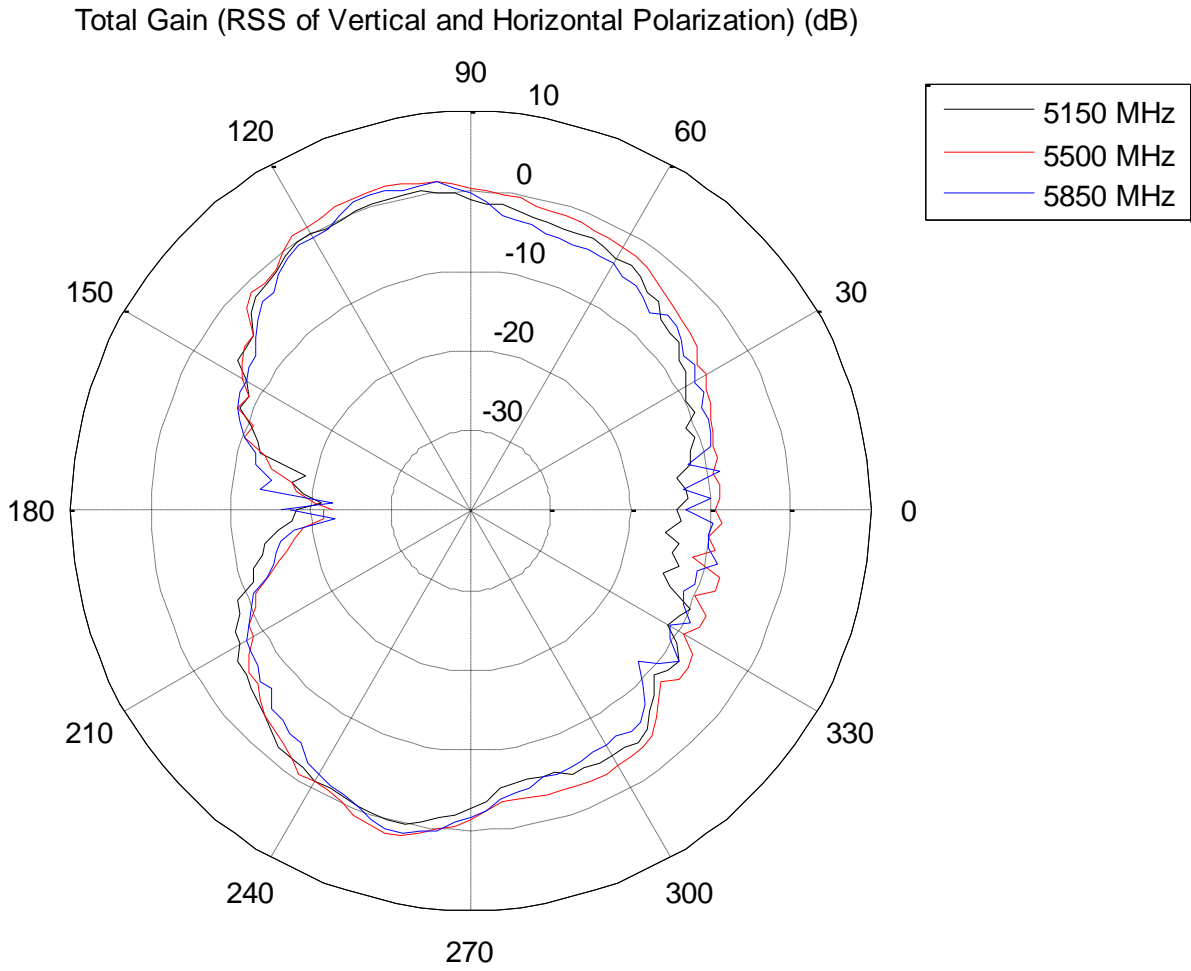

Figure 6 Typical E-Plane Performance

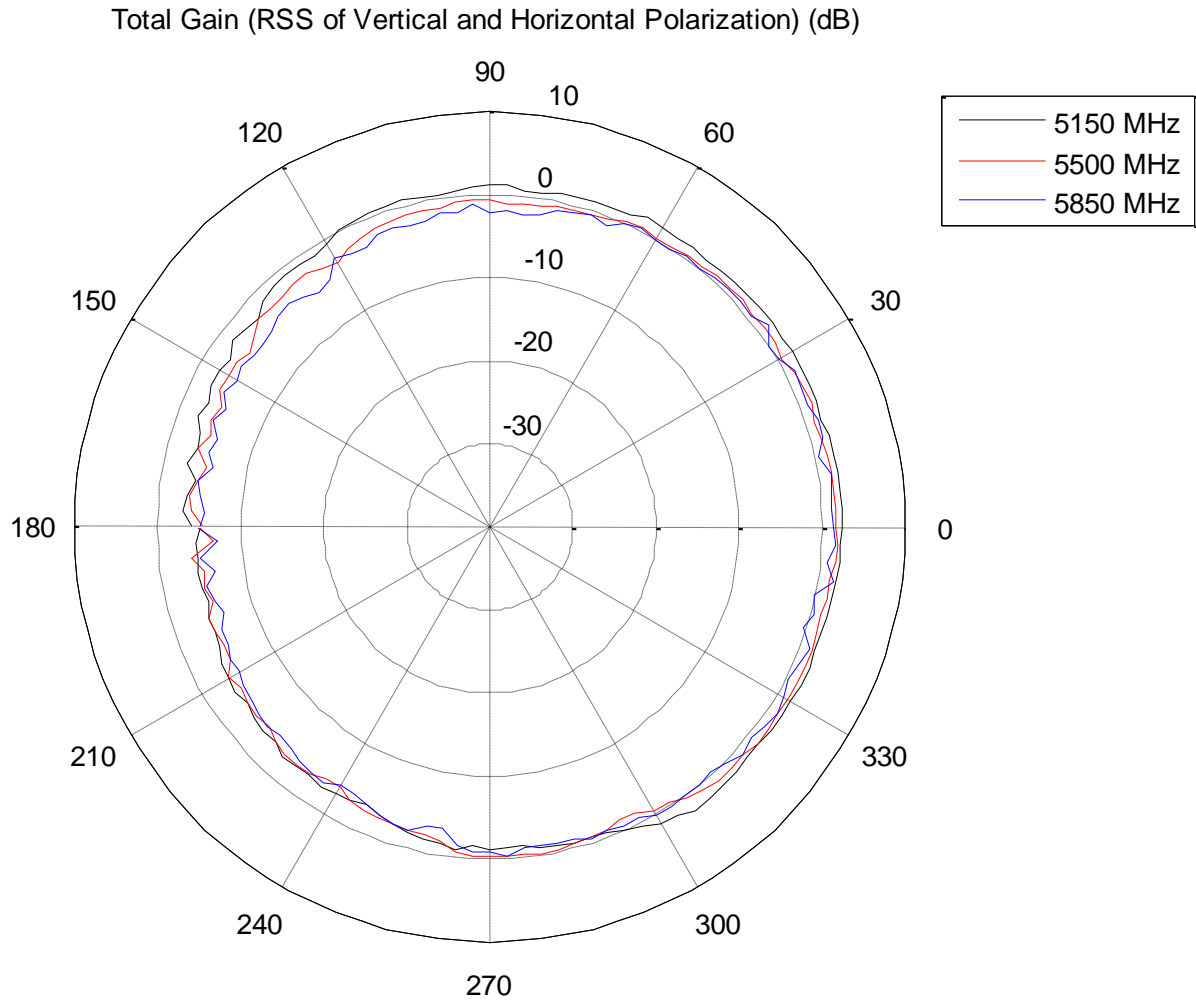

Figure 7 Typical H-Plane Performance

CONTACTING LS RESEARCH

| | |
|--------------------------|--|
| Headquarters | LS Research, LLC W66 N220 Commerce Court Cedarburg, WI 53012-2636 USA Tel: 1(262) 375-4400 Fax: 1(262) 375-4248 |
| Website | www.lsr.com |
| Wiki | www.lsr.com/products-wiki |
| Technical Support | www.lsr.com/products-forum |
| Sales Contact | sales@lsr.com |

The information in this document is provided in connection with LS Research (hereafter referred to as "LSR") products. No license, express or implied, by estoppel or otherwise, to any intellectual property right is granted by this document or in connection with the sale of LSR products. EXCEPT AS SET FORTH IN LSR'S TERMS AND CONDITIONS OF SALE LOCATED ON LSR'S WEB SITE, LSR ASSUMES NO LIABILITY WHATSOEVER AND DISCLAIMS ANY EXPRESS, IMPLIED OR STATUTORY WARRANTY RELATING TO ITS PRODUCTS INCLUDING, BUT NOT LIMITED TO, THE IMPLIED WARRANTY OF MERCHANTABILITY, FITNESS FOR A PARTICULAR PURPOSE, OR NON-INFRINGEMENT. IN NO EVENT SHALL LSR BE LIABLE FOR ANY DIRECT, INDIRECT, CONSEQUENTIAL, PUNITIVE, SPECIAL OR INCIDENTAL DAMAGES (INCLUDING, WITHOUT LIMITATION, DAMAGES FOR LOSS OF PROFITS, BUSINESS INTERRUPTION, OR LOSS OF INFORMATION) ARISING OUT OF THE USE OR INABILITY TO USE THIS DOCUMENT, EVEN IF LSR HAS BEEN ADVISED OF THE POSSIBILITY OF SUCH DAMAGES. LSR makes no representations or warranties with respect to the accuracy or completeness of the contents of this document and reserves the right to make changes to specifications and product descriptions at any time without notice. LSR does not make any commitment to update the information contained herein. Unless specifically provided otherwise, LSR products are not suitable for, and shall not be used in, automotive applications. LSR's products are not intended, authorized, or warranted for use as components in applications intended to support or sustain life.

The information in this document is subject to change without notice.