



■ Features

- Three-Phase 340 ~ 550VAC wide range input (Dual phase operation possible)
- Width only 85.5mm
- Built-in active PFC function compliance to EN61000-3-2
- High efficiency 93% and low power dissipation
- Protections: Short circuit / Overload / Over voltage / Over temperature
- Cooling by free air convection
- Built-in constant current limiting circuit
- Can be installed on DIN rail TS-35/7.5 or 15
- UL508(industrial control equipment)approved
- EN61000-6-2(EN50082-2) industrial immunity level
- Optional DC OK relay contact
- 3 years warranty

■ Applications

- Industrial control system
- Semiconductor fabrication equipment
- Factory automation
- Electro-mechanical apparatus

■ Description

TDR-480 is one economical slim 480W DIN rail power supply series, adapt to be installed on TS-35/7.5 or TS-35/15 mounting rails. The body is designed 85.5mm in width, which allows space saving inside the cabinets. The entire series adopts the full range AC input from 3 ψ 340VAC to 550VAC (Dual Phase operation possible) and conforms to EN61000-3-2, the norm the European Union regulates for harmonic current. TDR-480 is designed with metal housing that enhances the unit's power dissipation. With working efficiency up to 93 %, the entire series can operate at the ambient temperature between -20°C and 70°C under air convection. It is equipped with constant current mode for overload protection, fitting various inductive or capacitive applications. The complete protection functions and relevant certificates for industrial control apparatus (UL508, IEC 60950-1 CB approved by UL.) make TDR-480 a very competitive power supply solution for industrial applications.

■ Model Encoding

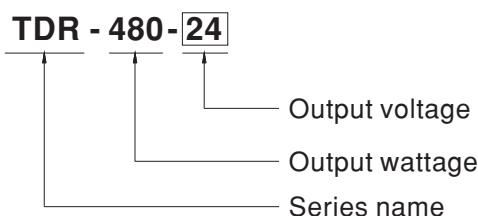



SPECIFICATION

| MODEL | | TDR-480-24 | TDR-480-48 | |
|--------------------------------------|---|--|--|--------------------------|
| OUTPUT | DC VOLTAGE | 24V | 48V | |
| | RATED CURRENT | 20A | 10A | |
| | CURRENT RANGE | 0 ~ 20A | 0 ~ 10A | |
| | RATED POWER | 480W | 480W | |
| | RIPPLE & NOISE (max.) <small>Note.2</small> | 150mVp-p | 150mVp-p | |
| | VOLTAGE ADJ. RANGE | 24 ~ 28V | 48 ~ 55V | |
| | VOLTAGE TOLERANCE <small>Note.3</small> | ± 1.0% | ± 1.0% | |
| | LINE REGULATION | ± 0.5% | ± 0.5% | |
| | LOAD REGULATION | ± 1.0% | ± 1.0% | |
| | SETUP, RISE TIME | 1200ms, 60ms/400VAC 800ms, 60ms/500VAC at full load | | |
| HOLD UP TIME (Typ.) | 20ms / 400VAC 20ms / 500VAC at full load | | | |
| INPUT | VOLTAGE RANGE <small>Note.4</small> | Three-Phase 340 ~ 550VAC (Dual phase operation possible) 480 ~ 780VDC | | |
| | FREQUENCY RANGE | 47 ~ 63Hz | | |
| | POWER FACTOR (Typ.) | PF ≥ 0.9/400VAC PF ≥ 0.88/500VAC at full load | | |
| | EFFICIENCY (Typ.) | 92.5% | 93% | |
| | AC CURRENT (Typ.) | 0.85A/400VAC 0.7A/500VAC | | |
| | INRUSH CURRENT (Typ.) | COLD START 50A | | |
| | LEAKAGE CURRENT | <3.5mA / 530VAC | | |
| PROTECTION | OVERLOAD | 105 ~ 130% rated output power Protection type : Constant current limiting, unit will shut down after 3 sec. ,re-power on to recover | | |
| | OVER VOLTAGE | 29 ~ 33V | 56 ~ 65V | |
| | OVER TEMPERATURE | Shut down o/p voltage, recovers automatically after temperature goes down | | |
| ENVIRONMENT | WORKING TEMP. <small>Note.5</small> | -30 ~ +70°C (Refer to "Derating Curve") | | |
| | WORKING HUMIDITY | 20 ~ 95% RH non-condensing | | |
| | STORAGE TEMP., HUMIDITY | -40 ~ +85°C, 10 ~ 95% RH | | |
| | TEMP. COEFFICIENT | ± 0.03%/°C (0 ~ 50°C) | | |
| | VIBRATION | Component:10 ~ 500Hz, 2G 10min./1cycle, 60min. each along X, Y, Z axes; Mounting: Compliance to IEC60068-2-6 | | |
| SAFETY & EMC <small>(Note 4)</small> | SAFETY STANDARDS | UL508, IEC60950-1 CB approved by UL | | |
| | WITHSTAND VOLTAGE | I/P-O/P:3KVAC I/P-FG:2KVAC O/P-FG:0.5KVAC O/P-DC OK(optional):0.5KVAC | | |
| | ISOLATION RESISTANCE | I/P-O/P, I/P-FG, O/P-FG:>100M Ohms / 500VDC / 25°C / 70% RH | | |
| | EMC EMISSION | Parameter | Standard | Test Level / Note |
| | | Conducted | EN55032(CISPR32) / EN61204-3 | Class B |
| | | Radiated | EN55032(CISPR32) / EN61204-3 | Class B |
| | | Harmonic Current | EN61000-3-2 | Class A |
| | | Voltage Flicker | EN61000-3-3 | ----- |
| | EMC IMMUNITY | EN55024 , EN60601-1-2, EN61204-3 | | |
| | | Parameter | Standard | Test Level / Note |
| ESD | | EN61000-4-2 | Level 4, 15KV air ; Level 4, 8KV contact | |
| Radiated Field | | EN61000-4-3 | Level 3 | |
| EFT / Burst | | EN61000-4-4 | Level 3 | |
| Surge | | EN61000-4-5 | Level 4, 2KV / Line-Line, Level 4, 4KV/ Line-Earth | |
| Conducted | | EN61000-4-6 | Level 3 | |
| Magnetic Field | | EN61000-4-8 | Level 4 | |
| Voltage Dips and Interruptions | EN61000-4-11 | > 95% dip 0.5 periods, 30% dip 25 periods > 95% interruptions 250 periods | | |
| OTHERS | MTBF | 391.7K hrs min. Telcordia SR-332(Bellcore) ; 108.2K hrs min. MIL-HDBK-217F (25°C) | | |
| | DIMENSION | 85.5*125.2*128.5mm (W*H*D) | | |
| | PACKING | 1.51Kg ; 8pcs/13Kg/1.16CUFT | | |
| NOTE | <p>1. All parameters NOT specially mentioned are measured at 400VAC input, rated load and 25°C of ambient temperature.</p> <p>2. Ripple & noise are measured at 20MHz of bandwidth by using a 12" twisted pair-wire terminated with a 0.1uf & 47uf parallel capacitor.</p> <p>3. Tolerance : includes set up tolerance, line regulation and load regulation.</p> <p>4. Dual phase operation is allowed under certain derating to output load. Please refer to derating curves for details.</p> <p>5. Installation clearances : 40mm on top, 20mm on the bottom, 5mm on the left and right side are recommended when loaded permanently with full power. In case the adjacent device is a heat source, 15mm clearance is recommended.</p> <p>6. The power supply is considered as an independent unit, but the final equipment still need to re-confirm that the whole system complies with the EMC directives. For guidance on how to perform these EMC tests, please refer to "EMI testing of component power supplies." (as available on http://www.meanwell.com)</p> | | | |

Block Diagram

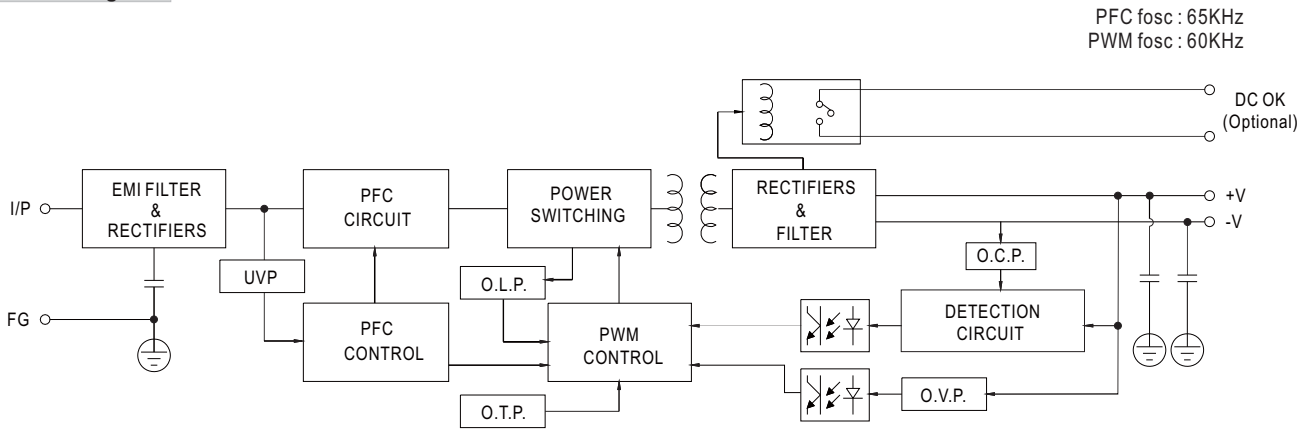

Derating Curve

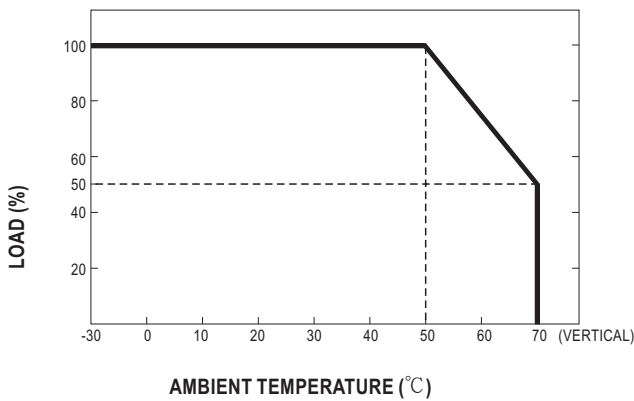

Output derating VS input voltage

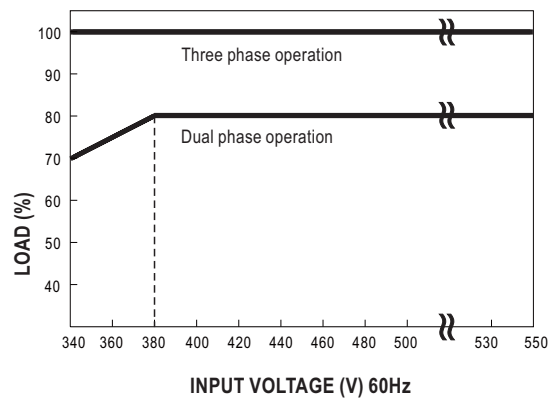

DC OK Relay Contact (Optional)

| | |
|------------------------|--|
| Contact Close | PSU turns on / DC OK. |
| Contact Open | PSU turns off / DC Fail. |
| Contact Ratings (max.) | 60VDC/0.3A, 30VDC/1A, 30VAC/0.5A resistive load. |

Control Pin (Optional) : DINKLE ECH250R-02P or equivalent (CN25)

| Pin No. | Assignment | Mating Housing | Wire Diameter |
|---------|---------------------|---|---------------------------------------|
| 1,2 | DC OK Relay Contact | Dinkle ESC250V-02P or equivalent (Including in the package) | 0.081~0.517mm ² (20~28AWG) |

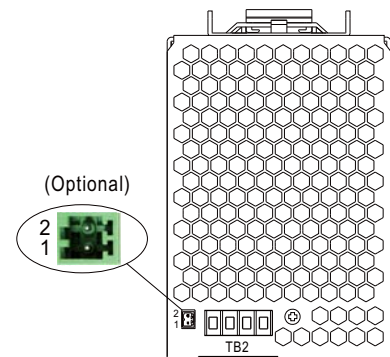

※ Please contact MEAN WELL for more details.

Mechanical Specification

Case No.984E Unit:mm

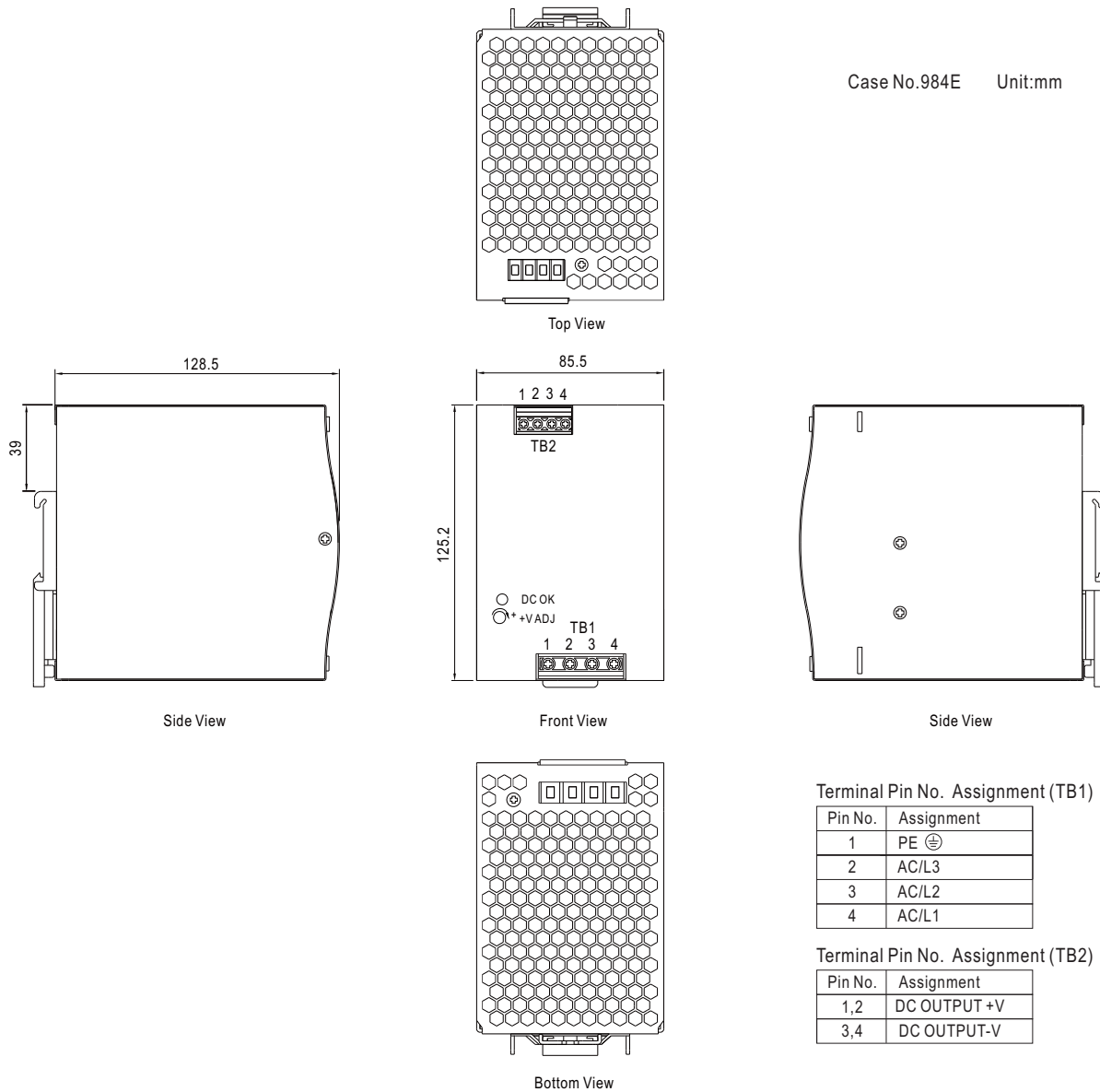

Installation Instruction

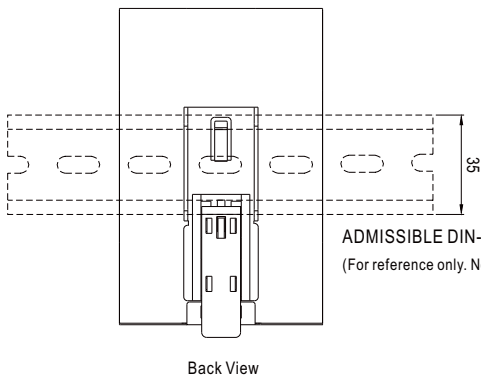

ADMISSIBLE DIN-RAIL: TS35/7.5 OR TS35/15
(For reference only. Not included with unit.)

This series fits DIN rail TS35/7.5 or TS35/15.
For installation details, please refer to the Instruction manual.

Installation Manual

Please refer to : <http://www.meanwell.com/manual.html>