



MICROCHIP

**MCP19035
600 kHz Synchronous
Buck Controller
Evaluation Board
User's Guide**

Note the following details of the code protection feature on Microchip devices:

- Microchip products meet the specification contained in their particular Microchip Data Sheet.
- Microchip believes that its family of products is one of the most secure families of its kind on the market today, when used in the intended manner and under normal conditions.
- There are dishonest and possibly illegal methods used to breach the code protection feature. All of these methods, to our knowledge, require using the Microchip products in a manner outside the operating specifications contained in Microchip's Data Sheets. Most likely, the person doing so is engaged in theft of intellectual property.
- Microchip is willing to work with the customer who is concerned about the integrity of their code.
- Neither Microchip nor any other semiconductor manufacturer can guarantee the security of their code. Code protection does not mean that we are guaranteeing the product as "unbreakable."

Code protection is constantly evolving. We at Microchip are committed to continuously improving the code protection features of our products. Attempts to break Microchip's code protection feature may be a violation of the Digital Millennium Copyright Act. If such acts allow unauthorized access to your software or other copyrighted work, you may have a right to sue for relief under that Act.

Information contained in this publication regarding device applications and the like is provided only for your convenience and may be superseded by updates. It is your responsibility to ensure that your application meets with your specifications. MICROCHIP MAKES NO REPRESENTATIONS OR WARRANTIES OF ANY KIND WHETHER EXPRESS OR IMPLIED, WRITTEN OR ORAL, STATUTORY OR OTHERWISE, RELATED TO THE INFORMATION, INCLUDING BUT NOT LIMITED TO ITS CONDITION, QUALITY, PERFORMANCE, MERCHANTABILITY OR FITNESS FOR PURPOSE. Microchip disclaims all liability arising from this information and its use. Use of Microchip devices in life support and/or safety applications is entirely at the buyer's risk, and the buyer agrees to defend, indemnify and hold harmless Microchip from any and all damages, claims, suits, or expenses resulting from such use. No licenses are conveyed, implicitly or otherwise, under any Microchip intellectual property rights.

Trademarks

The Microchip name and logo, the Microchip logo, dsPIC, FlashFlex, KEELOQ, KEELOQ logo, MPLAB, PIC, PICmicro, PICSTART, PIC³² logo, rfPIC, SST, SST Logo, SuperFlash and UNI/O are registered trademarks of Microchip Technology Incorporated in the U.S.A. and other countries.

FilterLab, Hampshire, HI-TECH C, Linear Active Thermistor, MTP, SEEVAL and The Embedded Control Solutions Company are registered trademarks of Microchip Technology Incorporated in the U.S.A.

Silicon Storage Technology is a registered trademark of Microchip Technology Inc. in other countries.

Analog-for-the-Digital Age, Application Maestro, BodyCom, chipKIT, chipKIT logo, CodeGuard, dsPICDEM, dsPICDEM.net, dsPICworks, dsSPEAK, ECAN, ECONOMONITOR, FanSense, HI-TIDE, In-Circuit Serial Programming, ICSP, Mindi, MiWi, MPASM, MPF, MPLAB Certified logo, MPLIB, MPLINK, mTouch, Omniscent Code Generation, PICC, PICC-18, PICDEM, PICDEM.net, PICkit, PICtail, REAL ICE, rLAB, Select Mode, SQI, Serial Quad I/O, Total Endurance, TSHARC, UniWinDriver, WiperLock, ZENA and Z-Scale are trademarks of Microchip Technology Incorporated in the U.S.A. and other countries.

SQTP is a service mark of Microchip Technology Incorporated in the U.S.A.

GestIC and ULPP are registered trademarks of Microchip Technology Germany II GmbH & Co. KG, a subsidiary of Microchip Technology Inc., in other countries.

All other trademarks mentioned herein are property of their respective companies.

© 2013, Microchip Technology Incorporated, Printed in the U.S.A., All Rights Reserved.

 Printed on recycled paper.

ISBN: 978-1-62077-176-1

**QUALITY MANAGEMENT SYSTEM
CERTIFIED BY DNV
= ISO/TS 16949 =**

Microchip received ISO/TS-16949:2009 certification for its worldwide headquarters, design and wafer fabrication facilities in Chandler and Tempe, Arizona; Gresham, Oregon and design centers in California and India. The Company's quality system processes and procedures are for its PIC[®] MCUs and dsPIC[®] DSCs, KEELOQ[®] code hopping devices, Serial EEPROMs, microperipherals, nonvolatile memory and analog products. In addition, Microchip's quality system for the design and manufacture of development systems is ISO 9001:2000 certified.

Object of Declaration: MCP19035 600 kHz Synchronous Buck Controller Evaluation Board

EU Declaration of Conformity

This declaration of conformity is issued by the manufacturer.

The development/evaluation tool is designed to be used for research and development in a laboratory environment. This development/evaluation tool is not a Finished Appliance, nor is it intended for incorporation into Finished Appliances that are made commercially available as single functional units to end users under EU EMC Directive 2004/108/EC and as supported by the European Commission's Guide for the EMC Directive 2004/108/EC (8th February 2010).

This development/evaluation tool complies with EU RoHS2 Directive 2011/65/EU.

For information regarding the exclusive, limited warranties applicable to Microchip products, please see Microchip's standard terms and conditions of sale, which are printed on our sales documentation and available at www.microchip.com.

Signed for and on behalf of Microchip Technology Inc. at Chandler, Arizona, USA



Derek Carlson
VP Development Tools



Date

NOTES:



MCP19035 600 KHZ SYNCHRONOUS BUCK CONTROLLER EVALUATION BOARD USER'S GUIDE

Table of Contents

Preface	7
Introduction.....	7
Document Layout	7
Conventions Used in this Guide	8
Recommended Reading.....	9
The Microchip Web Site	9
Customer Support	9
Document Revision History	9
Chapter 1. Product Overview	
1.1 Introduction	11
1.2 Short Overview: MCP19035	11
1.3 What is the MCP19035 600 kHz Synchronous Buck Controller Evaluation Board?	12
1.4 What the MCP19035 600 kHz Synchronous Buck Controller Evaluation Board Kit Contains	12
Chapter 2. Installation and Operation	
2.1 Introduction	13
2.1.1 MCP19035 600 kHz Synchronous Buck Controller Evaluation Board Features	13
2.2 Getting Started	13
2.2.1 Necessary Instruments and Tools	13
2.2.2 Setup Procedure	13
2.2.3 Board Testing	14
Appendix A. Schematic and Layouts	
A.1 Introduction	17
A.2 Board – Schematic	18
A.3 Board – Top Silk	19
A.4 Board – Top Copper and Silk	20
A.5 Board – Top Copper	21
A.6 Board – Mid Layer 1	22
A.7 Board – Mid Layer 2	23
A.8 Board – Bottom Copper	24
A.9 Board – Bottom Copper and Silk	25

Appendix B. Bill of Materials

Appendix C. Typical Performance Data, Curves and Waveforms

C.1 Introduction 29

Worldwide Sales and Service 38



MCP19035 600 KHZ SYNCHRONOUS BUCK CONTROLLER EVALUATION BOARD USER'S GUIDE

Preface

NOTICE TO CUSTOMERS

All documentation becomes dated, and this manual is no exception. Microchip tools and documentation are constantly evolving to meet customer needs, so some actual dialogs and/or tool descriptions may differ from those in this document. Please refer to our web site (www.microchip.com) to obtain the latest documentation available.

Documents are identified with a "DS" number. This number is located on the bottom of each page, in front of the page number. The numbering convention for the DS number is "DSXXXXA", where "XXXX" is the document number and "A" is the revision level of the document.

For the most up-to-date information on development tools, see the MPLAB® IDE online help. Select the Help menu, and then Topics to open a list of available online help files.

INTRODUCTION

This chapter contains general information that will be useful to know before using the MCP19035 600 kHz Synchronous Buck Controller Evaluation Board. Items discussed in this chapter include:

- Document Layout
- Conventions Used in this Guide
- Recommended Reading
- The Microchip Web Site
- Customer Support
- Document Revision History

DOCUMENT LAYOUT

This document describes how to use the MCP19035 600 kHz Synchronous Buck Controller Evaluation Board as a development tool to emulate and debug firmware on a target board. The manual layout is as follows:

- **Chapter 1. "Product Overview"** – Shows a brief description of the MCP19035 600 kHz Synchronous Buck Controller Evaluation Board
- **Chapter 2. "Installation and Operation"** – Includes instructions on how to get started with the MCP19035 600 kHz Synchronous Buck Controller Evaluation Board
- **Appendix A. "Schematic and Layouts"** – Shows the schematic and layout diagrams for the MCP19035 600 kHz Synchronous Buck Controller Evaluation Board
- **Appendix B. "Bill of Materials"** – Lists the parts used to build the MCP19035 600 kHz Synchronous Buck Controller Evaluation Board
- **Appendix C. "Typical Performance Data, Curves and Waveforms"** – Shows the typical performance graphs

CONVENTIONS USED IN THIS GUIDE

This manual uses the following documentation conventions:

DOCUMENTATION CONVENTIONS

Description	Represents	Examples
Arial font:		
Italic characters	Referenced books	<i>MPLAB[®] IDE User's Guide</i>
	Emphasized text	...is the <i>only</i> compiler...
Initial caps	A window	the Output window
	A dialog	the Settings dialog
	A menu selection	select Enable Programmer
Quotes	A field name in a window or dialog	"Save project before build"
Underlined, italic text with right angle bracket	A menu path	<u><i>File>Save</i></u>
Bold characters	A dialog button	Click OK
	A tab	Click the Power tab
N'Rnnnn	A number in verilog format, where N is the total number of digits, R is the radix and n is a digit.	4'b0010, 2'hF1
Text in angle brackets < >	A key on the keyboard	Press <Enter>, <F1>
Courier New font:		
Plain Courier New	Sample source code	#define START
	Filenames	autoexec.bat
	File paths	c:\mcc18\h
	Keywords	_asm, _endasm, static
	Command-line options	-Opa+, -Opa-
	Bit values	0, 1
	Constants	0xFF, 'A'
Italic Courier New	A variable argument	<i>file.o</i> , where <i>file</i> can be any valid filename
Square brackets []	Optional arguments	mcc18 [options] <i>file</i> [options]
Curly brackets and pipe character: { }	Choice of mutually exclusive arguments; an OR selection	errorlevel {0 1}
Ellipses...	Replaces repeated text	var_name [, var_name...]
	Represents code supplied by user	void main (void) { ... }

RECOMMENDED READING

This user's guide describes how to use the MCP19035 600 kHz Synchronous Buck Controller Evaluation Board. Other useful documents are listed below. The following Microchip documents are available and recommended as supplemental reference resources.

- **MCP19035 Data Sheet – “High-Speed Synchronous Buck Controller” (DS22326)**
- **AN1452 – “Using the MCP19035 Synchronous Buck Converter Design Tool” (DS01452)**

THE MICROCHIP WEB SITE

Microchip provides online support via our web site at www.microchip.com. This web site is used as a means to make files and information easily available to customers. Accessible by using your favorite Internet browser, the web site contains the following information:

- **Product Support** – Data sheets and errata, application notes and sample programs, design resources, user's guides and hardware support documents, latest software releases and archived software
- **General Technical Support** – Frequently Asked Questions (FAQs), technical support requests, online discussion groups, Microchip consultant program member listing
- **Business of Microchip** – Product selector and ordering guides, latest Microchip press releases, listing of seminars and events, listings of Microchip sales offices, distributors and factory representatives

CUSTOMER SUPPORT

Users of Microchip products can receive assistance through several channels:

- Distributor or Representative
- Local Sales Office
- Field Application Engineer (FAE)
- Technical Support

Customers should contact their distributor, representative or field application engineer (FAE) for support. Local sales offices are also available to help customers. A listing of sales offices and locations is included in the back of this document.

Technical support is available through the web site at:
<http://www.microchip.com/support>

DOCUMENT REVISION HISTORY

Revision A (April 2013)

- Initial Release of this Document.

NOTES:



MCP19035 600 KHZ SYNCHRONOUS BUCK CONTROLLER EVALUATION BOARD USER'S GUIDE

Chapter 1. Product Overview

1.1 INTRODUCTION

This chapter provides an overview of the MCP19035 600 kHz Synchronous Buck Controller Evaluation Board and covers the following topics:

- Short Overview: MCP19035
- What is the MCP19035 600 kHz Synchronous Buck Controller Evaluation Board?
- What the MCP19035 600 kHz Synchronous Buck Controller Evaluation Board Kit Contains

1.2 SHORT OVERVIEW: MCP19035

The MCP19035 is a highly-featured, highly integrated, synchronous buck controller in a space-saving 10-pin DFN 3 x 3 mm package that operates from input voltage sources up to 30V. Integrated features include high and low-side MOSFET drivers, fixed-frequency voltage mode control, internal oscillator and reference voltage generator, overcurrent protection circuit for both sides, Power Good circuit and overtemperature protection. A minimal number of external components is necessary to develop a complete, high-performance Synchronous Buck Converter power supply.

The MCP19035 Synchronous Buck Controller is intended to be used for applications requiring medium to high-output currents (up to 20A) and input voltages up to 30V.

Typical applications include:

- Medium current Point-of-Load converters
- FPGA/DSP power supplies
- Digital Set-Top boxes
- Industrial 24V rails converters

The internal linear voltage regulator (LDO) allows low current loads (for example, PIC[®] microcontrollers) to be powered directly from this controller without any additional components.

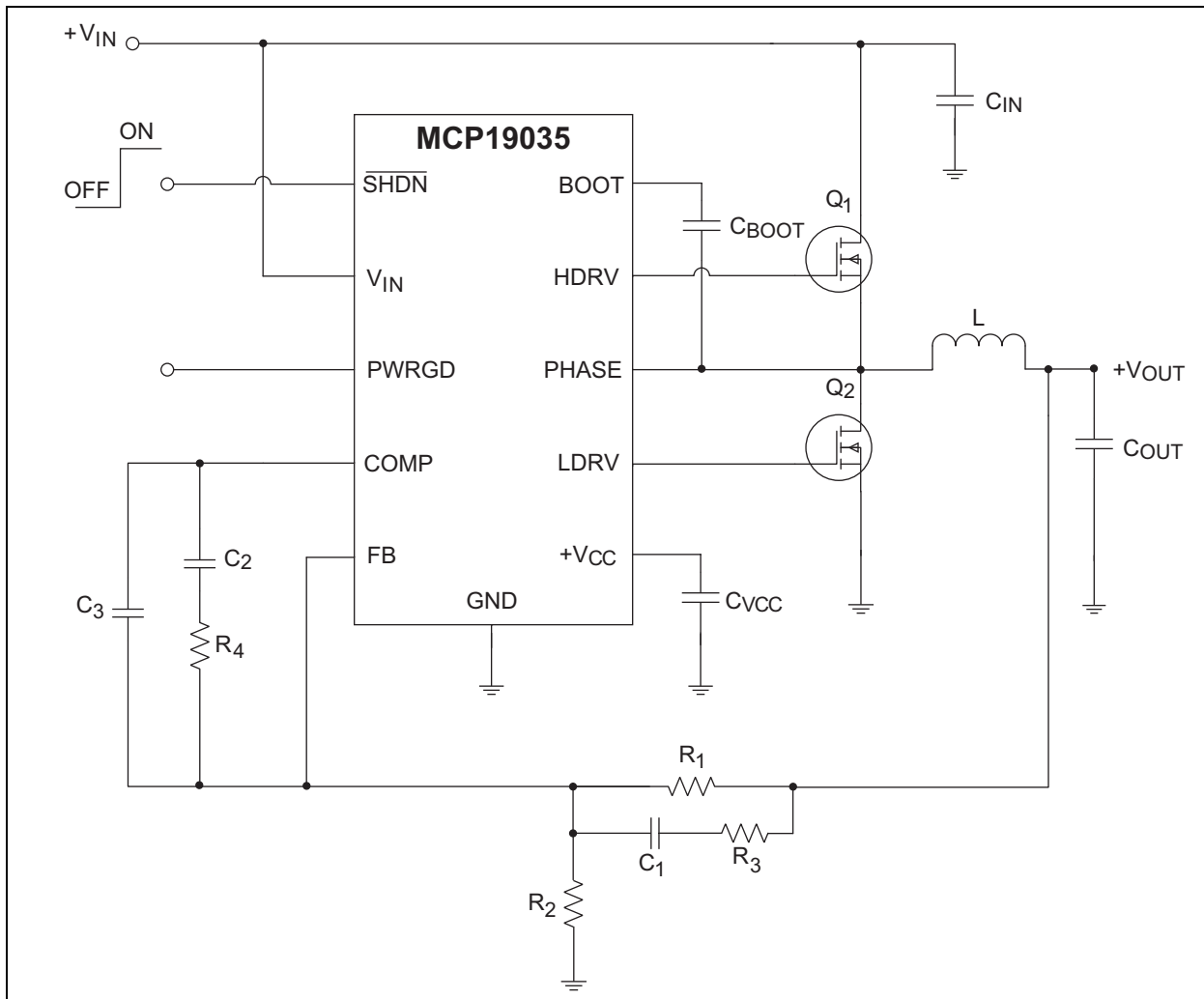

FIGURE 1-1: MCP19035 - Typical Application.

1.3 WHAT IS THE MCP19035 600 KHZ SYNCHRONOUS BUCK CONTROLLER EVALUATION BOARD?

The MCP19035 600 kHz Synchronous Buck Controller Evaluation Board is a compact, highly efficient, step-down voltage regulator that will convert the input voltage rail (typically 12V) to 1.8V regulated output voltage. The maximum output current for this step-down converter is 10A. The board demonstrates the capabilities of the MCP19035 600 kHz Synchronous Buck Converter, as well as Microchip's high-performance power MOSFET transistors. Test points for various signals are provided for measuring different parameters of the converter. The evaluation board can be modified to support output voltages ranging from 0.9V to 3.3V by changing a single resistor.

1.4 WHAT THE MCP19035 600 KHZ SYNCHRONOUS BUCK CONTROLLER EVALUATION BOARD KIT CONTAINS

The MCP19035 600 kHz Synchronous Buck Controller Evaluation Board kit includes:

- MCP19035 600 kHz Synchronous Buck Controller Evaluation Board (ADM00445)
- Important Information Sheet

Chapter 2. Installation and Operation

2.1 INTRODUCTION

2.1.1 MCP19035 600 kHz Synchronous Buck Controller Evaluation Board Features

The MCP19035 600 kHz Synchronous Buck Controller Evaluation Board was developed to provide a compact, low-cost and highly efficient step-down conversion for low to medium output currents.

The key features of this board include:

- Input Voltage Range: 8V to 14V
- Output Voltage: 1.8V (can be adjusted by changing one resistor between 0.9V and 3.3V)
- Maximum Output Current: 10A
- 88% typical efficiency at 1.8V/10A output and 12V input
- 600 kHz fixed switching frequency
- On-board High Performance Power MOSFET Transistors
- Overcurrent Protection for High and Low-Side MOSFETs
- Power Good (PGOOD) output for monitoring the output voltage quality
- Shutdown input for placing the converter in low-power Standby mode
- Under Voltage Lockout (UVLO) with 4.2V and 3.6V typical thresholds

2.2 GETTING STARTED

The MCP19035 600 kHz Synchronous Buck Controller Evaluation Board is fully assembled and tested to evaluate and demonstrate the MCP19035 capabilities.

2.2.1 Necessary Instruments and Tools

- Adjustable DC Power Supply with 0V – 15V/5 A_{DC} range output capability
- Electronic load with at least 20A current capability and load stepping capability
- Digital oscilloscope with a minimum bandwidth of 50 MHz
- Digital voltmeter/ammeter
- Optionally, a Network Analyzer/Bode Plot Analyzer for loop analysis
- Wires for connections: they must sustain high current, 5A for the connection between adjustable DC power supply and board, 15A for the connection between the board and the electronic load

2.2.2 Setup Procedure

To power up the MCP19035 600 kHz Synchronous Buck Controller Evaluation Board, the following steps must be completed:

1. Connect the Electronic Load to J2 connector of the evaluation board; the positive (+) and negative (-) connector pins are marked on the board silkscreen.
2. Connect the Adjustable DC Power Supply to J1 connector of the evaluation board; the positive (+) and negative (-) connector pins are marked on the board silkscreen.
3. The DC voltage supplied by the Adjustable DC Power Supply must be 12V.

2.2.3 Board Testing

The typical test setup is depicted in Figure 2-1. Table 2-1 shows all the available test points on the board.

The user can connect various instruments at the listed test points to evaluate the parameters of the converter. The typical performance data, curves and waveforms are presented in **Appendix C. "Typical Performance Data, Curves and Waveforms"**.

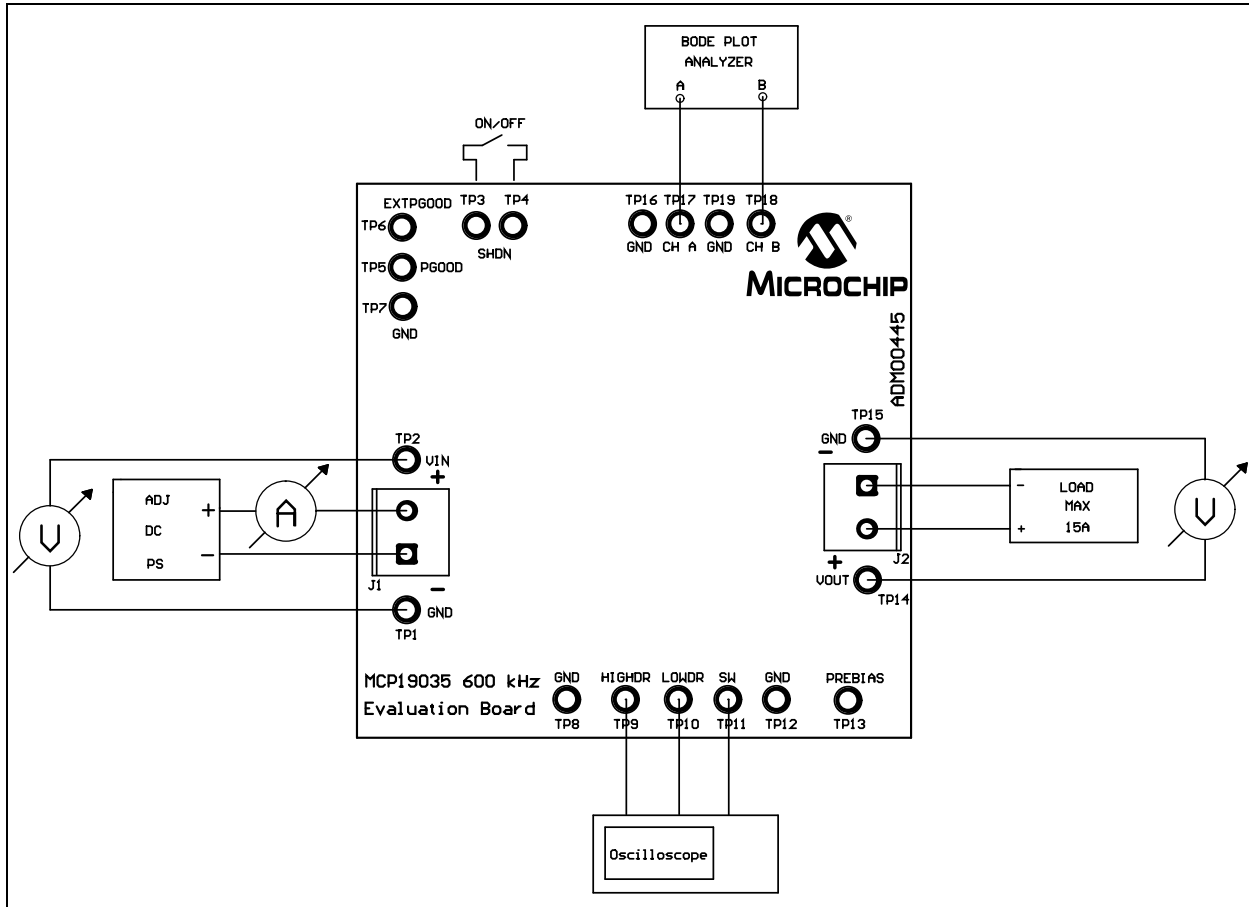

FIGURE 2-1: Typical Test Setup.

TABLE 2-1: TEST POINTS DESCRIPTION

Test Point	Label	Description
TP1, TP8, TP12, TP15	GND	Power GND
TP7, TP16, TP19	SGND	Signal GND
TP2	V_{IN}	Input Voltage
TP3	SHDN	Shutdown input pull-up resistor
TP4	SHDN	Shutdown input
TP5	PGOOD	Power Good output
TP6	EXTPGOOD	External pull-up for PGOOD signal
TP9	HIGHDR	High-Side MOSFET drive signal
TP10	LOWDR	Low-Side MOSFET drive signal
TP11	SW	Main switch node
TP13	PREBIAS	Pre-bias load point
TP14	V_{OUT}	Output Voltage
TP17, TP18	CH A, CH B	Signal Injection points for loop measurement

2.2.3.1 ADJUSTING THE OUTPUT VOLTAGE

The output voltage can be modified by changing the value of R12 from the feedback divider. The output voltage is set according to Equation 2-1.

EQUATION 2-1: OUTPUT VOLTAGE

$$V_{OUT} = V_{REF} \times \frac{R12 + R11}{R12}$$

Where:

$$\begin{aligned} V_{REF} &= 0.6V \\ R11 &= 20 \text{ k}\Omega \end{aligned}$$

Do not modify the value of the R11 resistor (20 kΩ), as this will affect the system's loop compensation.

Some parameters, including efficiency, overcurrent protection thresholds and input and output voltage ripple, can be affected by the modification of the output voltage.

Table 2-2 shows the standard values of R12 resistor for some usual output voltages.

TABLE 2-2: OUTPUT VOLTAGE VERSUS R12 VALUE

V _{OUT} (V)	R ₁₂ (kΩ)
0.9	40.2
1	30
1.2	20
1.5	13.3
1.8	10
2	8.45
2.25	7.32
2.5	6.34
3.3	4.42

NOTES:



MCP19035 600 KHZ SYNCHRONOUS BUCK CONTROLLER EVALUATION BOARD USER'S GUIDE

Appendix A. Schematic and Layouts

A.1 INTRODUCTION

This appendix contains the following schematics and layouts for the MCP19035 600 kHz Synchronous Buck Controller Evaluation Board:

- Board – Schematic
- Board – Top Silk
- Board – Top Copper and Silk
- Board – Top Copper
- Board – Mid Layer 1
- Board – Mid Layer 2
- Board – Bottom Copper
- Board – Bottom Copper and Silk

A.3 BOARD – TOP SILK

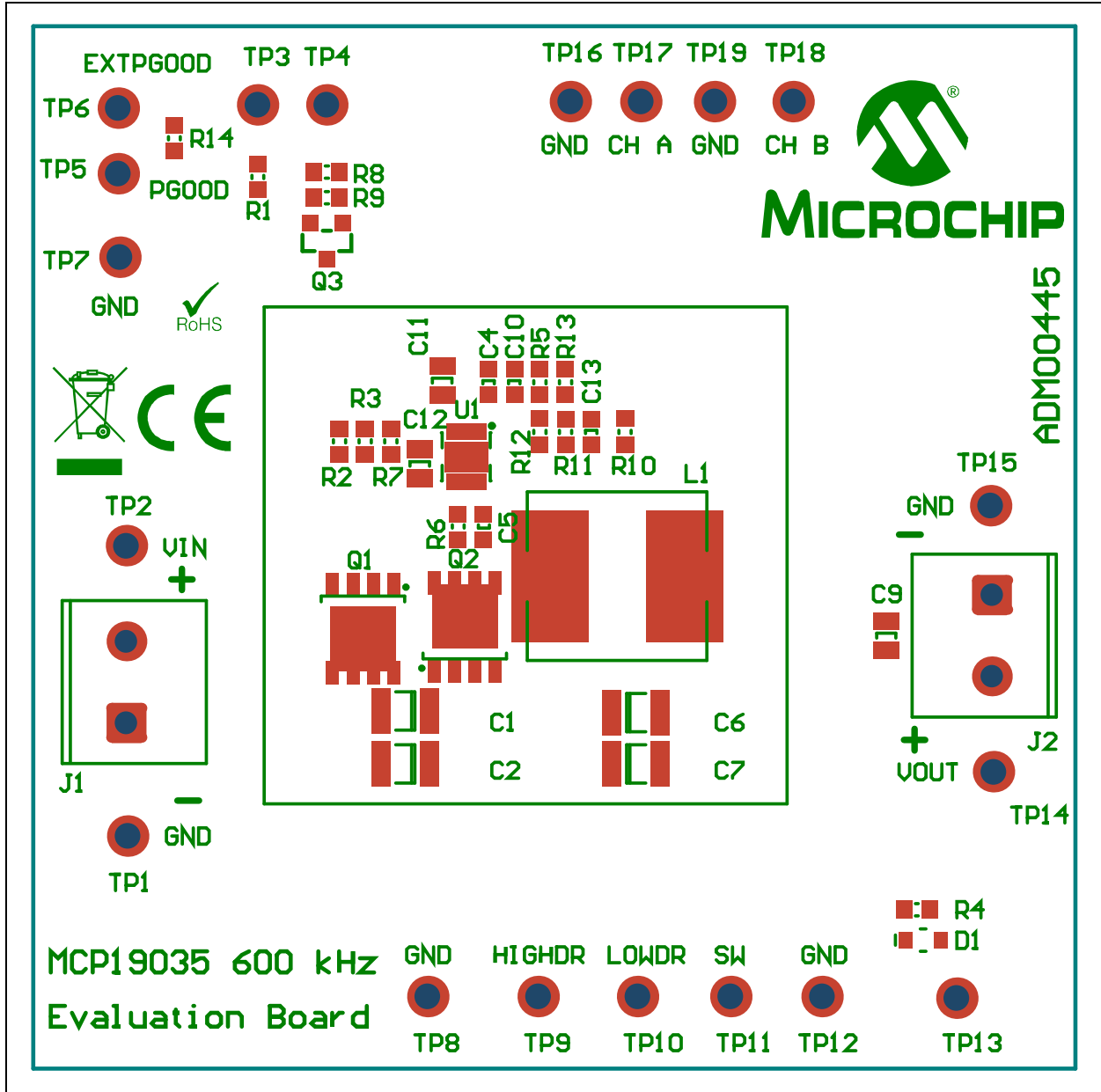

A.4 BOARD – TOP COPPER AND SILK

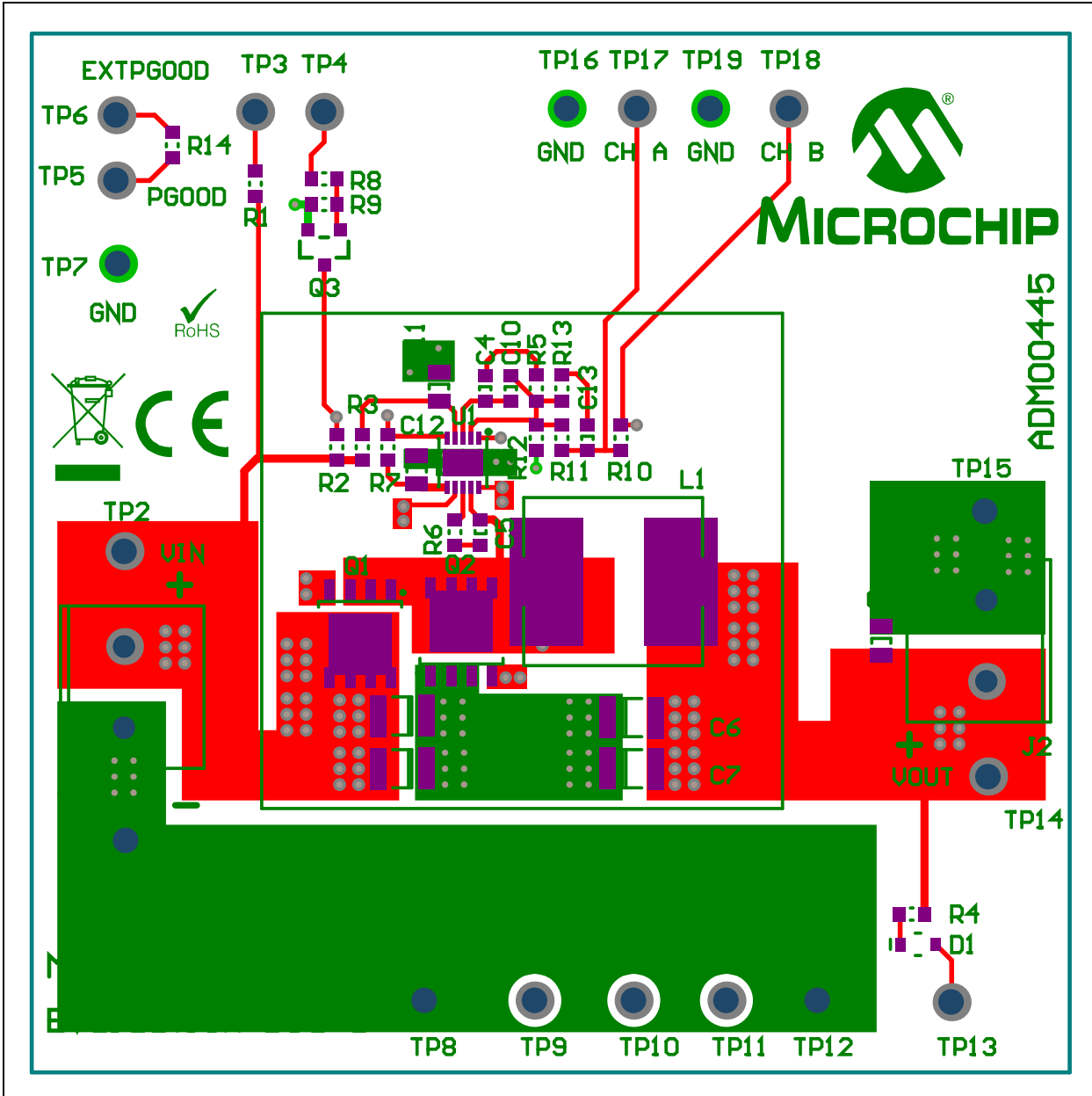

A.5 BOARD – TOP COPPER

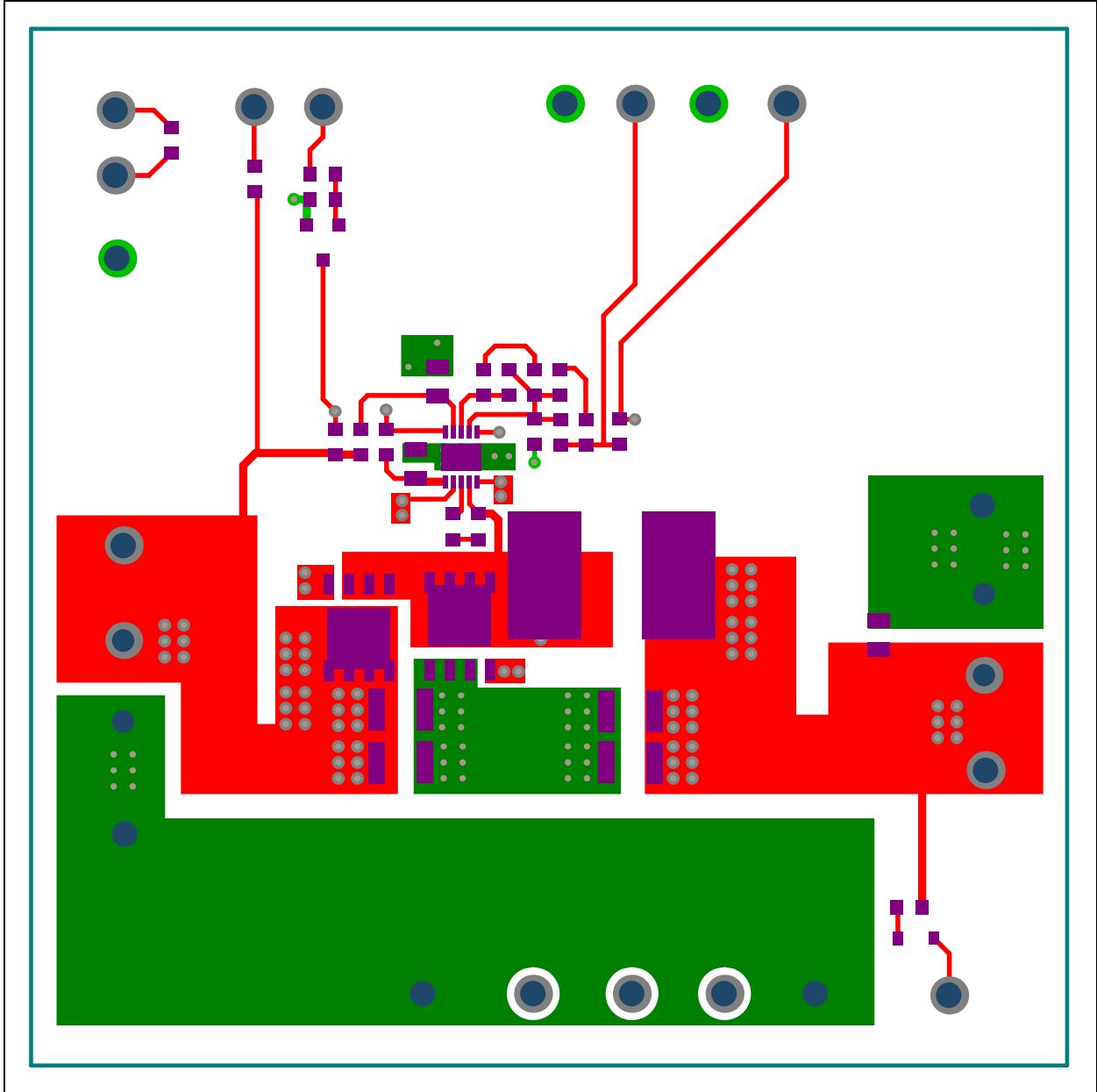

A.7 BOARD – MID LAYER 2

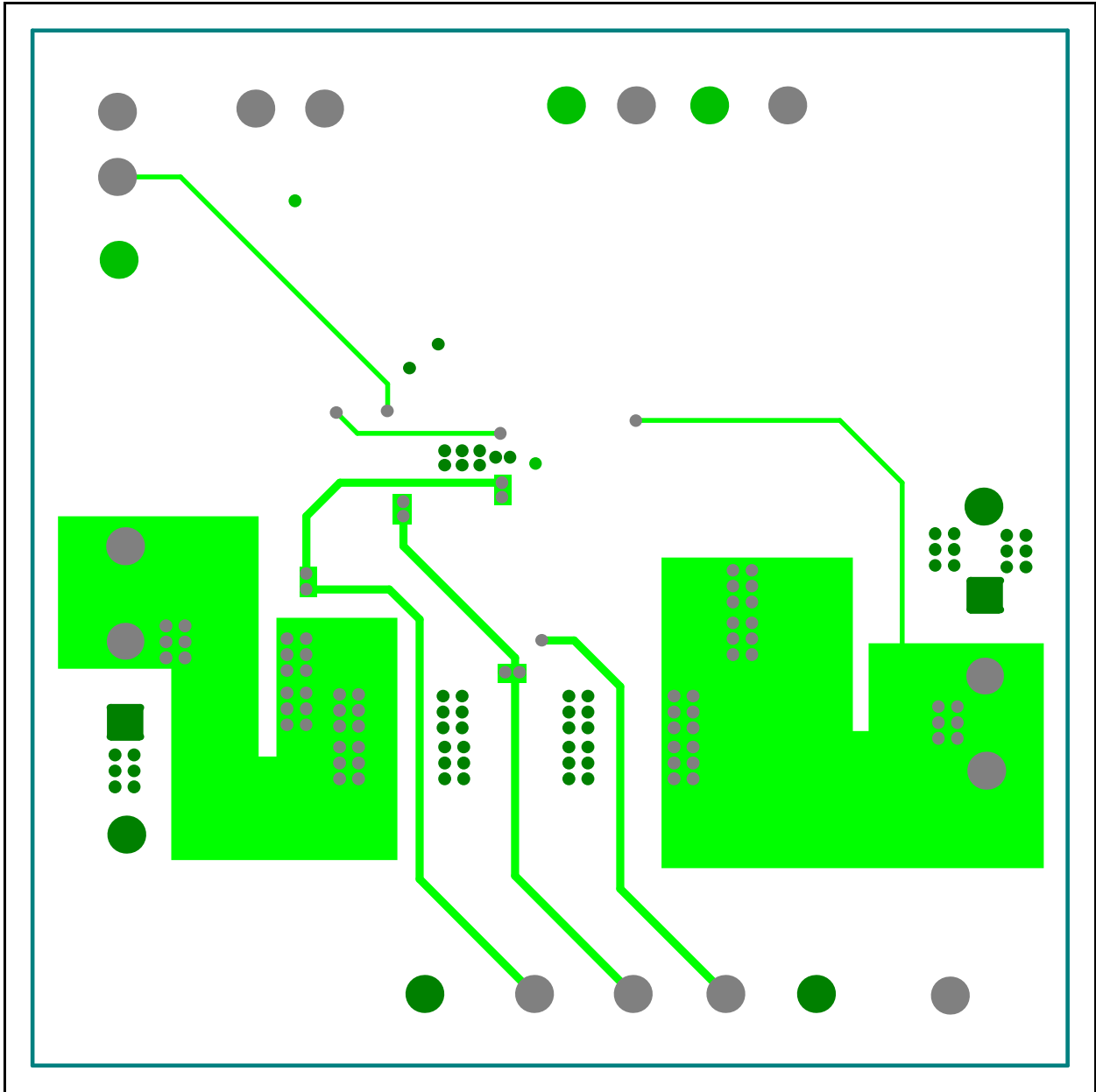

A.8 BOARD – BOTTOM COPPER

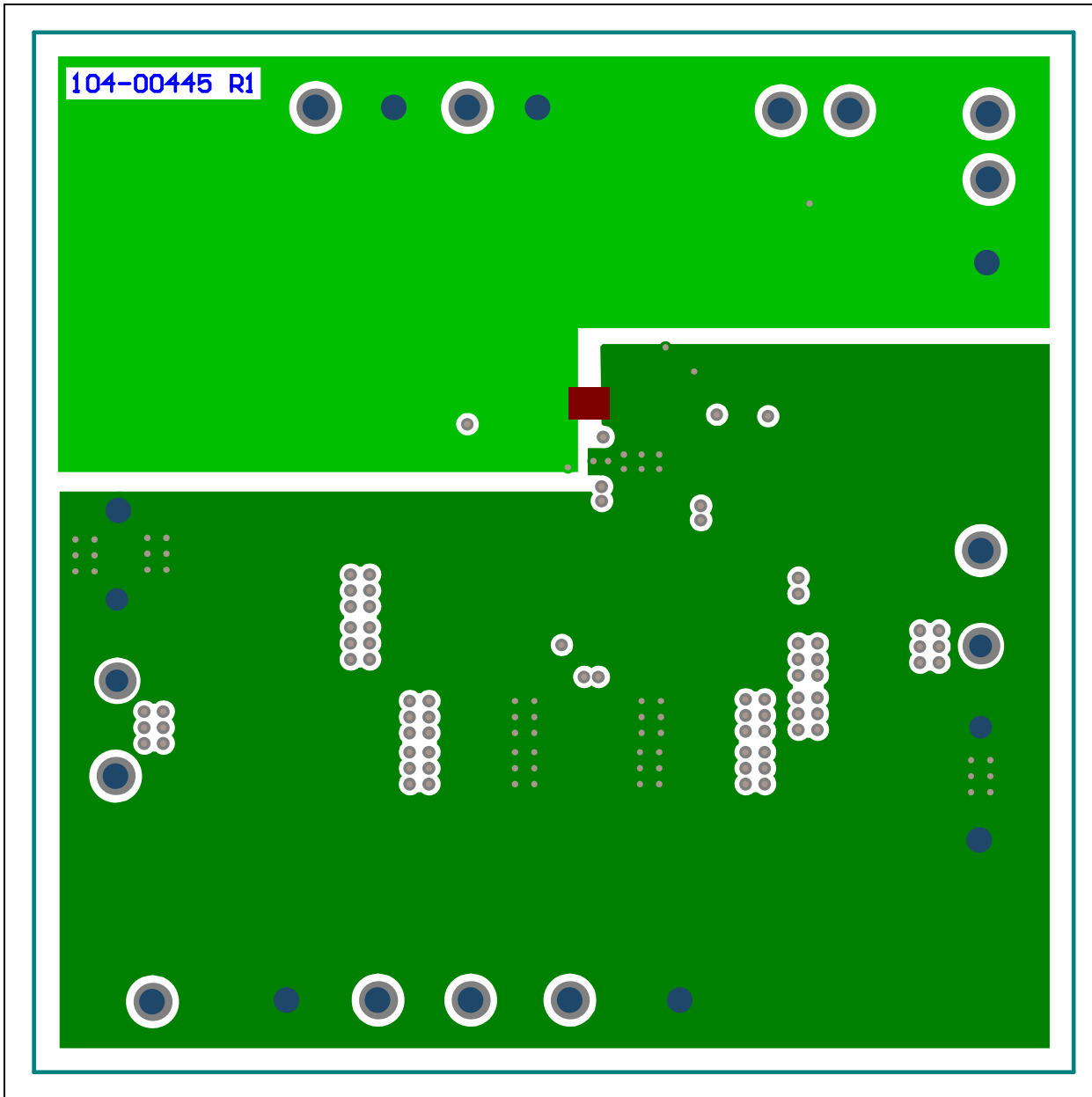

A.9 BOARD – BOTTOM COPPER AND SILK

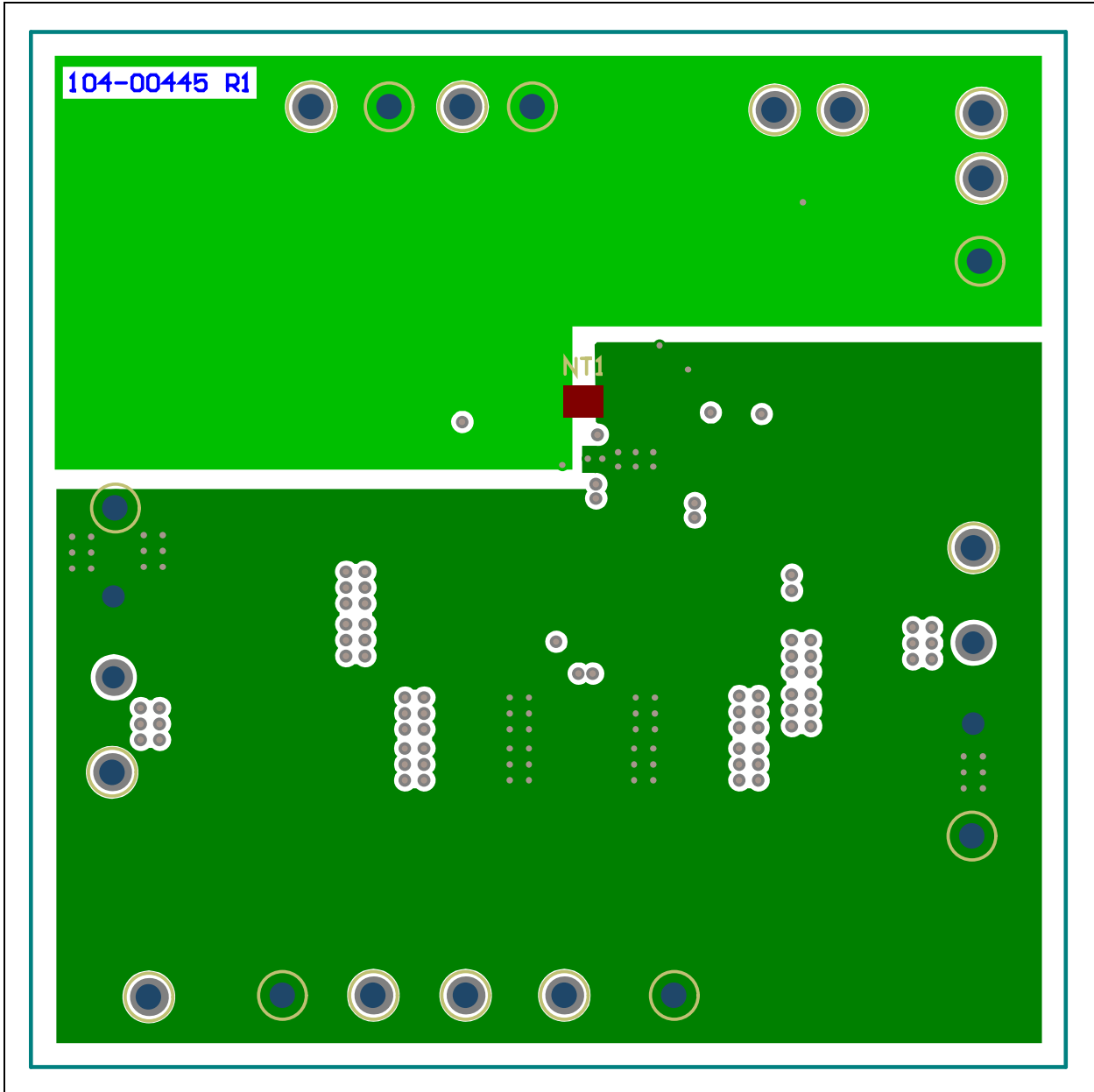

NOTES:



MCP19035 600 KHZ SYNCHRONOUS BUCK CONTROLLER EVALUATION BOARD USER'S GUIDE

Appendix B. Bill of Materials

TABLE B-1: BILL OF MATERIALS (BOM)

Qty	Reference	Description	Manufacturer	Part Number
4	BUMP	Bumpon Hemisphere .44 X .20 White	3M	SJ-5003 (WHITE)
2	C1, C2	Cap. Cer. 10 μ F 25V 10% X 7R 1210	TDK Corporation	C3225X7R1E106K
1	C4	Cap. Cer. 3900PF 50V 5% NP0 0603	TDK Corporation	C1608C0G1H392J
1	C5	Cap. Cer. 0.33 μ F 16V 10% X7R 0603	Murata Electronics®	GRM188R71C334KA01D
2	C6, C7	Cap. Cer. 100 μ F 6.3V 20% X5R 1210	TDK Corporation	C3225X5R0J107M
2	C9, C11	Cap. Cer. 1 μ F 35V 10% X7R 0805	TDK Corporation	CGA4J3X7R1V105K
1	C10	Cap. Cer. 47pF 100V 5% COG 0603	AVX Corporation	06031A470JAT2A
1	C12	Cap. Cer. 4.7 μ F 25V X5R 0805	TDK Corporation	C2012X5R1E475K
1	C13	Cap. Cer. 560PF 50V 5% NP0 0603	KEMET®	C0603C561J5GACTU
1	D1	Diode Schottky 0.5A 30V SOD323	Diodes® Incorporated	B0530WS-7-F
2	J1, J2	Terminal Block 5.08MM Vert. 2 POS.	On-Shore Technology, Inc.	ED120/2DS
1	L1	Inductor Power 1.0 μ H 17A SMD	Würth Elektronik Group	7443340100
	PCB	Printed Circuit Board - MCP19035 600 kHz Synchronous Buck Controller Evaluation Board	—	104-00445
1	Q1	High Performance MOSFET Transistor	Microchip Technology Inc.	MCP87050-U/MF
1	Q2	High Performance MOSFET Transistor	Microchip Technology Inc.	MCP87022-U/MF
1	Q3	MOSFET N-Ch 60V 115MA SOT-23-3	Diodes Incorporated	2N7002-7-F
3	R1, R8, R9	Res. 5.1 kOhm 1/10W 1% 0603 SMD	Panasonic® - ECG	ERJ-3EKF5101V
2	R2, R7	Res. 100 kOhm 1/10W 1% 0603 SMD	Panasonic - ECG	ERJ-3EKF1003V
1	R3	Res. 0 Ohm 1/10W 0603 SMD	Panasonic - ECG	ERJ-3GEY0R00V
1	R4	Res. 100 Ohm 1/10W 1% 0603 SMD	Panasonic - ECG	ERJ-3EKF1000V
1	R5	Res. 7.50 kOhm 1/10W 1% 0603 SMD	Panasonic - ECG	ERJ-3EKF7501V
1	R6	Res. 3.3 Ohm 1/10W 1% 0603	Panasonic - ECG	ERJ-3RQF3R3V
2	R12, R14	Res. 10 kOhm 1/10W 1% 0603 SMD	Panasonic - ECG	ERJ-3EKF1002V
1	R10	Res. 49.9 Ohm .25W 1% 0603 SMD	Vishay/Dale	CRCW060349R9FKEAHP
1	R11	Res. 20 kOhm 1/10W 5% 0603 SMD	Panasonic - ECG	ERJ-3GEYJ203V
1	R13	Res. 750 Ohm 1/10W 1% 0603 SMD	Vishay/Dale	CRCW0603750RFKEA
19	TP1 – TP19	Test Point PC Multi Purpose Blk	Keystone Electronics Corp.	5011
1	U1	MCP19035 High Speed Synchronous Buck Controller	Microchip Technology Inc.	MCP19035-BAABE/MF

Note 1: The components listed in this Bill of Materials are representative of the PCB assembly. The released BOM used in manufacturing uses all RoHS-compliant components.

NOTES:

Appendix C. Typical Performance Data, Curves and Waveforms

C.1 INTRODUCTION

This chapter shows some of the typical performance parameters and curves of the MCP19035 600 kHz Synchronous Buck Controller Evaluation Board.

TABLE C-1: CONVERTER PARAMETERS

Parameter	Value	Comments
Input Voltage Range (V)	8 – 14	
Output Voltage (V)	1.8	±2.5% Tolerance
Maximum Output Current (A)	10	Steady State output current
Output Voltage Ripple (mV)	<30	$V_{IN} = 12V, I_{OUT} = 10A$
Input Voltage Ripple (mV)	<300	$V_{IN} = 12V, I_{OUT} = 10A$
Output Voltage Overshoot during Step Load (mV)	<100	Step Load 0A to 5A
Switching Frequency (kHz)	510 – 690	Typical 600 kHz

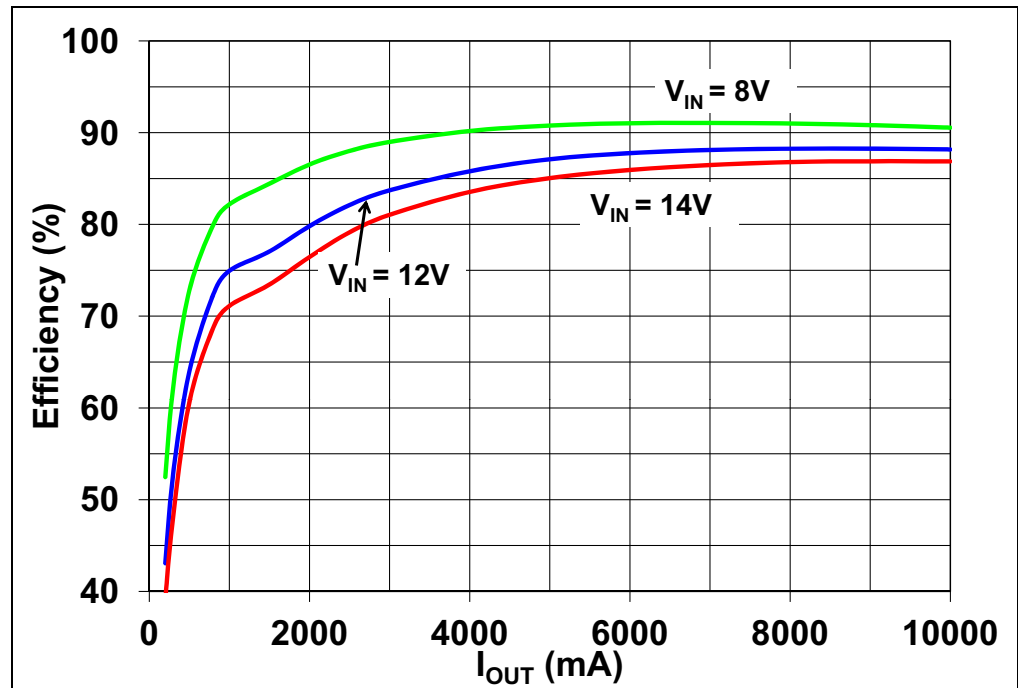

FIGURE C-1: Efficiency.

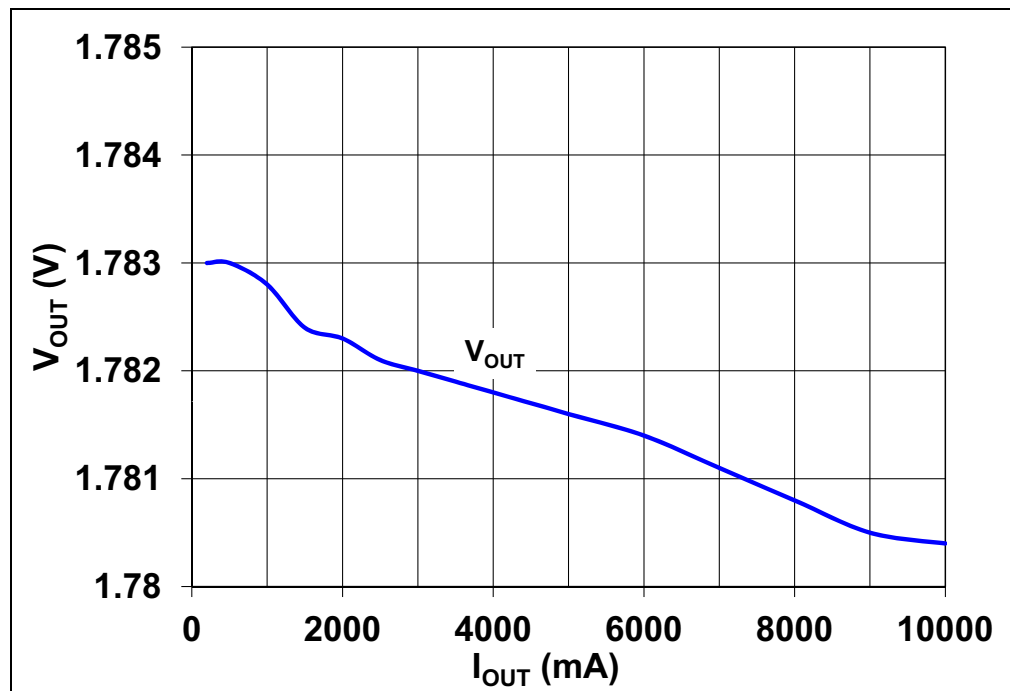

FIGURE C-2: Load Regulation ($V_{IN} = 12V$).

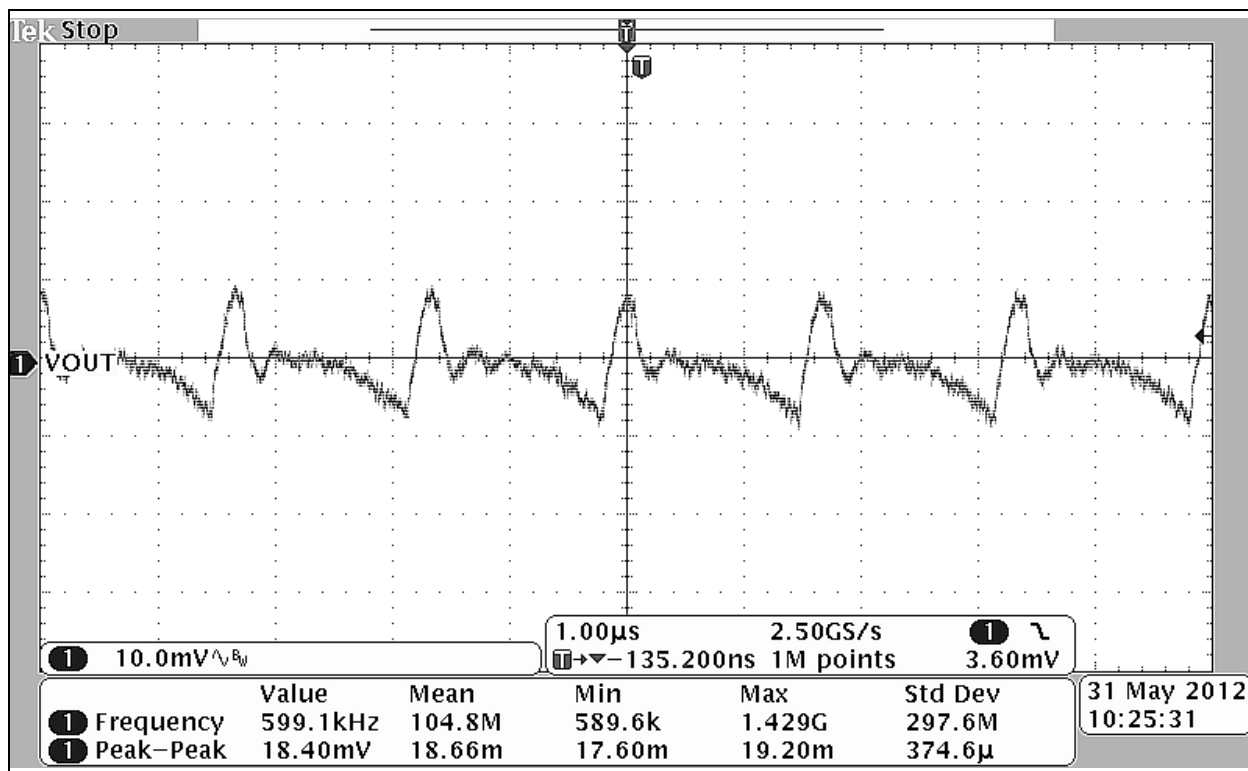

FIGURE C-3: Output Voltage Ripple/Noise ($V_{IN} = 12V$, $I_{OUT} = 10A$, $BW = 20\text{ MHz}$).

Typical Performance Data, Curves and Waveforms

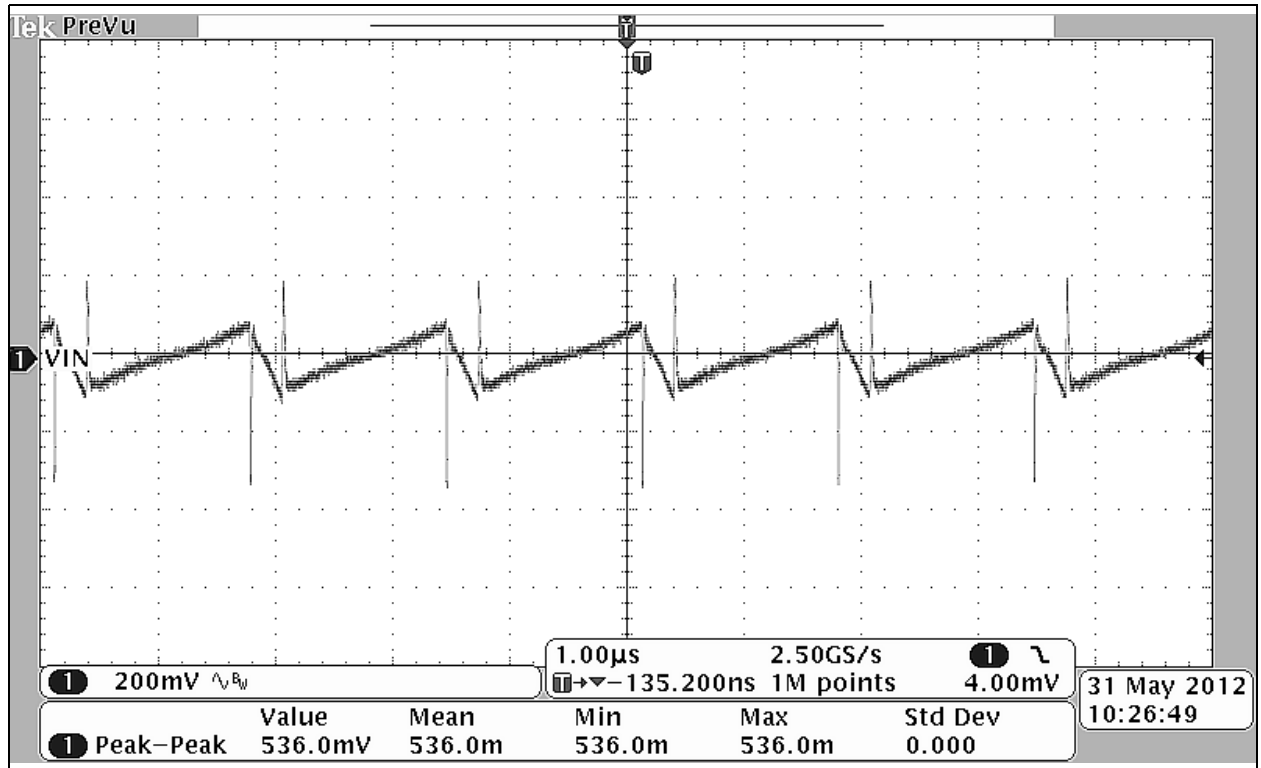

FIGURE C-4: Input Voltage Ripple/Noise ($V_{IN} = 12V$, $I_{OUT} = 10A$, $BW = 20$ MHz).

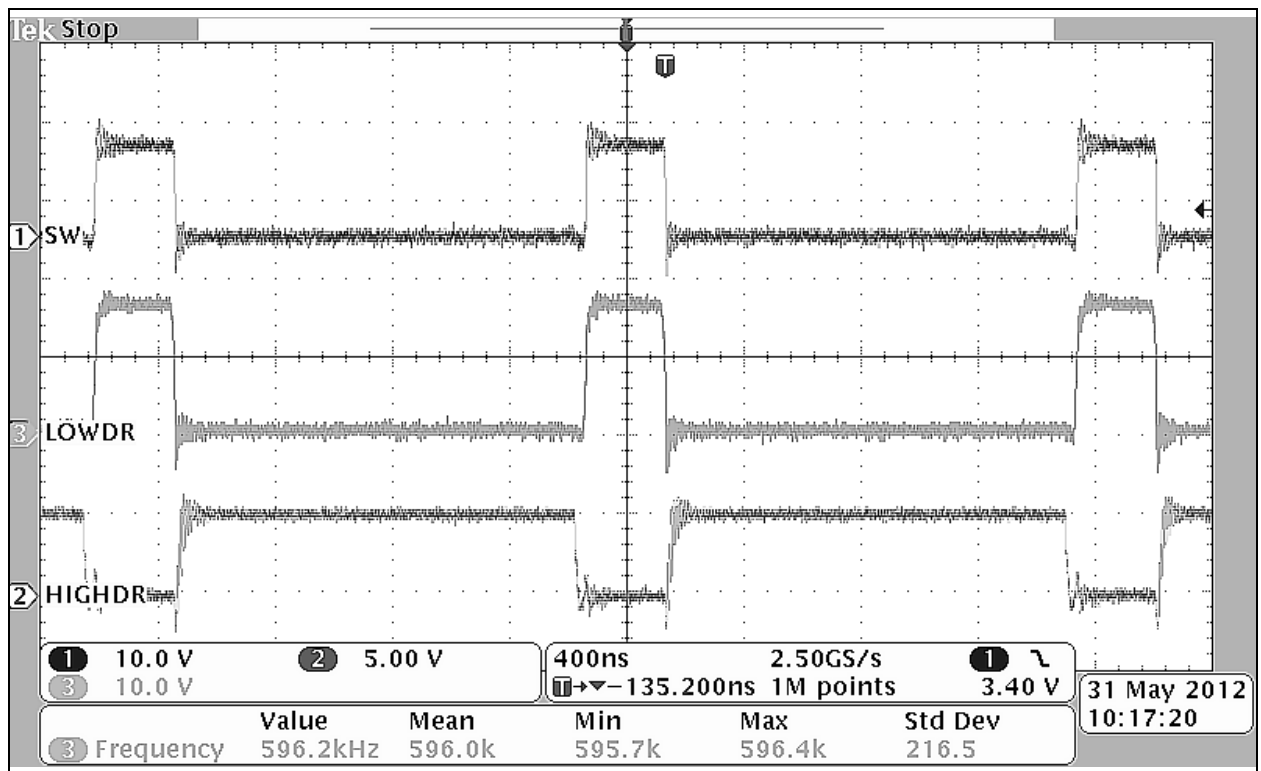

FIGURE C-5: SW (TP11), LDRV (TP10) and HDRV (TP9) Signals ($V_{IN} = 12V$, $I_{OUT} = 10A$, $BW = 300$ MHz).

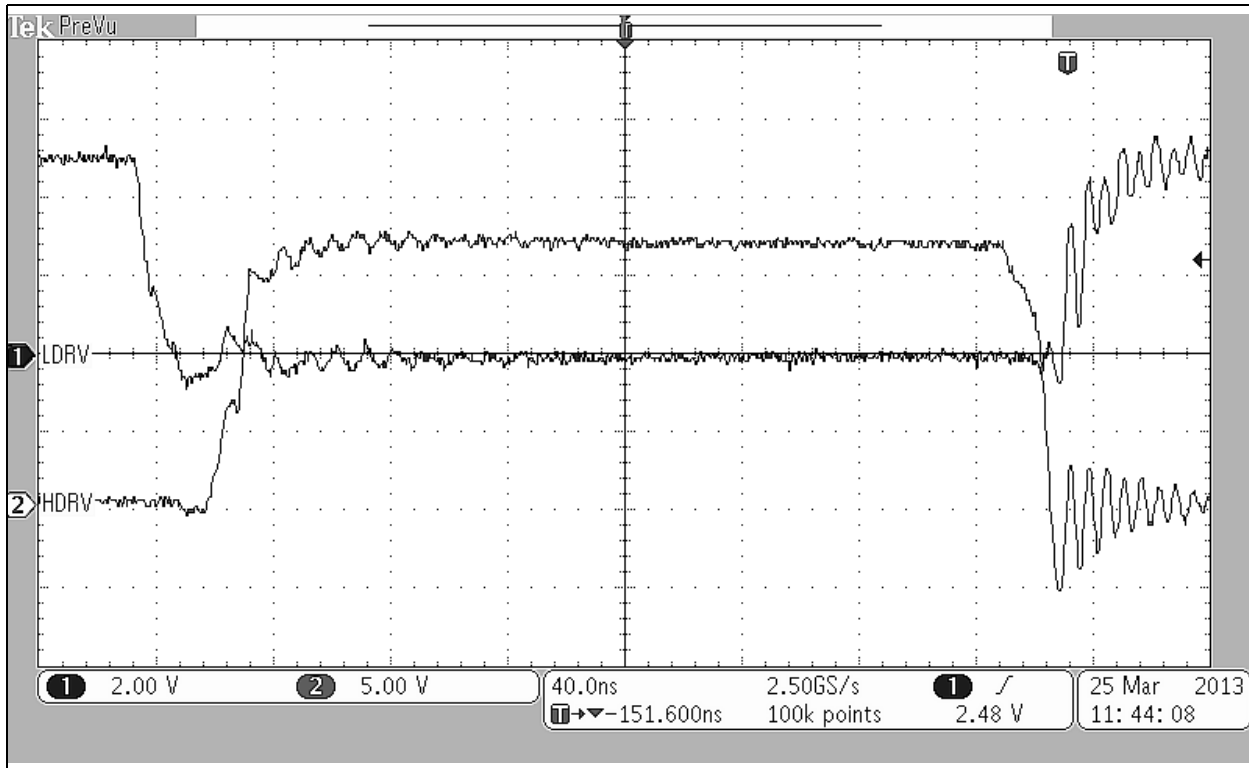

FIGURE C-6: LDRV (TP10) and HDRV (TP9) Signals ($V_{IN} = 12V$, $I_{OUT} = 10A$, $BW = 300\text{ MHz}$).

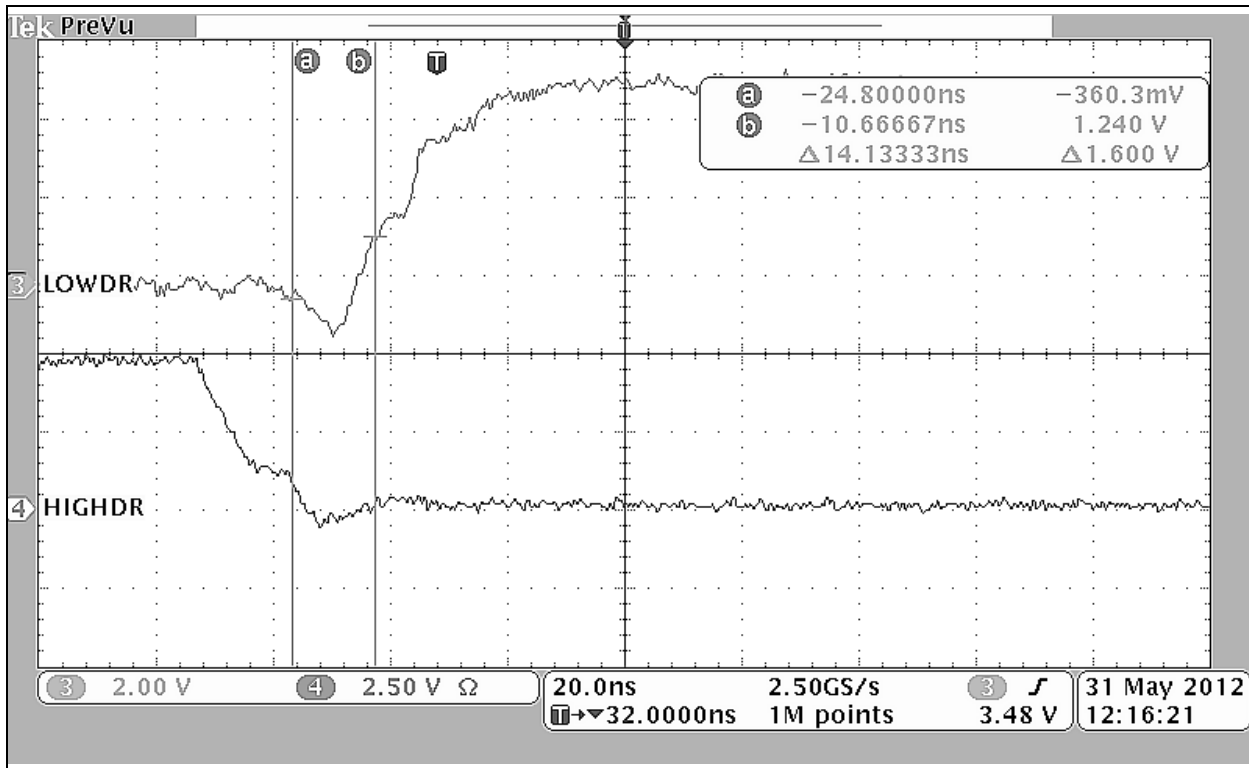

FIGURE C-7: Dead Times 1 ($V_{IN} = 12V$, $I_{OUT} = 10A$, $BW = 300\text{ MHz}$).

Typical Performance Data, Curves and Waveforms

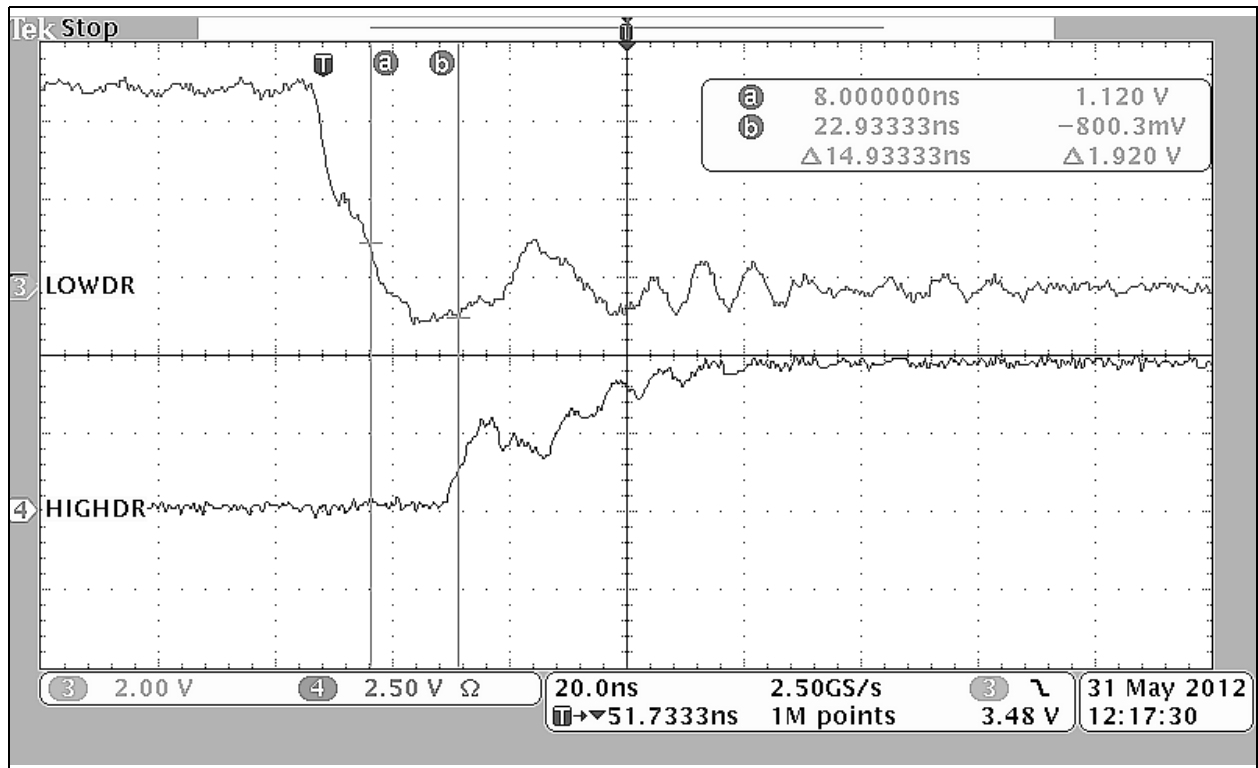

FIGURE C-8: Dead Times 2 ($V_{IN} = 12V$, $I_{OUT} = 10A$, $BW = 300\text{ MHz}$).

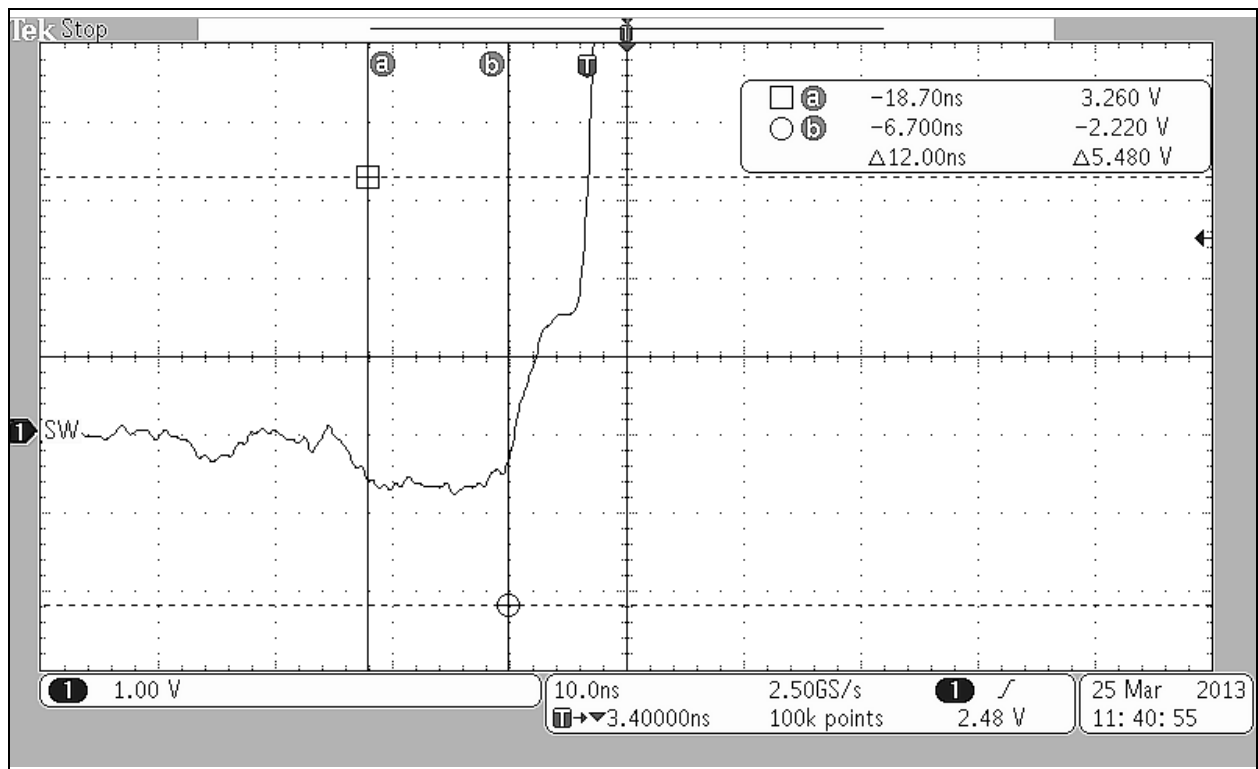

FIGURE C-9: The Body Diode Conduction Time ($V_{IN} = 12V$, $I_{OUT} = 10A$, $BW = 300\text{ MHz}$).

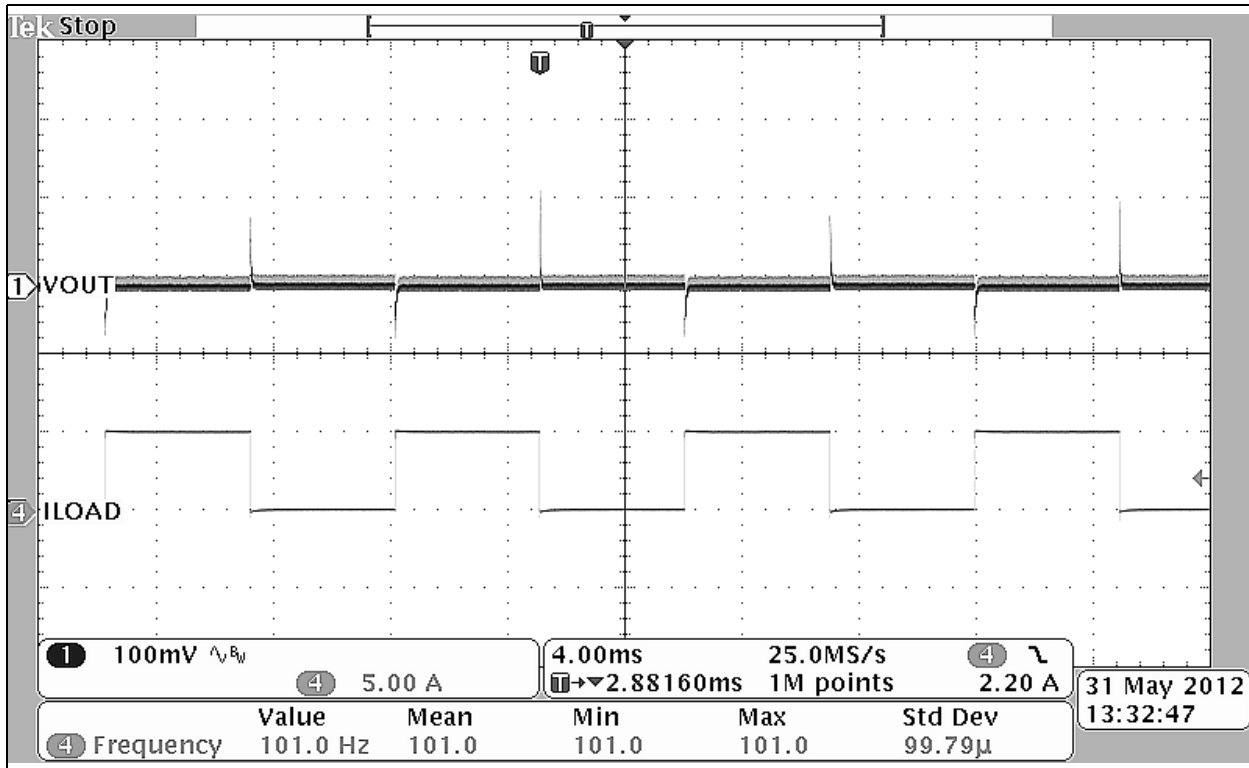

FIGURE C-10: Step Load 1 ($V_{IN} = 12V$).

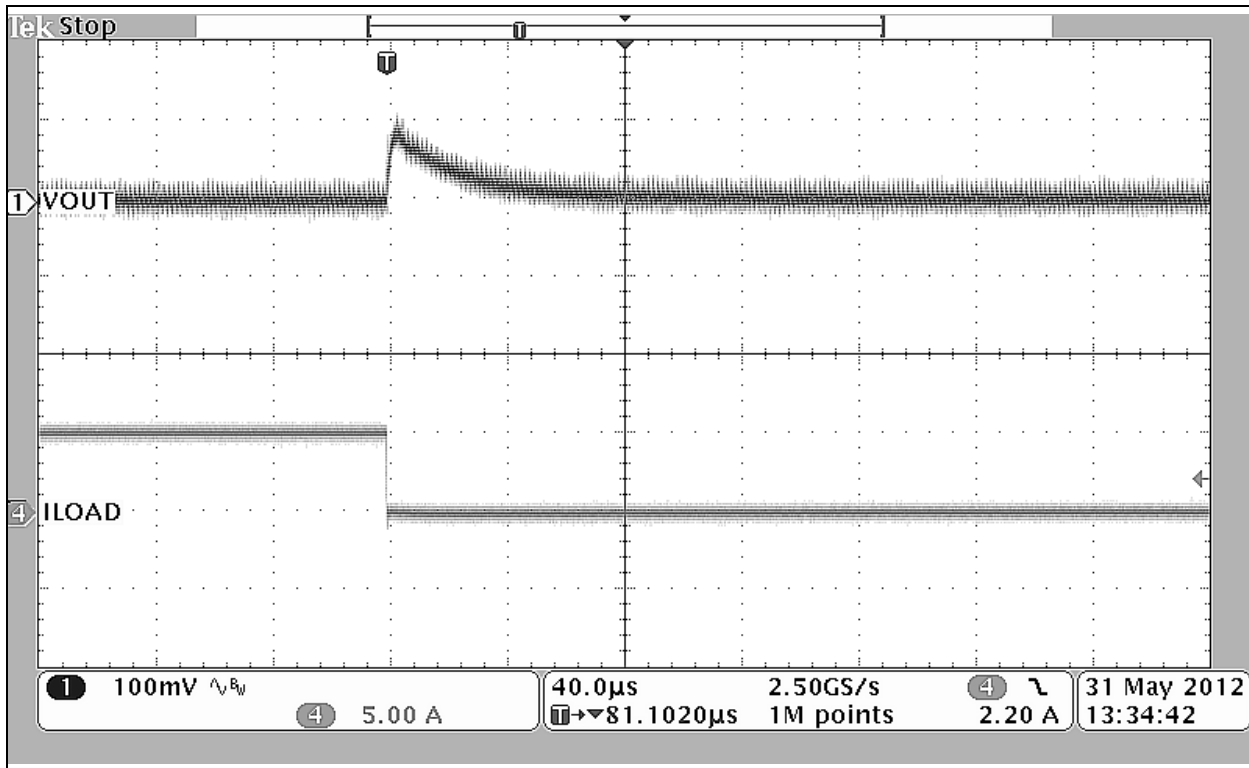

FIGURE C-11: Step Load 2 ($V_{IN} = 12V$).

Typical Performance Data, Curves and Waveforms

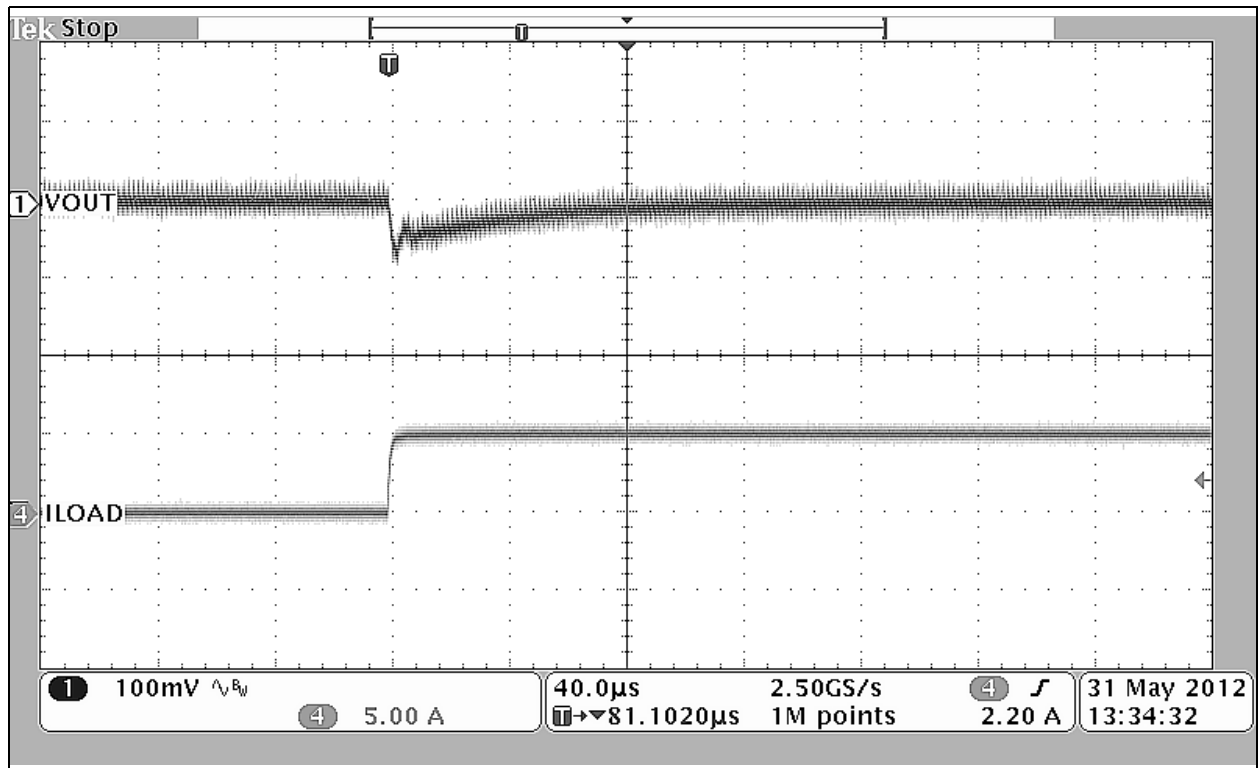

FIGURE C-12: Step Load 3 ($V_{IN} = 12V$).

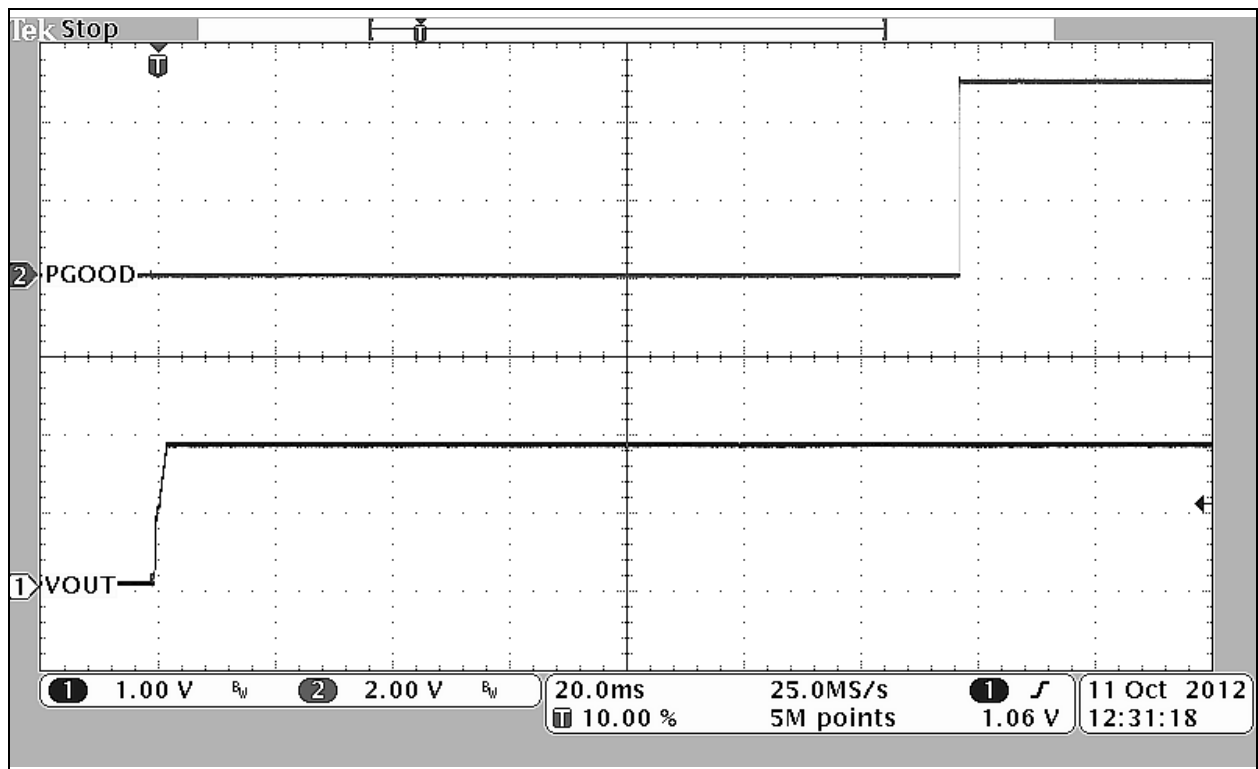

FIGURE C-13: Power Good Signal (PGOOD).

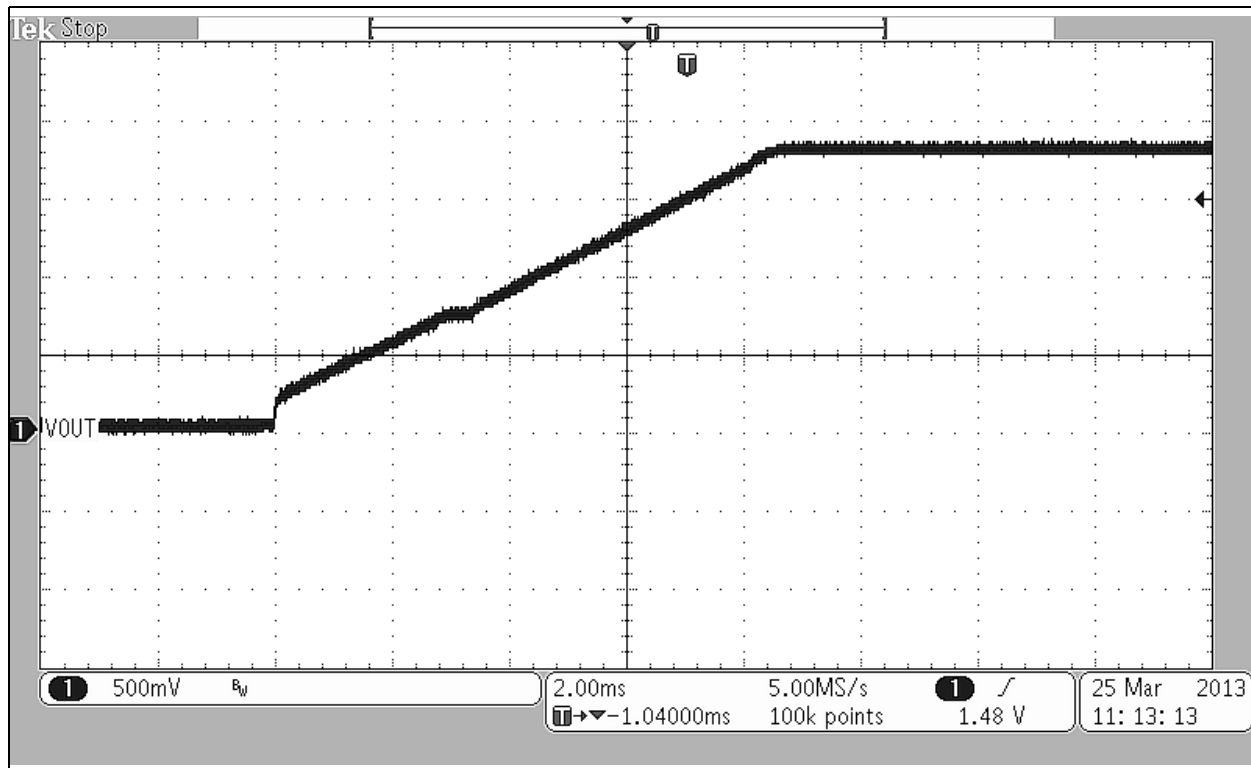

FIGURE C-14: Soft Start.

Typical Performance Data, Curves and Waveforms

NOTES:



MICROCHIP

Worldwide Sales and Service

AMERICAS

Corporate Office
2355 West Chandler Blvd.
Chandler, AZ 85224-6199
Tel: 480-792-7200
Fax: 480-792-7277
Technical Support:
<http://www.microchip.com/support>
Web Address:
www.microchip.com

Atlanta
Duluth, GA
Tel: 678-957-9614
Fax: 678-957-1455

Boston
Westborough, MA
Tel: 774-760-0087
Fax: 774-760-0088

Chicago
Itasca, IL
Tel: 630-285-0071
Fax: 630-285-0075

Cleveland
Independence, OH
Tel: 216-447-0464
Fax: 216-447-0643

Dallas
Addison, TX
Tel: 972-818-7423
Fax: 972-818-2924

Detroit
Farmington Hills, MI
Tel: 248-538-2250
Fax: 248-538-2260

Indianapolis
Noblesville, IN
Tel: 317-773-8323
Fax: 317-773-5453

Los Angeles
Mission Viejo, CA
Tel: 949-462-9523
Fax: 949-462-9608

Santa Clara
Santa Clara, CA
Tel: 408-961-6444
Fax: 408-961-6445

Toronto
Mississauga, Ontario,
Canada
Tel: 905-673-0699
Fax: 905-673-6509

ASIA/PACIFIC

Asia Pacific Office
Suites 3707-14, 37th Floor
Tower 6, The Gateway
Harbour City, Kowloon
Hong Kong
Tel: 852-2401-1200
Fax: 852-2401-3431

Australia - Sydney
Tel: 61-2-9868-6733
Fax: 61-2-9868-6755

China - Beijing
Tel: 86-10-8569-7000
Fax: 86-10-8528-2104

China - Chengdu
Tel: 86-28-8665-5511
Fax: 86-28-8665-7889

China - Chongqing
Tel: 86-23-8980-9588
Fax: 86-23-8980-9500

China - Hangzhou
Tel: 86-571-2819-3187
Fax: 86-571-2819-3189

China - Hong Kong SAR
Tel: 852-2943-5100
Fax: 852-2401-3431

China - Nanjing
Tel: 86-25-8473-2460
Fax: 86-25-8473-2470

China - Qingdao
Tel: 86-532-8502-7355
Fax: 86-532-8502-7205

China - Shanghai
Tel: 86-21-5407-5533
Fax: 86-21-5407-5066

China - Shenyang
Tel: 86-24-2334-2829
Fax: 86-24-2334-2393

China - Shenzhen
Tel: 86-755-8864-2200
Fax: 86-755-8203-1760

China - Wuhan
Tel: 86-27-5980-5300
Fax: 86-27-5980-5118

China - Xian
Tel: 86-29-8833-7252
Fax: 86-29-8833-7256

China - Xiamen
Tel: 86-592-2388138
Fax: 86-592-2388130

China - Zhuhai
Tel: 86-756-3210040
Fax: 86-756-3210049

ASIA/PACIFIC

India - Bangalore
Tel: 91-80-3090-4444
Fax: 91-80-3090-4123

India - New Delhi
Tel: 91-11-4160-8631
Fax: 91-11-4160-8632

India - Pune
Tel: 91-20-2566-1512
Fax: 91-20-2566-1513

Japan - Osaka
Tel: 81-6-6152-7160
Fax: 81-6-6152-9310

Japan - Tokyo
Tel: 81-3-6880-3770
Fax: 81-3-6880-3771

Korea - Daegu
Tel: 82-53-744-4301
Fax: 82-53-744-4302

Korea - Seoul
Tel: 82-2-554-7200
Fax: 82-2-558-5932 or
82-2-558-5934

Malaysia - Kuala Lumpur
Tel: 60-3-6201-9857
Fax: 60-3-6201-9859

Malaysia - Penang
Tel: 60-4-227-8870
Fax: 60-4-227-4068

Philippines - Manila
Tel: 63-2-634-9065
Fax: 63-2-634-9069

Singapore
Tel: 65-6334-8870
Fax: 65-6334-8850

Taiwan - Hsin Chu
Tel: 886-3-5778-366
Fax: 886-3-5770-955

Taiwan - Kaohsiung
Tel: 886-7-213-7828
Fax: 886-7-330-9305

Taiwan - Taipei
Tel: 886-2-2508-8600
Fax: 886-2-2508-0102

Thailand - Bangkok
Tel: 66-2-694-1351
Fax: 66-2-694-1350

EUROPE

Austria - Wels
Tel: 43-7242-2244-39
Fax: 43-7242-2244-393

Denmark - Copenhagen
Tel: 45-4450-2828
Fax: 45-4485-2829

France - Paris
Tel: 33-1-69-53-63-20
Fax: 33-1-69-30-90-79

Germany - Munich
Tel: 49-89-627-144-0
Fax: 49-89-627-144-44

Italy - Milan
Tel: 39-0331-742611
Fax: 39-0331-466781

Netherlands - Drunen
Tel: 31-416-690399
Fax: 31-416-690340

Spain - Madrid
Tel: 34-91-708-08-90
Fax: 34-91-708-08-91

UK - Wokingham
Tel: 44-118-921-5869
Fax: 44-118-921-5820

11/29/12