



MICROCHIP

HV9805
230V_{AC} Off-Line LED Driver
Evaluation Board
User's Guide

Note the following details of the code protection feature on Microchip devices:

- Microchip products meet the specification contained in their particular Microchip Data Sheet.
- Microchip believes that its family of products is one of the most secure families of its kind on the market today, when used in the intended manner and under normal conditions.
- There are dishonest and possibly illegal methods used to breach the code protection feature. All of these methods, to our knowledge, require using the Microchip products in a manner outside the operating specifications contained in Microchip's Data Sheets. Most likely, the person doing so is engaged in theft of intellectual property.
- Microchip is willing to work with the customer who is concerned about the integrity of their code.
- Neither Microchip nor any other semiconductor manufacturer can guarantee the security of their code. Code protection does not mean that we are guaranteeing the product as "unbreakable."

Code protection is constantly evolving. We at Microchip are committed to continuously improving the code protection features of our products. Attempts to break Microchip's code protection feature may be a violation of the Digital Millennium Copyright Act. If such acts allow unauthorized access to your software or other copyrighted work, you may have a right to sue for relief under that Act.

Information contained in this publication regarding device applications and the like is provided only for your convenience and may be superseded by updates. It is your responsibility to ensure that your application meets with your specifications. MICROCHIP MAKES NO REPRESENTATIONS OR WARRANTIES OF ANY KIND WHETHER EXPRESS OR IMPLIED, WRITTEN OR ORAL, STATUTORY OR OTHERWISE, RELATED TO THE INFORMATION, INCLUDING BUT NOT LIMITED TO ITS CONDITION, QUALITY, PERFORMANCE, MERCHANTABILITY OR FITNESS FOR PURPOSE. Microchip disclaims all liability arising from this information and its use. Use of Microchip devices in life support and/or safety applications is entirely at the buyer's risk, and the buyer agrees to defend, indemnify and hold harmless Microchip from any and all damages, claims, suits, or expenses resulting from such use. No licenses are conveyed, implicitly or otherwise, under any Microchip intellectual property rights.

Trademarks

The Microchip name and logo, the Microchip logo, dsPIC, FlashFlex, flexPWR, JukeBlox, KEELOQ, KEELOQ logo, Kleer, LANCheck, MediaLB, MOST, MOST logo, MPLAB, OptoLyzer, PIC, PICSTART, PIC³² logo, RightTouch, SpyNIC, SST, SST Logo, SuperFlash and UNI/O are registered trademarks of Microchip Technology Incorporated in the U.S.A. and other countries.

The Embedded Control Solutions Company and mTouch are registered trademarks of Microchip Technology Incorporated in the U.S.A.

Analog-for-the-Digital Age, BodyCom, chipKIT, chipKIT logo, CodeGuard, dsPICDEM, dsPICDEM.net, ECAN, In-Circuit Serial Programming, ICSP, Inter-Chip Connectivity, KleerNet, KleerNet logo, MiWi, MPASM, MPF, MPLAB Certified logo, MPLIB, MPLINK, MultiTRAK, NetDetach, Omniscient Code Generation, PICDEM, PICDEM.net, PICkit, PICtail, RightTouch logo, REAL ICE, SQI, Serial Quad I/O, Total Endurance, TSHARC, USBCheck, VariSense, ViewSpan, WiperLock, Wireless DNA, and ZENA are trademarks of Microchip Technology Incorporated in the U.S.A. and other countries.

SQTP is a service mark of Microchip Technology Incorporated in the U.S.A.

Silicon Storage Technology is a registered trademark of Microchip Technology Inc. in other countries.

GestIC is a registered trademarks of Microchip Technology Germany II GmbH & Co. KG, a subsidiary of Microchip Technology Inc., in other countries.

All other trademarks mentioned herein are property of their respective companies.

© 2015, Microchip Technology Incorporated, Printed in the U.S.A., All Rights Reserved.

ISBN: 978-1-63277-175-9

**QUALITY MANAGEMENT SYSTEM
CERTIFIED BY DNV
= ISO/TS 16949 =**

Microchip received ISO/TS-16949:2009 certification for its worldwide headquarters, design and wafer fabrication facilities in Chandler and Tempe, Arizona; Gresham, Oregon and design centers in California and India. The Company's quality system processes and procedures are for its PIC[®] MCUs and dsPIC[®] DSCs, KEELOQ[®] code hopping devices, Serial EEPROMs, microperipherals, nonvolatile memory and analog products. In addition, Microchip's quality system for the design and manufacture of development systems is ISO 9001:2000 certified.

HV9805 230V_{AC} Off-Line LED Driver Evaluation Board User's Guide

Object of Declaration: HV9805 230V_{AC} Off-Line LED Driver Evaluation Board

EU Declaration of Conformity

Manufacturer: Microchip Technology Inc.
2355 W. Chandler Blvd.
Chandler, Arizona, 85224-6199
USA

This declaration of conformity is issued by the manufacturer.

The development/evaluation tool is designed to be used for research and development in a laboratory environment. This development/evaluation tool is not a Finished Appliance, nor is it intended for incorporation into Finished Appliances that are made commercially available as single functional units to end users under EU EMC Directive 2004/108/EC and as supported by the European Commission's Guide for the EMC Directive 2004/108/EC (8th February 2010).

This development/evaluation tool complies with EU RoHS2 Directive 2011/65/EU.

This development/evaluation tool, when incorporating wireless and radio-telecom functionality, is in compliance with the essential requirement and other relevant provisions of the R&TTE Directive 1999/5/EC and the FCC rules as stated in the declaration of conformity provided in the module datasheet and the module product page available at www.microchip.com.

For information regarding the exclusive, limited warranties applicable to Microchip products, please see Microchip's standard terms and conditions of sale, which are printed on our sales documentation and available at www.microchip.com.

Signed for and on behalf of Microchip Technology Inc. at Chandler, Arizona, USA

Derek Carlson
VP Development Tools

12-Sep-14
Date

NOTES:

Table of Contents

Preface	7
Introduction.....	7
Document Layout	7
Conventions Used in this Guide	8
Recommended Reading.....	9
The Microchip Web Site	9
Customer Support	9
Revision History	9
Chapter 1. Product Overview	
1.1 Introduction	11
1.2 HV9805 Device Short Overview	11
1.2.1 HV9805 Device Key Features	12
1.2.2 Two-Stage Topology:	13
1.3 What is the HV9805 230V _{AC} Off-Line LED Driver Evaluation Board?	14
1.4 What does the HV9805 230V _{AC} Off-Line LED Driver Evaluation Board Include?	14
Chapter 2. Installation and Operation	
2.1 Introduction	15
2.1.1 Board Features	15
2.2 Getting Started	15
2.2.1 Powering the HV9805 230V _{AC} Off-Line LED Driver Evaluation Board	15
2.3 How does the HV9805 230V _{AC} Off-Line LED Driver Evaluation Board Work?	16
2.4 Board Testing, Test Points Waveforms and Overall Measured Parameters	18
2.4.1 Board Testing	18
2.4.2 Test Points Waveforms	18
2.4.3 Overall Measured Parameters	23
Appendix A. Schematic and Layouts	
A.1 Introduction	27
A.2 Board – Schematic	28
A.3 Board – Top Silk	29
A.4 Board – Top Copper	29
A.5 Board – Bottom Copper	30
Appendix B. Bill of Materials (BOM)	
Worldwide Sales and Service	34

NOTES:



HV9805 230V_{AC} OFF-LINE LED DRIVER EVALUATION BOARD USER'S GUIDE

Preface

NOTICE TO CUSTOMERS

All documentation becomes dated, and this manual is no exception. Microchip tools and documentation are constantly evolving to meet customer needs, so some actual dialogs and/or tool descriptions may differ from those in this document. Please refer to our web site (www.microchip.com) to obtain the latest documentation available.

Documents are identified with a “DS” number. This number is located on the bottom of each page, in front of the page number. The numbering convention for the DS number is “DSXXXXXXXXA”, where “XXXXXXXX” is the document number and “A” is the revision level of the document.

For the most up-to-date information on development tools, see the MPLAB® IDE online help. Select the Help menu, and then Topics to open a list of available online help files.

INTRODUCTION

This chapter contains general information that will be useful to know before using the HV9805 230V_{AC} Off-Line LED Driver Evaluation Board. Items discussed in this chapter include:

- Document Layout
- Conventions Used in this Guide
- Recommended Reading
- The Microchip Web Site
- Customer Support
- Revision History

DOCUMENT LAYOUT

This document describes how to use the HV9805 230V_{AC} Off-Line LED Driver Evaluation Board as a development tool for specific applications driven by HV9805. The document is organized as follows:

- **Chapter 1. “Product Overview”** – Important information about the HV9805 230V_{AC} Off-Line LED Driver Evaluation Board.
- **Chapter 2. “Installation and Operation”** – Includes instructions on how to get started with this user's guide and a description of the user's guide.
- **Appendix A. “Schematic and Layouts”** – Shows the schematic and layout diagrams for the HV9805 230V_{AC} Off-Line LED Driver Evaluation Board.
- **Appendix B. “Bill of Materials (BOM)”** – Lists the parts used to build the HV9805 230V_{AC} Off-Line LED Driver Evaluation Board.

CONVENTIONS USED IN THIS GUIDE

This manual uses the following documentation conventions:

DOCUMENTATION CONVENTIONS

Description	Represents	Examples
Arial font:		
Italic characters	Referenced books	<i>MPLAB[®] IDE User's Guide</i>
	Emphasized text	...is the <i>only</i> compiler...
Initial caps	A window	the Output window
	A dialog	the Settings dialog
	A menu selection	select Enable Programmer
Quotes	A field name in a window or dialog	"Save project before build"
Underlined, italic text with right angle bracket	A menu path	<u><i>File>Save</i></u>
Bold characters	A dialog button	Click OK
	A tab	Click the Power tab
N'Rnnnn	A number in verilog format, where N is the total number of digits, R is the radix and n is a digit.	4'b0010, 2'hF1
Text in angle brackets < >	A key on the keyboard	Press <Enter>, <F1>
Courier New font:		
Plain Courier New	Sample source code	#define START
	Filenames	autoexec.bat
	File paths	c:\mcc18\h
	Keywords	_asm, _endasm, static
	Command-line options	-Opa+, -Opa-
	Bit values	0, 1
	Constants	0xFF, 'A'
Italic Courier New	A variable argument	<i>file.o</i> , where <i>file</i> can be any valid filename
Square brackets []	Optional arguments	mcc18 [options] <i>file</i> [options]
Curly brackets and pipe character: { }	Choice of mutually exclusive arguments; an OR selection	errorlevel {0 1}
Ellipses...	Replaces repeated text	var_name [, var_name...]
	Represents code supplied by user	void main (void) { ... }

RECOMMENDED READING

This user's guide describes how to use HV9805 230V_{AC} Off-Line LED Driver Evaluation Board. Other useful documents are listed below. The following Microchip documents are available and recommended as supplemental reference resources.

- **HV9805 Data Sheet – “Off-Line LED Driver with True DC Output Current” (DS20005374).**

THE MICROCHIP WEB SITE

Microchip provides online support via our web site at www.microchip.com. This web site is used as a means to make files and information easily available to customers. Accessible by using your favorite Internet browser, the web site contains the following information:

- **Product Support** – Data sheets and errata, application notes and sample programs, design resources, user's guides and hardware support documents, latest software releases and archived software
- **General Technical Support** – Frequently Asked Questions (FAQs), technical support requests, online discussion groups, Microchip consultant program member listing
- **Business of Microchip** – Product selector and ordering guides, latest Microchip press releases, listing of seminars and events, listings of Microchip sales offices, distributors and factory representatives

CUSTOMER SUPPORT

Users of Microchip products can receive assistance through several channels:

- Distributor or Representative
- Local Sales Office
- Field Application Engineer (FAE)
- Technical Support

Customers should contact their distributor, representative or field application engineer (FAE) for support. Local sales offices are also available to help customers. A listing of sales offices and locations is included in the back of this document.

Technical support is available through the web site at:

<http://www.microchip.com/support>.

REVISION HISTORY

Revision A (March 2015)

This is the initial release of this document.

NOTES:

Chapter 1. Product Overview

1.1 INTRODUCTION

This chapter provides an overview of the HV9805 230V_{AC} Off-Line LED Driver Evaluation Board and covers the following topics:

- HV9805 Device Short Overview
- What is the HV9805 230VAC Off-Line LED Driver Evaluation Board?
- What does the HV9805 230VAC Off-Line LED Driver Evaluation Board Include?

1.2 HV9805 DEVICE SHORT OVERVIEW

The HV9805 driver integrated circuit (IC) is targeted at general light-emitting diode (LED) lighting products, such as LED lamps and LED lighting fixtures with a maximum power rating of about 25W at 120V_{AC}, and about 50W at 230V_{AC}.

A two-stage topology provides true constant-current drive for the LED load while drawing mains power with high power factor. The first stage, a boundary conduction mode boost converter, transfers power from the AC line to a second stage, with high power factor and high efficiency.

The second stage, a linear regulator arranged for operation with low overhead voltage, transfers power from the first stage to the LED load with true constant current and protects the LED load from overvoltage that may pass from mains to the output of the first stage.

The IC is particularly geared to drive a high-voltage LED load. An LED load arranged as a high-voltage load is capable of offering cost advantages in terms of heat management and optics.

The boost converter employs a cascode switch for high-speed switching and convenient generation of the V_{DD} supply. The control device of the cascode switch is integrated into the HV9805 and is rated for a peak current of 0.7A.

The current for powering the V_{DD} supply is derived by way of an internal connection to the cascode switch.

Applications which require lower load voltage can be accommodated by adapting the first stage to the SEPIC topology.

1.2.1 HV9805 Device Key Features

- Provides True DC Light and Protects Load from Line Voltage Transients
- Driver Topology Includes:
 - Boundary Conduction Mode (BCM) boost converter with power factor correction
 - a) High power factor (0.98 typical)
 - b) High efficiency (90% typical)
 - Linear post-regulator with low overhead voltage
 - a) Zero LED current/brightness ripple
 - b) Overvoltage protection for LEDs
 - c) High efficiency
 - d) $\pm 4\%$ temperature reference accuracy
- Simple V_{DD} Supply:
 - No auxiliary winding required
- Boost Converter Cascode Switch:
 - Internal switch rated at 700 mA peak
 - Supports up to 25W at 120V_{AC}
 - Supports up to 50W at 230V_{AC}
- Compatibility with SEPIC Topology for Low Output Voltage Applications
- Available Package: 10-Lead MSOP

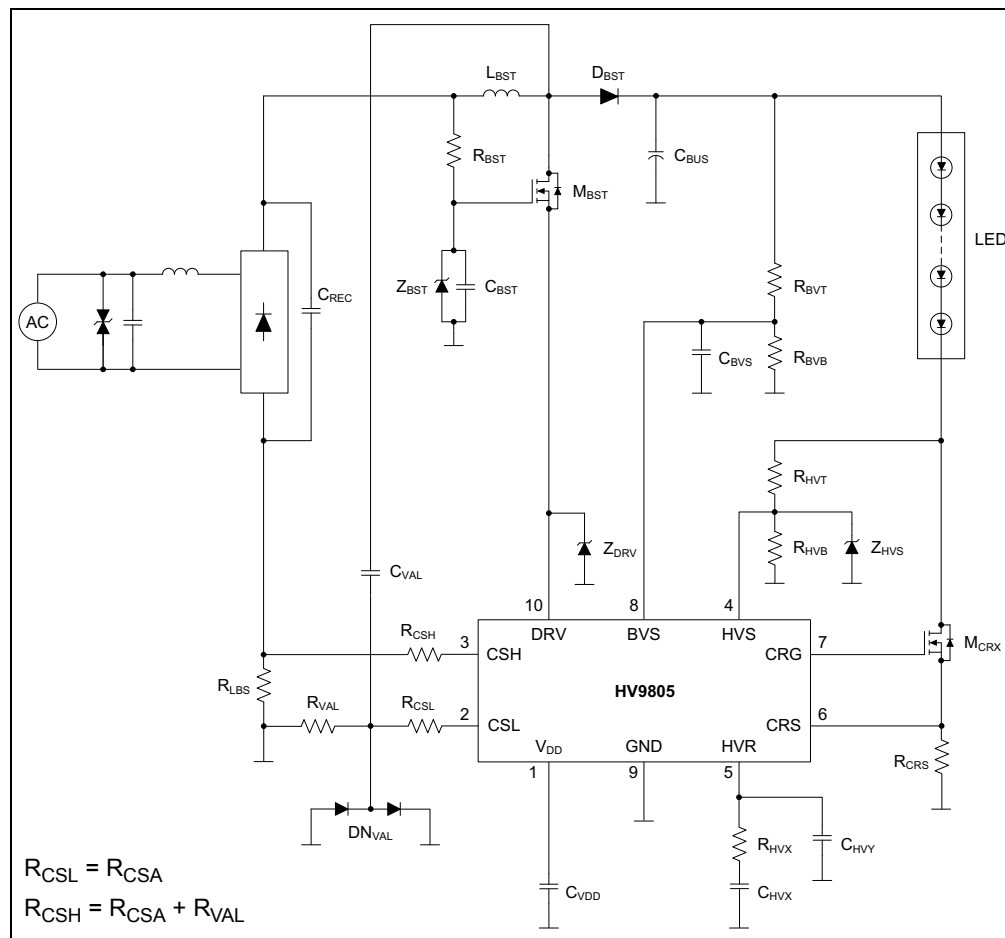

FIGURE 1-1: Typical HV9805 Off-Line LED Driver Circuit.

1.2.2 Two-Stage Topology:

The two-stage topology of the HV9805 device consists of:

- Boundary Conduction Mode (BCM) and Power Factor Correction (PFC) Boost Converter
- LED-Side Linear Regulator

1.2.2.1 FIRST STAGE: BCM PFC BOOST CONVERTER

- Produces a DC bus voltage V_{BUS} with high efficiency (95%) with 100 Hz (120 Hz) ripple and slow regulation (10 Hz BW)
- Direct connection of HV LEDs to the bus results in:
 - relatively large LED current ripple
 - direct exposure of LEDs to line voltage transients

1.2.2.2 SECOND STAGE: LINEAR REGULATOR IN SERIES WITH LED LOAD

- Arranged as a constant-current regulator with fast response (>1 kHz)
- LED current is true DC
- LEDs are protected from line overvoltage
- Linear regulator lowers efficiency about 2%
- Continuous Current Regulator (CCR) maintains the headroom voltage V_{HDR} at a small value (~ 6V)
- Uses smaller electrolytic capacitors possible (efficiency versus cost trade-off)
- Smooth DC LED current, CCR rejects the larger bus voltage ripple

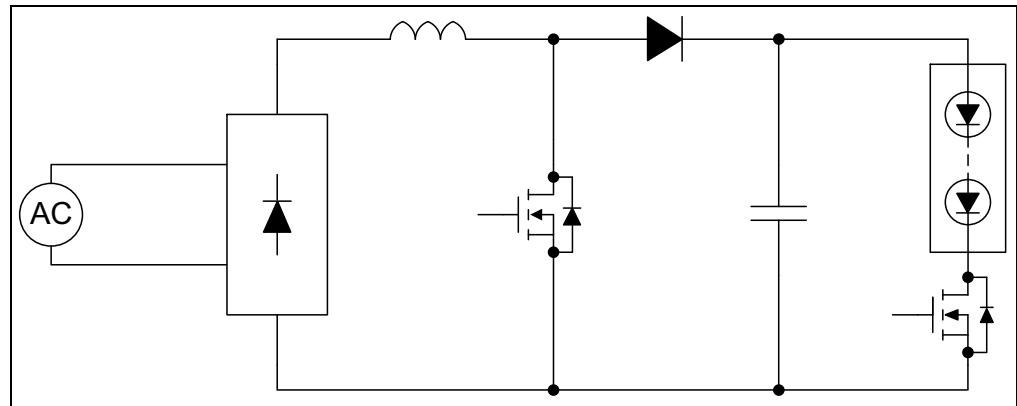

FIGURE 1-2: Principle Diagram Two-Stage Topology.

1.3 WHAT IS THE HV9805 230V_{AC} OFF-LINE LED DRIVER EVALUATION BOARD?

The HV9805 230V_{AC} Off-Line LED Driver Evaluation Board is used to evaluate and demonstrate Microchip Technology Inc.'s HV9805 device in the following topology:

- 420-430V output Boost Converter application followed by a LED-side linear current regulator, supplied from the mains 230V_{AC}, to drive a 130-150 LED string.

The HV9805 230V_{AC} Off-Line LED Driver Evaluation Board was developed to help engineers reduce the product design cycle time.

1.4 WHAT DOES THE HV9805 230V_{AC} OFF-LINE LED DRIVER EVALUATION BOARD INCLUDE?

The HV9805 230V_{AC} Off-Line LED Driver Evaluation Board kit includes:

- HV9805 230V_{AC} Off-Line LED Driver Evaluation Board (ADM00657)
- Information Sheet

Chapter 2. Installation and Operation

2.1 INTRODUCTION

The HV9805 control IC provides true current drive for LED lamps and fixtures by way of a simple two-stage power supply topology comprised of a boundary mode (BCM) boost converter and a linear constant-current regulator. The constant-current regulator removes the influence of bus voltage variation on the LED load operating and current, and protects the LED load from potentially damaging transients that may originate from mains overvoltage events. The IC is targeted at designs operating at a single line voltage, such as 120V_{AC} or 230V_{AC}, and thus, does not support designs for the universal input voltage range. The efficiency of the constant-current regulator is maximized by minimizing the DC component of the headroom voltage.

The main sections of the application are presented in the following chapters.

2.1.1 Board Features

The HV9805 230V_{AC} Off-Line LED Driver Evaluation Board has the following features:

- Input Voltage: 230V_{AC} ±15%, at 50 Hz Typical
- Output Capability: up to 125 mA
- Efficiency: over 90%
- Pulse-Width Modulation (PWM) Operation: up to 135 kHz

2.2 GETTING STARTED

The HV9805 230V_{AC} Off-Line LED Driver Evaluation Board is fully assembled and tested to evaluate and demonstrate the HV9805 LED driver.

2.2.1 Powering the HV9805 230V_{AC} Off-Line LED Driver Evaluation Board

The board is connected directly to 230V_{AC}. A variable AC power supply is needed for testing and evaluation in the laboratory. The power supply requires an output capability of at least 1A and a voltage range of 100 to 280V_{AC}. This can be obtained from an autotransformer supplied from the mains or an electronic AC/AC power supply (for example, Chroma ATE Inc.'s 61500 series).

The power connectors are the following:

- The input connectors, J1 and J2, are placed on the left side of the board and marked 230V_{AC}, as shown in [Figure 2-1](#).
- The output connectors, J3 and J4, are called LED+ and LED- and are placed on the right side of the board.

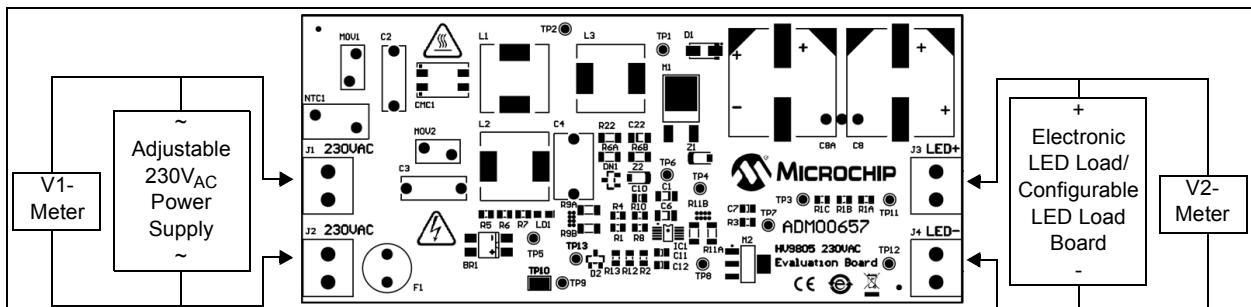

FIGURE 2-1: Connection Diagram.

To power the board, follow these steps:

1. Connect the power at terminals J1, 230V_{AC}~ and J2, 230V_{AC}~.
2. Connect a voltmeter and the LED string at J3 (V+ LED) and J4 (V- LED) connectors, as shown in [Figure 2-1](#). The LED string can be formed with 132 to 150 LED cells (3 LEDs in parallel), 80 mA SMD LED, 280 mW. An example is shown in [Figure 2-2](#).

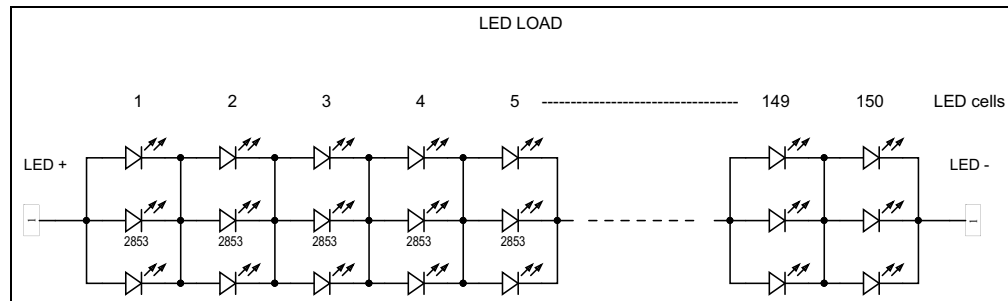

FIGURE 2-2: LED Load String Example.

2.3 HOW DOES THE HV9805 230V_{AC} OFF-LINE LED DRIVER EVALUATION BOARD WORK?

The board was designed to supply, by means of a common-mode filter, a rectifier; a boost converter followed by a linear regulator, both conducted by the HV9805 driver directly from the 230V_{AC} mains; and an LED load; with constant current also controlling the power factor. The topology used in this evaluation board is a Boundary Conduction Mode (BCM) boost converter followed by a linear current regulator on the LED side in order to assure true current and high efficiency.

The HV9805 device has the following regulators:

- The V_{DD} regulator, which is inside the chip (only the filter capacitor is outside)
- The LED current regulator
- The headroom voltage regulator
- The line current waveform regulator

The LED current can be programmed using [Equation 2-1](#).

EQUATION 2-1: SENSE RESISTORS RELATIONSHIP

$$V_{REF, CCR} = I_{LED} \times R_{CRS}$$

Where:

$$V_{REF, CCR} = 1.0V \text{ (at 100\% current level)}$$

$$I_{LED} = \text{LED current}$$

$$R_{CRS} = \text{Resistor's value is selected by the designer}$$

EXAMPLE 2-1:

If:	I_{LED}	=	90 mA
Then:	R_{CRS}	=	11.11Ω
Choose:	$R11A$	=	$R11B = 22\Omega = 2 \times R_{CRS}$

Installation and Operation

The headroom voltage is programmed to the desired level using [Equation 2-2](#).

EQUATION 2-2: THE DESIRED DC LEVEL OF HEADROOM VOLTAGE

$$V_{REF, HVR} = V_{HDC} \times K_{DIV}$$

$$K_{DIV} = \frac{R_{HVB}}{R_{HVB} + R_{HVT}}$$

Where:

$V_{REF, HVR}$	=	1.25V
V_{HDC}	=	DC level of the headroom voltage
K_{DIV}	=	Attenuation of the headroom voltage divider
R_{HVT}, R_{HVB}	=	Top and bottom resistor of the headroom voltage divider

EXAMPLE 2-2:

For:	V_{HDC}	=	7.5V
Then:	K_{DIV}	=	$1.25/7.5 = 0.166$
Therefore:	R_{HVT}/R_{HVB}	=	5.0
Then:	R_{HVB}	=	10 k Ω
Choose:	R_{HVT}	=	50 k Ω

The DC level of the bus voltage is regulated to be the total sum of the DC level of the headroom voltage and the operating voltage of the LED load, and will thereby vary during operation with changes in the forward voltage of the LED load.

EXAMPLE 2-3:

If a 140 LED string is used, a forward voltage drop of 3V on each LED is assumed. Then, the Bus Voltage level will be:

$$V_{DC} = 140 \times 3 + V_{HDC} = 420 + 7.5 = 427.5V_{DC}$$

Note: In order to have a good Valley detection, choose an LED string voltage 20-30V greater than the peak input voltage (which is usually 264V_{AC}). In this condition, the minimum LED load voltage is
 $V_{LED\ MIN} = 20 + 1.41 \times 264 = 392V_{DC}$

The power dissipation of the LED current regulator must be low, so the DC level of the headroom voltage (V_{HDC}) will be minimized, the dissipation being calculated using [Equation 2-3](#).

EQUATION 2-3: THE POWER DISSIPATION OF THE LED CURRENT REGULATOR

$$P_{DIS} = I_{LED} \times V_{HDC}$$

Where:

P_{DIS}	=	Power dissipation of the current LED regulator
I_{LED}	=	LED current
V_{HDC}	=	DC level of the headroom voltage
P_{DIS}	=	$0.090A \times 7.5V = 0.675W$

The output voltage of the control amplifier provides the on-time reference for the boost converter control circuitry, according to [Equation 2-4](#).

EQUATION 2-4: THE ON-TIME REFERENCE FOR THE BOOST CONVERTER CONTROL (T_{ON})

$$T_{ON} = K_{HVR} \times V_{HVR}$$

Where:

- T_{ON} = On-time reference signal from the headroom voltage regulator
- K_{HVR} = On-time modulator gain
- V_{HVR} = 5V
- K_{HVR} = 2.2 μ s/V
- T_{ON} = 5 \times 2.2 μ s = 11 μ s

2.4 BOARD TESTING, TEST POINTS WAVEFORMS AND OVERALL MEASURED PARAMETERS

2.4.1 Board Testing

To start testing the evaluation board, follow these steps:

1. Power the board at 230V_{AC}.
2. Check that the voltmeter indicates the LED load voltage (do not exceed 440V_{DC}).
3. With a power supply of 230V_{AC}, verify if the current regulated through the LED strings is about 90 mA (by means of an ampere-meter connected in series with the LEDs).

The following steps are possible if a variable AC power supply or an autotransformer is available:

4. Set the power supply to 190V_{AC} and verify if the output current on the LED side stays regulated (I_{OUT} ~90 mA).
5. Set the power supply to 270V_{AC} and verify if the output current on the LED side stays regulated (I_{OUT} ~90 mA). Also, check that the voltage stays regulated on V2 near the value 415V.

2.4.2 Test Points Waveforms

The board has several test points that help engineers to analyze the switch node's waveforms of HV9805 device output:

TABLE 2-1: TEST POINTS

Test Point	Description
TP1	Boost inductor (L3) voltage
TP2	Rectified line voltage V_{DC}
TP3	Bus voltage sense (BVS pin voltage)
TP4 (SW)	Voltage on switching node (DRV pin) of the HV9805 device
TP5	Inductor current sense voltage
TP6	V_{DD} voltage on IC (V_{DD} pin voltage), (6.5 to 8V)
TP7	Gate control voltage (CRG pin) of the linear regulator
TP8	LED current sense (CRS pin)
TP10	GND
TP11 – TP12	LED string voltage
TP13	High-voltage sense (HVS pin voltage)

The regulated headroom voltage is approximately 8V in order to reduce the losses on the linear regulator.

Installation and Operation

The signal waveforms from the significant points of the design are presented in Figures 2-3 – 2-11.

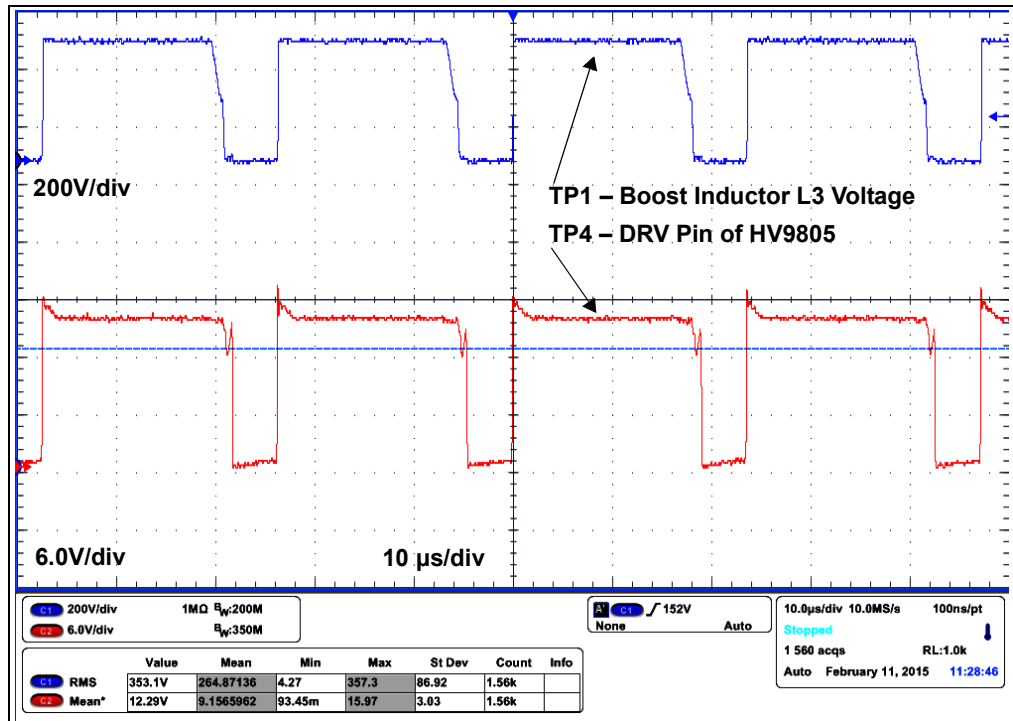

FIGURE 2-3: Boost Inductor Voltage (TP1) and DRV Pin Voltage (TP4), Working on the Lower Side of the Sinus Wave Input Voltage.

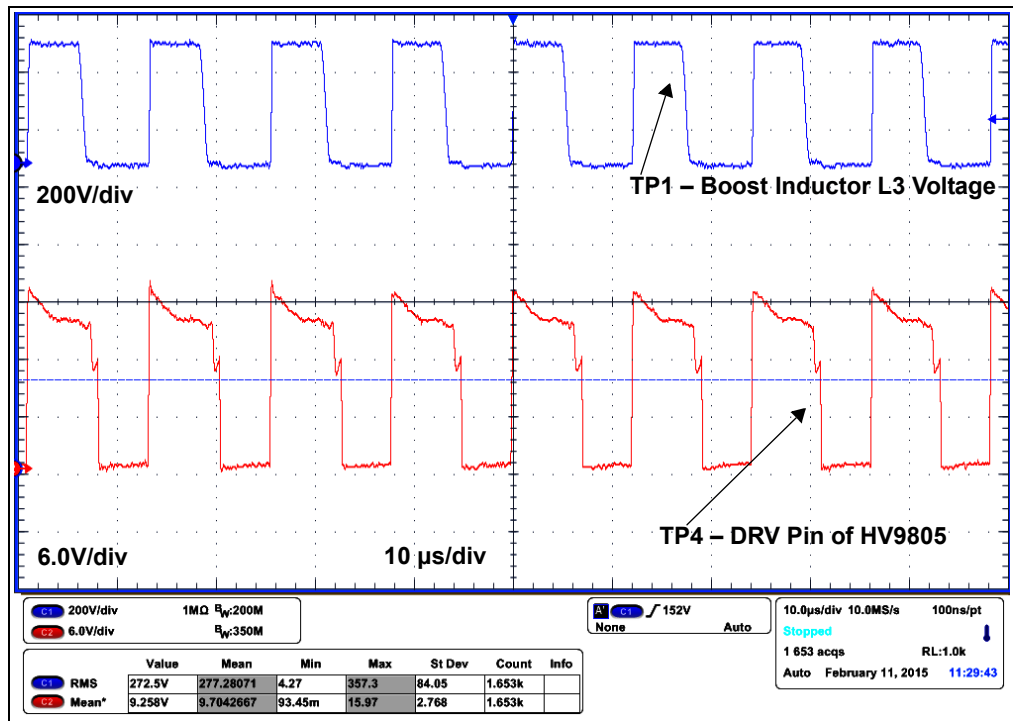

FIGURE 2-4: Boost Inductor Voltage (TP1) and DRV Pin Voltage (TP4), Working on the Upper Side of the Sinus Wave Input Voltage.

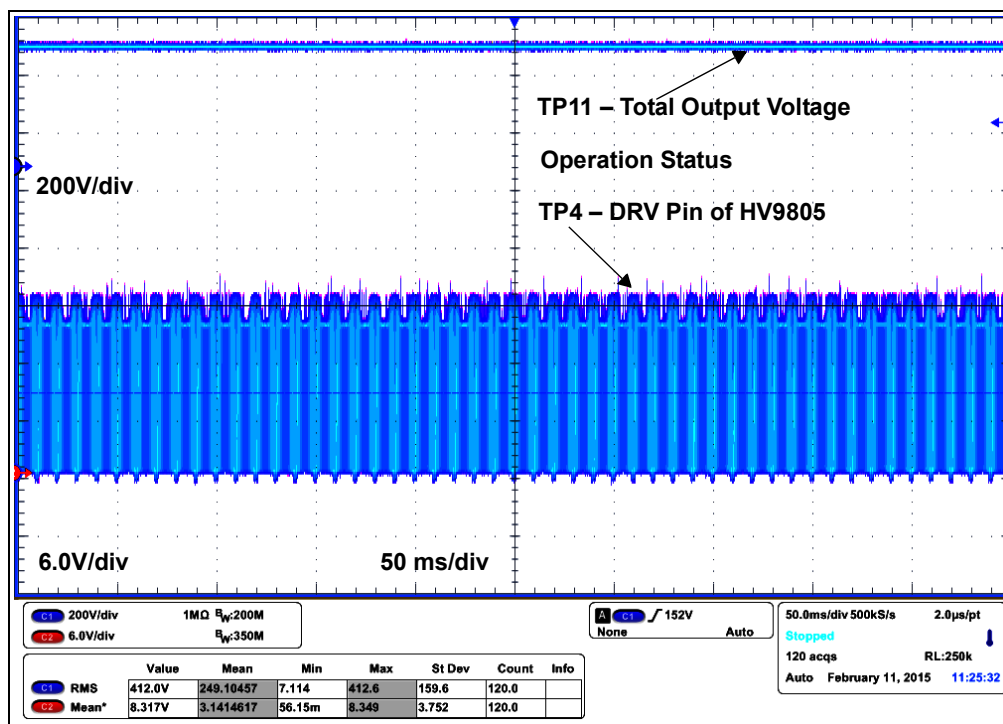

FIGURE 2-5: LED Load Voltage (TP12 – TP13) and DRV Pin Voltage (TP4) in Operation Mode.

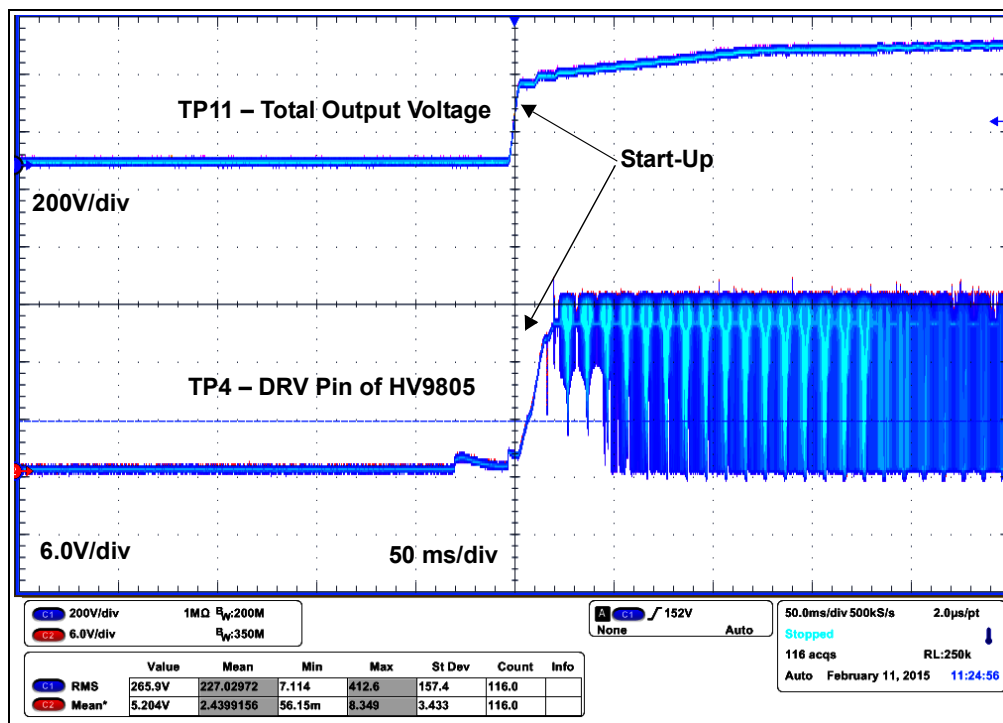

FIGURE 2-6: LED Load Voltage (TP12 – TP13) and DRV Pin Voltage (TP4) in Start-up Mode.

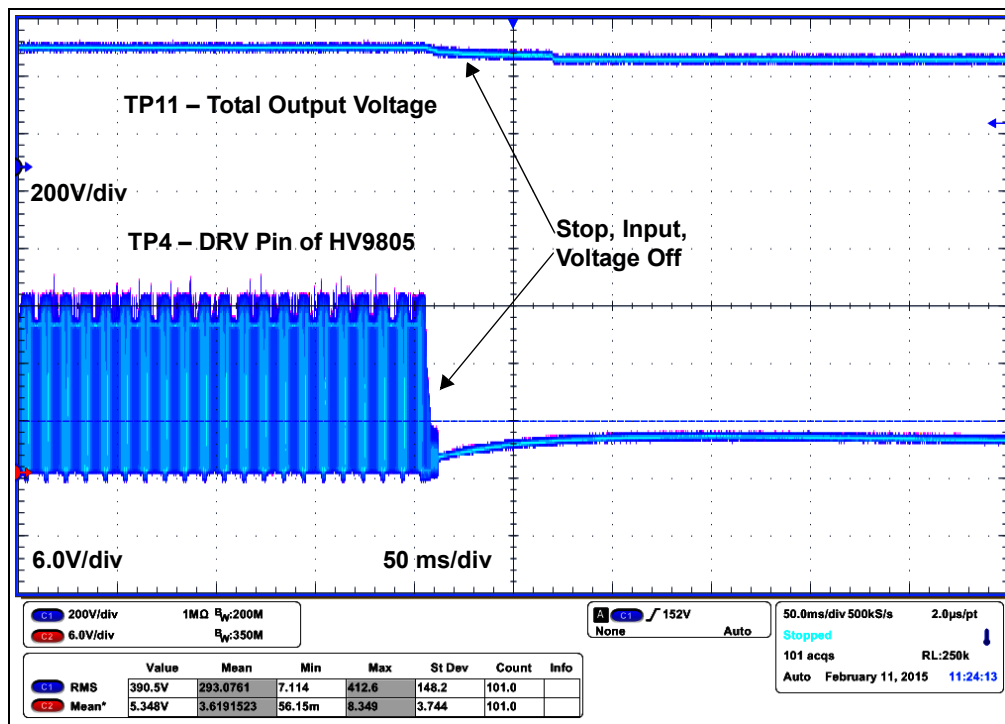

FIGURE 2-7: LED Load Voltage (TP12 – TP13) and DRV Pin Voltage (TP4) in Stop Mode.

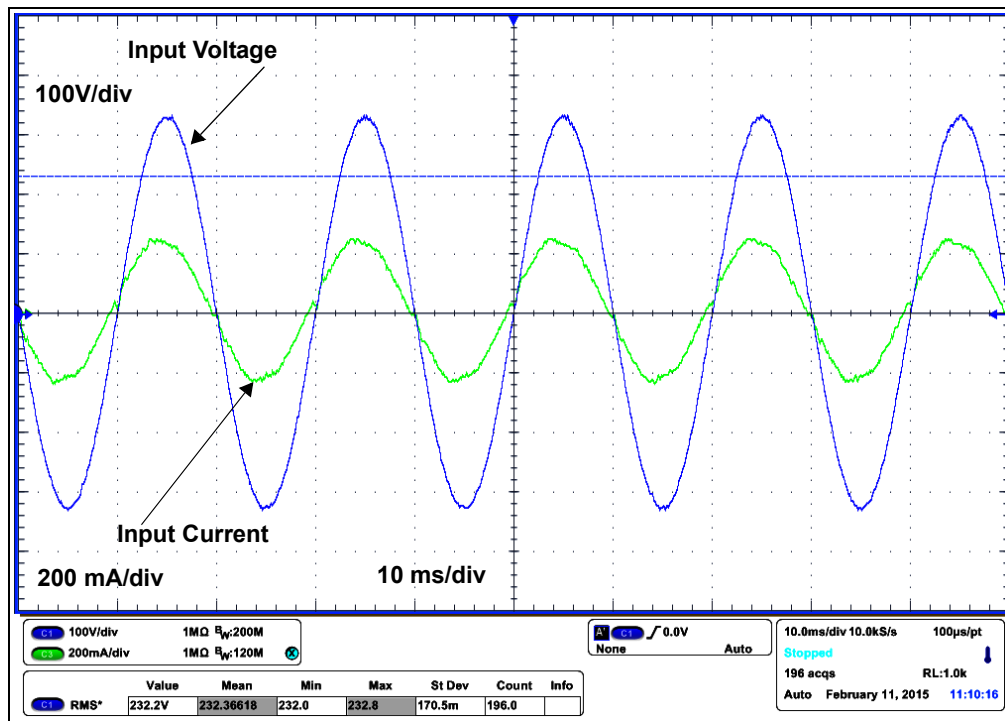

FIGURE 2-8: Input Voltage and Input Current, Phase Lock.

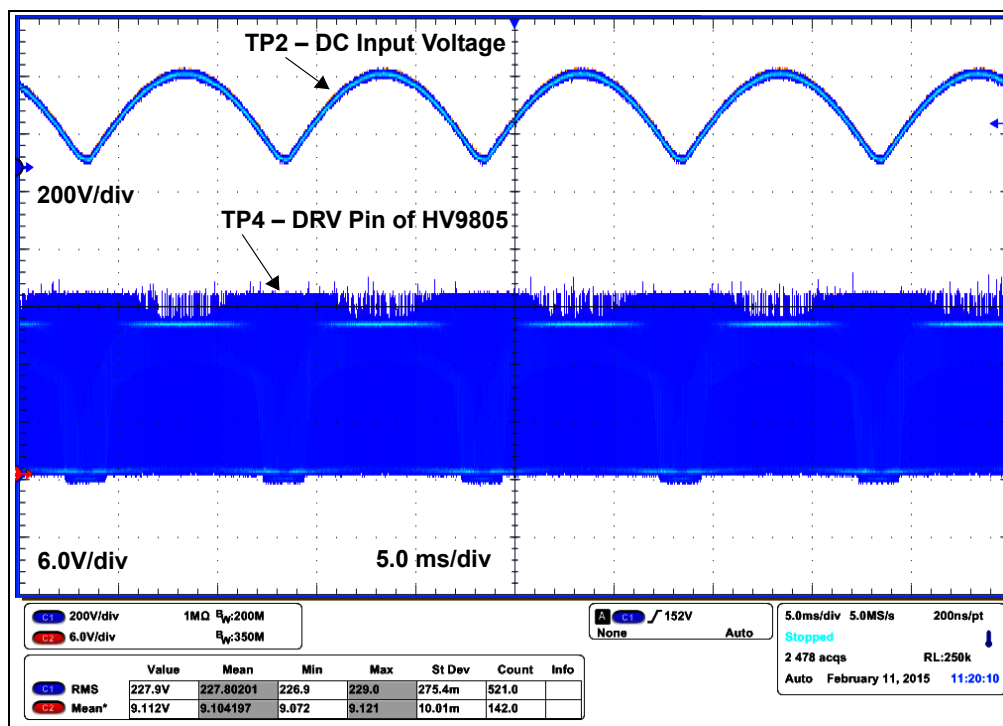

FIGURE 2-9: DC Line Voltage (TP2) and DRV Pin Voltage (TP4) in Operation Mode.

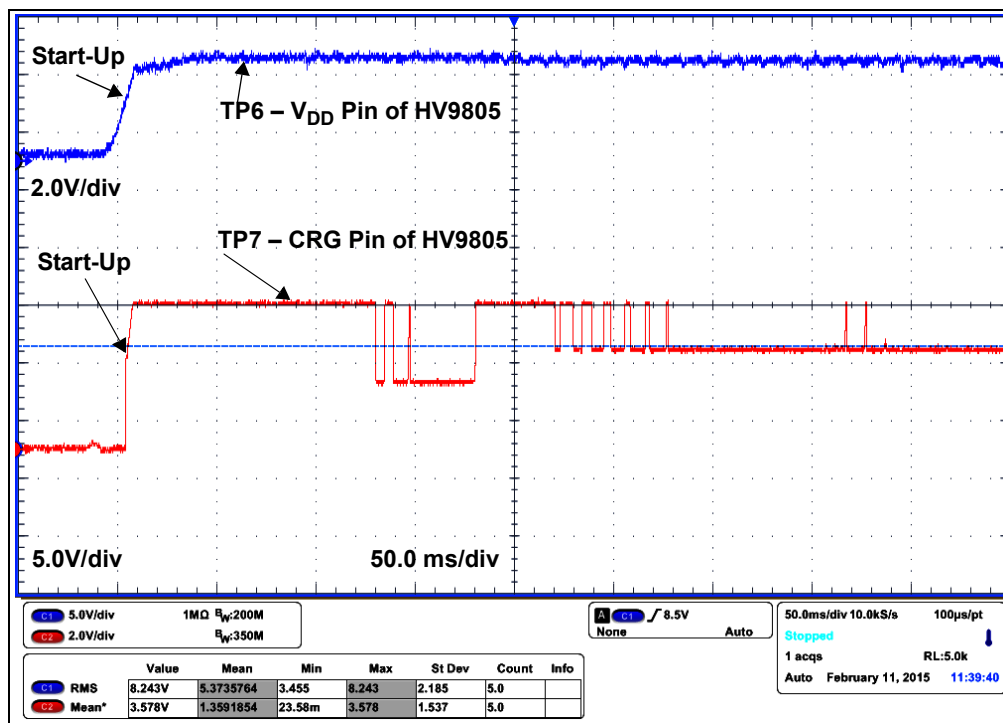

FIGURE 2-10: HV9805 Supply Voltage (V_{DD} pin, TP6) and Control Gate Voltage (TP7 CRG PIN) at Start-up Mode.

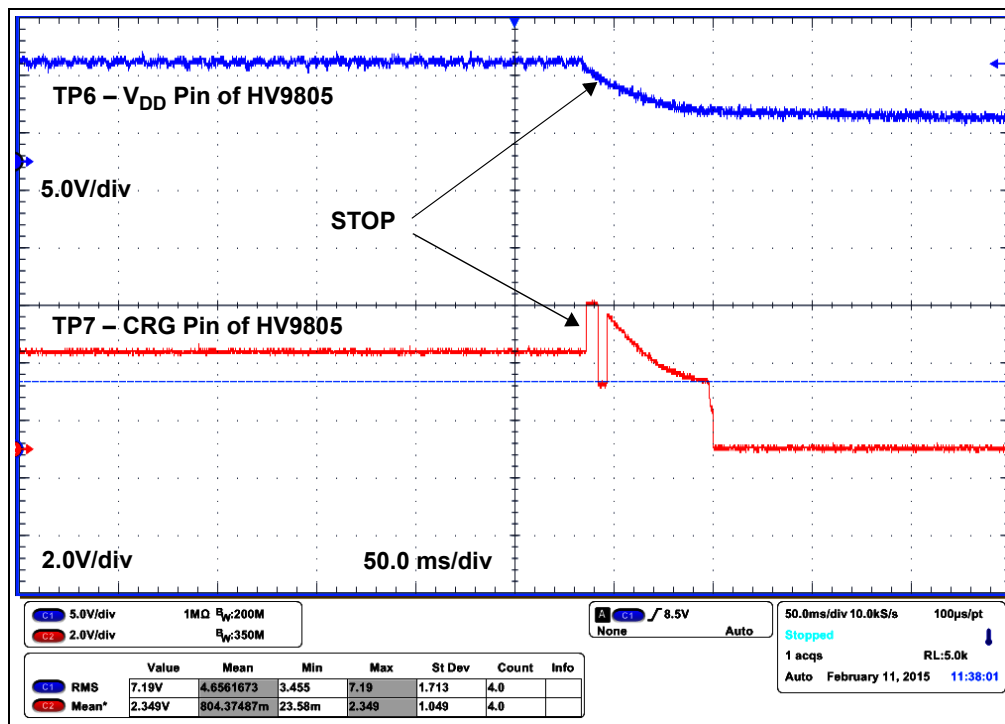

FIGURE 2-11: HV9805 Supply Voltage (V_{DD} pin, TP6) and Control Gate Voltage (TP7 CRG PIN) at Stop Mode.

2.4.3 Overall Measured Parameters

The overall parameters of the evaluation board are presented in the [Figures 2-12 – 2-16](#).

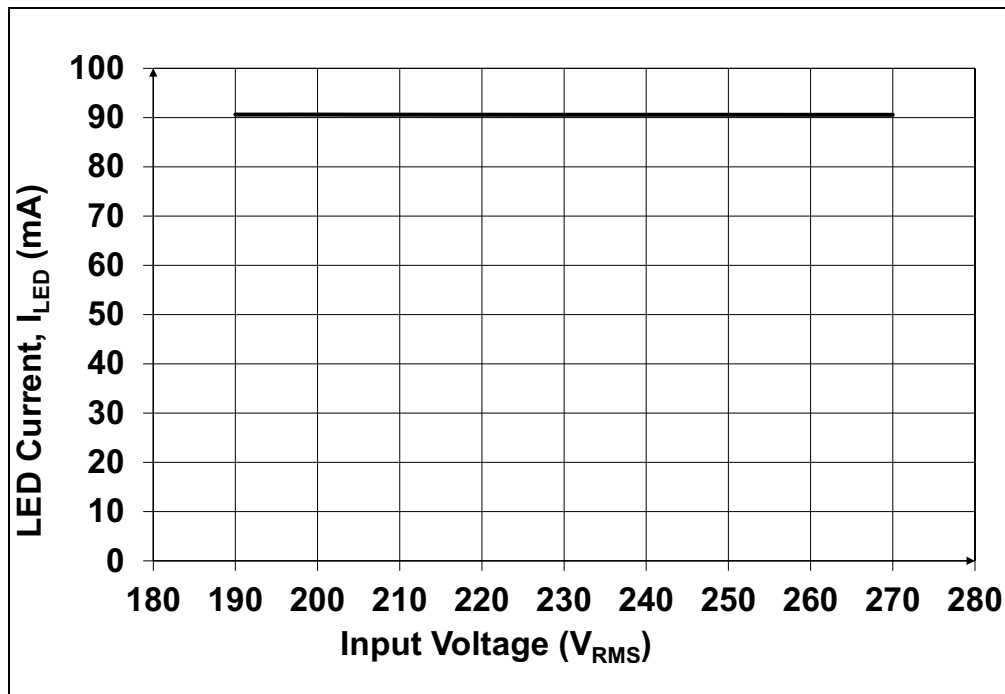

FIGURE 2-12: Variation of the LED Current Vs. Mains Input Voltage.

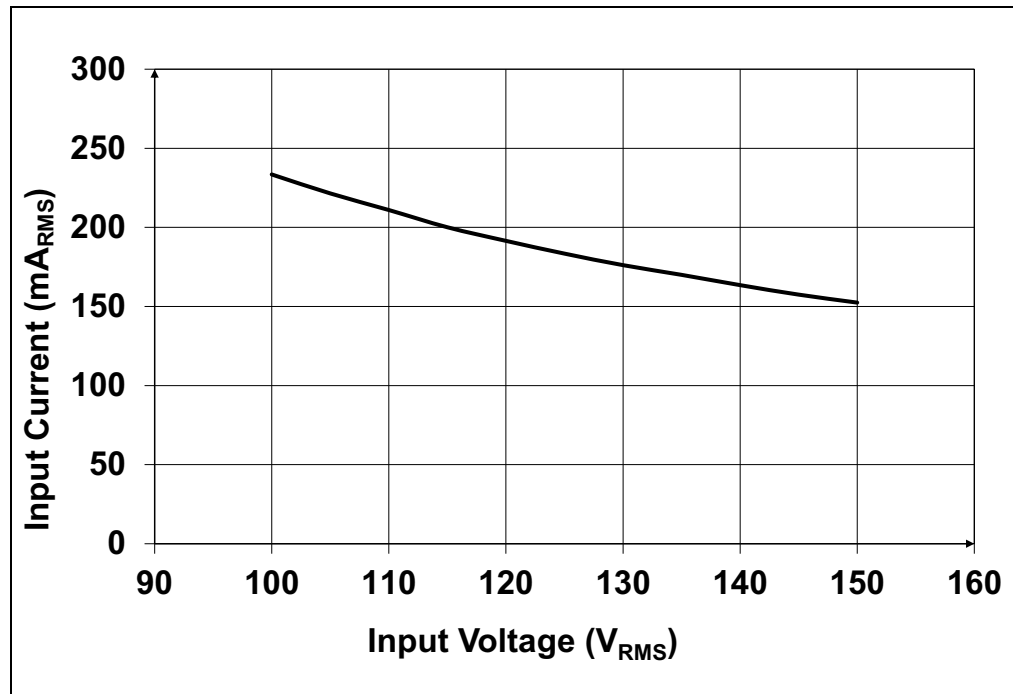

FIGURE 2-13: Variation of Input Current and Input Voltage.

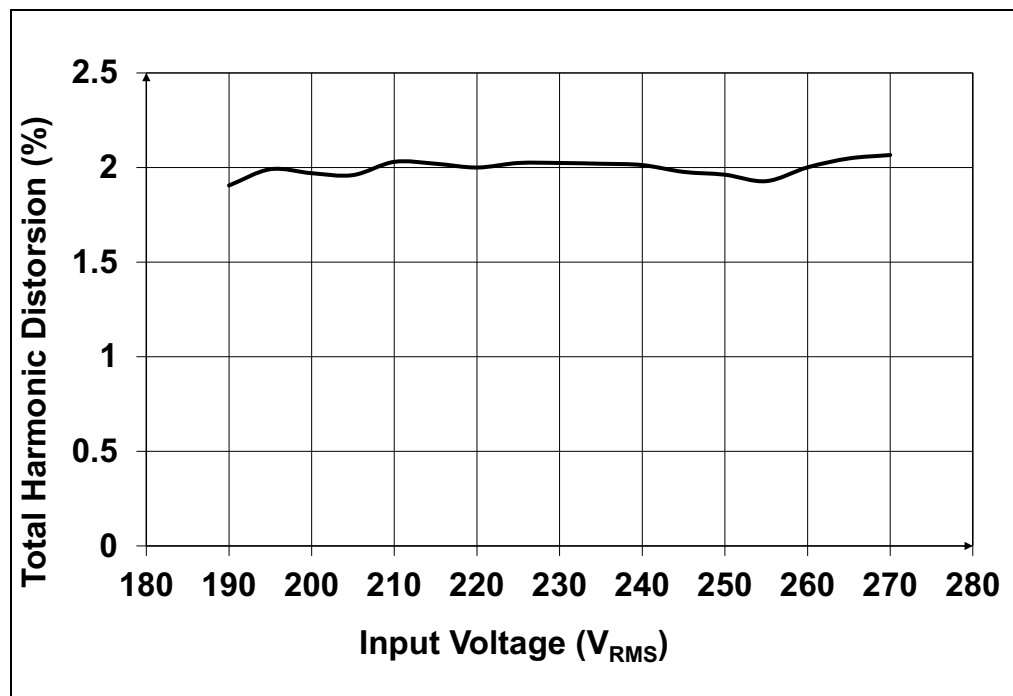

FIGURE 2-14: Total Harmonic Distortion (THD) and Input Voltage.

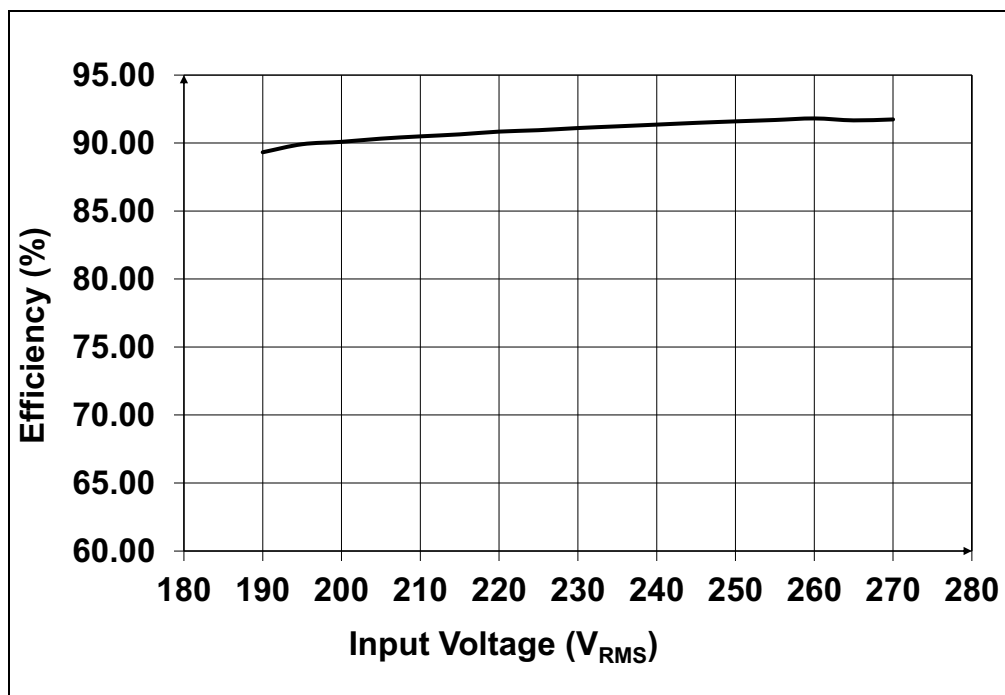

FIGURE 2-15: Efficiency and Input Voltage.

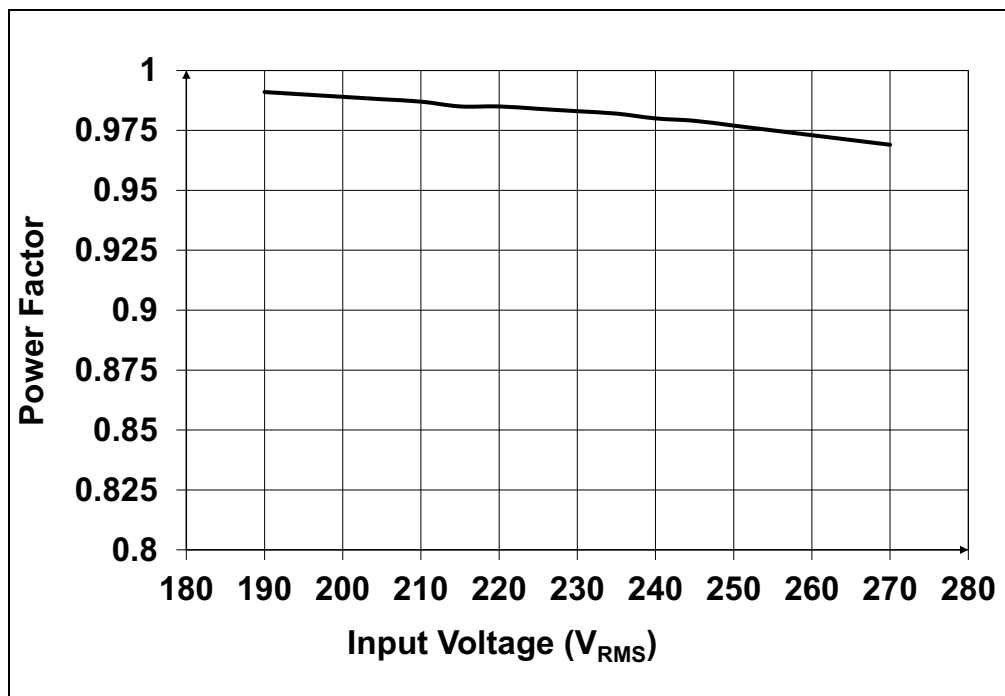

FIGURE 2-16: Power Factor (PF) and Input Voltage.

NOTES:



HV9805 230V_{AC} OFF-LINE LED DRIVER EVALUATION BOARD USER'S GUIDE

Appendix A. Schematic and Layouts

A.1 INTRODUCTION

This appendix contains the following schematics and layouts for the HV9805 230V_{AC} Off-Line LED Driver Evaluation Board.

- Board – Schematic
- Board – Top Silk
- Board – Top Copper
- Board – Bottom Copper

A.2 BOARD - SCHEMATIC

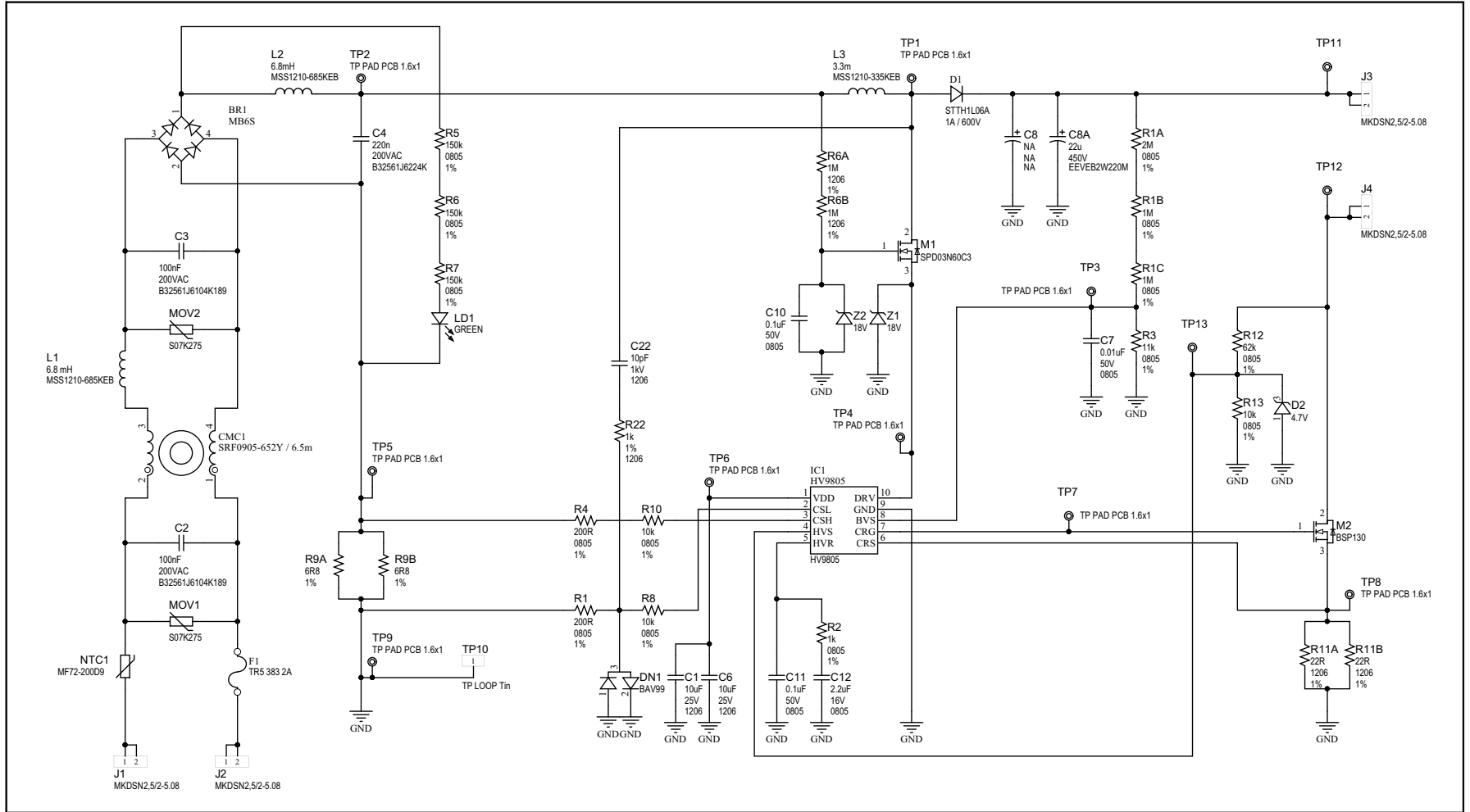

A.3 BOARD – TOP SILK

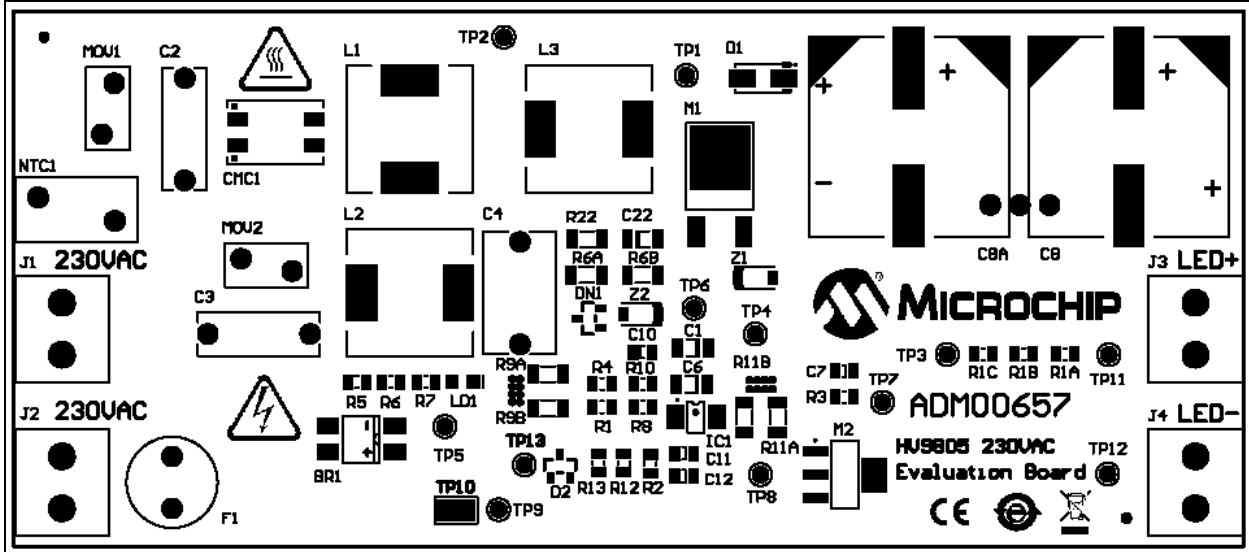

A.4 BOARD – TOP COPPER

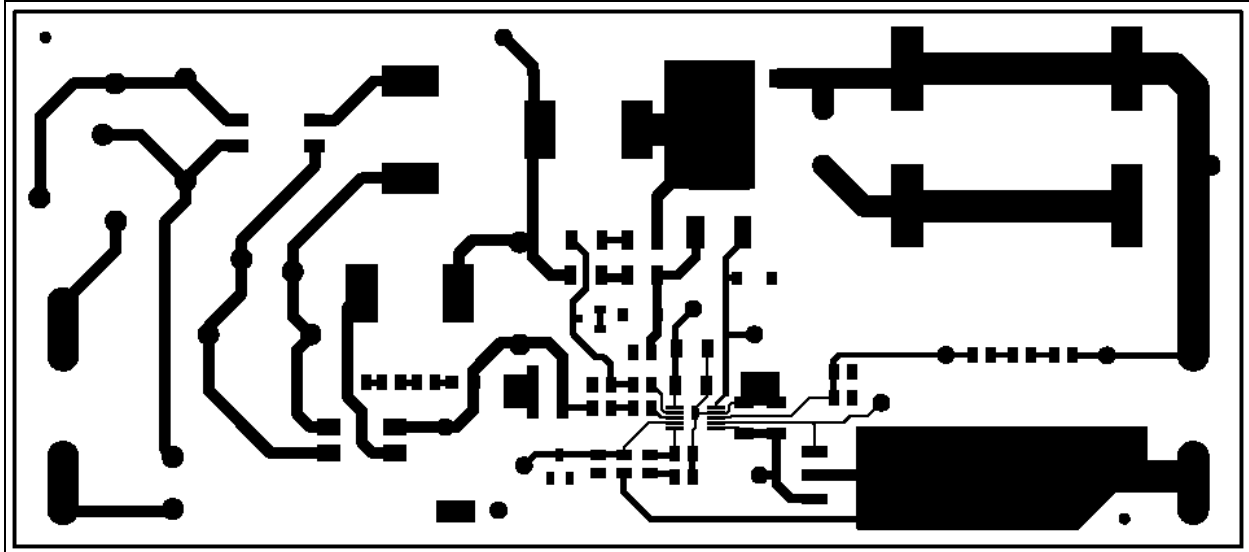

A.5 BOARD – BOTTOM COPPER

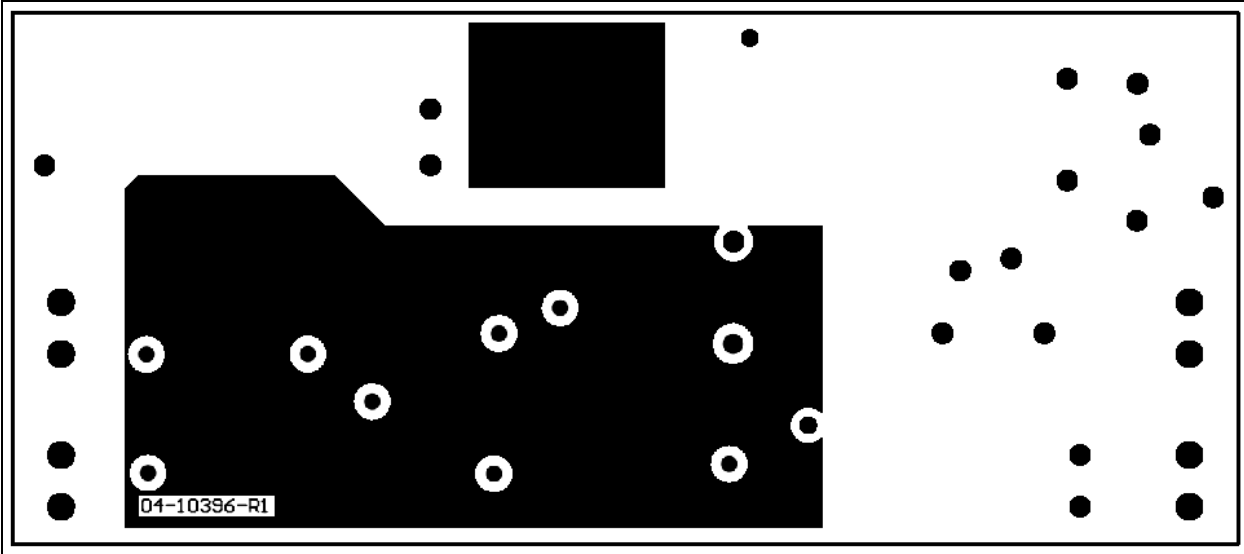

Appendix B. Bill of Materials (BOM)

TABLE B-1: BILL OF MATERIALS (BOM)

Qty.	Reference	Description	Manufacturer	Part Number
1	BR1	IC rect. bridge 0.5A 600V 4SOIC	Fairchild Semiconductor®	MB6S
2	C1, C6	Cap. ceramic 10 µF 25V 10% X7R SMD 1206	Samsung Electro-Mechanics America, Inc.	CL31B106KAHNFNE
2	C2, C3	Film Capacitors 0.1 µF 400V 10%	EPCOS AG	B32561J6104K
1	C4	Film Capacitors 0.22 µF 400V 10%	EPCOS AG	B32561J6224K
1	C7	Cap. ceramic 10 µF 50V 10% X7R SMD 0805	Kemet®	C0805C103K5RACTU
1	C8A	Cap. aluminum 22 µF 450V 20% SMD	Panasonic® – ECG	EEVEB2W220M
2	C10, C11	Cap. ceramic 0.1 µF 50V 10% X7R SMD 0805	Yageo Corporation	CC0805KRX7R9BB104
1	C12	Cap. ceramic 2.2 µF 16V 10% X7R SMD 0805	TDK Corporation	C2012X7R1C225K125AB
1	C22	Cap. ceramic 10 pF 1 kV 10% C0G SMD 1206	Kemet	C1206C100KDGACTU
1	CMC1	Inductor Common Mode 6500 UH 0.3A	Bourns®, Inc.	SRF0905-652Y
1	D1	Diode UltraFast 1A 600V 80 ns SMA	STMicroelectronics	STTH1L06A
1	D2	Diode Zener 4.7V 350 MW SOT23-3	Fairchild Semiconductor	BZX84C4V7
1	DN1	Diode Array GP 70V 200 MA SOT23-3	Fairchild Semiconductor	BAV99
1	F1	Fuse Board Mount 2A 300V _{AC} RAD	Littelfuse®	38312000000
1	IC1	High Voltage LED Driver	Microchip Technology Inc.	HV9805MG-G
4	J1, J2, J3, J4	Conn. Terminal 5.08 mm 16A	PHOENIX CONTACT	MKDSN2,5/2-5.08
2	L1, L2	Power Inductor 6800 µH 10% 0.39 A	Coilcraft	MSS1210-685KEB
1	L3	Power Inductor 3300 µH 10% 0.54 A	Coilcraft	MSS1210-335KEB
1	LD1	Diode LED Green 2V 30 mA 120 mcd Diffuse SMD 0805	Avago Technologies	HSMM-C170
1	M1	MOSFET N-CH 650V 3.2A DPAK	Infineon Technologies AG	SPD03N60C3

Note 1: The components listed in this Bill of Materials are representative of the PCB assembly. The released BOM used in manufacturing uses all RoHS-compliant components.

HV9805 230V_{AC} Off-Line LED Driver Evaluation Board User's Guide

TABLE B-1: BILL OF MATERIALS (BOM) (CONTINUED)

Qty.	Reference	Description	Manufacturer	Part Number
1	M2	MOSFET N-CH 300V 350 MA SC73	NXP Semiconductors	BSP130
2	MOV1, MOV2	Varistor 387V 1.2 KA DISC 7 MM	EPCOS AG	S07K275
1	NTC1	Current Limiter Inrsh 200Ω 20%	Cantherm	MF72-200D9
1	PCB	HV9805 230V _{AC} Off-Line LED Driver Evaluation Board – Printed Circuit Board	Microchip Technology Inc.	04-10396
2	R1, R4	Res. 200R 1% 1/8W SMD 0805	Yageo Corporation	RC0805FR-07200RL
1	R2	Res. 1k 1% 1/10W SMD 0805	Yageo Corporation	RC0805FR-071KL
1	R3	Res. 11k 1% 1/16W SMD 0805	Yageo Corporation	RC0805FR-0711KL
3	R5, R6, R7	Res. 150k 1% 1/8W SMD 0805	Panasonic – ECG	RC0805FR-07150KL
1	R12	Res. 62k 1% 1/8W SMD 0805	Yageo Corporation	RC0805FR-0762KL
4	R13, R8, R10	Res. 10k 1% 1/16W SMD 0805	Yageo Corporation	RC0805FR-0710KL
1	R22	Res. 1k 1% 1/4W SMD 1206	Yageo Corporation	RC1206FR-071KL
1	R1A	Res. 2M 1% 1/8W SMD 0805	Yageo Corporation	RC0805FR-072ML
2	R1B, R1C	Res. 1M 1% 1/8W SMD 0805	Yageo Corporation	RC0805FR-071ML
2	R6A, R6B	Res. 1M 1% 1/4W SMD 1206	Yageo Corporation	RC1206FR-071ML
2	R9A, R9B	Res. 6R8 1% 1/4W SMD 1206	Yageo Corporation	RC1206FR-076R8L
2	R11A, R11B	Res. 22R 1% 1/2W SMD 1206	Yageo Corporation	RC1206FR-0722RL
1	TP10	Conn. TP Loop Tin SMD	Harwin Plc.	S1751-46R
2	Z1, Z2	Diode Zener 18V 500 MW SOD123	Fairchild Semiconductor	MMSZ5248B

Note 1: The components listed in this Bill of Materials are representative of the PCB assembly. The released BOM used in manufacturing uses all RoHS-compliant components.

Bill of Materials (BOM)

NOTES:



MICROCHIP

Worldwide Sales and Service

AMERICAS

Corporate Office
2355 West Chandler Blvd.
Chandler, AZ 85224-6199
Tel: 480-792-7200
Fax: 480-792-7277
Technical Support:
<http://www.microchip.com/support>
Web Address:
www.microchip.com

Atlanta
Duluth, GA
Tel: 678-957-9614
Fax: 678-957-1455

Austin, TX
Tel: 512-257-3370

Boston
Westborough, MA
Tel: 774-760-0087
Fax: 774-760-0088

Chicago
Itasca, IL
Tel: 630-285-0071
Fax: 630-285-0075

Cleveland
Independence, OH
Tel: 216-447-0464
Fax: 216-447-0643

Dallas
Addison, TX
Tel: 972-818-7423
Fax: 972-818-2924

Detroit
Novi, MI
Tel: 248-848-4000

Houston, TX
Tel: 281-894-5983

Indianapolis
Noblesville, IN
Tel: 317-773-8323
Fax: 317-773-5453

Los Angeles
Mission Viejo, CA
Tel: 949-462-9523
Fax: 949-462-9608

New York, NY
Tel: 631-435-6000

San Jose, CA
Tel: 408-735-9110

Canada - Toronto
Tel: 905-673-0699
Fax: 905-673-6509

ASIA/PACIFIC

Asia Pacific Office
Suites 3707-14, 37th Floor
Tower 6, The Gateway
Harbour City, Kowloon
Hong Kong
Tel: 852-2943-5100
Fax: 852-2401-3431

Australia - Sydney
Tel: 61-2-9868-6733
Fax: 61-2-9868-6755

China - Beijing
Tel: 86-10-8569-7000
Fax: 86-10-8528-2104

China - Chengdu
Tel: 86-28-8665-5511
Fax: 86-28-8665-7889

China - Chongqing
Tel: 86-23-8980-9588
Fax: 86-23-8980-9500

China - Dongguan
Tel: 86-769-8702-9880

China - Hangzhou
Tel: 86-571-8792-8115
Fax: 86-571-8792-8116

China - Hong Kong SAR
Tel: 852-2943-5100
Fax: 852-2401-3431

China - Nanjing
Tel: 86-25-8473-2460
Fax: 86-25-8473-2470

China - Qingdao
Tel: 86-532-8502-7355
Fax: 86-532-8502-7205

China - Shanghai
Tel: 86-21-5407-5533
Fax: 86-21-5407-5066

China - Shenyang
Tel: 86-24-2334-2829
Fax: 86-24-2334-2393

China - Shenzhen
Tel: 86-755-8864-2200
Fax: 86-755-8203-1760

China - Wuhan
Tel: 86-27-5980-5300
Fax: 86-27-5980-5118

China - Xian
Tel: 86-29-8833-7252
Fax: 86-29-8833-7256

ASIA/PACIFIC

China - Xiamen
Tel: 86-592-2388138
Fax: 86-592-2388130

China - Zhuhai
Tel: 86-756-3210040
Fax: 86-756-3210049

India - Bangalore
Tel: 91-80-3090-4444
Fax: 91-80-3090-4123

India - New Delhi
Tel: 91-11-4160-8631
Fax: 91-11-4160-8632

India - Pune
Tel: 91-20-3019-1500

Japan - Osaka
Tel: 81-6-6152-7160
Fax: 81-6-6152-9310

Japan - Tokyo
Tel: 81-3-6880-3770
Fax: 81-3-6880-3771

Korea - Daegu
Tel: 82-53-744-4301
Fax: 82-53-744-4302

Korea - Seoul
Tel: 82-2-554-7200
Fax: 82-2-558-5932 or
82-2-558-5934

Malaysia - Kuala Lumpur
Tel: 60-3-6201-9857
Fax: 60-3-6201-9859

Malaysia - Penang
Tel: 60-4-227-8870
Fax: 60-4-227-4068

Philippines - Manila
Tel: 63-2-634-9065
Fax: 63-2-634-9069

Singapore
Tel: 65-6334-8870
Fax: 65-6334-8850

Taiwan - Hsin Chu
Tel: 886-3-5778-366
Fax: 886-3-5770-955

Taiwan - Kaohsiung
Tel: 886-7-213-7828

Taiwan - Taipei
Tel: 886-2-2508-8600
Fax: 886-2-2508-0102

Thailand - Bangkok
Tel: 66-2-694-1351
Fax: 66-2-694-1350

EUROPE

Austria - Wels
Tel: 43-7242-2244-39
Fax: 43-7242-2244-393

Denmark - Copenhagen
Tel: 45-4450-2828
Fax: 45-4485-2829

France - Paris
Tel: 33-1-69-53-63-20
Fax: 33-1-69-30-90-79

Germany - Dusseldorf
Tel: 49-2129-3766400

Germany - Munich
Tel: 49-89-627-144-0
Fax: 49-89-627-144-44

Germany - Pforzheim
Tel: 49-7231-424750

Italy - Milan
Tel: 39-0331-742611
Fax: 39-0331-466781

Italy - Venice
Tel: 39-049-7625286

Netherlands - Drunen
Tel: 31-416-690399
Fax: 31-416-690340

Poland - Warsaw
Tel: 48-22-3325737

Spain - Madrid
Tel: 34-91-708-08-90
Fax: 34-91-708-08-91

Sweden - Stockholm
Tel: 46-8-5090-4654

UK - Wokingham
Tel: 44-118-921-5800
Fax: 44-118-921-5820

01/27/15