



## SY89112U

### 2.5/3.3V Low-Jitter, Low-Skew 1:12 LVPECL Fanout Buffer with 2:1 Input MUX and Internal Termination

#### General Description

The SY89112U is a low-jitter, low-skew, high-speed LVPECL 1:12 differential fanout buffer optimized for precision telecom and enterprise server distribution applications. The input includes a 2:1 MUX for clock switchover application. Unlike other multiplexers, this input includes a unique isolation design to minimize channel-to-channel crosstalk. The SY89112U distributes clock frequencies from DC to >2GHz guaranteed over temperature and voltage. The SY89112U incorporates a synchronous output enable (EN) so that the outputs will only be enabled/disabled when they are already in the LOW state. This reduces the chance of generating "runt" clock pulses.

The SY89112U differential input includes Micrel's unique, patent-pending 3-pin input termination architecture that directly interfaces to any differential signal (AC- or DC-coupled) as small as 100mV (200mV<sub>pp</sub>) without any level shifting or termination resistor networks in the signal path. For AC-coupled input interface, an on-board output reference voltage (VREF-AC) is provided to bias the center-tap (VT) pin. The outputs are 800mV, 100K-compatible LVPECL with fast rise/fall times guaranteed to be less than 220ps.

The SY89112U operates from a 2.5V  $\pm$ 5% or 3.3V  $\pm$ 10% supply and is guaranteed over the full industrial temperature range of  $-40^{\circ}\text{C}$  to  $+85^{\circ}\text{C}$ . The SY89112U is part of Micrel's high-speed, Precision Edge<sup>®</sup> product line.

Datasheets and support documentation are available on Micrel's web site at: [www.micrel.com](http://www.micrel.com).

#### Features

- Selects between 1 of 2 inputs, and provides 12 precision, low skew LVPECL output copies
- Guaranteed AC performance over temperature and voltage:
  - DC to >2GHz throughput
  - <550ps propagation delay CLK-to-Q
  - <220ps rise/fall time
  - <25ps output-to-output skew
- Ultra-low jitter design:
  - 50fs<sub>RMS</sub> phase jitter (typ.)
  - <0.7ps<sub>RMS</sub> crosstalk induced jitter
- Unique, patent-pending input termination and VT pin accepts DC-coupled and AC-coupled differential inputs
- Unique, patent-pending 2:1 input MUX provides superior isolation to minimize channel-to-channel crosstalk
- 800mV, 100K LVPECL output swing
- Power supply 2.5V  $\pm$ 5% or 3.3V  $\pm$ 10%
- Industrial temperature range  $-40^{\circ}\text{C}$  to  $+85^{\circ}\text{C}$
- Available in 44-pin (7mm x 7mm) QFN package

#### Applications

- Multi-processor server
- SONET/SDH clock/data distribution
- Fibre Channel distribution
- Gigabit Ethernet clock distribution

### Functional Block Diagram

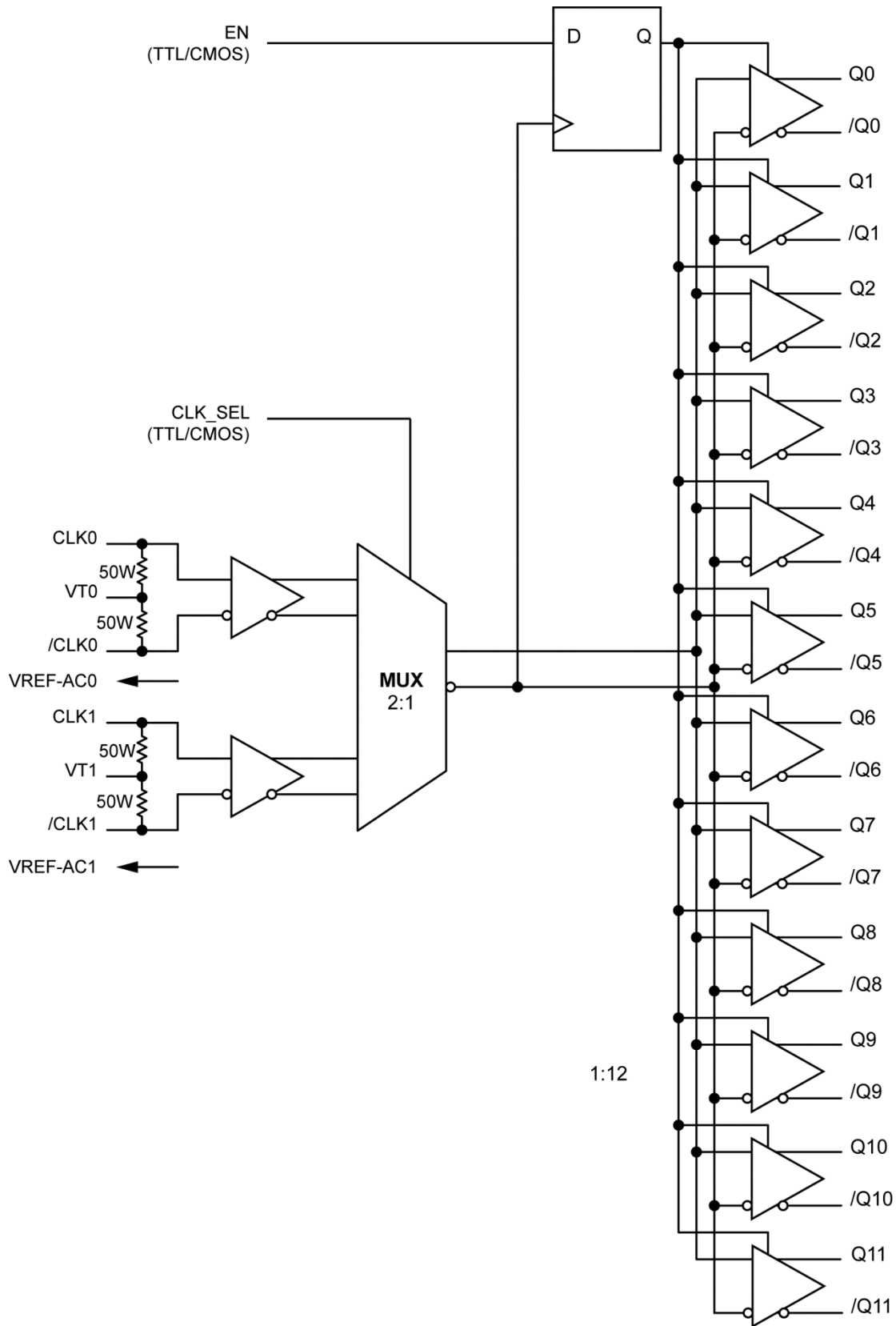

## Ordering Information

Part Number <sup>(1)</sup>	Package Type	Operating Range	Package Marking	Lead Finish
SY89112UMI	QFN-44	Industrial	SY89112U	Sn-Pb
SY89112UMITR <sup>(2)</sup>	QFN-44	Industrial	SY89112U	Sn-Pb
SY89112UMY	QFN-44	Industrial	SY89112U with Pb-Free bar-line indicator	Matte-Sn Pb-Free
SY89112UMYTR <sup>(2)</sup>	QFN-44	Industrial	SY89112U with Pb-Free bar-line indicator	Matte-Sn Pb-Free

**Notes:**

1. Contact factory for die availability. Dice are guaranteed at T<sub>A</sub> = 25°C, DC Electricals only.
2. Tape and Reel.

## Pin Configuration

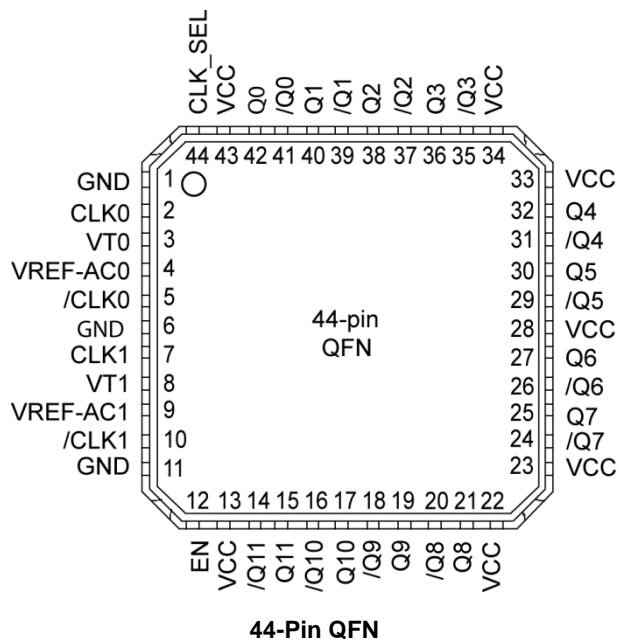

## Pin Description

Pin Number	Pin Name	Pin Function
2, 5 7, 10	CLK0, /CLK0 CLK1, /CLK1	Differential Inputs: These input pairs are the differential signal inputs to the device. Inputs accept AC- or DC-coupled differential signals as small as 100mV. Each pin of a pair internally terminates to a VT pin through 50Ω. Note that these inputs will default to an indeterminate state if left open. Please refer to the “Input Interface Applications” section for more details.
3, 8	VT0, VT1	Input Termination Center-Tap: Each side of the differential input pair terminates to a VT pin. The VT pins provide a center-tap to a termination network for maximum interface flexibility. See “Input Interface Applications” section for more details.
4, 9	VREF-AC0 VREF-AC1	Reference Voltage: These outputs bias to $V_{CC}-1.2V$ . They are used when AC coupling the inputs (CLK, /CLK). For AC-coupled applications, connect $V_{REF-AC}$ to the VT pin and bypass with a 0.01μF low ESR capacitor to $V_{CC}$ . See “Input Interface Applications” section for more details. Maximum sink/source current is ±1.5mA. Due to the limited drive capability, each VREF-AC pin is only intended to drive its respective VT pin.
44	CLK_SEL	This single-ended TTL/CMOS-compatible input selects the inputs to the multiplexer. Note that this input is internally connected to a 25kΩ pull-up resistor and will default to a logic HIGH state if left open.
12	EN	This single-ended TTL/CMOS-compatible input functions as a synchronous output enable. The synchronous enable ensures that enable/disable will only occur when the outputs are in a logic LOW state. Note that this input is internally connected to a 25kΩ pull-up resistor and will default to logic HIGH state (enabled) if left open.
13,22,23,28, 33,34,43	VCC	Positive power supply. Bypass with 0.1μF//0.01μF low ESR capacitors and place as close to each VCC pin as possible.
42, 41 40, 39 38, 37 36, 35 32, 31 30, 29 27, 26 25, 24 21, 20 19, 18 17, 16 15, 14	Q0, /Q0 Q1, /Q1 Q2, /Q2 Q3, /Q3 Q4, /Q4 Q5, /Q5 Q6, /Q6 Q7, /Q7 Q8, /Q8 Q9, /Q9 Q10, /Q10 Q11, /Q11	Differential 100K LVPECL Outputs: These LVPECL outputs are the precision, low skew copies of the inputs. Please refer to the truth table below for details. Unused output pairs may be left open. Terminate with 50Ω to $V_{CC}-2V$ . See “LVPECL Output Interface Applications” section for more details.
1, 6, 11	GND, Exposed Pad	Ground. GND pins and exposed pad must both be connected to the most negative potential of chip the ground.

## Truth Table

EN	CLK_SEL	Q	/Q
H	L	CLK0	/CLK0
H	H	CLK1	/CLK1
L	X	L <sup>(3)</sup>	H <sup>(3)</sup>

### Notes:

3. Transition occurs on next negative transition of the non-inverted input.

**Absolute Maximum Ratings<sup>(4)</sup>**

Supply Voltage ( $V_{CC}$ )	-0.5V to +4.0V
Input Voltage ( $V_{IN}$ )	-0.5V to $V_{CC}$
LVPECL Output Current ( $I_{OUT}$ )	
Continuous	50mA
Surge	100mA
Termination Current	
Source or sink current on VT	$\pm 100$ mA
Input Current	
Source or sink current on CLK, /CLK	$\pm 50$ mA
$V_{REF-AC}$ Current	
Source or sink current	$\pm 2$ mA
Lead Temperature (soldering, 20sec)	+260°C
Storage Temperature (TS)	-65°C to +150°C

**Operating Ratings<sup>(5)</sup>**

Supply Voltage ( $V_{CC}$ )	+2.375V to +2.625V +3.0V to +3.6V
Ambient Temperature ( $T_A$ )	-40°C to +85°C
Package Thermal Resistance <sup>(6)</sup>	
QFN ( $\theta_{JA}$ )	
Still-Air	42°C/W
QFN ( $\psi_{JB}$ )	
Junction-to-Board	20°C/W

**DC Electrical Characteristics<sup>(7)</sup>**

$T_A = -40^\circ\text{C}$  to  $+85^\circ\text{C}$ , unless otherwise stated.

Symbol	Parameter	Condition	Min.	Typ.	Max.	Units
$V_{CC}$	Power Supply		2.375 3.0		2.625 3.6	V V
$I_{CC}$	Power Supply Current	No load, max. $V_{CC}$		95	130	mA
$R_{IN}$	Input Resistance (IN-to-VT)		45	50	55	$\Omega$
$R_{DIFF\_IN}$	Differential Input Resistance (IN-to-/IN)		90	100	110	$\Omega$
$V_{IH}$	Input High Voltage (IN, /IN)		1.2		$V_{CC}$	V
$V_{IL}$	Input Low Voltage (IN, /IN)		0		$V_{IH} - 0.1$	V
$V_{IN}$	Input Voltage Swing (IN, /IN)	See <a href="#">Figure 1</a>	0.1		1.7	V
$V_{DIFF\_IN}$	Differential Input Voltage Swing  IN-/IN	See <a href="#">Figure 2</a>	0.2			V
$V_{T\_IN}$	IN-to-VT (IN, /IN)				1.28	V
$V_{REF-AC}$	Output Reference Voltage		$V_{CC} - 1.3$	$V_{CC} - 1.2$	$V_{CC} - 1.1$	V

**Notes:**

- Permanent device damage may occur if absolute maximum ratings are exceeded. This is a stress rating only and functional operation is not implied at conditions other than those detailed in the operational sections of this data sheet. Exposure to absolute maximum ratings conditions for extended periods may affect device reliability.
- The datasheet limits are not guaranteed if the device is operated beyond the operating ratings
- Package thermal resistance assumes exposed pad is soldered (or equivalent) to the devices most negative potential on the PCB.  $\theta_{JA}$  and  $\psi_{JB}$  values are determined for a 4-layer board in still-air, unless otherwise stated.
- The circuit is designed to meet the DC specifications shown in the above table after thermal equilibrium has been established.

## LVPECL Outputs DC Electrical Characteristics<sup>(7)</sup>

$V_{CC} = +2.5V \pm 5\%$  or  $+3.3V \pm 10\%$ ;  $T_A = -40^\circ C$  to  $+85^\circ C$ ;  $R_L = 50\Omega$  to  $V_{CC} - 2V$ , unless otherwise stated.

Symbol	Parameter	Condition	Min.	Typ.	Max.	Units
$V_{OH}$	Output HIGH Voltage (Q, /Q)		$V_{CC} - 1.145$		$V_{CC} - 0.895$	V
$V_{OL}$	Output LOW Voltage (Q, /Q)		$V_{CC} - 1.945$		$V_{CC} - 1.695$	V
$V_{OUT}$	Output Voltage Swing (Q, /Q)	See Figure 1a	550	800		mV
$V_{DIFF-OUT}$	Differential Output Voltage Swing (Q, /Q)	See Figure 1b	1100	1600		mV

## LVTTTL/CMOS DC Electrical Characteristics<sup>(7)</sup>

$V_{CC} = +2.5V \pm 5\%$  or  $+3.3V \pm 10\%$ ;  $T_A = -40^\circ C$  to  $+85^\circ C$ , unless otherwise stated.

Symbol	Parameter	Condition	Min.	Typ.	Max.	Units
$V_{IH}$	Input HIGH Voltage		2.0		$V_{CC}$	V
$V_{IL}$	Input LOW Voltage				0.8	V
$I_{IH}$	Input HIGH Current		-125		30	$\mu A$
$I_{IL}$	Input LOW Current		-300			$\mu A$

## AC Electrical Characteristics<sup>(8)</sup>

$V_{CC} = +2.5V \pm 5\%$  or  $+3.3V \pm 10\%$ ;  $T_A = -40^\circ C$  to  $+85^\circ C$ ,  $R_L = 50\Omega$  to  $V_{CC} - 2V$ , unless otherwise stated.

Symbol	Parameter	Condition	Min.	Typ.	Max.	Units
$f_{MAX}$	Maximum Operating Frequency	$V_{OUT} \geq 400mV$	2	3		GHz
$t_{PD}$	Propagation Delay CLK to Q	$V_{IN} \geq 100mV$	300	400	550	ps
	Propagation Delay CLK_SEL to Q		200	350	600	ps
$t_{PD}$ Tempco	Differential Propagation Delay Temperature Coefficient			150		fs/ $^\circ C$
$t_S$	Set-up Time EN-to-CLK	<b>Note 9</b>	0			ps
$t_H$	Hold Time CLK-to-EN	<b>Note 9</b>	500			ps
$t_{SKEW}$	Output-to-Output Skew	<b>Note 10</b>			25	ps
	Part-to-Part Skew	<b>Note 11</b>			200	
$t_{JITTER}$	RMS Phase Jitter	Output = 622MHz, Integration Range: 12kHz – 20MHz		50		f <sub>SRMS</sub>
	Adjacent Channel Crosstalk-induced Jitter	<b>Note 12</b>			0.7	ps <sub>(rms)</sub>
$t_r, t_f$	Output Rise/Fall Time (20% to 80%)	At full output swing.	70	140	220	ps

### Notes:

8. High-frequency AC-parameters are guaranteed by design and characterization.
9. Set-up and hold times apply to synchronous applications that intend to enable/disable before the next clock cycle. For asynchronous applications, set-up and hold do not apply.
10. Output-to-output skew is measured between two different outputs under identical input transitions.
11. Part-to-part skew is defined for two parts with identical power supply voltages at the same temperature and with no skew of the edges at the respective inputs.
12. Crosstalk is measured at the output while applying two similar differential clock frequencies that are asynchronous with respect to each other at the inputs.

### Additive Phase Noise Plot

$V_{CC} = +3.3V$ ,  $GND = 0$ ,  $R_L = 50\Omega$  to  $V_{CC}-2V$ ,  $T_A = 25^\circ C$

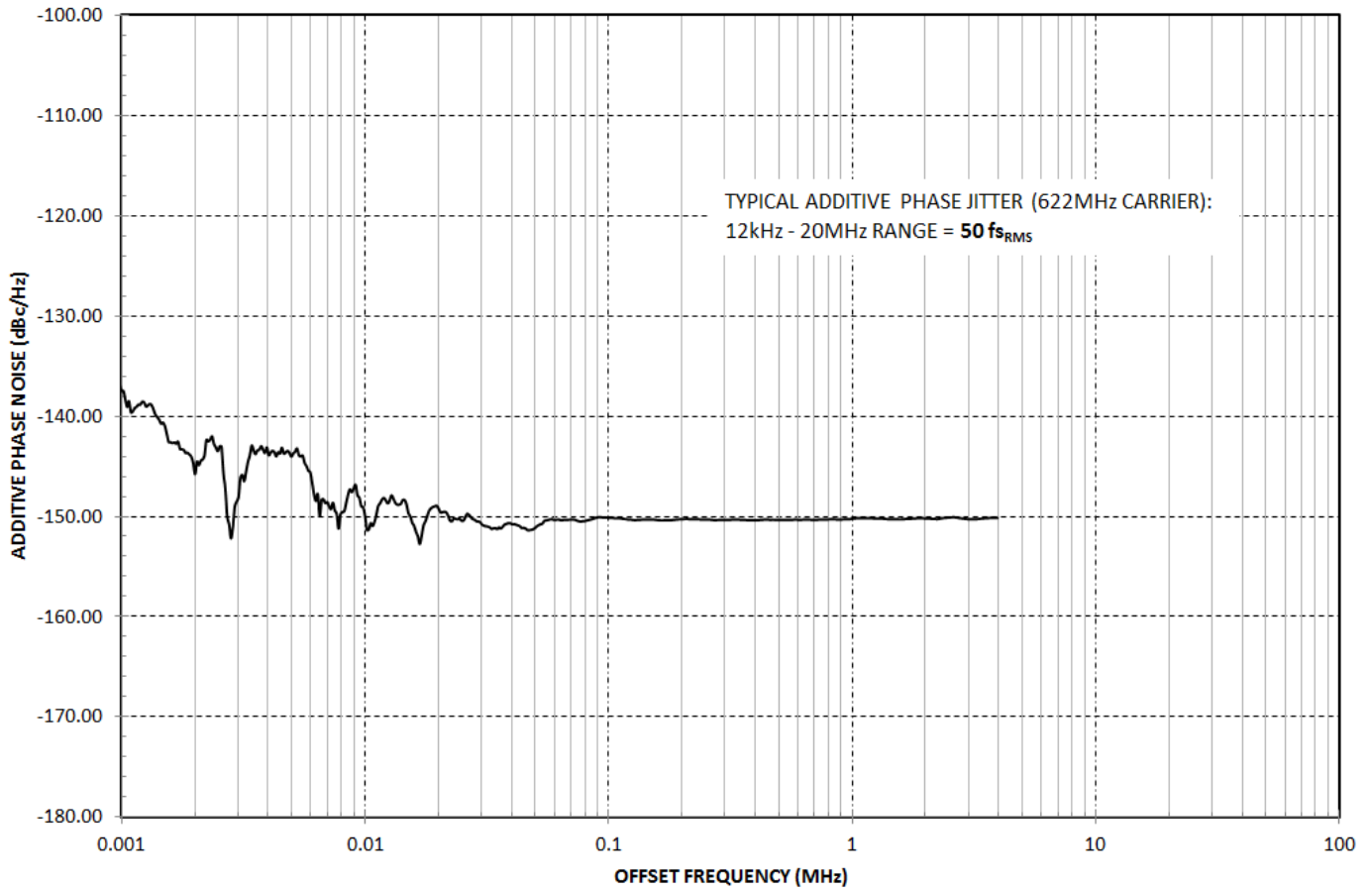



### Typical Characteristics

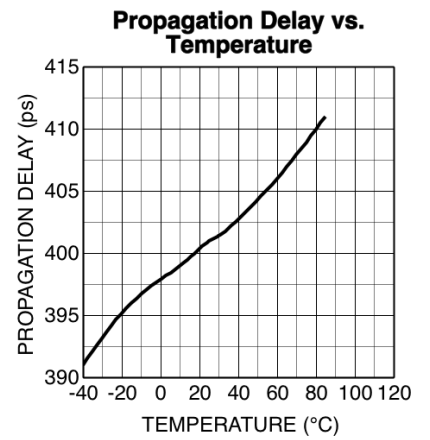
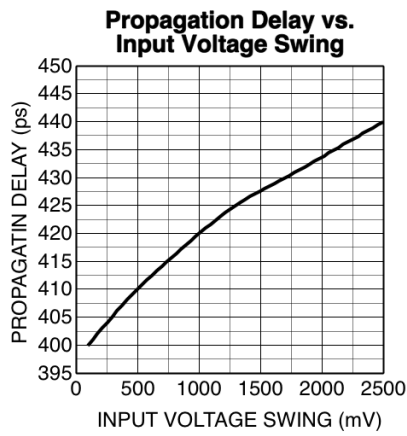
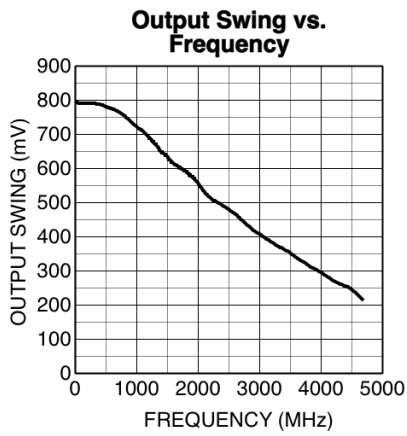

## Functional Characteristics

$V_{CC} = +3.3V$ ,  $GND = 0$ ,  $V_{IN} = 100mV$ ,  $R_L = 50\Omega$  to  $V_{CC} - 2V$ ,  $T_A = 25^\circ C$ , unless otherwise stated.

**200MHz Output**

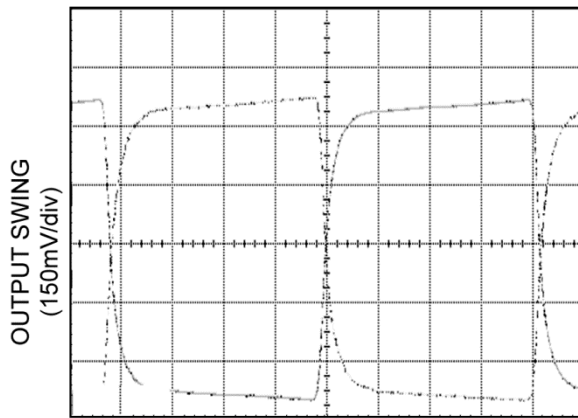

TIME (600ps/div)

**1GHz Output**

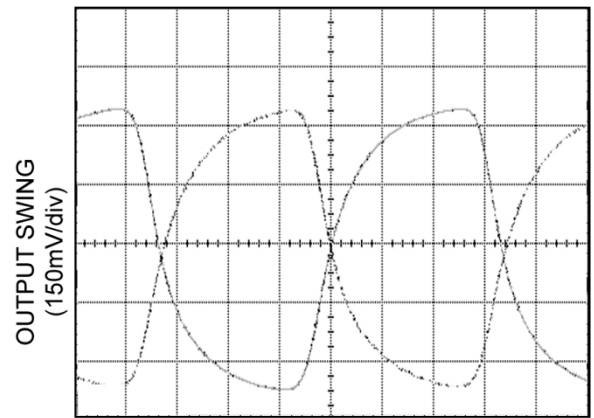

TIME (150ps/div)

**2GHz Output**

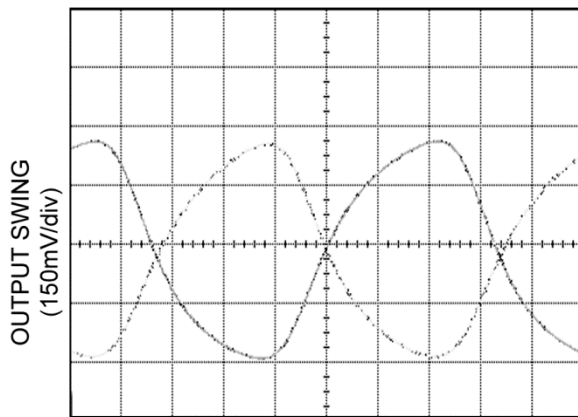

TIME (75ps/div)

**622Mbps Output**

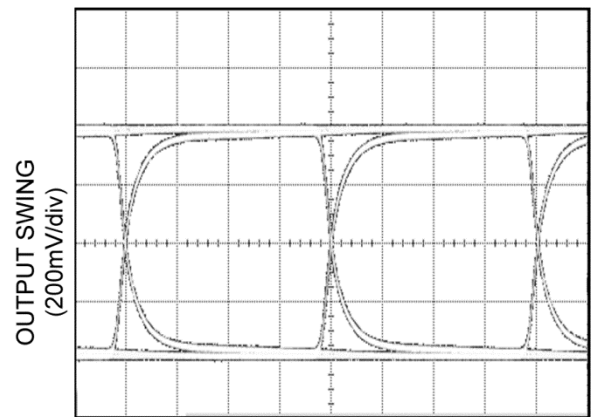

TIME (400ps/div)

**1.25Gbps Output**

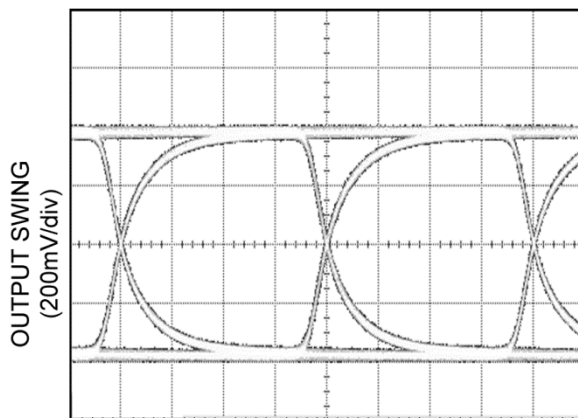

TIME (200ps/div)

**2.5Gbps Output**

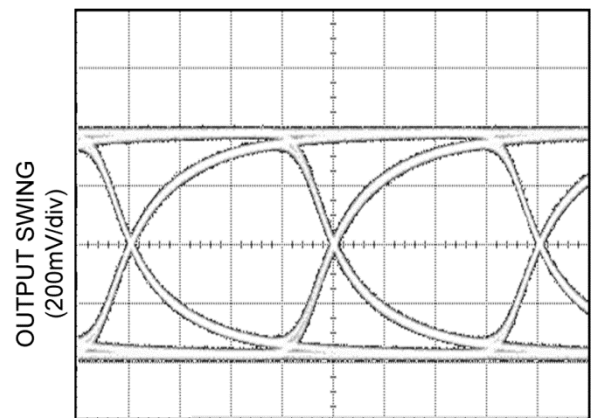

TIME (100ps/div)

## Single-Ended and Differential Swings

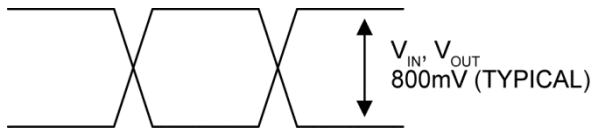

Figure 1. Single-Ended Voltage Swing

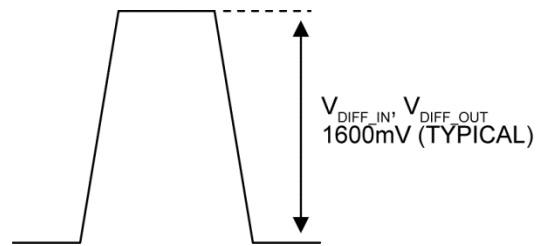

Figure 2. Differential Voltage Swing

## Timing Diagrams

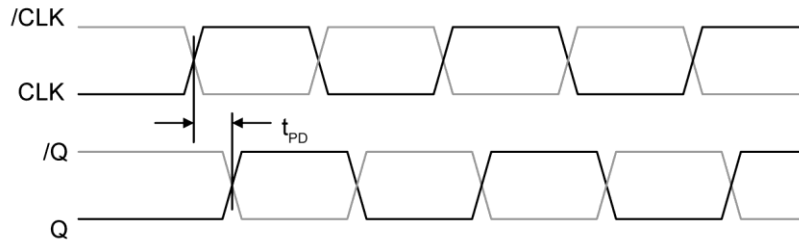

Figure 3.  $t_{PD}$  – Differential In-to-Differential Out

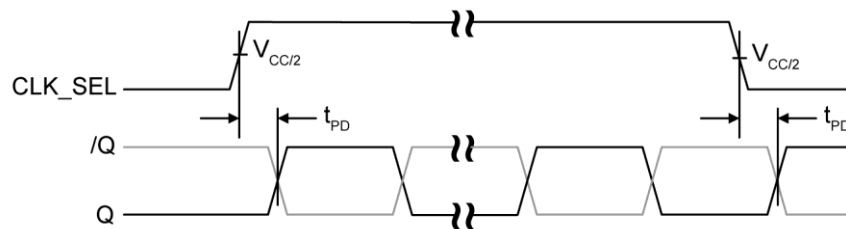

Figure 4.  $t_{PD}$  – CLK\_SEL-to-Differential Out

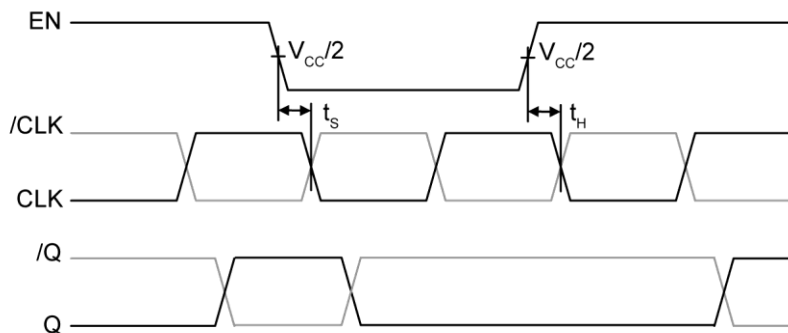

Figure 5.  $t_{PD}$  – Set-Up and Hold Time EN-to-Differential Out



### LVPECL Output Interface Applications

LVPECL has high-input impedance, very-low output (open emitter) impedance, and small signal swing, which result in low EMI. LVPECL is ideal for driving 50Ω and 100Ω controlled impedance transmission lines. There are several techniques for terminating the LVPECL output:

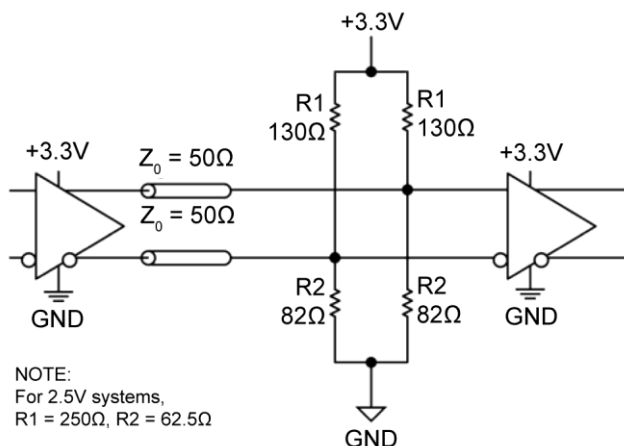

Figure 13. Parallel Thevenin-Equivalent Termination

Parallel Termination-Thevenin Equivalent, Parallel Termination (3-Resistor), and AC-Coupled Termination. Unused output pairs may be left floating. However, single-ended outputs must be terminated or balanced.

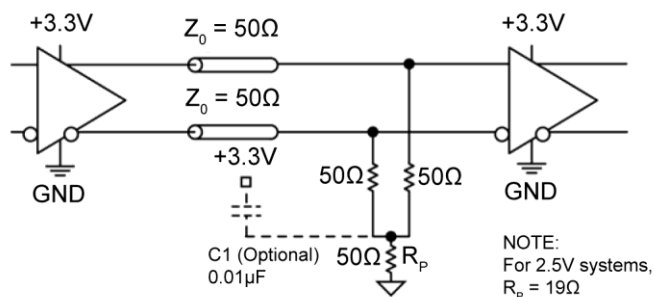
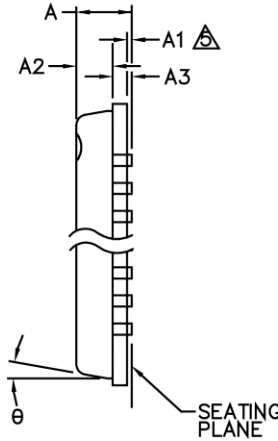
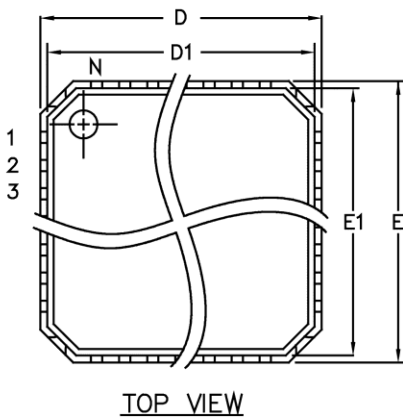

Figure 14. Parallel Termination (3-Resistor)

### Related Product and Support Documentation

Part Number	Function	Datasheet Link
SY89113U	2.5V/3.3V Low-Jitter, Low-Skew, 1:12 LVDS Fanout Buffer with 2:1 Input MUX and Internal Termination	<a href="http://www.micrel.com/PDF/HBW/sy89113u.pdf">http://www.micrel.com/PDF/HBW/sy89113u.pdf</a>
HBW Solutions	New Products and Applications	<a href="http://www.micrel.com/index.php/en/products/clock-timing.html">http://www.micrel.com/index.php/en/products/clock-timing.html</a>

Package Information<sup>(13)</sup>



	DIMENSION (mm)		
	MIN.	NOM.	MAX.
A	—	0.85	0.90
A1	0.00	0.01	0.05
A2	—	0.65	0.70
A3	0.20 REF.		
D	7.00 BSC		
D1	6.75 BSC		
D2	3.15	3.30	3.45
E	7.00 BSC		
E1	6.75 BSC		
E2	3.15	3.30	3.45
θ			12°
P	0.24	0.42	0.60
e	0.50 BSC		
N	44		
L	0.50	0.60	0.75
b	0.18	0.23	0.30

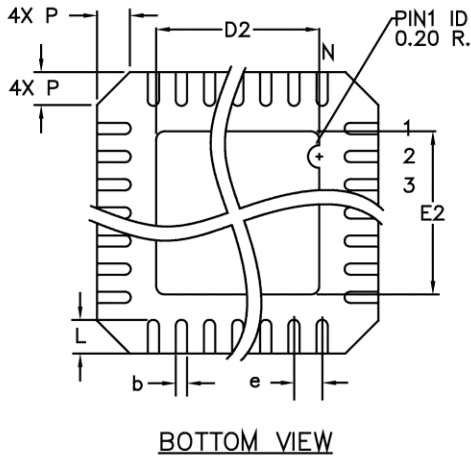

- NOTE:
- ALL DIMENSIONS ARE IN MILLIMETERS.
  - N IS THE NUMBER OF TERMINALS. THE NUMBER OF TERMINALS PER SIDE IS N/4.
  - THE PIN#1 IDENTIFIER MUST BE EXISTED ON THE TOP SURFACE OF PACKAGE BY USING IDENTIFICATION MARK OR OTHER FEATURE OF PACKAGE BODY.
  - PACKAGE WARPAGE MAX 0.05mm.
- △ APPLIED FOR EXPOSED PAD AND TERMINALS.

44-Pin QFN

Note:

13. Package information is correct as of the publication date. For updates and most current information, go to [www.micrel.com](http://www.micrel.com).

MICREL, INC. 2180 FORTUNE DRIVE SAN JOSE, CA 95131 USA  
 TEL +1 (408) 944-0800 FAX +1 (408) 474-1000 WEB <http://www.micrel.com>

Micrel makes no representations or warranties with respect to the accuracy or completeness of the information furnished in this data sheet. This information is not intended as a warranty and Micrel does not assume responsibility for its use. Micrel reserves the right to change circuitry, specifications and descriptions at any time without notice. No license, whether express, implied, arising by estoppel or otherwise, to any intellectual property rights is granted by this document. Except as provided in Micrel's terms and conditions of sale for such products, Micrel assumes no liability whatsoever, and Micrel disclaims any express or implied warranty relating to the sale and/or use of Micrel products including liability or warranties relating to fitness for a particular purpose, merchantability, or infringement of any patent, copyright or other intellectual property right.

Micrel Products are not designed or authorized for use as components in life support appliances, devices or systems where malfunction of a product can reasonably be expected to result in personal injury. Life support devices or systems are devices or systems that (a) are intended for surgical implant into the body or (b) support or sustain life, and whose failure to perform can be reasonably expected to result in a significant injury to the user. A Purchaser's use or sale of Micrel Products for use in life support appliances, devices or systems is a Purchaser's own risk and Purchaser agrees to fully indemnify Micrel for any damages resulting from such use or sale.