

LC QUAD ADAPTER P/N	LC QUAD ADAPTER COLOR	SPLIT SLEEVE MATERIAL
106123-0200	BLUE	ZR
106123-0205*		
106123-1200	BEIGE	PHOSPHOR BRONZE
106123-1205*		
106123-2200	GREEN	ZR
106123-3200	AQUA	PHOSPHOR BRONZE
106123-3205*		

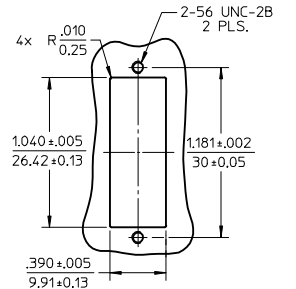

**RECOMMENDED  
MOUNTING PATTERN  
SCALE 1.5:1**

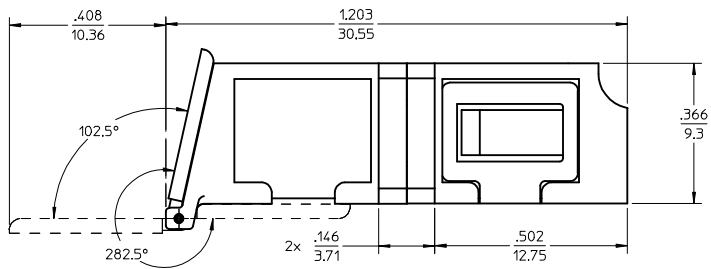
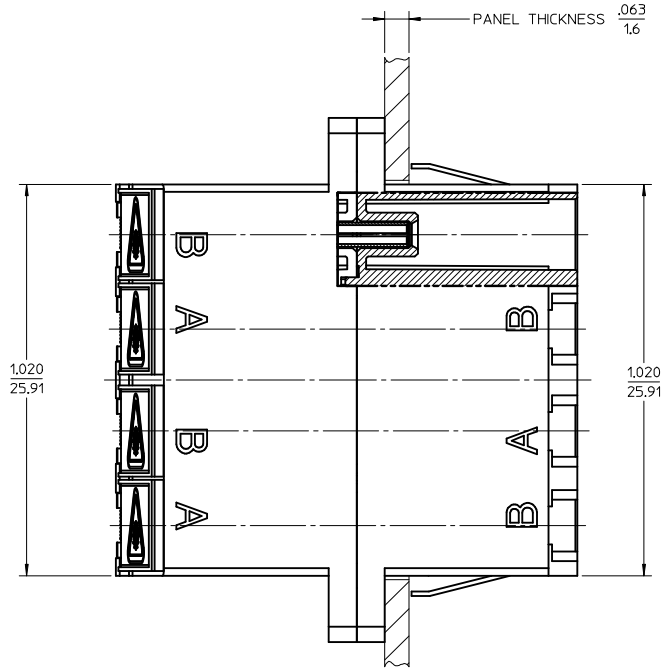
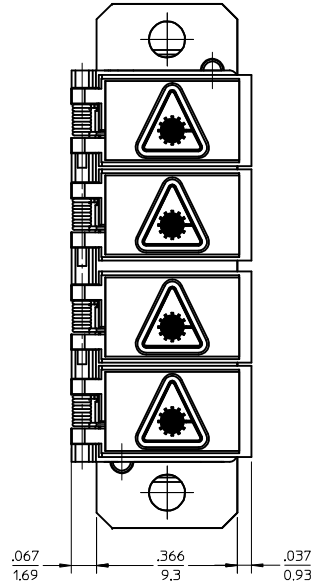
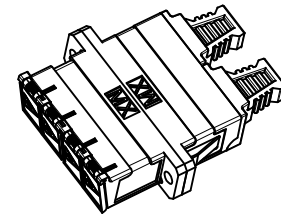
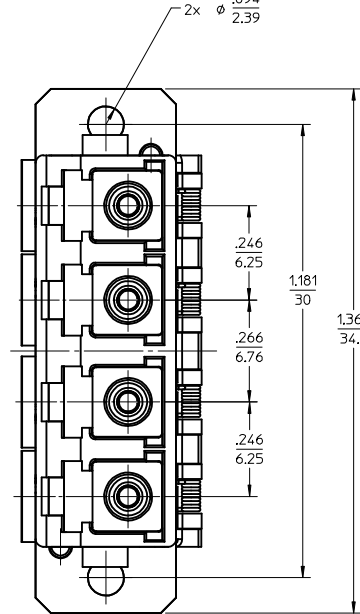

**ISO VIEW 2  
SCALE 1.5:1**

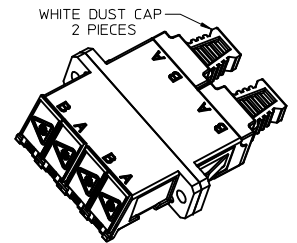

**ISO VIEW 1  
SCALE 1.5:1**

**NOTES:**

- ALL DIMENSIONS ARE FOR REFERENCE.
- DUST CAPS NOT SHOWN ON FRONT, BOTTOM AND RIGHT VIEW.
- LC QUAD ADAPTER HAS SC DUPLEX ADAPTER FOOTPRINT.
- \*4. P/Ns MARKED WITH(\*) ARE BULK PACKED IN QUANTITIES OF 100 pcs.

<b>ENTER DESCRIPTION</b> IEC NO: MF-2013-0549 DRW:KPEVZNER 2013/03/04 CHKD: APPR:IGUMIN 2013/03/07 REV:	QUALITY SYMBOLS ▽=0 ▽=0	GENERAL TOLERANCES (UNLESS SPECIFIED) <table border="1"> <thead> <tr> <th></th> <th>mm</th> <th>INCH</th> </tr> </thead> <tbody> <tr> <td>4 PLACES</td> <td>±---</td> <td>±---</td> </tr> <tr> <td>3 PLACES</td> <td>±---</td> <td>±---</td> </tr> <tr> <td>2 PLACES</td> <td>±---</td> <td>±---</td> </tr> <tr> <td>1 PLACE</td> <td>±---</td> <td>±---</td> </tr> </tbody> </table>		mm	INCH	4 PLACES	±---	±---	3 PLACES	±---	±---	2 PLACES	±---	±---	1 PLACE	±---	±---	DIMENSION STYLE <b>IN/MM</b>	SCALE <b>4:1</b>	DESIGN UNITS <b>INCH</b>	THIRD ANGLE PROJECTION
		mm	INCH																		
	4 PLACES	±---	±---																		
	3 PLACES	±---	±---																		
2 PLACES	±---	±---																			
1 PLACE	±---	±---																			
DRAFT WHERE APPLICABLE MUST REMAIN WITHIN DIMENSIONS	MATERIAL NO. <b>SEE TABLE</b>	DATE 2005/11/21	<b>LC QUAD ADAPTER WITH SHUTTERS (SCREW AND SNAP MOUNT)</b>																		
SIZE <b>C</b>	DOCUMENT NO. <b>SD-106123-X200</b>	APPROVED BY DATE	<b>MOLEX INCORPORATED</b>																		
<b>A2</b>	THIS DRAWING CONTAINS INFORMATION THAT IS PROPRIETARY TO MOLEX INCORPORATED AND SHOULD NOT BE USED WITHOUT WRITTEN PERMISSION	SHEET NO. <b>1 OF 1</b>																			