

PADS OF PRODUCT FOR SOLDER

LOGO WITH SERIES NO.

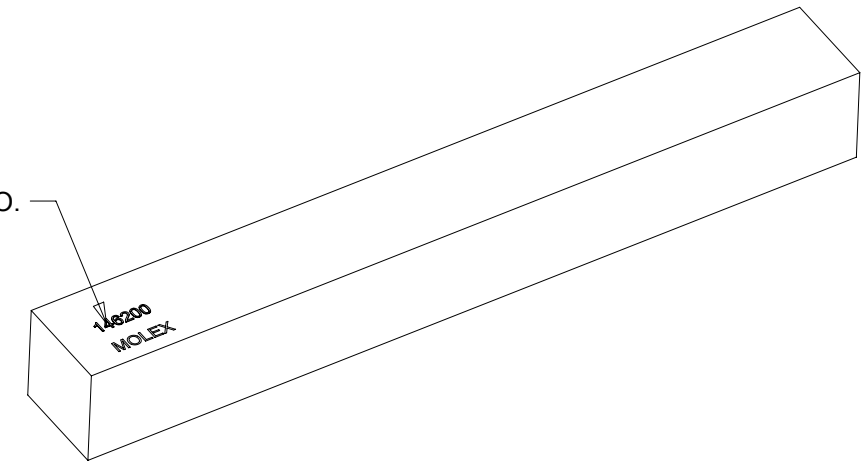

3D VIEW

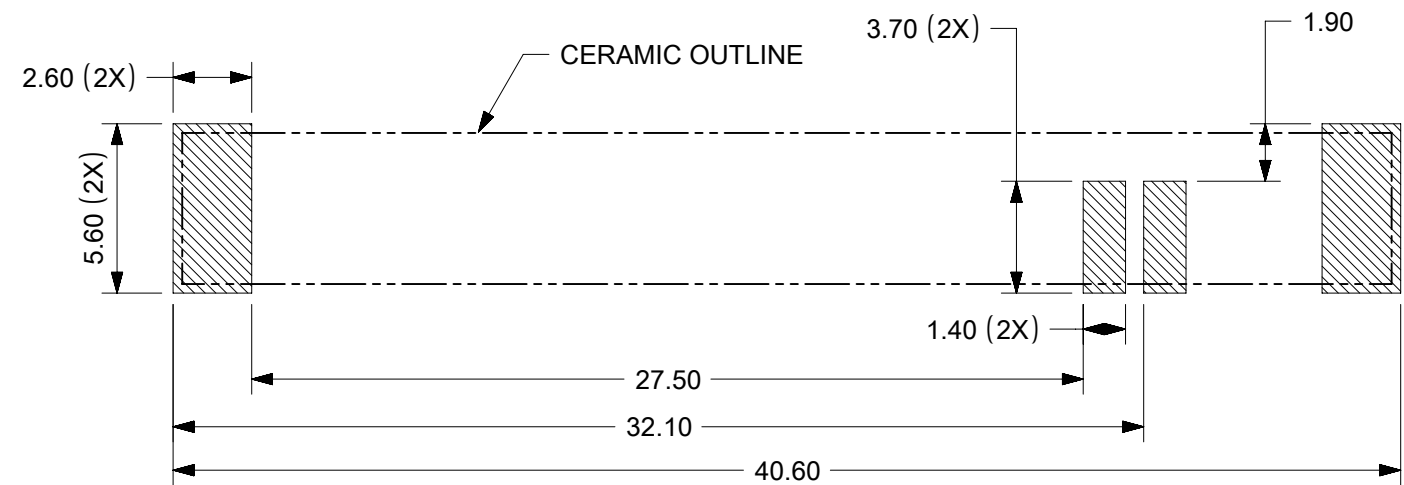

RECOMMENDED PCB LAYOUT

NOTES:

1. MATERIAL: CERAMIC, P/N: 1462000001
2. PATTERN: Ag PLATED, THICKNESS 6-11um
3. PACKAGE SPEC. REFER TO PK OF 1462000001
4. PRODUCT SPEC. REFER TO PS OF 1462000001
5. APPLICATION SPEC. REFER TO AS OF 1462000001
6. SUGGEST TO USE RED GLUE UNDER PART BEFORE SMT IF APPLICATION CONDITION IS STRICT

THIS DRAWING CONTAINS INFORMATION THAT IS PROPRIETARY TO MOLEX ELECTRONIC TECHNOLOGIES, LLC AND SHOULD NOT BE USED WITHOUT WRITTEN PERMISSION									
QUALITY SYMBOLS ▽ = 0 ▽ = 0 ▽ = 0 ▼ = 0 ▽ = 0 ⊠ = 0 ■ = 0 ▽ = 0	EC NO: 170025 DRWN: KCHENG06 CHKD: CXU11 APPR: XJISONG	GENERAL TOLERANCES (UNLESS SPECIFIED) ANGULAR TOL ± 0.5 °		DIMENSION UNITS MM	SCALE 4:1				
		4 PLACES ±	DRWN BY TZHOU07	DATE 2016/03/25	698MHZ-2.7GHZ FULL LTE SMT ANTENNA				
		3 PLACES ± 0.2	CHK'D BY YXGAO04	DATE 2016/05/24			PRODUCT CUSTOMER DRAWING		
		2 PLACES ± 0.3	APPR BY CYU08	DATE 2016/07/14					SERIES 146200
1 PLACE ± 0.5	DRAFT WHERE APPLICABLE MUST REMAIN WITHIN DIMENSIONS	DRAWING SIZE A3	THIRD ANGLE PROJECTION 	DOCUMENT NUMBER 1462000001	DOC TYPE PSD	DOC PART 000	SHEET NUMBER 1 OF 2		
0 PLACES ± 1.0	C2	REV	REV	REV	REV	REV	REV	REV	REV

RELEASE STATUS	P1	RELEASE DATE	29.12.2017	04:01:46
----------------	----	--------------	------------	----------

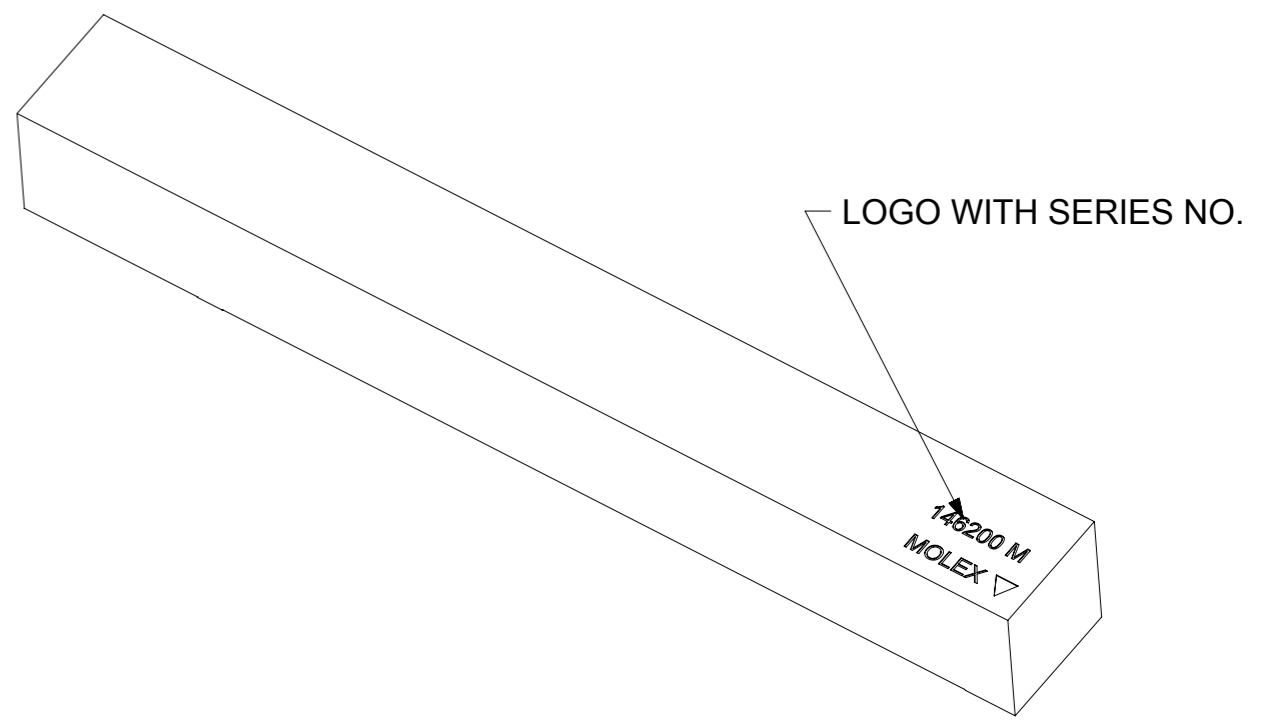
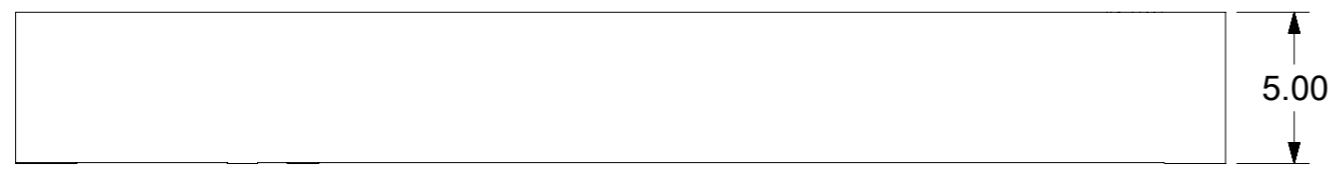
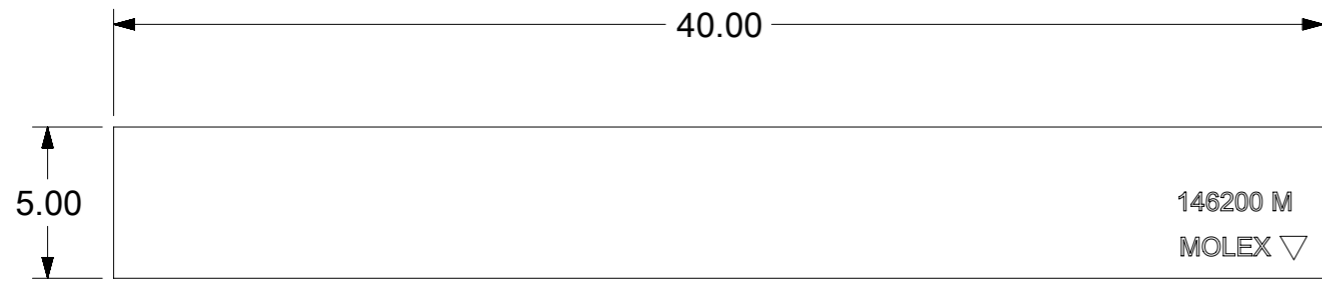

3D VIEW

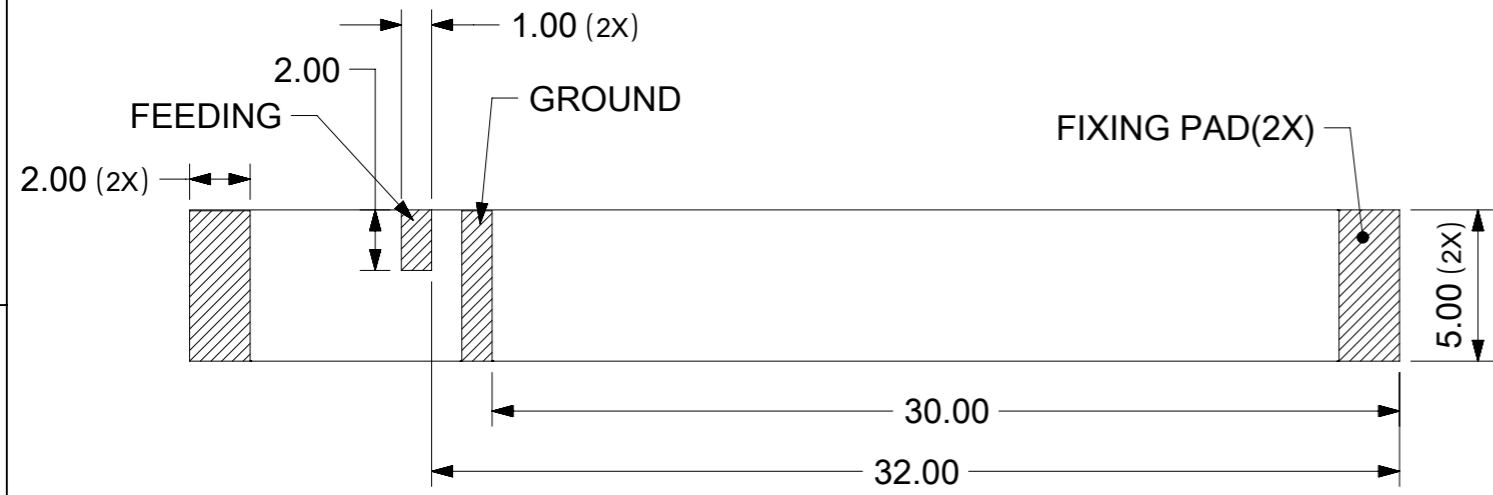

PADS OF PRODUCT FOR SOLDER

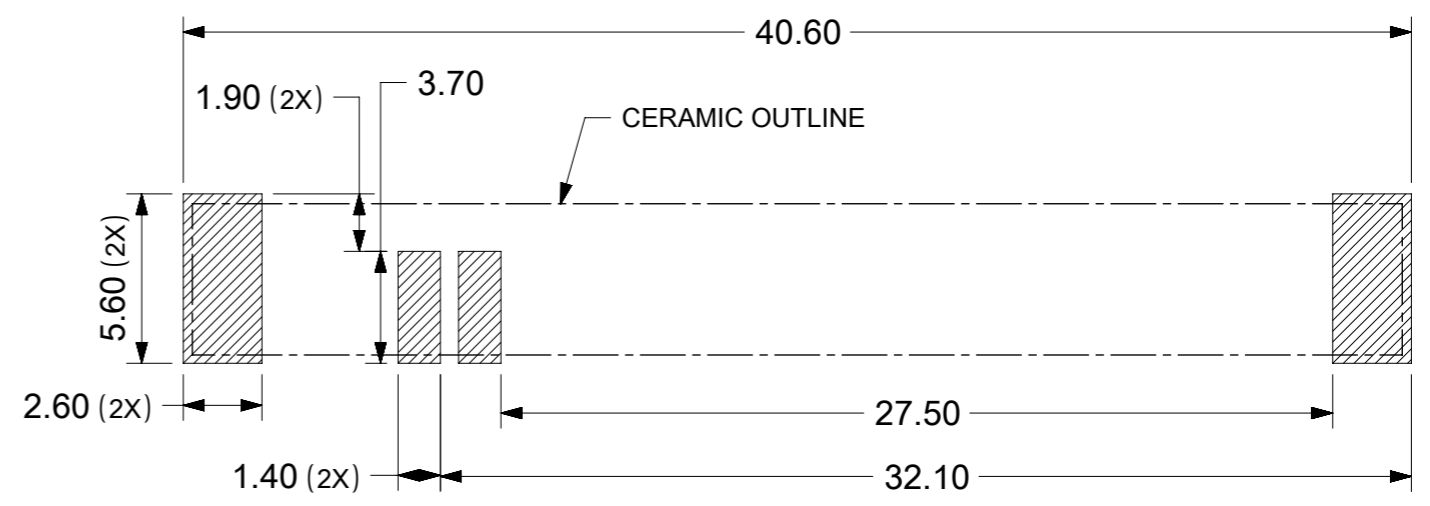

RECOMMENDED PCB LAYOUT

- NOTES:
1. MATERIAL: CERAMIC, P/N: 1462000011
 2. PATTERN: Ag PLATED, THICKNESS 6-11um
 3. PACKAGE SPEC. REFER TO PK OF 1462000001
 4. PRODUCT SPEC. REFER TO PS OF 1462000001
 5. APPLICATION SPEC. REFER TO AS OF 1462000001
 6. SUGGEST TO USE RED GLUE UNDER PART BEFORE SMT IF APPLICATION CONDITION IS STRICT

THIS DRAWING CONTAINS INFORMATION THAT IS PROPRIETARY TO MOLEX ELECTRONIC TECHNOLOGIES, LLC AND SHOULD NOT BE USED WITHOUT WRITTEN PERMISSION															
QUALITY SYMBOLS		GENERAL TOLERANCES (UNLESS SPECIFIED)				DIMENSION UNITS		SCALE							
▽A	= 0	ANGULAR TOL ± 0.5 °				MM		4:1							
▽E	= 0	4 PLACES ±		TZHOU07		DATE		698MHZ-2.7GHZ FULL LTE SMT ANTENNA							
▽F	= 0	3 PLACES ± 0.2		CHK'D BY		DATE									
▽G	= 0	2 PLACES ± 0.3		YXGAO04		2016/05/24		PRODUCT CUSTOMER DRAWING							
▽H	= 0	1 PLACE ± 0.5		APPR BY		DATE									
▽I	= 0	0 PLACES ± 1.0		CYU08		2016/07/14		SERIES		MATERIAL NUMBER		CUSTOMER			
▽J	= 0	DRAFT WHERE APPLICABLE MUST REMAIN WITHIN DIMENSIONS				DRAWING SIZE		THIRD ANGLE PROJECTION		146200		GENERAL MARKET			
▽K	= 0					A3				DOCUMENT NUMBER		DOC TYPE		DOC PART	
▽L	= 0	C2		REV		3		1462000001		PSD		000		2 OF 2	