

CIRCUIT SIZE	DIM. -A-	DIM. -B-	DIM. -C-
04	.512/13.00	.118/3.00	.472/12.00
06	.630/16.00	.236/6.00	.590/15.00
08	.748/19.00	.354/9.00	.709/18.00
10	.866/22.00	.472/12.00	.827/21.00
12	.984/25.00	.590/15.00	.945/24.00
14	1.102/28.00	.709/18.00	1.063/27.00
16	1.220/31.00	.827/21.00	1.181/30.00
18	1.338/34.00	.945/24.00	1.299/33.00
20	1.457/37.00	1.063/27.00	1.417/36.00
22	1.575/40.00	1.181/30.00	1.535/39.00
24	1.693/43.00	1.299/33.00	1.653/42.00

SECTION Z-Z

SCALE: 20/1

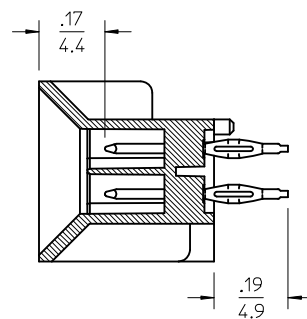
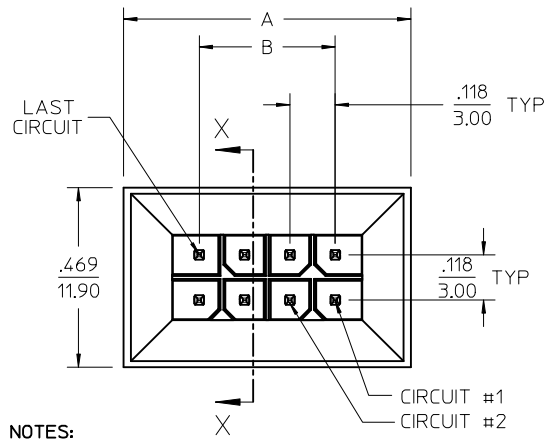

SECTION X-X

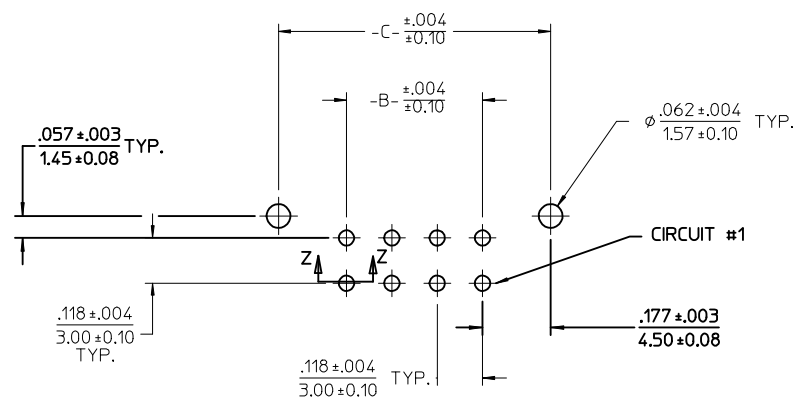

RECOMMENDED PCB LAYOUT (COMPONENT SIDE)
RECOMMENDED PCB THICKNESS .093/2.36 MIN.

- NOTES:
- MATERIALS:**
HOUSING: GLASS FILLED NYLON, UL94V-0, COLOR: BLACK.
TERMINALS: COPPER ALLOY.
 - FINISH:**
A = .000200/(0.00508) MIN. BRIGHT TIN OVER .000050/(0.00127) MIN. NICKEL.
B = .000015/(0.00038) MIN. GOLD IN SELECTIVE AREA AND .00010/(0.0025) MIN MATTE TIN ON PCB TAILS BOTH OVER .000050/(0.0013) NICKEL OVERALL.
C = .000030/(0.00075) MIN. GOLD IN SELECTIVE AREA AND .00010/(0.0025) MIN MATTE TIN ON PCB TAILS BOTH OVER .000050/(0.0013) NICKEL OVERALL.
D = .000200/(0.00508) MIN. MATTE TIN IN CONTACT AREA AND .000100/(0.00254) MIN MATTE TIN ON PCB TAILS BOTH OVER .000050/(0.00127) MIN. NICKEL OVERALL.
 - PRODUCT SPECIFICATION:** PS-44300-001
 - PACKAGING SPECIFICATION:** PK-45280-002.
 - THIS ASSEMBLY MATES WITH MOLEX BMI PANEL MOUNT RECEPTACLE SERIES 44133 WITH FEMALE CRIMP TERMINAL SERIES 43030 OR 46235, OR BMI RECEPTACLE HEADER SERIES 44764 (RIGHT ANGLE) AND 44769 (VERTICAL).
 - THIS HEADER REQUIRES A MOLEX INSERTION TOOL (62200-8400) TO PROPERLY INSTALL IT TO THE PCB.
 - THIS PART CONFORMS TO CLASS B REQUIREMENTS OF COSMETIC SPECIFICATION PS-45499-002.
 - TEXT ON PART IS FOR REFERENCE ONLY. TEXT AND TEXT LOCATION MAY VARY DEPENDING ON PART NUMBER AND/OR TOOL.

UPDATE FACTORY ID IEC NO: UCP2017-2563 DR:WINZHARPER 2017/06/02 CHKD: APPR:FSMITH 2017/09/29	QUALITY SYMBOLS 	GENERAL TOLERANCES (UNLESS SPECIFIED)		DIMENSION STYLE IN/MM		SCALE 4:1	DESIGN UNITS METRIC	THIRD ANGLE PROJECTION		
		4 PLACES ± --- ± ---	3 PLACES ± --- ± .010	2 PLACES ± 0.25 ± .015	1 PLACE ± 0.38 ± ---	0 PLACE ± ±	DRAWN BY RHOLTS	DATE 2004/07/20	TITLE MICRO-FIT (3.0) DUAL ROW VERTICAL BMI CPI HEADER-ASSY, LEAD-FREE DOCUMENT NO. SD-45280-002 SHEET NO. 1 OF 2	
		DRAFT WHERE APPLICABLE MUST REMAIN WITHIN DIMENSIONS					CHECKED BY LSCHMIDT	DATE 2004/07/20		
		ANGULAR ±1/2°					APPROVED BY FSMITH	DATE 2004/07/20		
SEE CHART					MATERIAL NO.					

PLATING OPTION: A		PLATING OPTION: B		PLATING OPTION: C		PLATING OPTION: D	
MATERIAL NUMBER	CIRCUIT SIZE	MATERIAL NUMBER	CIRCUIT SIZE	MATERIAL NUMBER	CIRCUIT SIZE	MATERIAL NUMBER	CIRCUIT SIZE
452800401	04	452800452	04	452800453	04	452800404	04
452800601	06	452800652	06	452800653	06	452800604	06
452800801	08	452800852	08	452800853	08	452800804	08
452801001	10	452801052	10	452801053	10	452801004	10
452801201	12	452801252	12	452801253	12	452801204	12
452801401	14	452801452	14	452801453	14	452801404	14
452801601	16	452801652	16	452801653	16	452801604	16
452801801	18	452801852	18	452801853	18	452801804	18
452802001	20	452802052	20	452802053	20	452802004	20
452802201	22	452802252	22	452802253	22	452802204	22
452802401	24	452802452	24	452802453	24	452802404	24

POLARIZATION LAYOUT
4-24 CIRCUITS

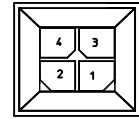

4 CIRCUIT

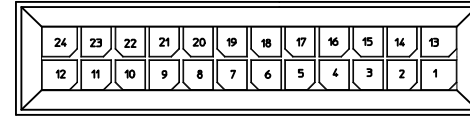

24 CIRCUIT

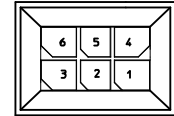

6 CIRCUIT

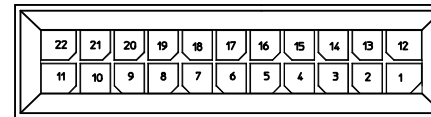

22 CIRCUIT

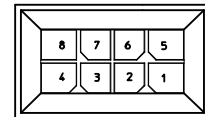

8 CIRCUIT

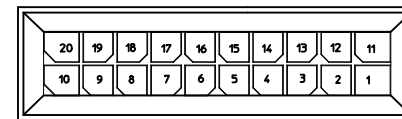

20 CIRCUIT

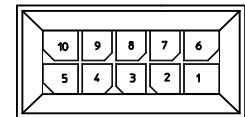

10 CIRCUIT

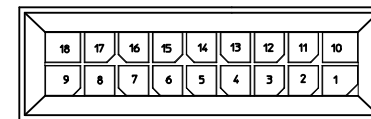

18 CIRCUIT

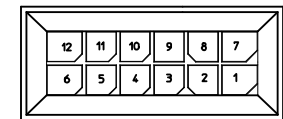

12 CIRCUIT

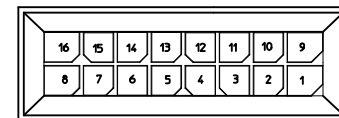

16 CIRCUIT

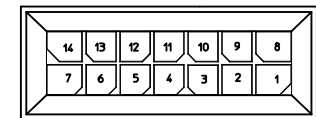

14 CIRCUIT

SEE SHEET 1 EC NO: UCP2017-2563 DRAWN: ZHARPER 2017/06/02 CHKD: APPR: FSMITH 2017/09/29	QUALITY SYMBOLS	GENERAL TOLERANCES (UNLESS SPECIFIED)	DIMENSION STYLE IN/MM	SCALE 1:1	DESIGN UNITS METRIC	THIRD ANGLE PROJECTION
	▽=0	mm	DRAWN BY RHOLTS	DATE 2004/07/20	TITLE MICRO-FIT (3.0) DUAL ROW VERTICAL BMI CPI HEADER-ASSY, LEAD-FREE 	
	▽=0	INCH	CHECKED BY LSCHMIDT	DATE 2004/07/20		
	▽=0	4 PLACES ± --- ± ---	APPROVED BY FSMITH	DATE 2004/07/20		
	3 PLACES ± --- ± .010	MATERIAL NO. SEE CHART	DOCUMENT NO. SD-45280-002			
	2 PLACES ± 0.25 ± .015	ANGULAR ±1/2°	DRAFT WHERE APPLICABLE MUST REMAIN WITHIN DIMENSIONS		SHEET NO. 2 OF 2	
	1 PLACE ± 0.38 ± ---		THIS DRAWING CONTAINS INFORMATION THAT IS PROPRIETARY TO MOLEX INCORPORATED AND SHOULD NOT BE USED WITHOUT WRITTEN PERMISSION			
	0 PLACE ± ±					