

NHD-4.3-480272EF-ASXV#

TFT (Thin-Film-Transistor) Color Liquid Crystal Display Module

| | |
|---------|--------------------------------------|
| NHD- | Newhaven Display |
| 4.3- | 4.3" Diagonal |
| 480272- | 480xRGBx272 Pixels |
| EF- | Model |
| A- | Built-in Driver / No Controller |
| S- | High Brightness, White LED Backlight |
| X- | TFT |
| V- | MVA Type, Wide Temperature |
| #- | RoHS Compliant |

Newhaven Display International, Inc.

2661 Galvin Ct.

Elgin IL, 60124

Ph: 847-844-8795

Fax: 847-844-8796

www.newhavendisplay.com

nhtech@newhavendisplay.com

nhsales@newhavendisplay.com

Document Revision History

| Revision | Date | Description | Changed by |
|----------|-----------|---|------------|
| 0 | 4/29/2014 | Initial Release | ML |
| 1 | 6/24/2014 | Timing characteristics updated | ML |
| 2 | 8/11/15 | Part number changed from ATXV#-3 to ASXV# | AK |
| 3 | 12/21/15 | Added Backlight Lifetime Rating, Datasheet Reformat | SB |
| 4 | 11/28/16 | Contrast Ratio & Supply Current Updated | SB |
| 5 | 1/6/17 | V _{LED} Updated | SB |
| 6 | 3/31/17 | Driver IC Updated | SB |

Functions and Features

- 480xRGBx272 resolution, up to 16.7M colors
- 12-LED backlight
- 24-Bit RGB interface
- Resistive and Capacitive touch panel available

Mechanical Drawing

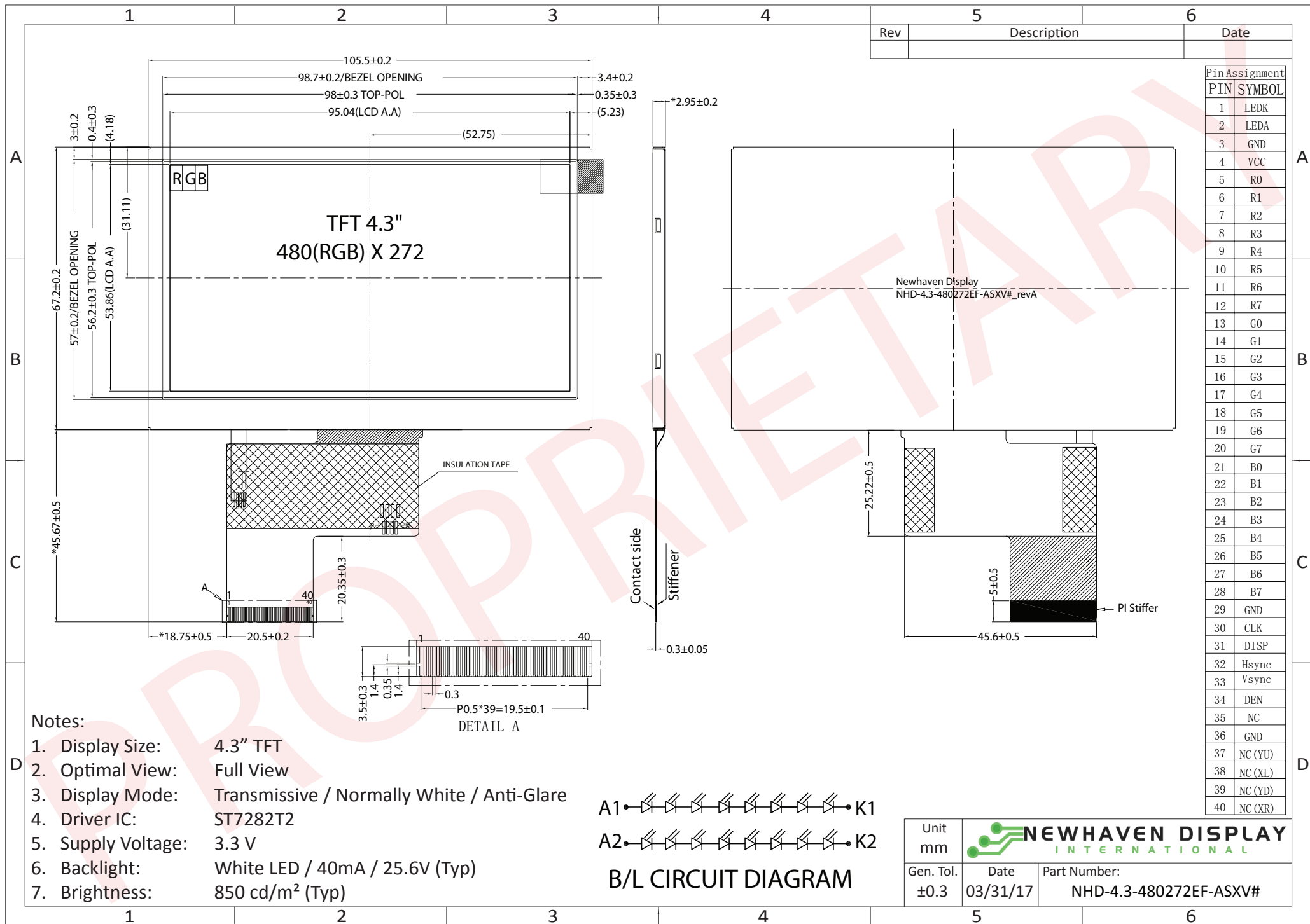

| Rev | Description | Date |
|-----|-------------|------|
| | | |

| Pin Assignment | |
|----------------|---------|
| PIN | SYMBOL |
| 1 | LEDK |
| 2 | LEDA |
| 3 | GND |
| 4 | VCC |
| 5 | R0 |
| 6 | R1 |
| 7 | R2 |
| 8 | R3 |
| 9 | R4 |
| 10 | R5 |
| 11 | R6 |
| 12 | R7 |
| 13 | G0 |
| 14 | G1 |
| 15 | G2 |
| 16 | G3 |
| 17 | G4 |
| 18 | G5 |
| 19 | G6 |
| 20 | G7 |
| 21 | B0 |
| 22 | B1 |
| 23 | B2 |
| 24 | B3 |
| 25 | B4 |
| 26 | B5 |
| 27 | B6 |
| 28 | B7 |
| 29 | GND |
| 30 | CLK |
| 31 | DISP |
| 32 | Hsync |
| 33 | Vsync |
| 34 | DEN |
| 35 | NC |
| 36 | GND |
| 37 | NC (YU) |
| 38 | NC (XL) |
| 39 | NC (YD) |
| 40 | NC (XR) |

- Notes:**
1. Display Size: 4.3" TFT
 2. Optimal View: Full View
 3. Display Mode: Transmissive / Normally White / Anti-Glare
 4. Driver IC: ST7282T2
 5. Supply Voltage: 3.3 V
 6. Backlight: White LED / 40mA / 25.6V (Typ)
 7. Brightness: 850 cd/m² (Typ)

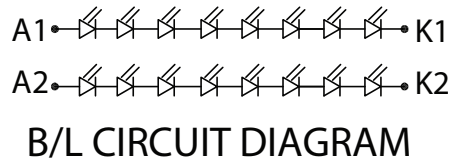

| | | |
|-------------------|--|--|
| Unit mm | NEWHAVEN DISPLAY INTERNATIONAL | |
| Gen. Tol. ±0.3 | Date 03/31/17 | Part Number: NHD-4.3-480272EF-ASXV# |

Pin Description

| Pin No. | Symbol | External Connection | Function Description |
|---------|-----------------|---------------------|---|
| 1 | LED- | Power Supply | Backlight Cathode (Ground) |
| 2 | LED+ | Power Supply | Backlight Anode (25.6V @ 40 mA) |
| 3 | GND | Power Supply | Ground |
| 4 | V _{DD} | Power Supply | Supply Voltage for LCD and logic (3.3V) |
| 5-12 | [R0-R7] | MPU | Red Data signals |
| 13-20 | [G0-G7] | MPU | Green Data signals |
| 21-28 | [B0-B7] | MPU | Blue Data signals |
| 29 | GND | Power Supply | Ground |
| 30 | CLK | MPU | Data sample Clock signal |
| 31 | DISP | MPU | Display ON/OFF signal |
| 32 | HSYNC | MPU | Line synchronization signal |
| 33 | VSYNC | MPU | Frame synchronization signal |
| 34 | DEN | MPU | Data Enable signal |
| 35 | NC | - | No Connect |
| 36 | GND | Power Supply | Ground |
| 37 | NC | - | No Connect |
| 38 | NC | - | No Connect |
| 39 | NC | - | No Connect |
| 40 | NC | - | No Connect |

Recommended LCD connector: 0.5mm pitch 40-Conductor FFC. Molex p/n: 54132-4062

Backlight connector: on LCD connector **Mates with:** ---

Electrical Characteristics

| Item | Symbol | Condition | Min. | Typ. | Max. | Unit |
|-----------------------------|-----------|--|----------------|--------|----------------|------|
| Operating Temperature Range | T_{OP} | Absolute Max | -20 | - | +70 | °C |
| Storage Temperature Range | T_{ST} | Absolute Max | -30 | - | +80 | °C |
| Supply Voltage | V_{DD} | - | 3.0 | 3.3 | 3.6 | V |
| Supply Current | I_{DD} | $V_{DD} = 3.3V$ | 12 | 25 | 50 | mA |
| "H" level input | V_{IH} | - | $0.7 * V_{DD}$ | - | V_{DD} | V |
| "L" level input | V_{IL} | - | V_{SS} | - | $0.3 * V_{DD}$ | V |
| Backlight Supply Current | I_{LED} | - | - | 40 | 50 | mA |
| Backlight Supply Voltage | I_{LED} | $I_{LED} = 40mA$ | 22.4 | 25.6 | 27.2 | mV |
| Backlight Lifetime* | - | $I_{LED} = 40mA$ $T_{OP} = 25^{\circ}C$ | 20,000 | 50,000 | - | Hrs. |

*Backlight is current driven; do not supply more than 50 mA. Backlight lifetime is rated as Hours until **half-brightness**, under normal operating conditions.

Optical Characteristics

| Item | Symbol | Condition | Min. | Typ. | Max. | Unit | |
|------------------------|-------------|-------------------|------------------------|-------|-------|-------------------|----|
| Optimal Viewing Angles | Top | $\phi Y+$ | CR ≥ 10 | - | 75 | - | ° |
| | Bottom | $\phi Y-$ | | - | 75 | - | ° |
| | Left | $\theta X-$ | | - | 75 | - | ° |
| | Right | $\theta X+$ | | - | 75 | - | ° |
| Contrast Ratio | CR | - | 400 | 500 | - | - | |
| Luminance | L_V | $I_{LED} = 40 mA$ | 680 | 850 | - | cd/m ² | |
| Response Time | Rise + Fall | T_R+T_F | $T_{OP} = 25^{\circ}C$ | - | 20 | 30 | ms |
| Chromaticity | Red | X_R | - | 0.535 | 0.585 | 0.635 | - |
| | | Y_R | - | 0.303 | 0.353 | 0.403 | - |
| | Green | X_G | - | 0.265 | 0.315 | 0.365 | - |
| | | Y_G | - | 0.570 | 0.620 | 0.670 | - |
| | Blue | X_B | - | 0.093 | 0.143 | 0.193 | - |
| | | Y_B | - | 0.053 | 0.103 | 0.153 | - |
| White | X_W | - | 0.238 | 0.288 | 0.338 | - | |
| | Y_W | - | 0.295 | 0.345 | 0.395 | - | |

* Luminance is directly related to Backlight Supply Current.

Driver Information

Built-in Sitronix ST7282T2 Driver.

Please download specification at <http://www.newhavendisplay.com/appnotes/datasheets/LCDs/ST7282T2.pdf>

Timing Characteristics

Parallel RGB input timing requirement

| Item | | Symbol | Min. | Typ. | Max. | Unit | Remark |
|----------------|----------------|--------|------|------|------|------|-----------------------|
| DCLK Frequency | | FCLK | 9 | 12 | 15 | MHz | |
| DCLK Period | | TCLK | 10 | 50 | - | μS | R=10KΩ, 1μF |
| HSYNC | Period Time | Th | 485 | 525 | 532 | DCLK | |
| | Display Period | Thdisp | - | 480 | - | DCLK | |
| | Back Porch | Thbp | 3 | 43 | 50 | DCLK | By H_Blanking Setting |
| | Front Porch | Thfp | 2 | 2 | 2 | DCLK | |
| | Pulse Width | Thw | 1 | 1 | 1 | DCLK | |
| VSYNC | Period Time | Tv | 275 | 285 | 303 | H | |
| | Display Period | Tvdisp | - | 272 | - | H | |
| | Back Porch | Tvbp | 2 | 12 | 30 | H | By V_Blanking Setting |
| | Front Porch | Tvfp | 1 | 1 | 1 | H | |
| | Pulse Width | Tvw | 1 | 1 | 1 | H | |

- SYNC Mode Timing

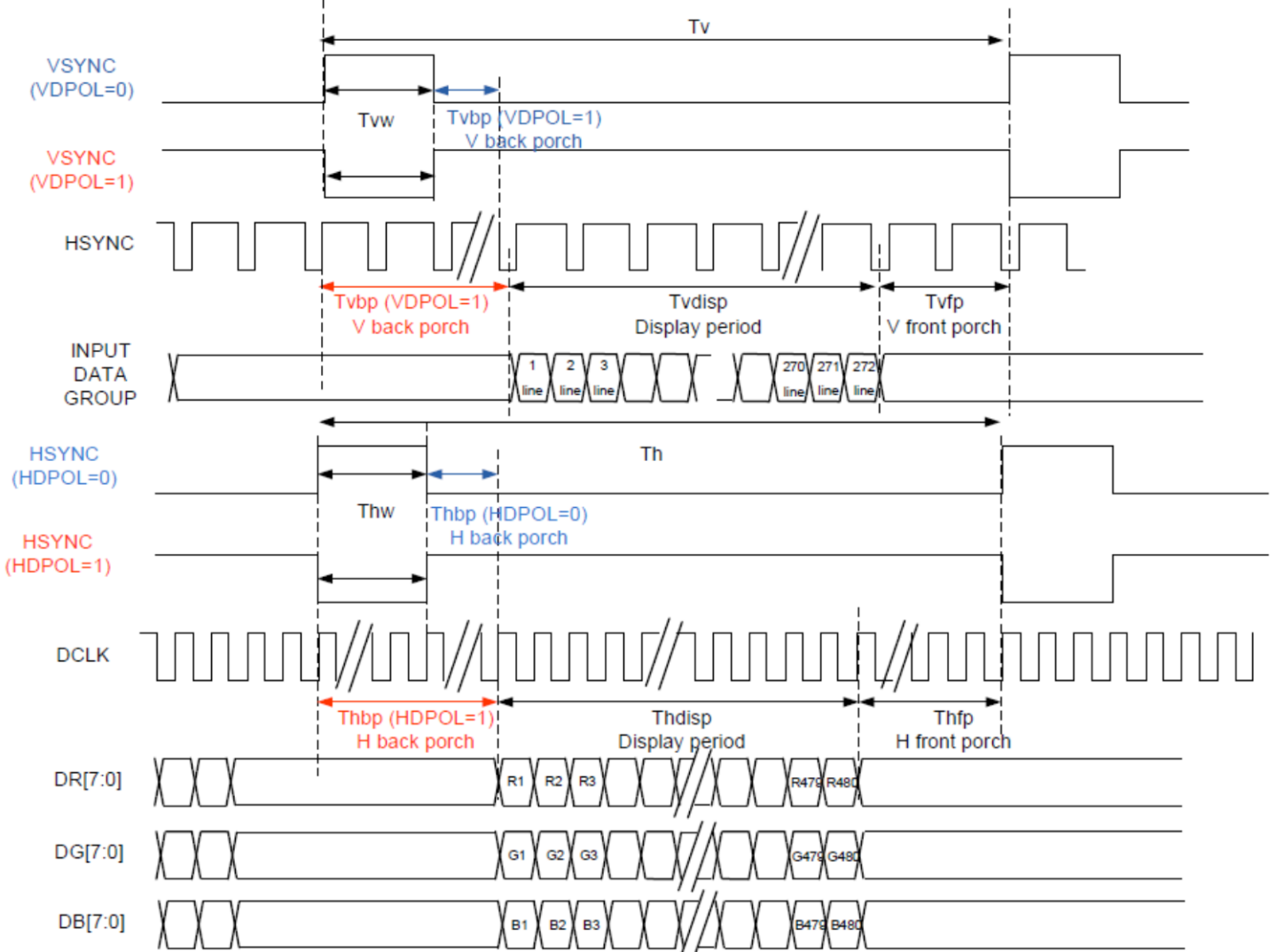

- SYNC-DE Mode Timing

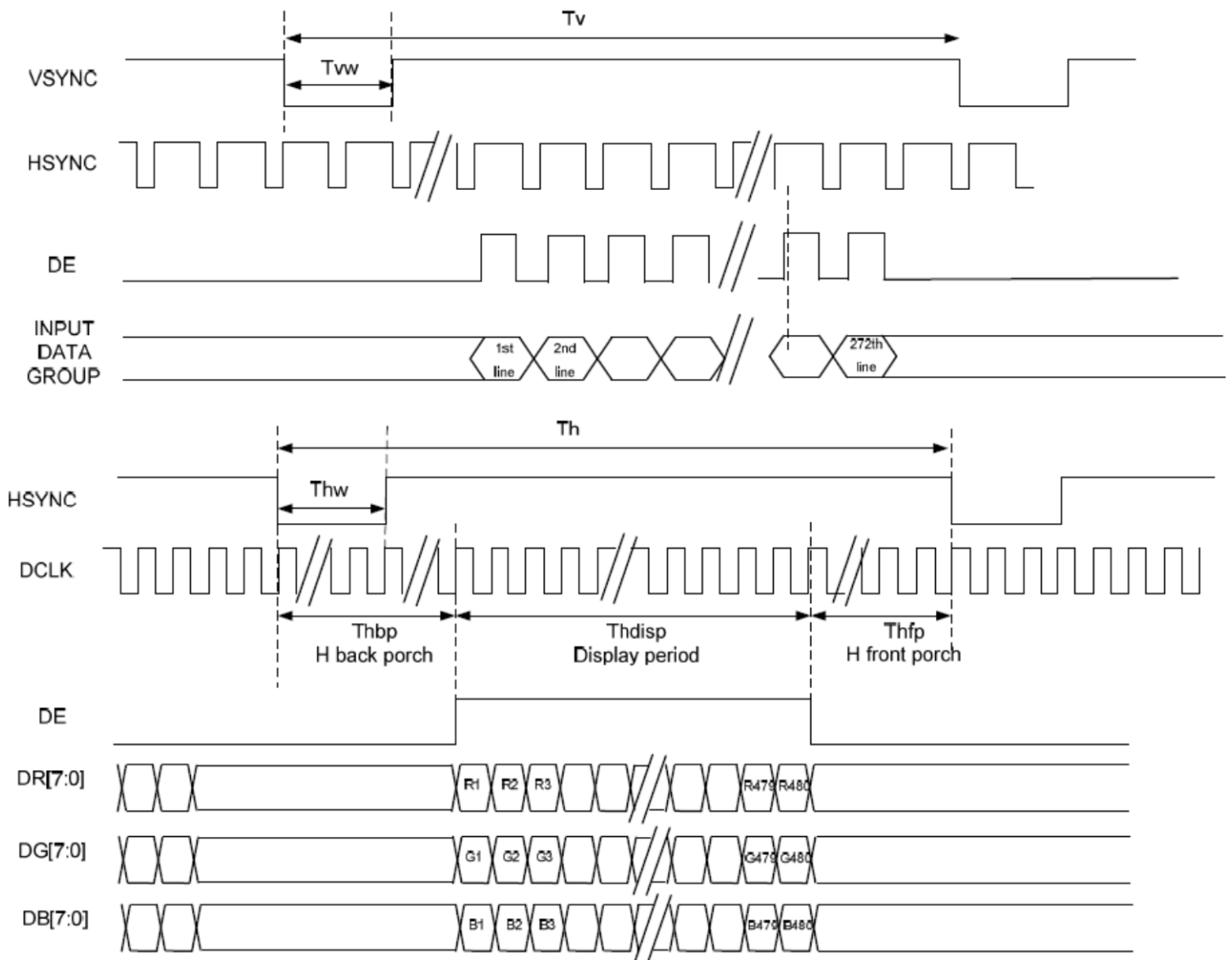

Input setup timing requirement

| Item | Symbol | Min. | Typ. | Max. | Unit | Conditions |
|--|--------|------|------|------|------|--|
| System Operation Timing | | | | | | |
| V _{DD} Power Source Slew Time | TPOR | - | - | 20 | ms | From 0V to 99% V _{DD} |
| GRB Pulse Width | tRSTW | 10 | 50 | - | μS | R=10KΩ, 1μF |
| Input / Output Timing | | | | | | |
| CLK pulse Duty | TCW | 40 | 50 | 60 | % | |
| Hsync Width | Thw | 1 | - | - | DCLK | |
| Hsync Period | Th | 50 | 60 | 65 | μS | |
| Vsync setup time | Tvst | 12 | - | - | ns | |
| Vsync hold time | Tvhd | 12 | - | - | ns | |
| Hsync setup time | Thst | 12 | - | - | ns | |
| Hsync hold time | Thhd | 12 | - | - | ns | |
| Data setup time | Tdsu | 12 | - | - | ns | |
| Data hold time | Tdhd | 12 | - | - | ns | |
| SD output stable time | Tst | - | - | 12 | μS | Output settled within +20mV Loading = 6.8k+28.2pF |
| GD output rise and fall time | Tgst | - | - | 6 | μS | Output settled (5%~95%) Loading = 4.7k+29.8pF |

- Clock And Data Input Timing Diagram

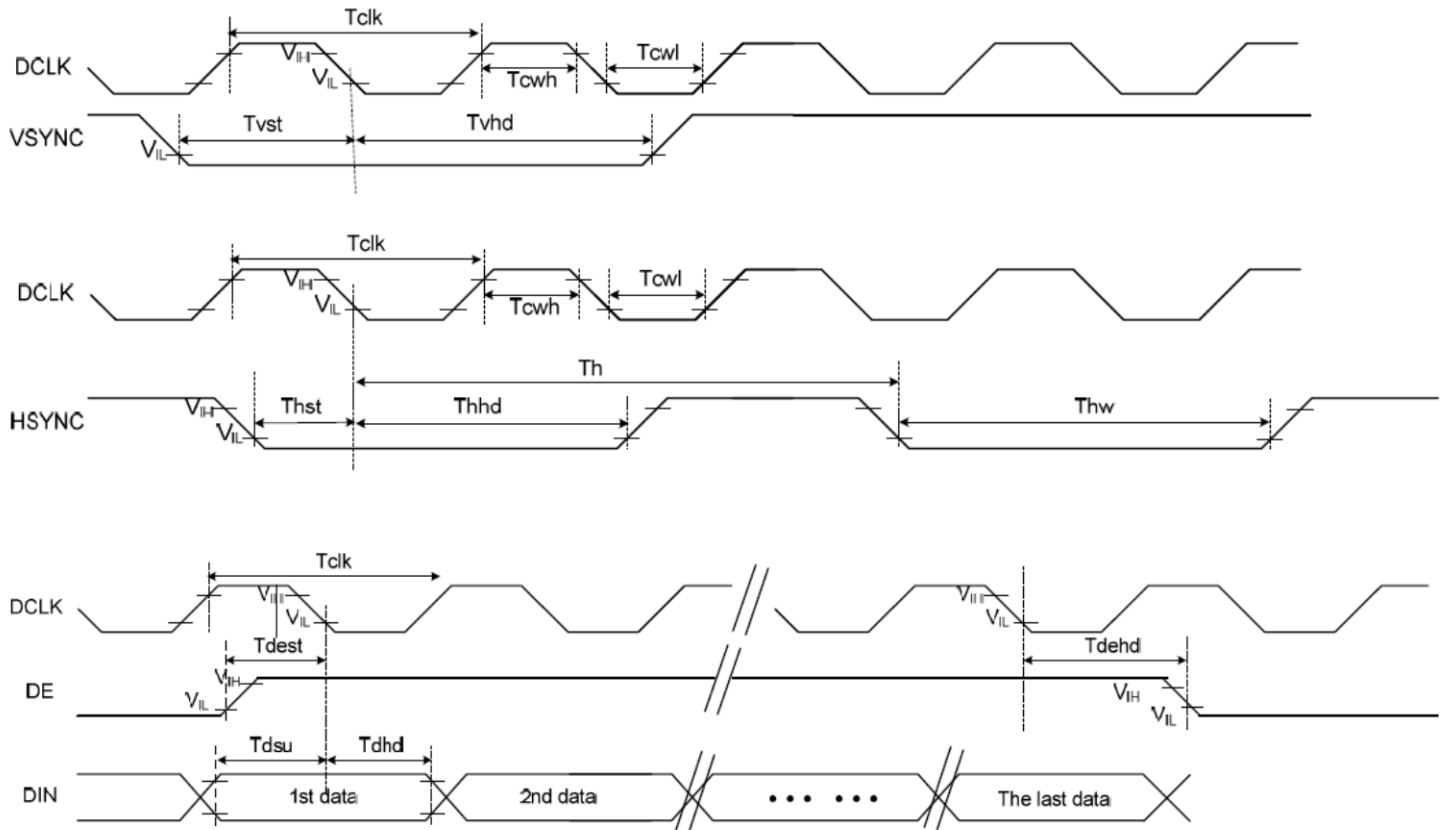

Power On/Off Sequence

- Power On Sequence

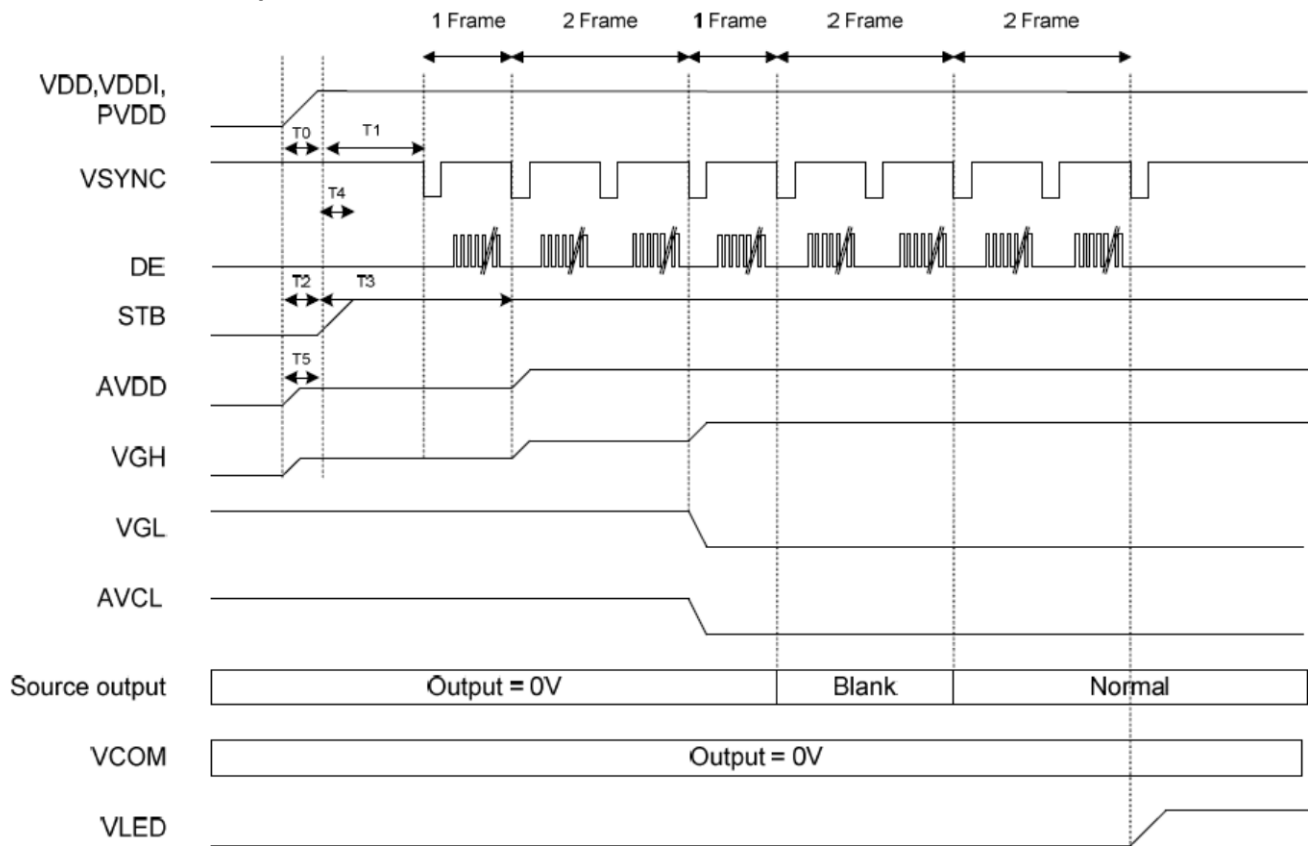

| | Description | Min. Time |
|----|--|------------------|
| T0 | Determined by the external power | |
| T1 | Time from stable VDD, VDDI, PVDD set-up to the first VSYNC | T1=0 |
| T2 | Time from AVDD=0V to AVDD=3.3V | T2=T0 |
| T3 | Time from AVDD=3.3V to AVDD=6.0V | T3=T1+ (1*Frame) |
| T4 | Time from stable VDD, VDDI, PVDD set-up to DISP asserted | T4=0 |
| T5 | Time from VGH=0V to VGH=3.3V | T5=T0 |

- **Power Off Sequence**

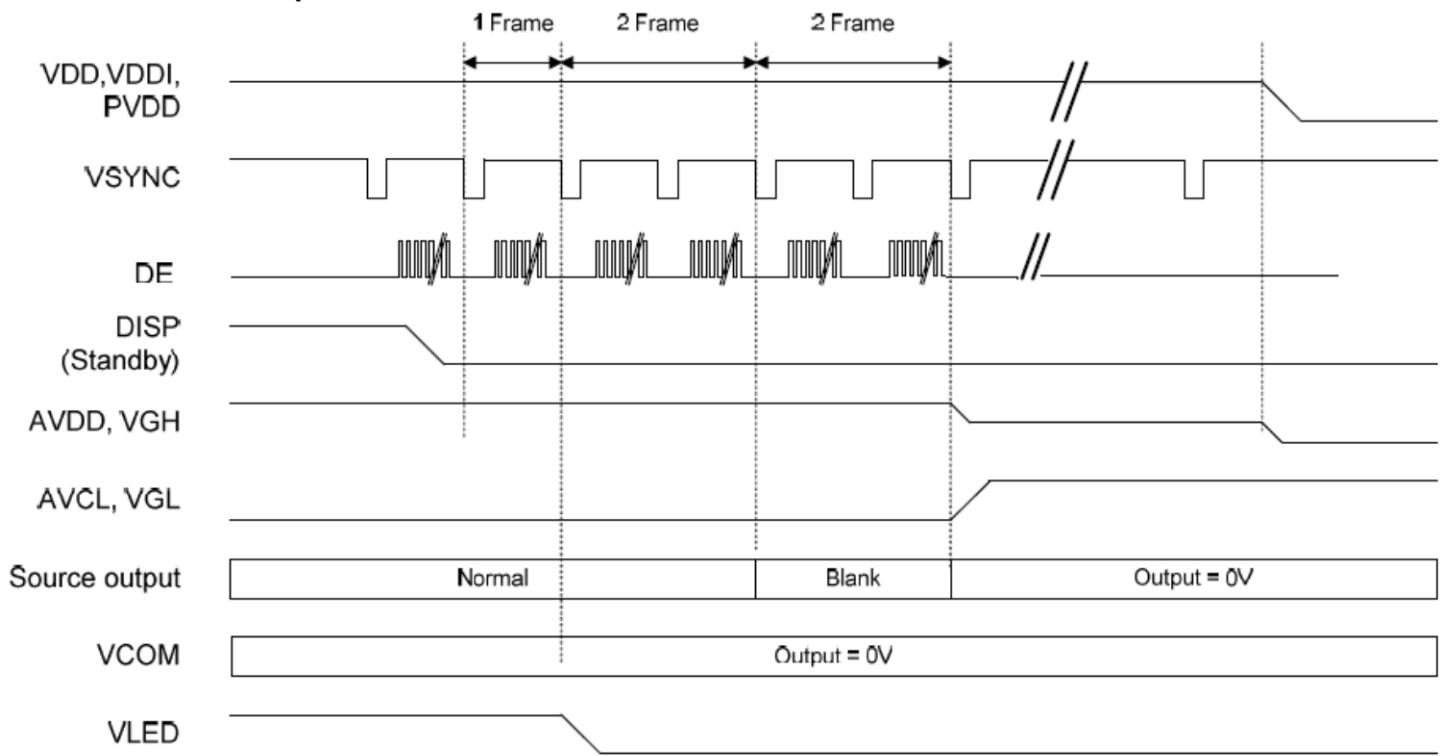

Quality Information

| Test Item | Content of Test | Test Condition | Note |
|---------------------------------------|---|---|------|
| High Temperature storage | Endurance test applying the high storage temperature for a long time. | +80°C , 96 Hrs. | 2 |
| Low Temperature storage | Endurance test applying the low storage temperature for a long time. | -30°C , 96 Hrs. | 1,2 |
| High Temperature Operation | Endurance test applying the electric stress (voltage & current) and the high thermal stress for a long time. | +70°C , 96 Hrs. | 2 |
| Low Temperature Operation | Endurance test applying the electric stress (voltage & current) and the low thermal stress for a long time. | -20°C , 96 Hrs. | 1,2 |
| High Temperature / Humidity Operation | Endurance test applying the electric stress (voltage & current) and the high thermal with high humidity stress for a long time. | +50°C , 90% RH , 96 Hrs. | 1,2 |
| Thermal Shock resistance | Endurance test applying the electric stress (voltage & current) during a cycle of low and high thermal stress. | -20°C,60min -> 25°C,5min ->70°C,60min = 1 cycle 20 cycles | - |
| Vibration test | Endurance test applying vibration to simulate transportation and use. | 10-50Hz , 15mm amplitude. 30 Min. Each Direction X,Y,Z | 3 |
| Static electricity test | Endurance test applying electric static discharge. | Air: V _S =±8KV, Contact: V _S =±4KV R _S =330Ω C _S =150pF 5 Times | - |

Note 1: No condensation to be observed.

Note 2: Conducted after 4 hours of storage at 25°C, 0%RH.

Note 3: Test performed on product itself, not inside a container.

Precautions for using LCDs/LCMs

See Precautions at www.newhavendisplay.com/specs/precautions.pdf

Warranty Information

See Terms & Conditions at http://www.newhavendisplay.com/index.php?main_page=terms