

RF Power Field Effect Transistors

N-Channel Enhancement-Mode Lateral MOSFETs

Designed for W-CDMA base station applications with frequencies from 2110 to 2170 MHz. Suitable for FM, TDMA, CDMA and multicarrier amplifier applications. To be used in Class AB for PCN-PCS/cellular radio and WLL applications.

- Typical W-CDMA Performance: -45 dBc ACPR, 2140 MHz, 28 Volts, 5 MHz Offset/4.096 MHz BW, 15 DTCH
Output Power — 2.1 Watts
Power Gain — 13.5 dB
Efficiency — 21%
- Capable of Handling 10:1 VSWR @ 28 Vdc, 2140 MHz, 10 Watts CW Output Power

Features

- High Gain, High Efficiency and High Linearity
- Integrated ESD Protection
- Designed for Maximum Gain and Insertion Phase Flatness
- Excellent Thermal Stability
- Characterized with Series Equivalent Large-Signal Impedance Parameters
- Low Gold Plating Thickness on Leads. L Suffix Indicates 40μ" Nominal.
- RoHS Compliant.
- In Tape and Reel. R1 Suffix = 500 Units per 32 mm, 13 Inch Reel.

MRF21010LR1
MRF21010LSR1

2110-2170 MHz, 10 W, 28 V
LATERAL N-CHANNEL
BROADBAND
RF POWER MOSFETs

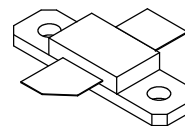

CASE 360B-05, STYLE 1
NI-360
MRF21010LR1

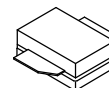

CASE 360C-05, STYLE 1
NI-360S
MRF21010LSR1

ARCHIVE INFORMATION

ARCHIVE INFORMATION

Table 1. Maximum Ratings

Rating	Symbol	Value	Unit
Drain-Source Voltage	V_{DSS}	-0.5, +65	Vdc
Gate-Source Voltage	V_{GS}	- 0.5, +15	Vdc
Total Device Dissipation @ $T_C = 25^\circ\text{C}$ Derate above 25°C	P_D	43.75 0.25	W W/ $^\circ\text{C}$
Storage Temperature Range	T_{stg}	- 65 to +150	$^\circ\text{C}$
Case Operating Temperature	T_C	150	$^\circ\text{C}$
Operating Junction Temperature	T_J	200	$^\circ\text{C}$

Table 2. Thermal Characteristics

Characteristic	Symbol	Value	Unit
Thermal Resistance, Junction to Case	$R_{\theta JC}$	5.5	$^\circ\text{C}/\text{W}$

Table 3. ESD Protection Characteristics

Test Conditions	Class
Human Body Model	1 (Minimum)
Machine Model	M1 (Minimum)

Table 4. Electrical Characteristics ($T_C = 25^\circ\text{C}$ unless otherwise noted)

Characteristic	Symbol	Min	Typ	Max	Unit
Off Characteristics					
Drain-Source Breakdown Voltage ($V_{GS} = 0 \text{ Vdc}$, $I_D = 10 \mu\text{A}$)	$V_{(BR)DSS}$	65	—	—	Vdc
Zero Gate Voltage Drain Current ($V_{DS} = 28 \text{ Vdc}$, $V_{GS} = 0 \text{ Vdc}$)	I_{DSS}	—	—	10	μAdc
Gate-Source Leakage Current ($V_{GS} = 5 \text{ Vdc}$, $V_{DS} = 0 \text{ Vdc}$)	I_{GSS}	—	—	1	μAdc
On Characteristics					
Gate Threshold Voltage ($V_{DS} = 10 \text{ V}$, $I_D = 50 \mu\text{A}$)	$V_{GS(th)}$	2.5	3	4	Vdc
Gate Quiescent Voltage ($V_{DS} = 28 \text{ V}$, $I_D = 100 \text{ mA}$)	$V_{GS(Q)}$	2.5	4	4.5	Vdc
Drain-Source On-Voltage ($V_{GS} = 10 \text{ V}$, $I_D = 0.5 \text{ A}$)	$V_{DS(on)}$	—	0.4	0.5	Vdc
Forward Transconductance ($V_{DS} = 10 \text{ V}$, $I_D = 1 \text{ A}$)	g_{fs}	—	0.95	—	S
Dynamic Characteristics					
Reverse Transfer Capacitance ($V_{DS} = 28 \text{ Vdc}$, $V_{GS} = 0$, $f = 1 \text{ MHz}$)	C_{rss}	—	1	—	pF
Functional Tests (In Freescale Test Fixture, 50 ohm system)					
Two-Tone Common Source Amplifier Power Gain ($V_{DD} = 28 \text{ Vdc}$, $P_{out} = 10 \text{ W PEP}$, $I_{DQ} = 100 \text{ mA}$, $f_1 = 2110 \text{ MHz}$, $f_2 = 2170 \text{ MHz}$, Tone Spacing = 100 KHz)	G_{ps}	12	13.5	—	dB
Two-Tone Drain Efficiency ($V_{DD} = 28 \text{ Vdc}$, $P_{out} = 10 \text{ W PEP}$, $I_{DQ} = 100 \text{ mA}$, $f_1 = 2110 \text{ MHz}$, $f_2 = 2170 \text{ MHz}$, Tone Spacing = 100 KHz)	η	31	35	—	%
Third Order Intermodulation Distortion ($V_{DD} = 28 \text{ Vdc}$, $P_{out} = 10 \text{ W PEP}$, $I_{DQ} = 100 \text{ mA}$, $f_1 = 2110 \text{ MHz}$, $f_2 = 2170 \text{ MHz}$, Tone Spacing = 100 KHz)	IMD	—	-35	-30	dBc
Input Return Loss ($V_{DD} = 28 \text{ Vdc}$, $P_{out} = 10 \text{ W PEP}$, $I_{DQ} = 100 \text{ mA}$, $f_1 = 2110 \text{ MHz}$, $f_2 = 2170 \text{ MHz}$, Tone Spacing = 100 KHz)	IRL	—	-12	-10	dB
Output Power, 1 dB Compression Point, CW ($V_{DD} = 28 \text{ Vdc}$, $I_{DQ} = 100 \text{ mA}$, $f = 2170 \text{ MHz}$)	P1dB	—	11	—	W
Common-Source Amplifier Power Gain ($V_{DD} = 28 \text{ Vdc}$, $P_{out} = 10 \text{ W CW}$, $I_{DQ} = 100 \text{ mA}$, $f = 2170 \text{ MHz}$)	G_{ps}	—	12	—	dB
Drain Efficiency ($V_{DD} = 28 \text{ Vdc}$, $P_{out} = 10 \text{ W CW}$, $I_{DQ} = 100 \text{ mA}$, $f = 2170 \text{ MHz}$)	η	—	42	—	%

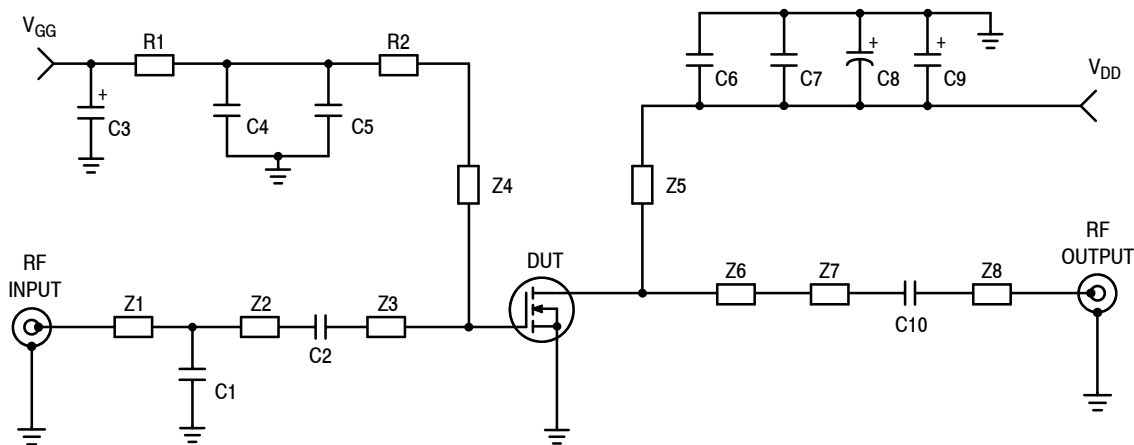

Z1	0.964" x 0.087" Microstrip	Z6	0.453" x 1.118" Microstrip
Z2	0.905" x 0.087" Microstrip	Z7	0.921" x 0.154" Microstrip
Z3	0.433" x 0.512" Microstrip	Z8	0.925" x 0.087" Microstrip
Z4	1.068" x 0.087" Microstrip	PCB	Taconic TLX8-0300, 0.030", $\epsilon_r = 2.55$
Z5	0.752" x 0.087" Microstrip		

Figure 1. MRF21010L Test Circuit Schematic

Table 5. MRF21010L Test Circuit Component Designations and Values

Part	Description	Part Number	Manufacturer
C1 *	(eared) 2.2 pF Chip Capacitor	100B2R2BW	ATC
	(earless) 1.8 pF Chip Capacitor	100B1R8BW	ATC
C2	0.5 pF Chip Capacitor	100B0R5BW	ATC
C3, C9	10 μ F, 35 V Tantalum Chip Capacitors	293D106X9035D2T	Sprague-Vishay
C4, C7	1 nF Chip Capacitors	100B102JW	ATC
C5, C6	5.6 pF Chip Capacitors	100B5R6BW	ATC
C8	470 μ F, 63 V Electrolytic Capacitor		
C10	10 pF Chip Capacitor	100B100GW	ATC
N1, N2	Type N Connector Flange Mounts	3052-1648-10	Macom
R1	1.0 k Ω Chip Resistor (0805)		
R2	12 Ω Chip Resistor (0805)		

* Piece part depending on eared / earless version of the device.

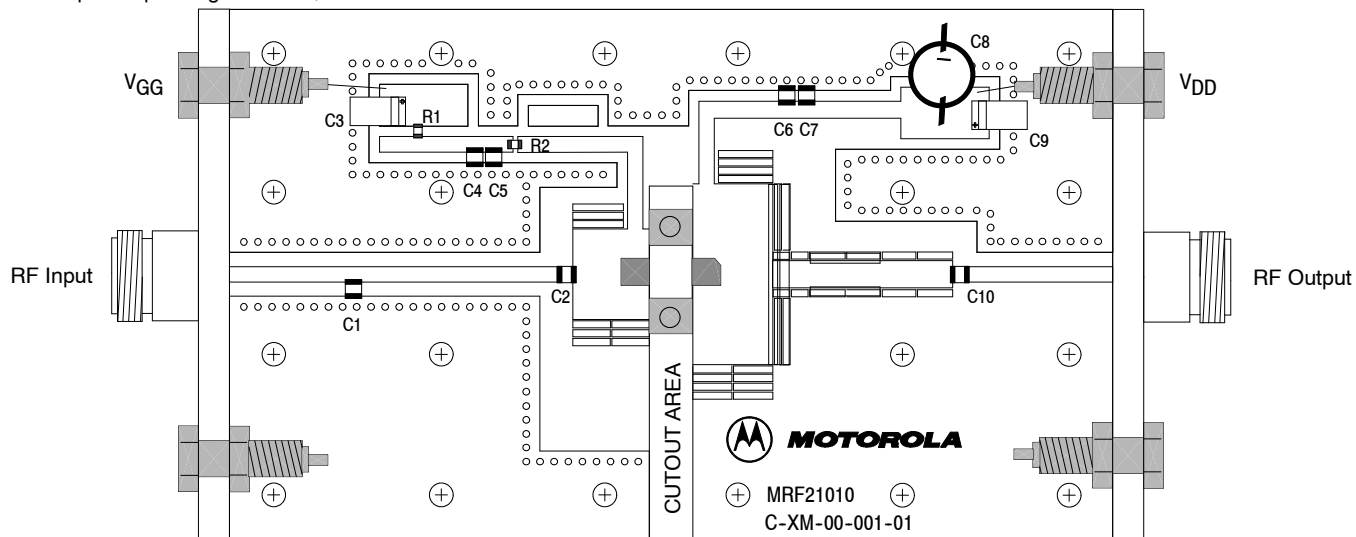

Freescle has begun the transition of marking Printed Circuit Boards (PCBs) with the Freescle Semiconductor signature/logo. PCBs may have either Motorola or Freescle markings during the transition period. These changes will have no impact on form, fit or function of the current product.

Figure 2. MRF21010L Test Circuit Component Layout

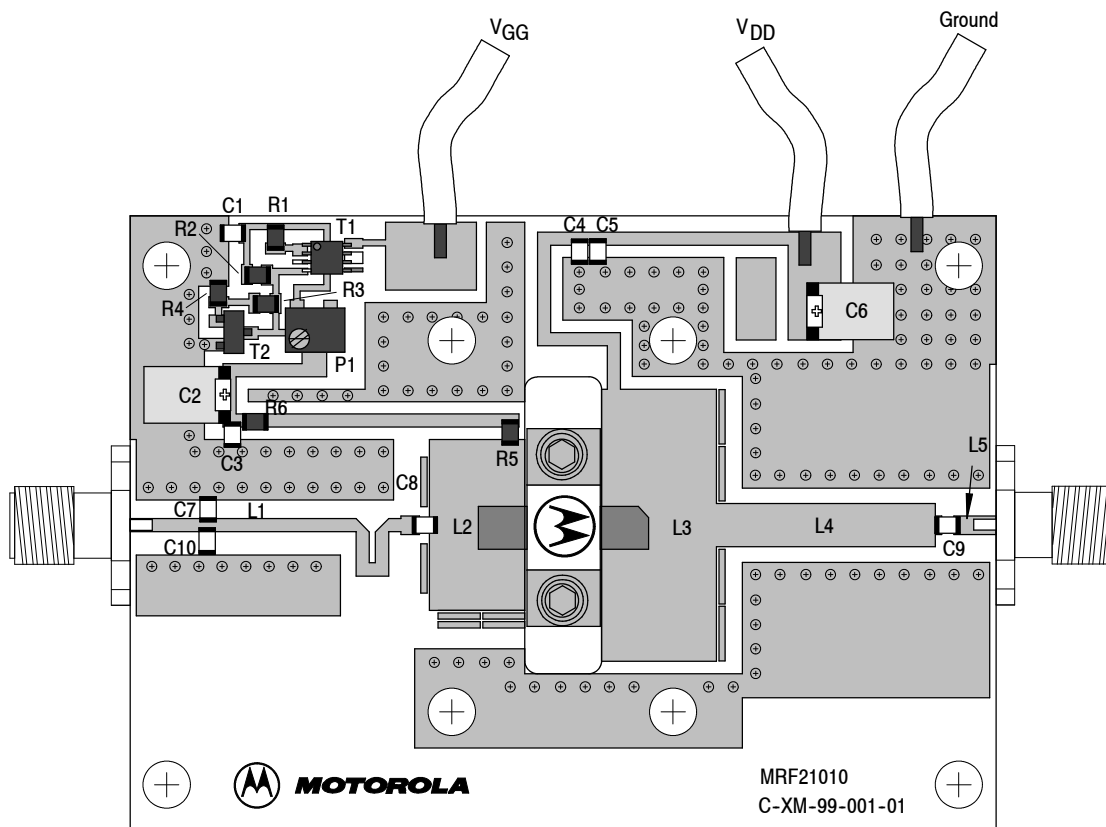

Freescale has begun the transition of marking Printed Circuit Boards (PCBs) with the Freescale Semiconductor signature/logo. PCBs may have either Motorola or Freescale markings during the transition period. These changes will have no impact on form, fit or function of the current product.

Figure 3. MRF21010L Demonstration Board Component Layout

Table 6. MRF21010L Demonstration Board Component Designations and Values

Designators	Description
C1	1 μ F Chip Capacitor (0805), AVX #08053G105ZATEA
C2, C6	10 μ F, 35 V Tantalum Capacitors, Vishay-Sprague #293D106X9035D
C3, C4	6.8 pF Chip Capacitors, ACCU-P (0805), AVX #08051J6R8CBT
C5	10 nF Chip Capacitor (0805), AVX #08055C103KATDA
C7	1.5 pF Chip Capacitor, ACCU-P (0805), AVX #08051J2R2BBT
C8, C10	0.5 pF Chip Capacitors, ACCU-P (0805), AVX #08051J0R5BBT
C9	10 pF Chip Capacitor, ACCU-P (0805), AVX #08055J100GBT
L1	19 mm \times 1.07 mm
L2	7.7 mm \times 13.8 mm
L3	9.3 mm \times 22 mm
L4	17.7 mm \times 3.5 mm
L5	3.4 mm \times 1.5 mm
R1, R6	10 Ω , 1/8 W Chip Resistors (0805)
R2, R3	1 k Ω , 1/8 W Chip Resistors (0805)
R4	2.2 k Ω , 1/8 W Chip Resistor (0805)
R5	0 Ω , 1/8 W Chip Resistor (0805)
P1	5 k Ω Potentiometer CMS Cermet Multi-Turn, Bourns #3224W
T1	Voltage Regulator, Micro-8, #LP2951
T2	Bipolar NPN Transistor, SOT-23, #BC847
PCB	Rogers RO4350, 0.5 mm, $\epsilon_r = 3.53$

TYPICAL CHARACTERISTICS

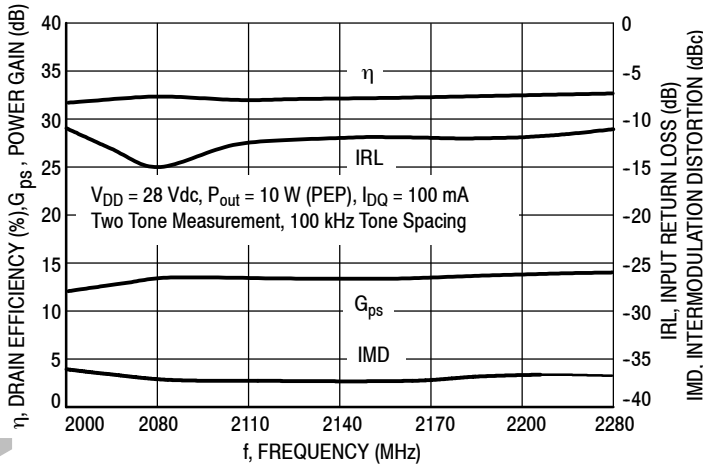

Figure 4. Class AB Broadband Circuit Performance

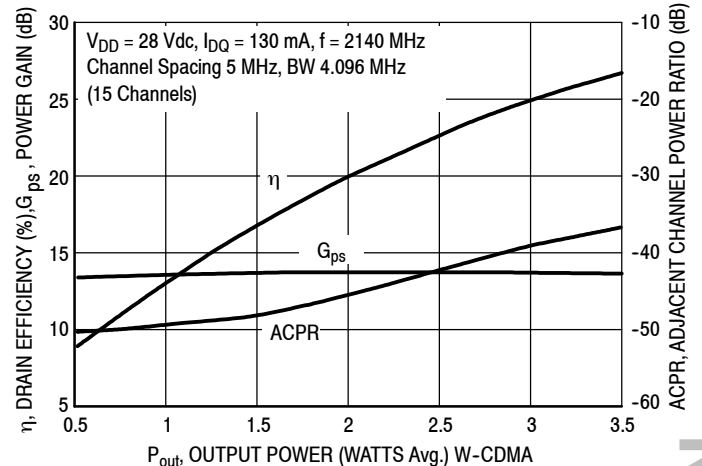

Figure 5. W-CDMA ACPR, Power Gain and Drain Efficiency versus Output Power

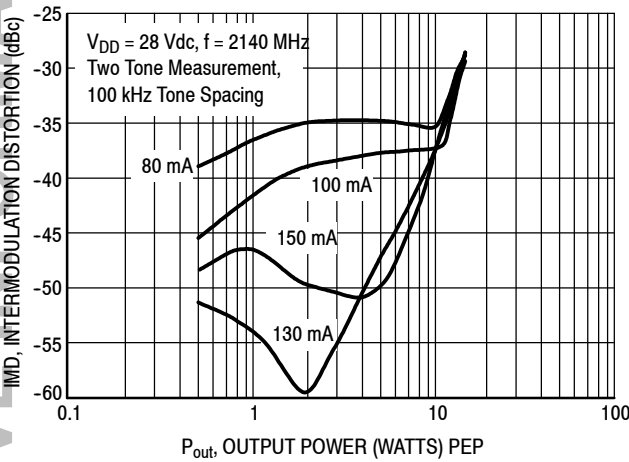

Figure 6. Intermodulation Distortion versus Output Power

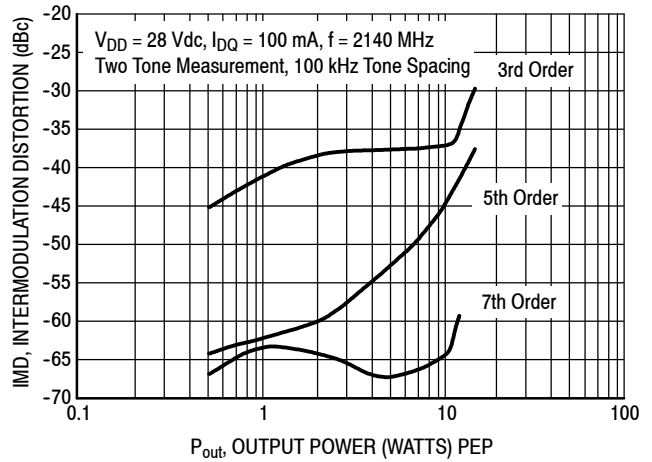

Figure 7. Intermodulation Distortion Products versus Output Power

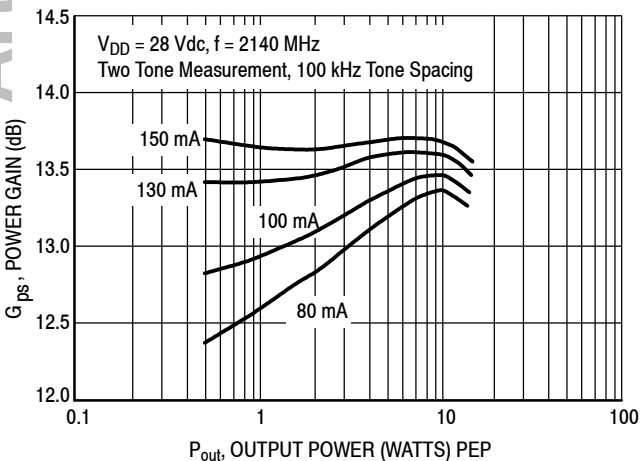

Figure 8. Power Gain versus Output Power

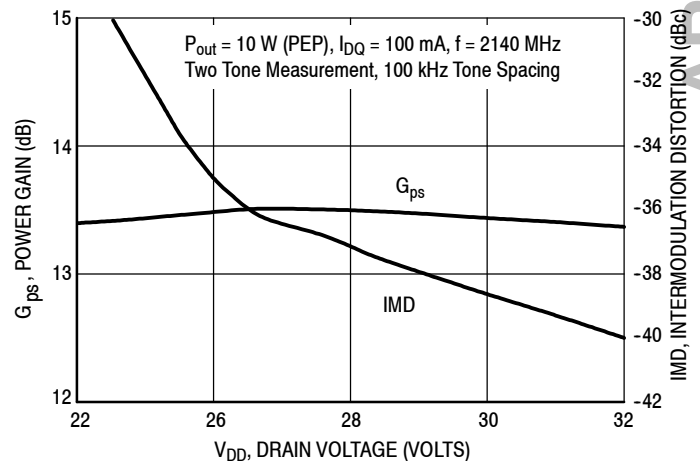
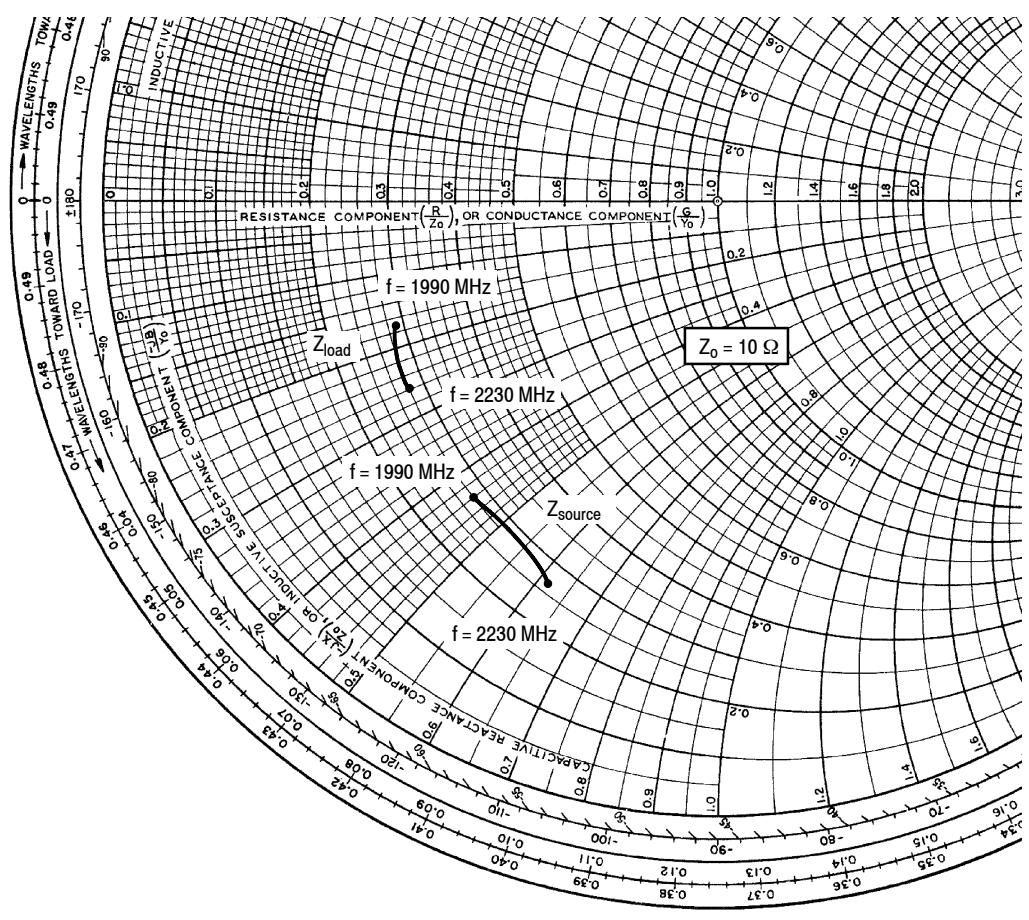

Figure 9. Intermodulation and Gain versus Supply Voltage

ARCHIVE INFORMATION

ARCHIVE INFORMATION



$V_{DD} = 28\text{ V}$, $I_{DQ} = 100\text{ mA}$, $P_{out} = 10\text{ W PEP}$

f MHz	Z_{source} Ω	Z_{load} Ω
1990	$2.85 - j4.38$	$2.93 - j1.71$
2110	$2.89 - j5.04$	$2.76 - j2.28$
2230	$2.73 - j6.19$	$2.83 - j2.59$

Z_{source} = Test circuit impedance as measured from gate to ground.

Z_{load} = Test circuit impedance as measured from drain to ground.

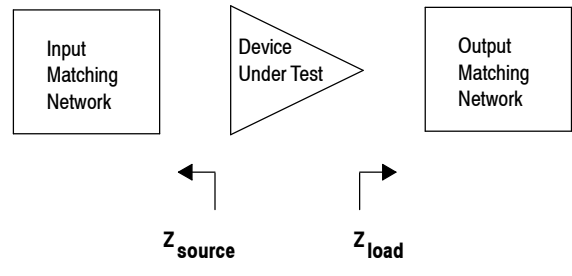
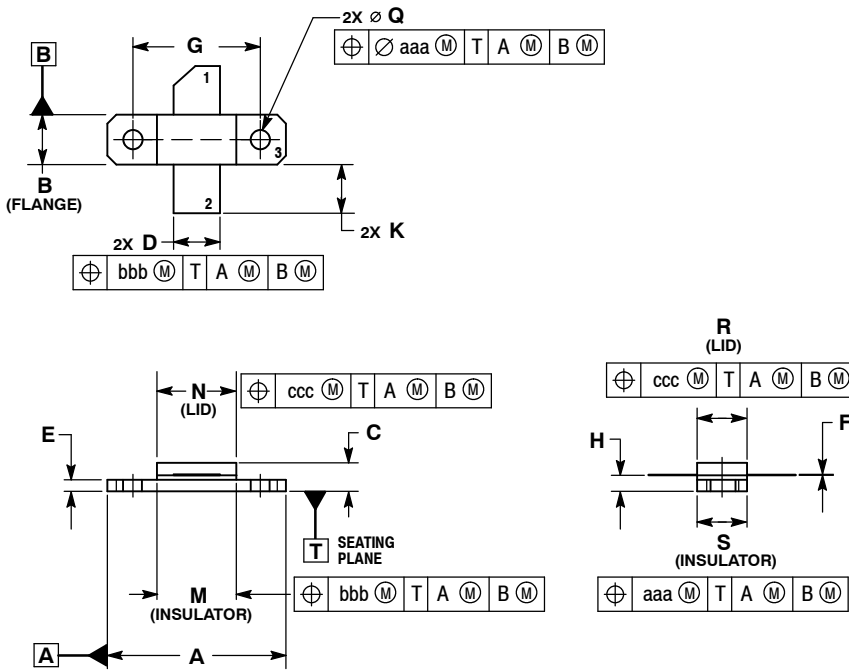

Figure 10. Series Equivalent Source and Load Impedance

PACKAGE DIMENSIONS



- NOTES:
1. INTERPRET DIMENSIONS AND TOLERANCES PER ASME Y14.5M-1994.
 2. CONTROLLING DIMENSION: INCH.
 3. DIMENSION H IS MEASURED 0.030 (0.762) AWAY FROM PACKAGE BODY.

DIM	INCHES		MILLIMETERS	
	MIN	MAX	MIN	MAX
A	0.795	0.805	20.19	20.45
B	0.225	0.235	5.72	5.97
C	0.125	0.175	3.18	4.45
D	0.210	0.220	5.33	5.59
E	0.055	0.065	1.40	1.65
F	0.004	0.006	0.10	0.15
G	0.562 BSC		14.28 BSC	
H	0.077	0.087	1.96	2.21
K	0.220	0.250	5.59	6.35
M	0.355	0.365	9.02	9.27
N	0.357	0.363	9.07	9.22
Q	0.125	0.135	3.18	3.43
R	0.227	0.233	5.77	5.92
S	0.225	0.235	5.72	5.97
aaa	0.005 REF		0.13 REF	
bbb	0.010 REF		0.25 REF	
ccc	0.015 REF		0.38 REF	

- STYLE 1:
 PIN 1. DRAIN
 2. GATE
 3. SOURCE

**CASE 360B-05
 ISSUE G
 NI-360
 MRF2101LR1**

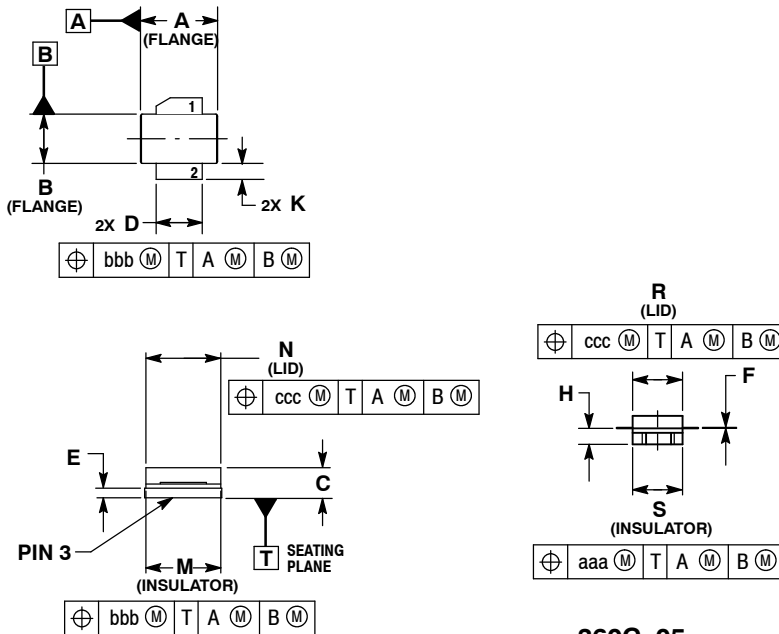

- NOTES:
1. INTERPRET DIMENSIONS AND TOLERANCES PER ASME Y14.5M-1994.
 2. CONTROLLING DIMENSION: INCH.
 3. DIMENSION H IS MEASURED 0.030 (0.762) AWAY FROM PACKAGE BODY.

DIM	INCHES		MILLIMETERS	
	MIN	MAX	MIN	MAX
A	0.375	0.385	9.53	9.78
B	0.225	0.235	5.72	5.97
C	0.105	0.155	2.67	3.94
D	0.210	0.220	5.33	5.59
E	0.035	0.045	0.89	1.14
F	0.004	0.006	0.10	0.15
H	0.057	0.067	1.45	1.70
K	0.085	0.115	2.16	2.92
M	0.355	0.365	9.02	9.27
N	0.357	0.363	9.07	9.22
R	0.227	0.23	5.77	5.92
S	0.225	0.235	5.72	5.97
aaa	0.005 REF		0.13 REF	
bbb	0.010 REF		0.25 REF	
ccc	0.015 REF		0.38 REF	

- STYLE 1:
 PIN 1. DRAIN
 2. GATE
 3. SOURCE

**360C-05
 ISSUE E
 NI-360S
 MRF2101LSR1**

How to Reach Us:

Home Page:
www.freescale.com

E-mail:
support@freescale.com

USA/Europe or Locations Not Listed:
Freescale Semiconductor
Technical Information Center, CH370
1300 N. Alma School Road
Chandler, Arizona 85224
+1-800-521-6274 or +1-480-768-2130
support@freescale.com

Europe, Middle East, and Africa:
Freescale Halbleiter Deutschland GmbH
Technical Information Center
Schatzbogen 7
81829 Muenchen, Germany
+44 1296 380 456 (English)
+46 8 52200080 (English)
+49 89 92103 559 (German)
+33 1 69 35 48 48 (French)
support@freescale.com

Japan:
Freescale Semiconductor Japan Ltd.
Headquarters
ARCO Tower 15F
1-8-1, Shimo-Meguro, Meguro-ku,
Tokyo 153-0064
Japan
0120 191014 or +81 3 5437 9125
support.japan@freescale.com

Asia/Pacific:
Freescale Semiconductor Hong Kong Ltd.
Technical Information Center
2 Dai King Street
Tai Po Industrial Estate
Tai Po, N.T., Hong Kong
+800 2666 8080
support.asia@freescale.com

For Literature Requests Only:
Freescale Semiconductor Literature Distribution Center
P.O. Box 5405
Denver, Colorado 80217
1-800-441-2447 or 303-675-2140
Fax: 303-675-2150
LDCForFreescaleSemiconductor@hibbertgroup.com

Information in this document is provided solely to enable system and software implementers to use Freescale Semiconductor products. There are no express or implied copyright licenses granted hereunder to design or fabricate any integrated circuits or integrated circuits based on the information in this document.

Freescale Semiconductor reserves the right to make changes without further notice to any products herein. Freescale Semiconductor makes no warranty, representation or guarantee regarding the suitability of its products for any particular purpose, nor does Freescale Semiconductor assume any liability arising out of the application or use of any product or circuit, and specifically disclaims any and all liability, including without limitation consequential or incidental damages. "Typical" parameters that may be provided in Freescale Semiconductor data sheets and/or specifications can and do vary in different applications and actual performance may vary over time. All operating parameters, including "Typicals", must be validated for each customer application by customer's technical experts. Freescale Semiconductor does not convey any license under its patent rights nor the rights of others. Freescale Semiconductor products are not designed, intended, or authorized for use as components in systems intended for surgical implant into the body, or other applications intended to support or sustain life, or for any other application in which the failure of the Freescale Semiconductor product could create a situation where personal injury or death may occur. Should Buyer purchase or use Freescale Semiconductor products for any such unintended or unauthorized application, Buyer shall indemnify and hold Freescale Semiconductor and its officers, employees, subsidiaries, affiliates, and distributors harmless against all claims, costs, damages, and expenses, and reasonable attorney fees arising out of, directly or indirectly, any claim of personal injury or death associated with such unintended or unauthorized use, even if such claim alleges that Freescale Semiconductor was negligent regarding the design or manufacture of the part.

Freescale™ and the Freescale logo are trademarks of Freescale Semiconductor, Inc. All other product or service names are the property of their respective owners.
© Freescale Semiconductor, Inc. 2006, 2008. All rights reserved.