



# BAP64-06

Silicon PIN diode

Rev. 4 — 28 April 2015

Product data sheet

## 1. Product profile

### 1.1 General description

Two planar PIN diodes in common anode configuration in a SOT23 small SMD plastic package.

### 1.2 Features and benefits

- High voltage, current controlled
- RF resistor for RF attenuators and switches
- Low diode capacitance
- Low diode forward resistance
- Low series inductance
- For applications up to 3 GHz
- AEC-Q101 qualified

### 1.3 Applications

- RF attenuators and switches

## 2. Pinning information

Table 1. Discrete pinning

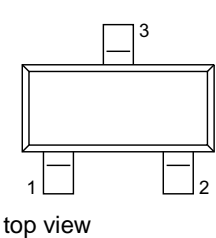
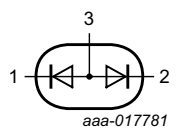
Pin	Description	Simplified outline	Symbol
1	cathode 1	 top view	
2	cathode 2		
3	common connection		

## 3. Ordering information

Table 2. Ordering information

Type number	Package		
	Name	Description	Version
BAP64-06	-	plastic surface-mounted package; 3 leads	SOT23



## 4. Marking

Table 3. Marking

Type number	Marking	Description
BAP64-06	6K*	* = t : made in Malaysia * = W : made in China

## 5. Limiting values

Table 4. Limiting values

In accordance with the Absolute Maximum Rating System (IEC 60134).  
Values are specified per diode.

Symbol	Parameter	Conditions	Min	Max	Unit
$V_R$	reverse voltage		-	175	V
$I_F$	forward current		-	100	mA
$P_{tot}$	total power dissipation	$T_{sp} = 90\text{ °C}$	-	250	mW
$T_{stg}$	storage temperature		-65	+150	°C
$T_j$	junction temperature		-65	+150	°C

## 6. Thermal characteristics

Table 5. Thermal characteristics

Symbol	Parameter	Conditions	Typ	Unit
$R_{th(j-sp)}$	thermal resistance from junction to solder point		220	K/W

## 7. Characteristics

Table 6. Characteristics

Values are specified per diode;  $T_j = 25\text{ °C}$  unless otherwise specified.

Symbol	Parameter	Conditions	Min	Typ	Max	Unit
$V_F$	forward voltage	$I_F = 50\text{ mA}$	-	0.95	1.1	V
$I_R$	reverse current	$V_R = 175\text{ V}$	-	-	10	$\mu\text{A}$
		$V_R = 20\text{ V}$	-	-	1	$\mu\text{A}$
$C_d$	diode capacitance	see <a href="#">Figure 1</a> ; $f = 1\text{ MHz}$ ;				
		$V_R = 0\text{ V}$	-	0.52	-	pF
		$V_R = 1\text{ V}$	-	0.37	-	pF
		$V_R = 20\text{ V}$	-	0.23	0.35	pF

**Table 6. Characteristics ...continued**

Values are specified per diode;  $T_j = 25\text{ }^\circ\text{C}$  unless otherwise specified.

Symbol	Parameter	Conditions	Min	Typ	Max	Unit
$r_D$	diode forward resistance	see <a href="#">Figure 2</a> ; $f = 100\text{ MHz}$ ; <a href="#">[1]</a>				
		$I_F = 0.5\text{ mA}$	-	20	40	$\Omega$
		$I_F = 1\text{ mA}$	-	10	20	$\Omega$
		$I_F = 10\text{ mA}$	-	2.0	3.8	$\Omega$
		$I_F = 100\text{ mA}$	-	0.7	1.35	$\Omega$
$\tau_L$	charge carrier life time	when switched from $I_F = 10\text{ mA}$ to $I_R = 6\text{ mA}$ ; $R_L = 100\ \Omega$ ; measured at $I_R = 3\text{ mA}$	-	1.55	-	$\mu\text{s}$
$L_S$	series inductance		-	1.4	-	nH

[1] Guaranteed on AQL basis: inspection level S4, AQL 1.0.

### 7.1 Graphical data

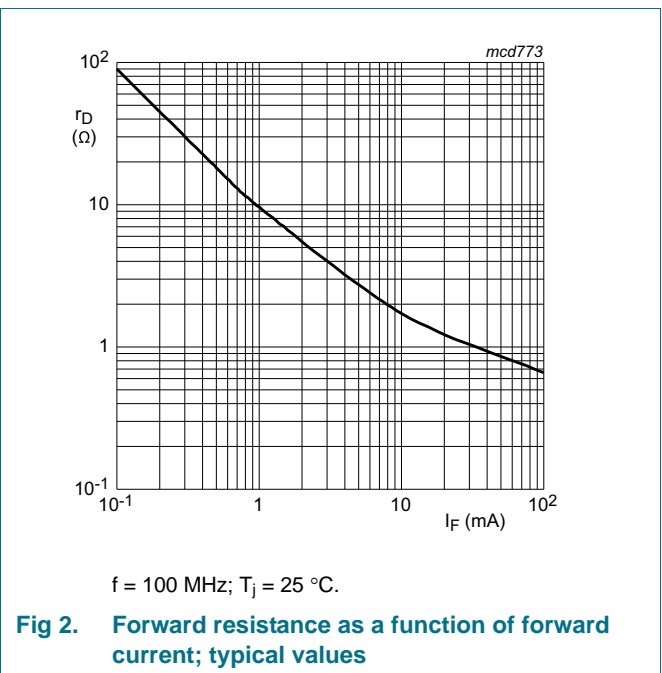
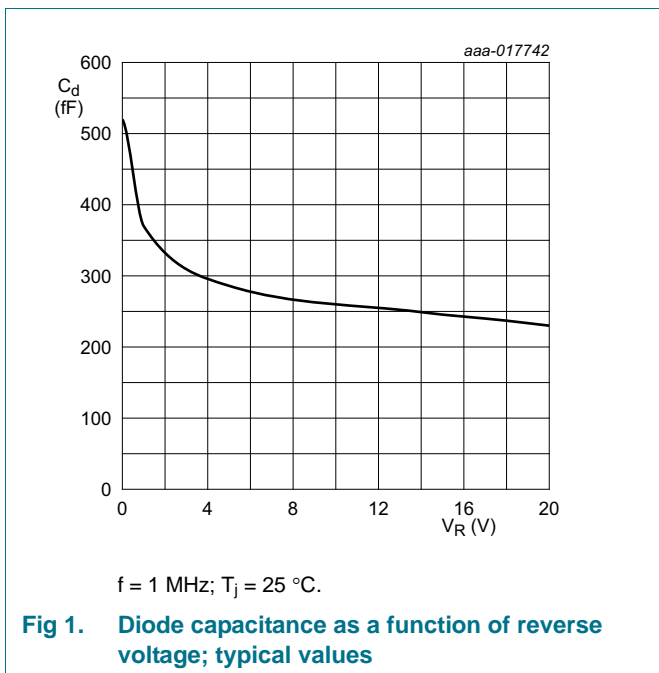

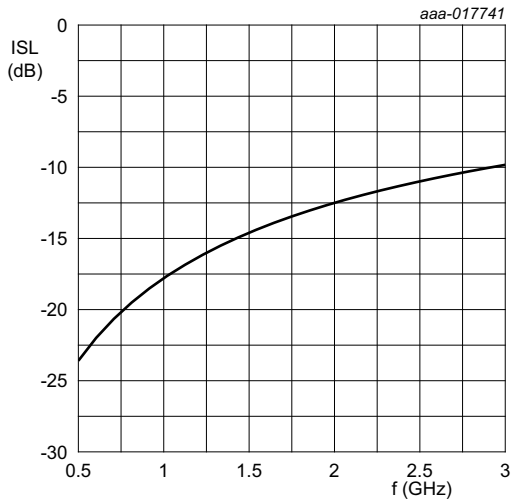

$T_{amb} = 25\text{ }^{\circ}\text{C}$   
 Diode zero biased and inserted in series with a 50  $\Omega$  stripline circuit

**Fig 3. Isolation of the diode as a function of frequency; typical values**

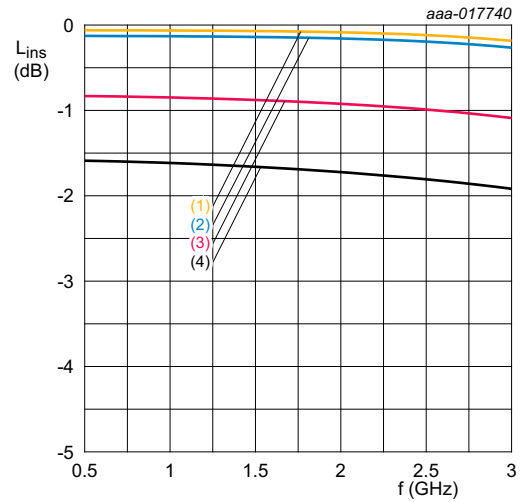

$T_{amb} = 25\text{ }^{\circ}\text{C}$   
 (1)  $I_F = 100\text{ mA}$   
 (2)  $I_F = 10\text{ mA}$   
 (3)  $I_F = 1\text{ mA}$   
 (4)  $I_F = 0.5\text{ mA}$   
 Diode inserted in series with a 50  $\Omega$  stripline circuit and biased via the analyzer Tee network

**Fig 4. Insertion loss of the diode as a function of frequency; typical values**

**8. Package outline**

Plastic surface-mounted package; 3 leads

SOT23

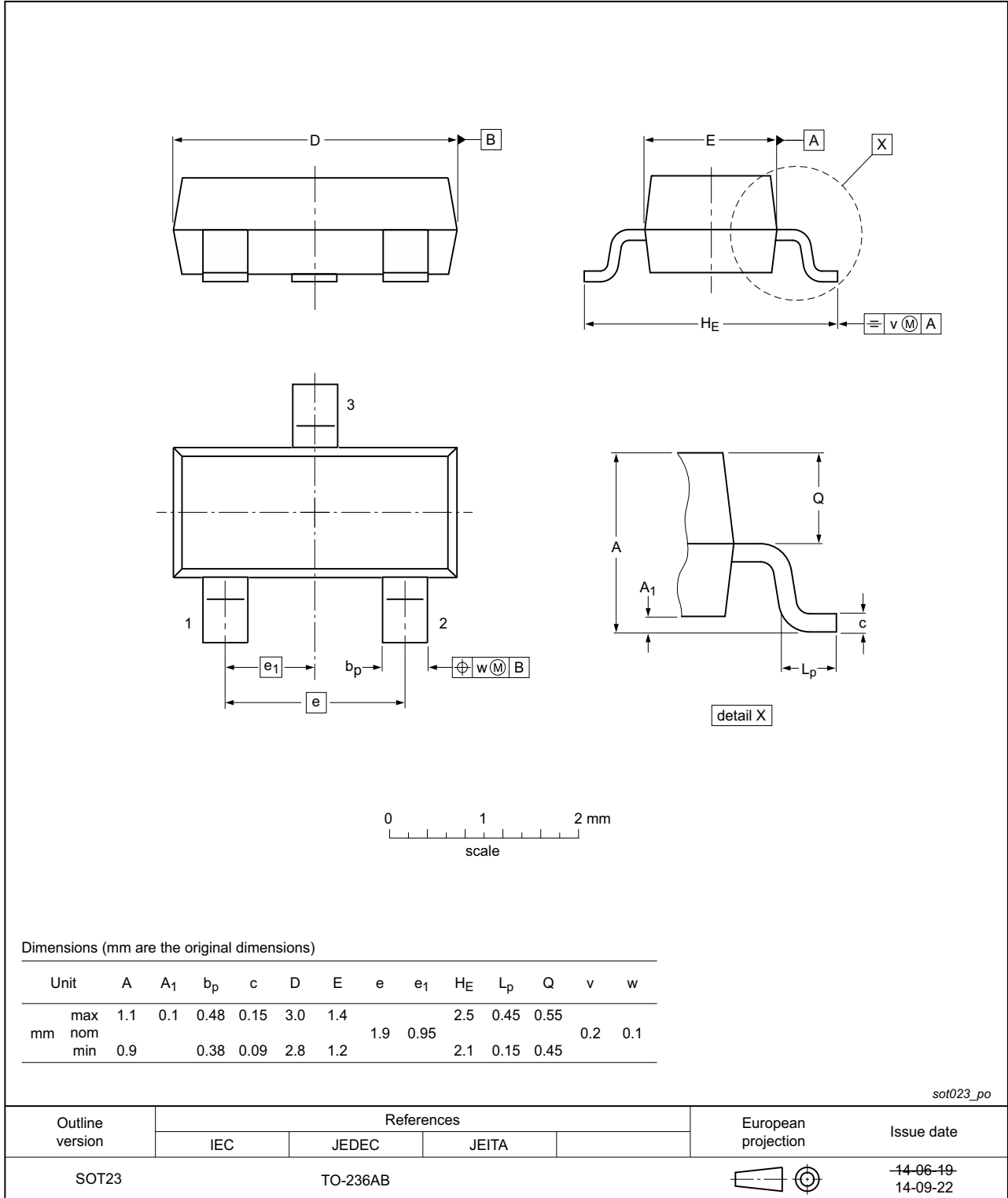

**Fig 5. Package outline SOT23**

## 9. Abbreviations

Table 7. Abbreviations

Acronym	Description
AQL	Acceptable Quality Level
PIN	P-type, Intrinsic, N-type
SMD	Surface Mounted Device
S4	Special inspection level 4

## 10. Revision history

Table 8. Revision history

Document ID	Release date	Data sheet status	Change notice	Supersedes
BAP64-06 v.4	20150428	Product data sheet	-	BAP64-06 v.3.1
Modifications:	<ul style="list-style-type: none"> <li>The format of this data sheet has been redesigned to comply with the new identity guidelines of NXP Semiconductors.</li> <li>Legal texts have been adapted to the new company name where appropriate.</li> <li>AEC-Q101 qualified</li> </ul>			
BAP64-06_v.3 (9397 750 06664)	20010217	Product specification	-	BAP64-06 v.2
BAP64-06 v.2 (9397 750 06911)	20000322	Product specification	-	BAP64-06_N v.1
BAP64-06_N v.1 (9397 750 08033)	19991217	Preliminary specification	-	-

## 11. Legal information

### 11.1 Data sheet status

Document status <sup>[1][2]</sup>	Product status <sup>[3]</sup>	Definition
Objective [short] data sheet	Development	This document contains data from the objective specification for product development.
Preliminary [short] data sheet	Qualification	This document contains data from the preliminary specification.
Product [short] data sheet	Production	This document contains the product specification.

[1] Please consult the most recently issued document before initiating or completing a design.

[2] The term 'short data sheet' is explained in section "Definitions".

[3] The product status of device(s) described in this document may have changed since this document was published and may differ in case of multiple devices. The latest product status information is available on the Internet at URL <http://www.nxp.com>.

### 11.2 Definitions

**Draft** — The document is a draft version only. The content is still under internal review and subject to formal approval, which may result in modifications or additions. NXP Semiconductors does not give any representations or warranties as to the accuracy or completeness of information included herein and shall have no liability for the consequences of use of such information.

**Short data sheet** — A short data sheet is an extract from a full data sheet with the same product type number(s) and title. A short data sheet is intended for quick reference only and should not be relied upon to contain detailed and full information. For detailed and full information see the relevant full data sheet, which is available on request via the local NXP Semiconductors sales office. In case of any inconsistency or conflict with the short data sheet, the full data sheet shall prevail.

**Product specification** — The information and data provided in a Product data sheet shall define the specification of the product as agreed between NXP Semiconductors and its customer, unless NXP Semiconductors and customer have explicitly agreed otherwise in writing. In no event however, shall an agreement be valid in which the NXP Semiconductors product is deemed to offer functions and qualities beyond those described in the Product data sheet.

### 11.3 Disclaimers

**Limited warranty and liability** — Information in this document is believed to be accurate and reliable. However, NXP Semiconductors does not give any representations or warranties, expressed or implied, as to the accuracy or completeness of such information and shall have no liability for the consequences of use of such information. NXP Semiconductors takes no responsibility for the content in this document if provided by an information source outside of NXP Semiconductors.

In no event shall NXP Semiconductors be liable for any indirect, incidental, punitive, special or consequential damages (including - without limitation - lost profits, lost savings, business interruption, costs related to the removal or replacement of any products or rework charges) whether or not such damages are based on tort (including negligence), warranty, breach of contract or any other legal theory.

Notwithstanding any damages that customer might incur for any reason whatsoever, NXP Semiconductors' aggregate and cumulative liability towards customer for the products described herein shall be limited in accordance with the *Terms and conditions of commercial sale* of NXP Semiconductors.

**Right to make changes** — NXP Semiconductors reserves the right to make changes to information published in this document, including without limitation specifications and product descriptions, at any time and without notice. This document supersedes and replaces all information supplied prior to the publication hereof.

**Suitability for use in automotive applications** — This NXP Semiconductors product has been qualified for use in automotive applications. Unless otherwise agreed in writing, the product is not designed, authorized or warranted to be suitable for use in life support, life-critical or safety-critical systems or equipment, nor in applications where failure or malfunction of an NXP Semiconductors product can reasonably be expected to result in personal injury, death or severe property or environmental damage. NXP Semiconductors and its suppliers accept no liability for inclusion and/or use of NXP Semiconductors products in such equipment or applications and therefore such inclusion and/or use is at the customer's own risk.

**Applications** — Applications that are described herein for any of these products are for illustrative purposes only. NXP Semiconductors makes no representation or warranty that such applications will be suitable for the specified use without further testing or modification.

Customers are responsible for the design and operation of their applications and products using NXP Semiconductors products, and NXP Semiconductors accepts no liability for any assistance with applications or customer product design. It is customer's sole responsibility to determine whether the NXP Semiconductors product is suitable and fit for the customer's applications and products planned, as well as for the planned application and use of customer's third party customer(s). Customers should provide appropriate design and operating safeguards to minimize the risks associated with their applications and products.

NXP Semiconductors does not accept any liability related to any default, damage, costs or problem which is based on any weakness or default in the customer's applications or products, or the application or use by customer's third party customer(s). Customer is responsible for doing all necessary testing for the customer's applications and products using NXP Semiconductors products in order to avoid a default of the applications and the products or of the application or use by customer's third party customer(s). NXP does not accept any liability in this respect.

**Limiting values** — Stress above one or more limiting values (as defined in the Absolute Maximum Ratings System of IEC 60134) will cause permanent damage to the device. Limiting values are stress ratings only and (proper) operation of the device at these or any other conditions above those given in the Recommended operating conditions section (if present) or the Characteristics sections of this document is not warranted. Constant or repeated exposure to limiting values will permanently and irreversibly affect the quality and reliability of the device.

**Terms and conditions of commercial sale** — NXP Semiconductors products are sold subject to the general terms and conditions of commercial sale, as published at <http://www.nxp.com/profile/terms>, unless otherwise agreed in a valid written individual agreement. In case an individual agreement is concluded only the terms and conditions of the respective agreement shall apply. NXP Semiconductors hereby expressly objects to applying the customer's general terms and conditions with regard to the purchase of NXP Semiconductors products by customer.

**No offer to sell or license** — Nothing in this document may be interpreted or construed as an offer to sell products that is open for acceptance or the grant, conveyance or implication of any license under any copyrights, patents or other industrial or intellectual property rights.

**Export control** — This document as well as the item(s) described herein may be subject to export control regulations. Export might require a prior authorization from competent authorities.

**Translations** — A non-English (translated) version of a document is for reference only. The English version shall prevail in case of any discrepancy between the translated and English versions.

## 11.4 Trademarks

Notice: All referenced brands, product names, service names and trademarks are the property of their respective owners.

## 12. Contact information

---

For more information, please visit: <http://www.nxp.com>

For sales office addresses, please send an email to: [salesaddresses@nxp.com](mailto:salesaddresses@nxp.com)



## 13. Contents

<b>1</b>	<b>Product profile</b> . . . . .	<b>1</b>
1.1	General description . . . . .	1
1.2	Features and benefits . . . . .	1
1.3	Applications . . . . .	1
<b>2</b>	<b>Pinning information</b> . . . . .	<b>1</b>
<b>3</b>	<b>Ordering information</b> . . . . .	<b>1</b>
<b>4</b>	<b>Marking</b> . . . . .	<b>2</b>
<b>5</b>	<b>Limiting values</b> . . . . .	<b>2</b>
<b>6</b>	<b>Thermal characteristics</b> . . . . .	<b>2</b>
<b>7</b>	<b>Characteristics</b> . . . . .	<b>2</b>
7.1	Graphical data . . . . .	3
<b>8</b>	<b>Package outline</b> . . . . .	<b>5</b>
<b>9</b>	<b>Abbreviations</b> . . . . .	<b>6</b>
<b>10</b>	<b>Revision history</b> . . . . .	<b>6</b>
<b>11</b>	<b>Legal information</b> . . . . .	<b>7</b>
11.1	Data sheet status . . . . .	7
11.2	Definitions . . . . .	7
11.3	Disclaimers . . . . .	7
11.4	Trademarks . . . . .	8
<b>12</b>	<b>Contact information</b> . . . . .	<b>8</b>
<b>13</b>	<b>Contents</b> . . . . .	<b>9</b>

Please be aware that important notices concerning this document and the product(s) described herein, have been included in section 'Legal information'.

© NXP Semiconductors N.V. 2015.

All rights reserved.

For more information, please visit: <http://www.nxp.com>

For sales office addresses, please send an email to: [salesaddresses@nxp.com](mailto:salesaddresses@nxp.com)

Date of release: 28 April 2015

Document identifier: BAP64-06