

MBR3045PT

Preferred Device

SWITCHMODE™ Power Rectifier

These state-of-the-art devices use the Schottky Barrier principle with a platinum barrier metal.

Features

- Dual Diode Construction; Terminals 1 and 3 may be Connected for Parallel Operation at Full Rating
- Guard-ring for Stress Protection
- Low Forward Voltage
- 175°C Operating Junction Temperature
- Pb-Free Package is Available*

Mechanical Characteristics

- Case: Epoxy, Molded
- Weight: 4.3 Grams (Approximately)
- Finish: All External Surfaces Corrosion Resistant and Terminal Leads are Readily Solderable
- Lead Temperature for Soldering Purposes: 260°C Max. for 10 Seconds

MAXIMUM RATINGS

Rating	Symbol	Max	Unit
Peak Repetitive Reverse Voltage Working Peak Reverse Voltage DC Blocking Voltage	V_{RRM} V_{RWM} V_R	45	V
Average Rectified Forward Current (Rated V_R , $T_C = 105^\circ\text{C}$) Per Device Per Diode	$I_{F(AV)}$	30 15	A
Peak Repetitive Forward Current, (Rated V_R , Square Wave, 20 kHz) Per Diode	I_{FRM}	30	A
Non-Repetitive Peak Surge Current (Surge Applied at Rated Load Conditions Halfwave, Single Phase, 60 Hz)	I_{FSM}	200	A
Peak Repetitive Reverse Current (2.0 μs , 1.0 kHz) Per Diode (See Figure 6)	I_{RRM}	2.0	A
Storage Temperature Range	T_{stg}	-65 to +175	°C
Operating Junction Temperature (Note 1)	T_J	-65 to +175	°C
Peak Surge Junction Temperature (Forward Current Applied)	$T_{J(pk)}$	175	°C
Voltage Rate of Change (Rated V_R)	dv/dt	10,000	V/ μs

Maximum ratings are those values beyond which device damage can occur. Maximum ratings applied to the device are individual stress limit values (not normal operating conditions) and are not valid simultaneously. If these limits are exceeded, device functional operation is not implied, damage may occur and reliability may be affected.

1. The heat generated must be less than the thermal conductivity from Junction-to-Ambient: $dP_D/dT_J < 1/R_{\theta JA}$.

*For additional information on our Pb-Free strategy and soldering details, please download the ON Semiconductor Soldering and Mounting Techniques Reference Manual, SOLDERRM/D.



ON Semiconductor®

<http://onsemi.com>

SCHOTTKY BARRIER RECTIFIER 30 AMPERES, 45 VOLTS

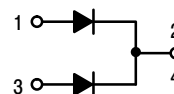

MARKING DIAGRAM

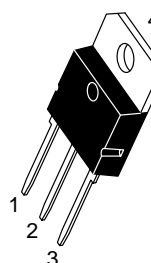

SOT-93
CASE 340D
PLASTIC

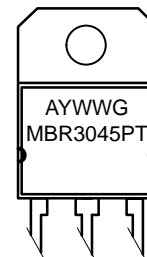

A = Assembly Location
Y = Year
WW = Work Week
G = Pb-Free Package

ORDERING INFORMATION

Device	Package	Shipping
MBR3045PT	SOT-93	30 Units / Rail
MBR3045PTG	SOT-93 (Pb-Free)	30 Units / Rail

Preferred devices are recommended choices for future use and best overall value.

MBR3045PT

THERMAL CHARACTERISTICS (Per Diode)

Rating	Symbol	Max	Unit
Thermal Resistance, Junction-to-Case	$R_{\theta JC}$	1.4	$^{\circ}C/W$
Thermal Resistance, Junction-to-Ambient	$R_{\theta JA}$	40	$^{\circ}C/W$

ELECTRICAL CHARACTERISTICS (Per Diode)

Instantaneous Forward Voltage (Note 2) ($i_F = 20$ Amps, $T_C = 125^{\circ}C$) ($i_F = 30$ Amps, $T_C = 125^{\circ}C$) ($i_F = 30$ Amps, $T_C = 25^{\circ}C$)	V_F	0.60 0.72 0.76	V
Instantaneous Reverse Current (Note 2) (Rated dc Voltage, $T_C = 125^{\circ}C$) (Rated dc Voltage, $T_C = 25^{\circ}C$)	i_R	100 1.0	mA

2. Pulse Test: Pulse Width = 300 μs , Duty Cycle $\leq 2.0\%$.

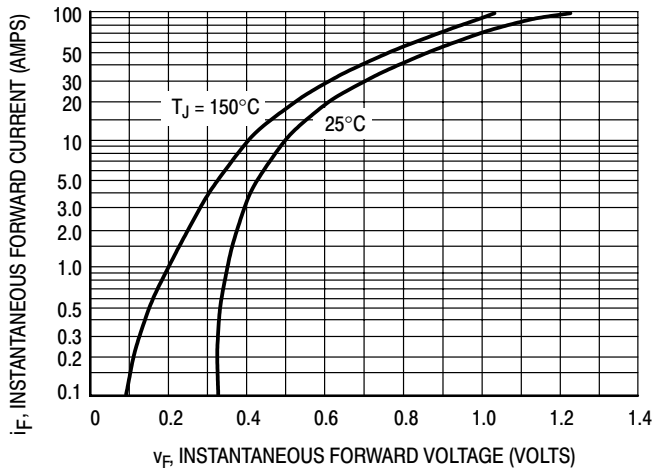

Figure 1. Typical Forward Voltage

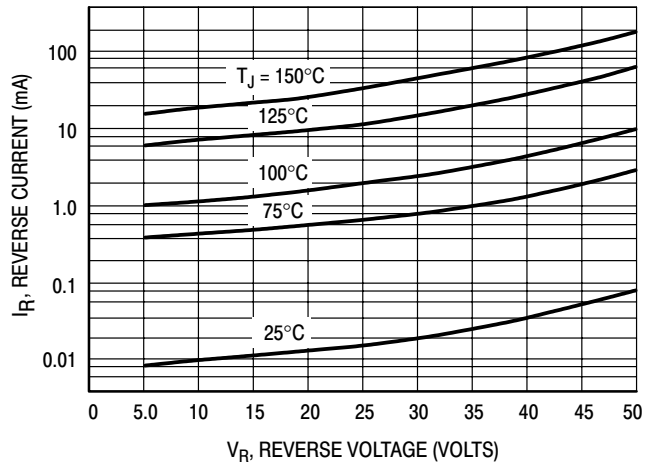

Figure 2. Typical Reverse Current

MBR3045PT

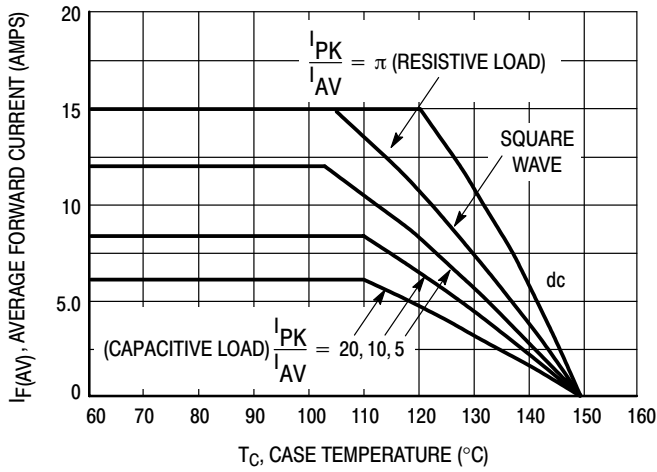

Figure 3. Current Derating (Per Leg)

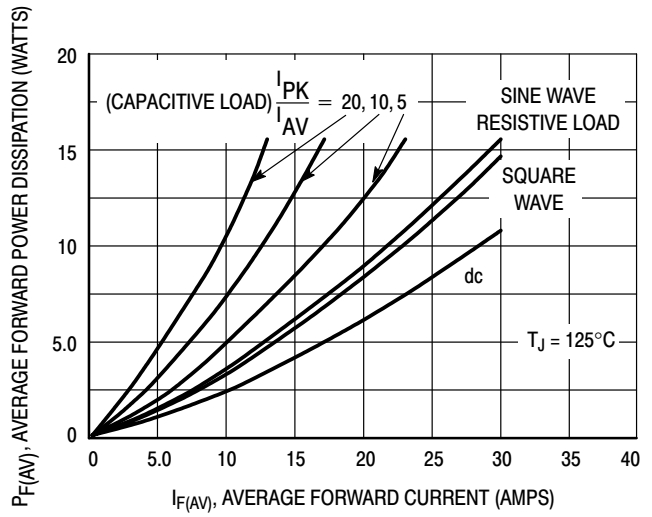

Figure 4. Forward Power Dissipation (Per Leg)

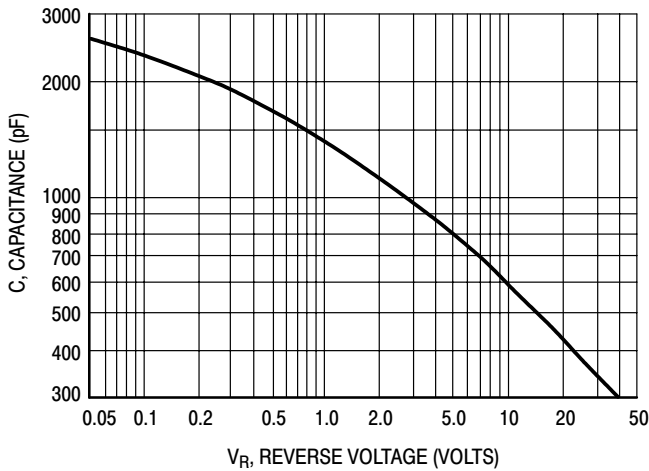

Figure 5. Capacitance

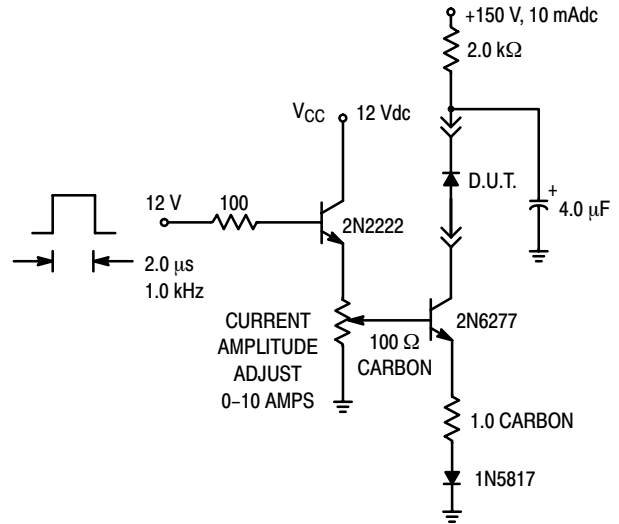
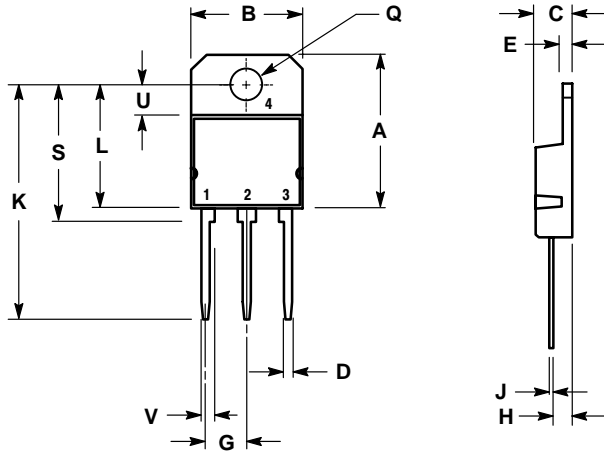

Figure 6. Test Circuit for Repetitive Reverse Current

MBR3045PT

PACKAGE DIMENSIONS

SOT-93 (TO-218)
PLASTIC
CASE 340D-02
ISSUE E



- NOTES:
1. DIMENSIONING AND TOLERANCING PER ANSI Y14.5M, 1982.
2. CONTROLLING DIMENSION: MILLIMETER.

DIM	MILLIMETERS		INCHES	
	MIN	MAX	MIN	MAX
A	---	20.35	---	0.801
B	14.70	15.20	0.579	0.598
C	4.70	4.90	0.185	0.193
D	1.10	1.30	0.043	0.051
E	1.17	1.37	0.046	0.054
G	5.40	5.55	0.213	0.219
H	2.00	3.00	0.079	0.118
J	0.50	0.78	0.020	0.031
K	31.00 REF		1.220 REF	
L	---	16.20	---	0.638
Q	4.00	4.10	0.158	0.161
S	17.80	18.20	0.701	0.717
U	4.00 REF		0.157 REF	
V	1.75 REF		0.069	

- STYLE 1:
PIN 1. BASE
2. COLLECTOR
3. EMITTER
4. COLLECTOR

SWITCHMODE is a trademark of Semiconductor Components Industries, LLC.

ON Semiconductor and  are registered trademarks of Semiconductor Components Industries, LLC (SCILLC). SCILLC reserves the right to make changes without further notice to any products herein. SCILLC makes no warranty, representation or guarantee regarding the suitability of its products for any particular purpose, nor does SCILLC assume any liability arising out of the application or use of any product or circuit, and specifically disclaims any and all liability, including without limitation special, consequential or incidental damages. "Typical" parameters which may be provided in SCILLC data sheets and/or specifications can and do vary in different applications and actual performance may vary over time. All operating parameters, including "Typicals" must be validated for each customer application by customer's technical experts. SCILLC does not convey any license under its patent rights nor the rights of others. SCILLC products are not designed, intended, or authorized for use as components in systems intended for surgical implant into the body, or other applications intended to support or sustain life, or for any other application in which the failure of the SCILLC product could create a situation where personal injury or death may occur. Should Buyer purchase or use SCILLC products for any such unintended or unauthorized application, Buyer shall indemnify and hold SCILLC and its officers, employees, subsidiaries, affiliates, and distributors harmless against all claims, costs, damages, and expenses, and reasonable attorney fees arising out of, directly or indirectly, any claim of personal injury or death associated with such unintended or unauthorized use, even if such claim alleges that SCILLC was negligent regarding the design or manufacture of the part. SCILLC is an Equal Opportunity/Affirmative Action Employer. This literature is subject to all applicable copyright laws and is not for resale in any manner.

PUBLICATION ORDERING INFORMATION

LITERATURE FULFILLMENT:
Literature Distribution Center for ON Semiconductor
P.O. Box 61312, Phoenix, Arizona 85082-1312 USA
Phone: 480-829-7710 or 800-344-3860 Toll Free USA/Canada
Fax: 480-829-7709 or 800-344-3867 Toll Free USA/Canada
Email: orderlit@onsemi.com

N. American Technical Support: 800-282-9855 Toll Free USA/Canada

Japan: ON Semiconductor, Japan Customer Focus Center
2-9-1 Kamimeguro, Meguro-ku, Tokyo, Japan 153-0051
Phone: 81-3-5773-3850

ON Semiconductor Website: <http://onsemi.com>

Order Literature: <http://www.onsemi.com/litorder>

For additional information, please contact your local Sales Representative.

MBR3045PT/D