

THESE DRAWINGS ARE THE PROPERTY OF QUALTEK ELECTRONICS AND NOT TO BE REPRODUCED FOR OR COMMUNICATED TO A THIRD PARTY WITHOUT THE EXPRESS WRITTEN PERMISSION OF AN OFFICER OF QUALTEK ELECTRONICS.

REVISION			
REV.	DESCRIPTION	DATE	APPROVED
B	Added Dimensions	09-09-08	LY

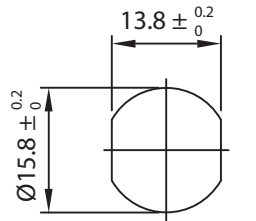

PANEL CUTOUT

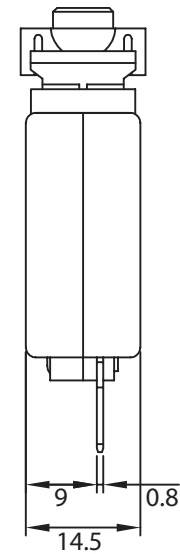
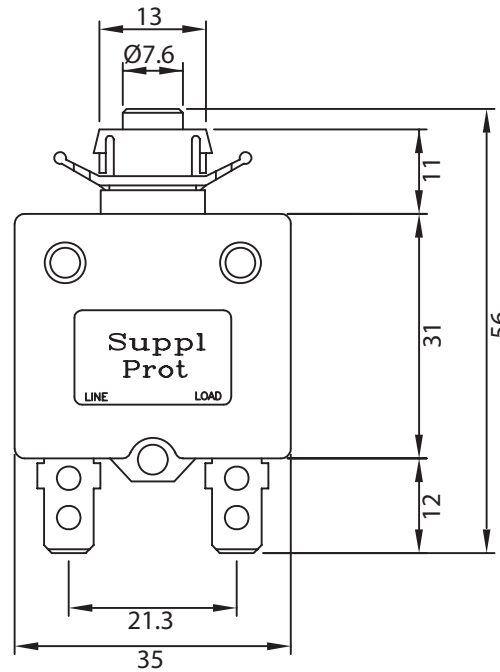
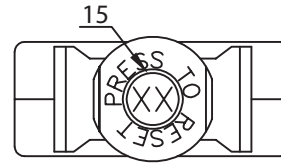
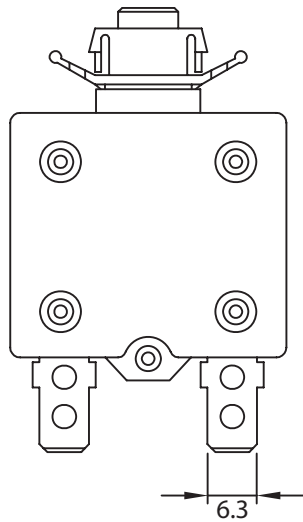

NOTES:

RATING: 15A 125-250V AC/32V DC
 PANEL THICKNESS: 0.8mm~2.5mm
 APPROVALS: UL, cUL, TUV, CCC, CE
 RoHS COMPLIANT

CONTROLLED

Dim range (mm)	Tolerance +/- (mm)	Qualtek Electronics Corp. PPC DIVISION		
		Part Number: QLB-153-00DNN-3BA		RoHS Compliant
0-1	0.15	Description: CIRCUIT BREAKER		
1-6	0.20	UNIT: mm		
6-18	0.30			
18-50	0.50	REV. B		
50-120	0.70	Drawn / Date	Checked / Date	Approved / Date
120-250	0.90	R.Nuti 06-03-08	06-03-08	LY / 06-03-08
250-500	1.20			