

# FEMTOCLOCKS™ CRYSTAL-TO- LVDS CLOCK GENERATOR

**ICS844051I**

## GENERAL DESCRIPTION



The ICS844051I is a Gigabit Ethernet Clock Generator and a member of the HiPerClocks™ family of high performance devices from ICS. The ICS844051I can synthesize 10 Gigabit Ethernet, SONET, or Serial ATA reference clock frequencies with the appropriate choice of crystal and output divider. The ICS844051I has excellent phase jitter performance and is packaged in a small 8-pin TSSOP, making it ideal for use in systems with limited board space.

## FEATURES

- One Differential LVDS output
- Crystal oscillator interface designed for 18pF parallel resonant crystals (18.125MHz - 23.4375MHz)
- Output frequency range: 145MHz - 187.5MHz and 72.5MHz - 93.75MHz
- VCO range: 580MHz - 750MHz
- RMS phase jitter @ 156.25MHz (1.875MHz - 20MHz): 0.45ps (typical)
- 3.3V or 2.5V operating supply
- -40°C to 85°C ambient operating temperature
- Available in both standard and lead-free RoHS-compliant packages

**FREQUENCY TABLE**

Inputs		Output Frequency (MHz)
Crystal Frequency (MHz)	FREQ_SEL	
20.141601	0	161.132812
20.141601	1	80.566406
19.53125	0	156.25
19.53125	1	78.125
19.44	0	155.52
19.44	1	77.76
18.75	0	150
18.75	1	75

## BLOCK DIAGRAM

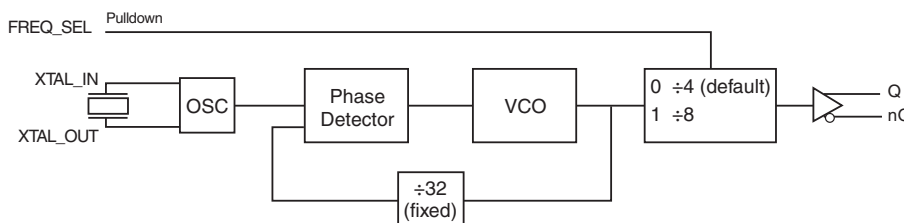

## PIN ASSIGNMENT

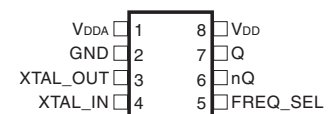
**ICS844051I**
**8-Lead TSSOP**

4.40mm x 3.0mm x 0.925mm

package body

**G Package**

Top View

The Preliminary Information presented herein represents a product in prototyping or pre-production. The noted characteristics are based on initial product characterization. Integrated Circuit Systems, Incorporated (ICS) reserves the right to change any circuitry or specifications without notice.

TABLE 1. PIN DESCRIPTIONS

Number	Name	Type		Description
1	V <sub>DDA</sub>	Power		Analog supply pin.
2	GND	Power		Power supply ground.
3, 4	XTAL_OUT, XTAL_IN	Input		Crystal oscillator interface. XTAL_IN is the input, XTAL_OUT is the output.
5	FREQ_SEL	Input	Pullup	Frequency select pin.
6, 7	nQ, Q	Output		Differential clock outputs. LVDS interface levels.
8	V <sub>DD</sub>	Power		Power supply pin.

NOTE: *Pullup* refers to internal input resistors. See Table 2, Pin Characteristics, for typical values.

TABLE 2. PIN CHARACTERISTICS

Symbol	Parameter	Test Conditions	Minimum	Typical	Maximum	Units
C <sub>IN</sub>	Input Capacitance			4		pF
R <sub>PULLUP</sub>	Input Pullup Resistor			51		kΩ

## ABSOLUTE MAXIMUM RATINGS

Supply Voltage, $V_{DD}$	4.6V
Inputs, $V_I$	-0.5V to $V_{DD} + 0.5$ V
Outputs, $I_O$ (LVDS)	
Continuous Current	10mA
Surge Current	15mA
Package Thermal Impedance, $\theta_{JA}$	101.7°C/W (0 mps)
Storage Temperature, $T_{STG}$	-65°C to 150°C

NOTE: Stresses beyond those listed under Absolute Maximum Ratings may cause permanent damage to the device. These ratings are stress specifications only. Functional operation of product at these conditions or any conditions beyond those listed in the *DC Characteristics* or *AC Characteristics* is not implied. Exposure to absolute maximum rating conditions for extended periods may affect product reliability.

TABLE 3A. POWER SUPPLY DC CHARACTERISTICS,  $V_{DD} = V_{DDA} = 3.3V \pm 5\%$ ,  $T_A = -40^\circ\text{C}$  TO  $85^\circ\text{C}$ 

Symbol	Parameter	Test Conditions	Minimum	Typical	Maximum	Units
$V_{DD}$	Power Supply Voltage		3.135	3.3	3.465	V
$V_{DDA}$	Analog Supply Voltage		3.135	3.3	3.465	V
$I_{DD}$	Power Supply Current			100		mA
$I_{DDA}$	Analog Supply Current			8		mA

TABLE 3B. POWER SUPPLY DC CHARACTERISTICS,  $V_{DD} = V_{DDA} = 2.5V \pm 5\%$ ,  $T_A = -40^\circ\text{C}$  TO  $85^\circ\text{C}$ 

Symbol	Parameter	Test Conditions	Minimum	Typical	Maximum	Units
$V_{DD}$	Power Supply Voltage		2.375	2.5	2.625	V
$V_{DDA}$	Analog Supply Voltage		2.375	2.5	2.625	V
$I_{DD}$	Power Supply Current			95		mA
$I_{DDA}$	Analog Supply Current			8		mA

TABLE 3C. LVCMOS/LVTTL DC CHARACTERISTICS,  $V_{DD} = V_{DDA} = 3.3V \pm 5\%$  OR  $2.5V \pm 5\%$ ,  $T_A = -40^\circ\text{C}$  TO  $85^\circ\text{C}$ 

Symbol	Parameter	Test Conditions	Minimum	Typical	Maximum	Units
$V_{IH}$	Input High Voltage	$V_{DD} = 3.3V$	2		$V_{DD} + 0.3$	V
		$V_{DD} = 2.5$	1.7		$V_{DD} + 0.3$	V
$V_{IL}$	Input Low Voltage	$V_{DD} = 3.3V$	-0.3		0.8	V
		$V_{DD} = 2.5$	-0.3		0.7	V
$I_{IH}$	Input High Current	$V_{DD} = V_{IN} = 3.465V$ or $2.625V$			5	$\mu\text{A}$
$I_{IL}$	Input Low Current	$V_{DD} = 3.465V$ or $2.625V$ , $V_{IN} = 0V$	-150			$\mu\text{A}$

TABLE 3D. LVDS DC CHARACTERISTICS,  $V_{DD} = V_{DDA} = 3.3V \pm 5\%$ ,  $T_A = -40^\circ\text{C}$  TO  $85^\circ\text{C}$ 

Symbol	Parameter	Test Conditions	Minimum	Typical	Maximum	Units
$V_{OD}$	Differential Output Voltage			350		mV
$\Delta V_{OD}$	$V_{OD}$ Magnitude Change			400		mV
$V_{OS}$	Offset Voltage			1.4		V
$\Delta V_{OS}$	$V_{OS}$ Magnitude Change			50		mV

TABLE 3E. LVDS DC CHARACTERISTICS,  $V_{DD} = V_{DDA} = 2.5V \pm 5\%$ ,  $T_A = -40^\circ\text{C}$  TO  $85^\circ\text{C}$ 

Symbol	Parameter	Test Conditions	Minimum	Typical	Maximum	Units
$V_{OD}$	Differential Output Voltage			350		mV
$\Delta V_{OD}$	$V_{OD}$ Magnitude Change			400		mV
$V_{OS}$	Offset Voltage			1.15		V
$\Delta V_{OS}$	$V_{OS}$ Magnitude Change			40		mV

TABLE 4. CRYSTAL CHARACTERISTICS

Parameter	Test Conditions	Minimum	Typical	Maximum	Units
Mode of Oscillation		Fundamental			
Frequency		18.125		23.4375	MHz
Equivalent Series Resistance (ESR)				50	$\Omega$
Shunt Capacitance				7	pF
Drive Level				1	mW

TABLE 5A. AC CHARACTERISTICS,  $V_{DD} = V_{DDA} = 3.3V \pm 5\%$ ,  $T_A = -40^\circ\text{C}$  TO  $85^\circ\text{C}$ 

Symbol	Parameter	Test Conditions	Minimum	Typical	Maximum	Units
$f_{OUT}$	Output Frequency			156.25		MHz
$\tau_{jit}(\emptyset)$	RMS Phase Jitter ( Random); NOTE 1	156.25MHz @ Integration Range: 1.875MHz - 20MHz		0.45		ps
$t_R / t_F$	Output Rise/Fall Time	20% to 80%		300		ps
odc	Output Duty Cycle			50		%

NOTE 1: Please refer to the Phase Noise Plots following this section.

TABLE 5B. AC CHARACTERISTICS,  $V_{DD} = V_{DDA} = 2.5V \pm 5\%$ ,  $T_A = -40^\circ\text{C}$  TO  $85^\circ\text{C}$ 

Symbol	Parameter	Test Conditions	Minimum	Typical	Maximum	Units
$f_{OUT}$	Output Frequency			156.25		MHz
$\tau_{jit}(\emptyset)$	RMS Phase Jitter ( Random); NOTE 1	156.25MHz @ Integration Range: 1.875MHz - 20MHz		0.45		ps
$t_R / t_F$	Output Rise/Fall Time	20% to 80%		300		ps
odc	Output Duty Cycle			50		%

NOTE 1: Please refer to the Phase Noise Plots following this section.

**TYPICAL PHASE NOISE AT 156.25MHz @ 3.3V**

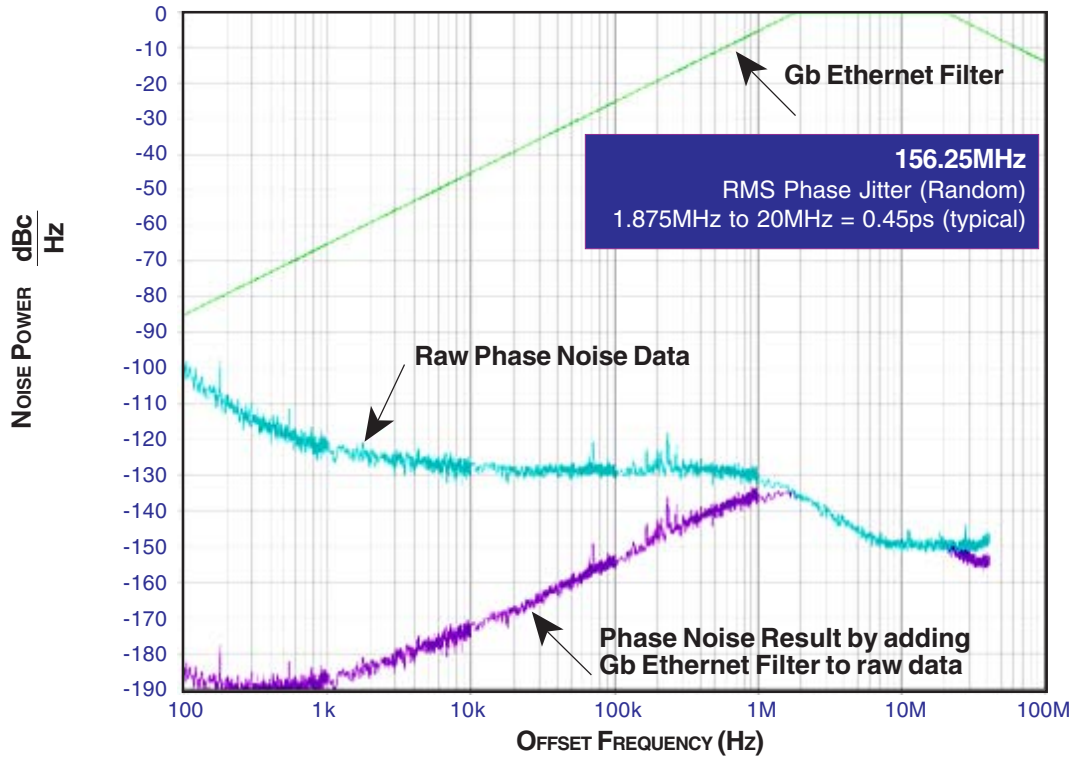

**TYPICAL PHASE NOISE AT 156.25MHz @ 2.5V**

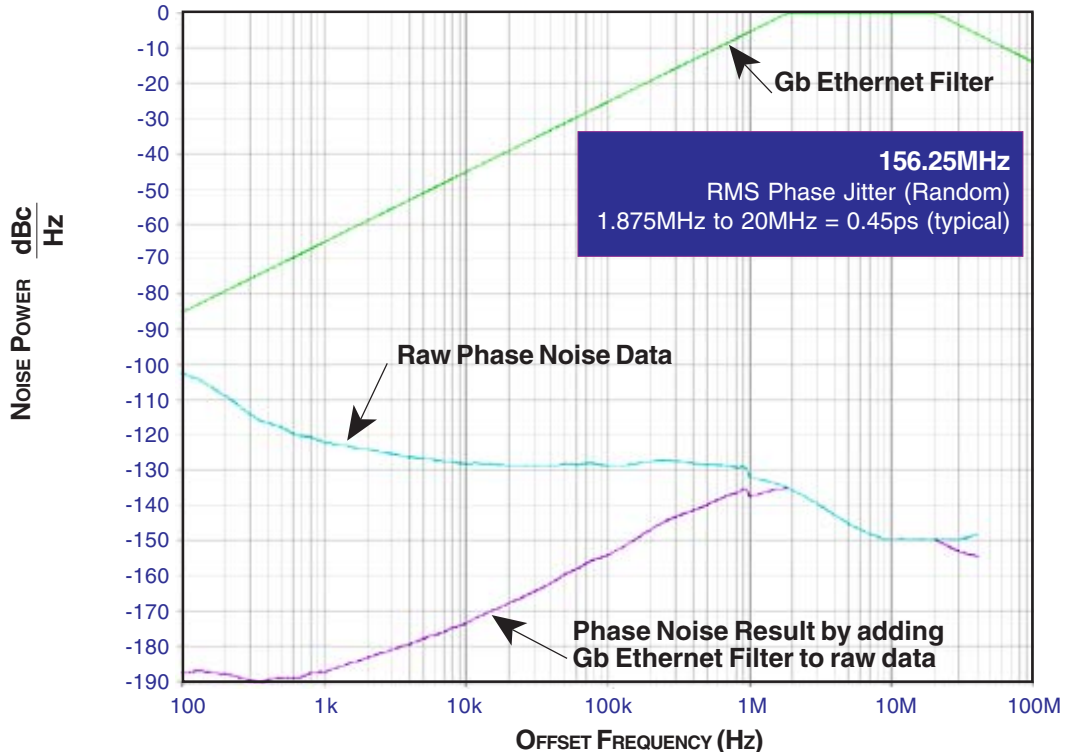

## PARAMETER MEASUREMENT INFORMATION

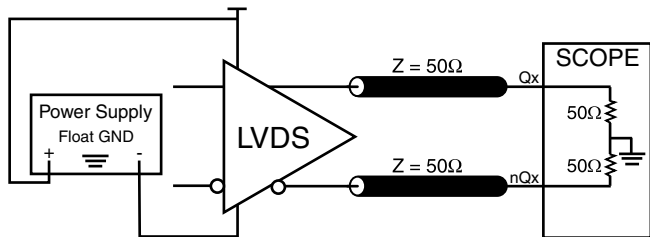

LVDS 3.3V OUTPUT LOAD AC TEST CIRCUIT

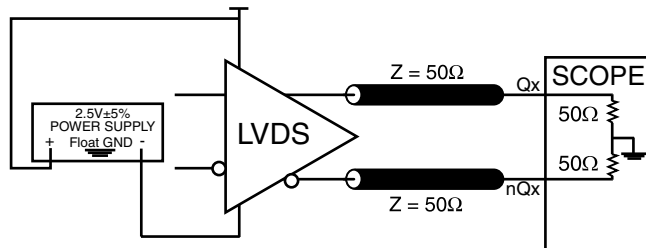

LVDS 2.5V OUTPUT LOAD AC TEST CIRCUIT

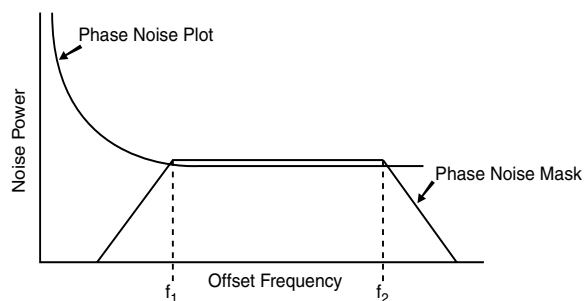

$$\text{RMS Jitter} = \sqrt{\text{Area Under the Masked Phase Noise Plot}}$$

RMS PHASE JITTER

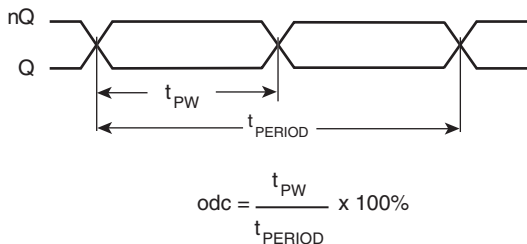

$$\text{odc} = \frac{t_{PW}}{t_{PERIOD}} \times 100\%$$

OUTPUT DUTY CYCLE/PULSE WIDTH/PERIOD

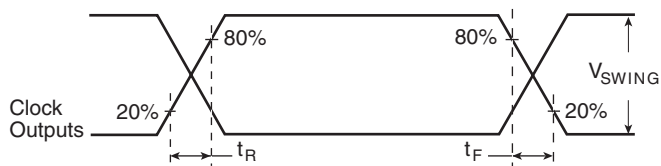

OUTPUT RISE/FALL TIME

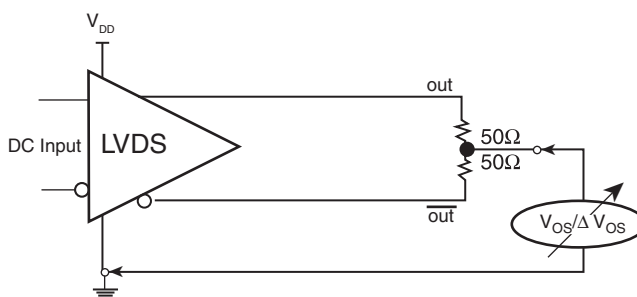

OFFSET VOLTAGE SETUP

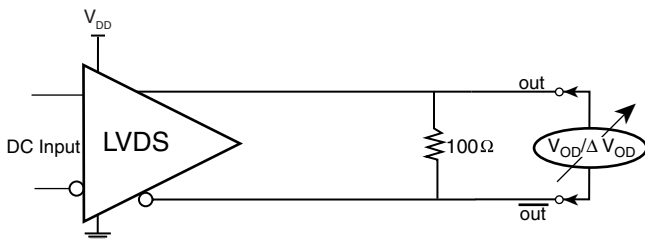

DIFFERENTIAL OUTPUT VOLTAGE SETUP

## APPLICATION INFORMATION

### POWER SUPPLY FILTERING TECHNIQUES

As in any high speed analog circuitry, the power supply pins are vulnerable to random noise. The ICS844051I provides separate power supplies to isolate any high switching noise from the outputs to the internal PLL.  $V_{DD}$  and  $V_{DDA}$  should be individually connected to the power supply plane through vias, and bypass capacitors should be used for each pin. To achieve optimum jitter performance, power supply isolation is required. *Figure 1* illustrates how a  $10\Omega$  resistor along with a  $10\mu\text{F}$  and a  $.01\mu\text{F}$  bypass capacitor should be connected to each  $V_{DDA}$  pin. The  $10\Omega$  resistor can also be replaced by a ferrite bead.

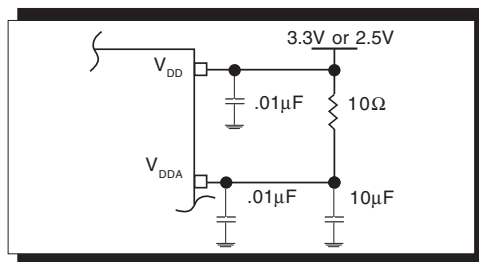

FIGURE 1. POWER SUPPLY FILTERING

### CRYSTAL INPUT INTERFACE

The ICS844051I has been characterized with 18pF parallel resonant crystals. The capacitor values, C1 and C2, shown in *Figure 2* below were determined using a 25MHz, 18pF parallel

resonant crystal and were chosen to minimize the ppm error. The optimum C1 and C2 values can be slightly adjusted for different board layouts.

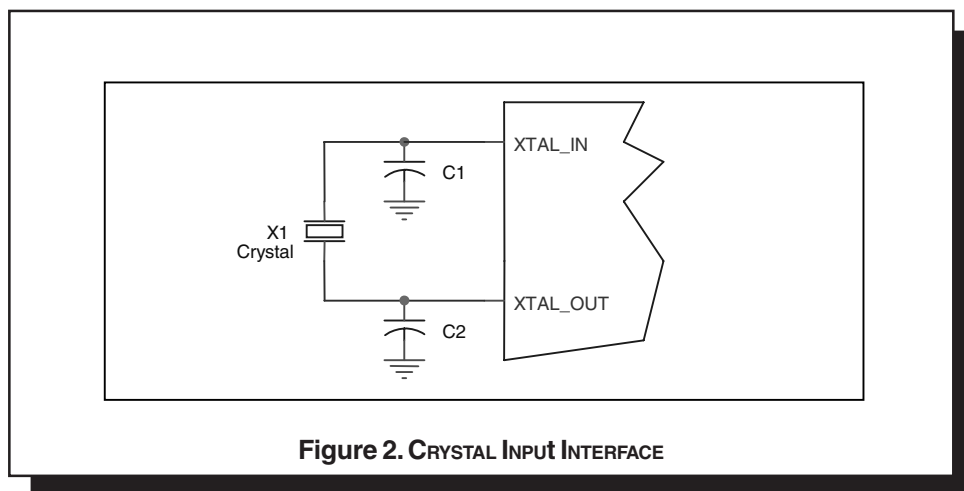

Figure 2. CRYSTAL INPUT INTERFACE

### 3.3V, 2.5V LVDS DRIVER TERMINATION

A general LVDS interface is shown in *Figure 3*. In a  $100\Omega$  differential transmission line environment, LVDS drivers require a matched load termination of  $100\Omega$  across near

the receiver input. For a multiple LVDS outputs buffer, if only partial outputs are used, it is recommended to terminate the un-used outputs.

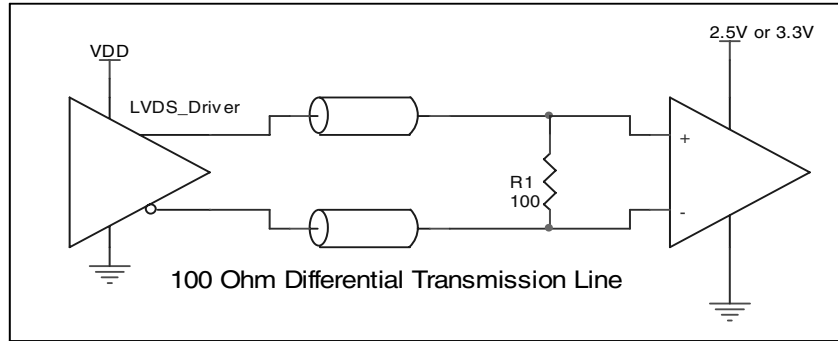

FIGURE 3. TYPICAL LVDS DRIVER TERMINATION



## RELIABILITY INFORMATION

TABLE 6.  $\theta_{JA}$  VS. AIR FLOW TABLE FOR 8 LEAD TSSOP

$\theta_{JA}$ by Velocity (Meters per Second)			
	0	1	2.5
Multi-Layer PCB, JEDEC Standard Test Boards	101.7°C/W	90.5°C/W	89.8°C/W

### TRANSISTOR COUNT

The transistor count for ICS844051I is: 2395

## PACKAGE OUTLINE - G SUFFIX FOR 8 LEAD TSSOP

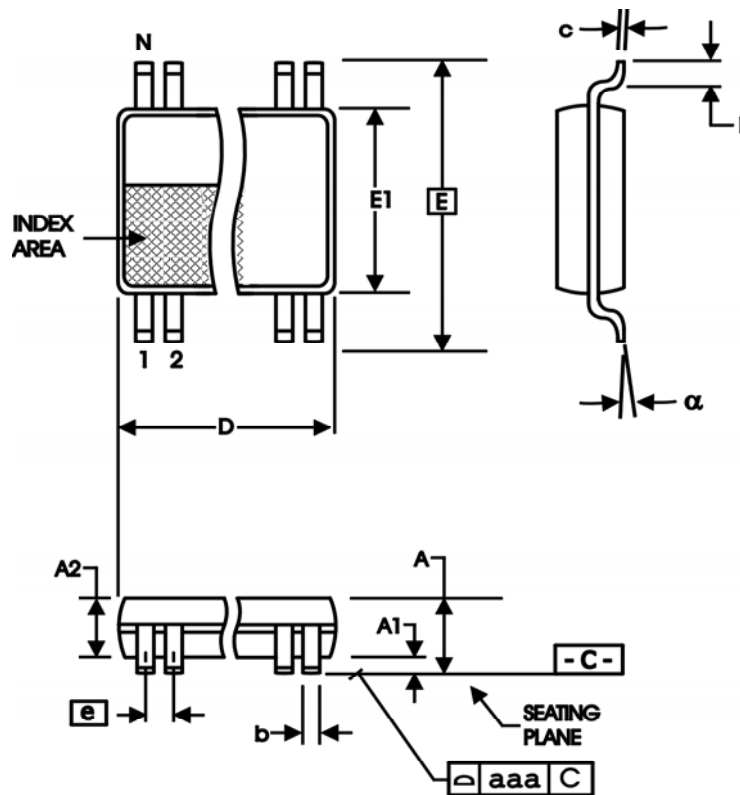

TABLE 7. PACKAGE DIMENSIONS

SYMBOL	Millimeters	
	Minimum	Maximum
N	8	
A	--	1.20
A1	0.05	0.15
A2	0.80	1.05
b	0.19	0.30
c	0.09	0.20
D	2.90	3.10
E	6.40 BASIC	
E1	4.30	4.50
e	0.65 BASIC	
L	0.45	0.75
$\alpha$	0°	8°
aaa	--	0.10

Reference Document: JEDEC Publication 95, MO-153

TABLE 8. ORDERING INFORMATION

Part/Order Number	Marking	Package	Shipping Packaging	Temperature
ICS844051CGI	451CI	8 Lead TSSOP	tube	-40°C to 85°C
ICS844051CGIT	451CI	8 Lead TSSOP	2500 tape & reel	-40°C to 85°C
ICS844051CGILF	TBD	8 Lead "Lead-Free" TSSOP	tube	-40°C to 85°C
ICS844051CGILFT	TBD	8 Lead "Lead-Free" TSSOP	2500 tape & reel	-40°C to 85°C

NOTE: Parts that are ordered with an "LF" suffix to the part number are the Pb-Free configuration and are RoHS compliant.

The aforementioned trademarks, HiPerClockS and FemtoClocks are trademarks of Integrated Circuit Systems, Inc. or its subsidiaries in the United States and/or other countries. While the information presented herein has been checked for both accuracy and reliability, Integrated Circuit Systems, Incorporated (ICS) assumes no responsibility for either its use or for infringement of any patents or other rights of third parties, which would result from its use. No other circuits, patents, or licenses are implied. This product is intended for use in normal commercial and industrial applications. Any other applications such as those requiring high reliability or other extraordinary environmental requirements are not recommended without additional processing by ICS. ICS reserves the right to change any circuitry or specifications without notice. ICS does not authorize or warrant any ICS product for use in life support devices or critical medical instruments.

Innovate with IDT and accelerate your future networks. Contact:

**www.IDT.com**

**For Sales**

800-345-7015  
408-284-8200  
Fax: 408-284-2775

**For Tech Support**

clockhelp@idt.com  
408-284-8200

---

**Corporate Headquarters**

Integrated Device Technology, Inc.  
6024 Silver Creek Valley Road  
San Jose, CA 95138  
United States  
800 345 7015  
+408 284 8200 (outside U.S.)

**Asia Pacific and Japan**

Integrated Device Technology  
Singapore (1997) Pte. Ltd.  
Reg. No. 199707558G  
435 Orchard Road  
#20-03 Wisma Atria  
Singapore 238877  
+65 6 887 5505

**Europe**

IDT Europe, Limited  
Prime House  
Barnett Wood Lane  
Leatherhead, Surrey  
United Kingdom KT22 7DE  
+44 1372 363 339