

## Low drop power Schottky rectifier

Datasheet - production data

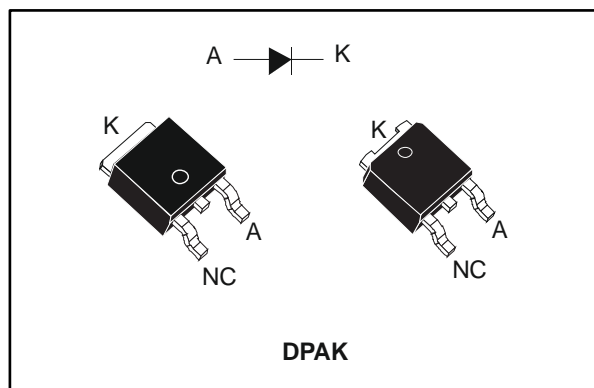

### Features

- Low cost device with low drop forward voltage for less power dissipation and reduced heatsink
- Optimized conduction/reverse losses trade-off which leads to the highest yield in the application
- High power surface mount miniature package
- Avalanche capability specified
- ECOPACK<sup>®</sup>2 compliant component for DPAK on demand

### Description

Single Schottky rectifier suited to switched mode power supplies and high frequency DC to DC converters.

Packaged in DPAK, this device is especially intended for use as a rectifier at the secondary of 3.3 V SMPS or DC/DC units, freewheeling and polarity protection applications.

**Table 1: Device summary**

Symbol	Value
$I_{F(AV)}$	8 A
$V_{RRM}$	30 V
$T_j$ (max.)	150 °C
$V_F$ (typ.)	0.35 V

# 1 Characteristics

**Table 2: Absolute ratings (limiting values at 25 °C, unless otherwise specified)**

Symbol	Parameter		Value	Unit
V <sub>RRM</sub>	Repetitive peak reverse voltage		30	V
I <sub>F(RMS)</sub>	Forward rms current		7	A
I <sub>F(AV)</sub>	Average forward current δ = 0.5, square wave	T <sub>C</sub> = 135 °C	8	A
I <sub>FSM</sub>	Surge non repetitive forward current	t <sub>p</sub> = 10 ms sinusoidal	75	A
P <sub>ARM</sub>	Repetitive peak avalanche power	t <sub>p</sub> = 10 μs, T <sub>j</sub> = 125 °C	215	W
T <sub>stg</sub>	Storage temperature range		-65 to +150	°C
T <sub>j</sub>	Maximum operating junction temperature <sup>(1)</sup>		150	°C

**Notes:**

<sup>(1)</sup>(dP<sub>tot</sub>/dT<sub>j</sub>) < (1/R<sub>th(j-a)</sub>) condition to avoid thermal runaway for a diode on its own heatsink.

**Table 3: Thermal parameters**

Symbol	Parameter	Max. value	Unit
R <sub>th(j-c)</sub>	Junction to case	2.5	°C/W

**Table 4: Static electrical characteristics**

Symbol	Parameter	Test conditions		Min.	Typ.	Max.	Unit
I <sub>R</sub> <sup>(1)</sup>	Reverse leakage current	T <sub>j</sub> = 25 °C	V <sub>R</sub> = V <sub>RRM</sub>	-		1	mA
		T <sub>j</sub> = 100 °C		-	15	40	
V <sub>F</sub> <sup>(1)</sup>	Forward voltage drop	T <sub>j</sub> = 25 °C	I <sub>F</sub> = 8 A	-		0.49	V
		T <sub>j</sub> = 125 °C		-	0.35	0.40	
		T <sub>j</sub> = 25 °C	I <sub>F</sub> = 16 A	-		0.63	
		T <sub>j</sub> = 125 °C		-	0.448	0.57	

**Notes:**

<sup>(1)</sup>Pulse test: t<sub>p</sub> = 380 μs, δ < 2%

To evaluate the conduction losses, use the following equation:

$$P = 0.23 \times I_{F(AV)} + 0.021 \times I_{F(RMS)}^2$$

### 1.1 Characteristics (curves)

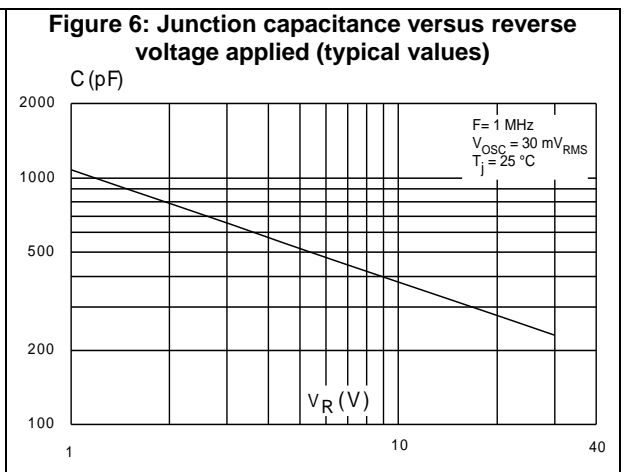
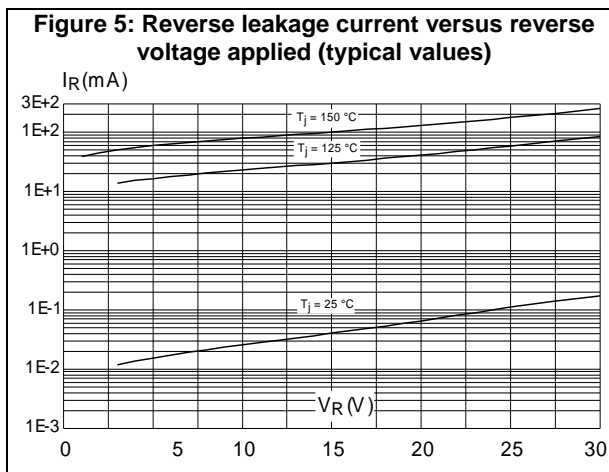
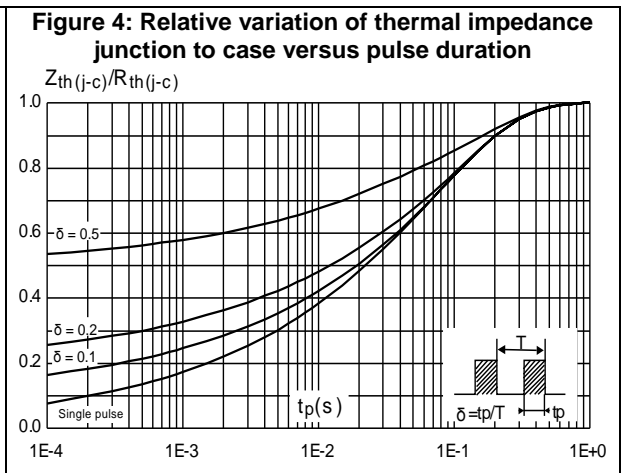
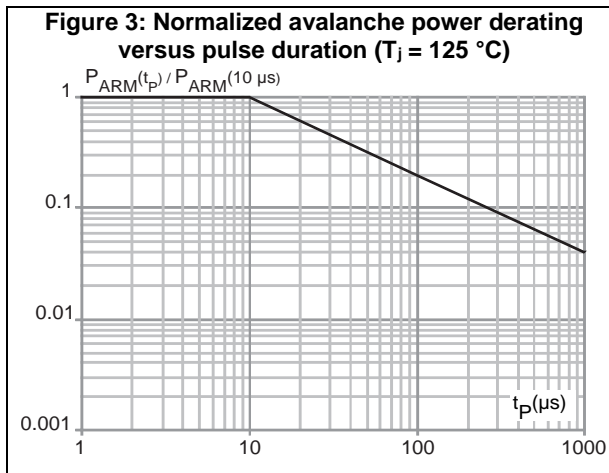
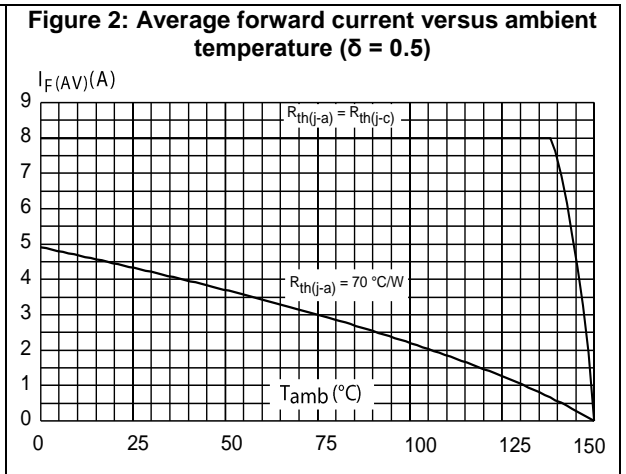
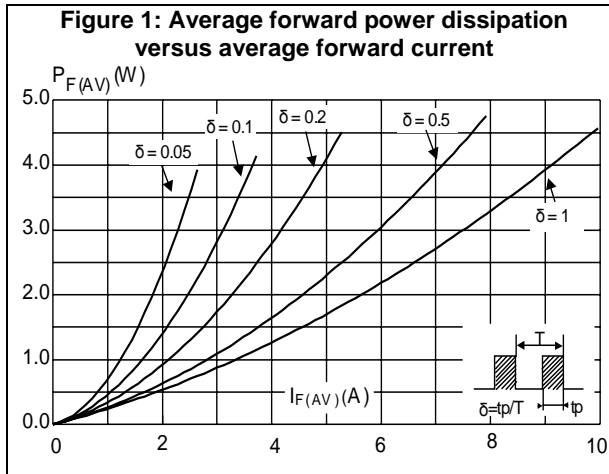

Figure 7: Forward voltage drop versus forward current

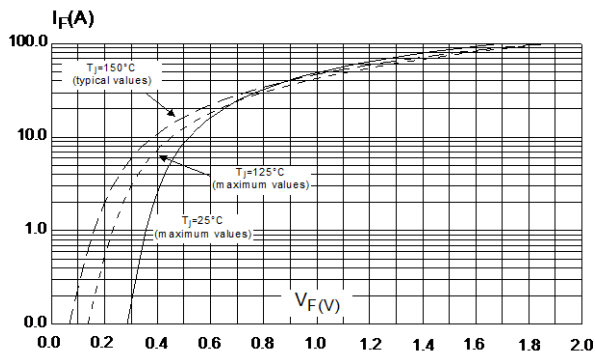
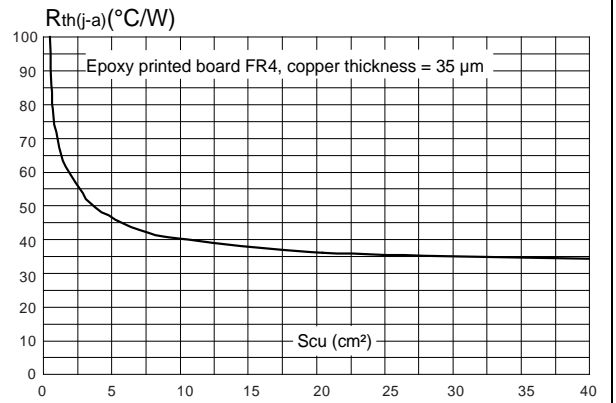

Figure 8: Thermal resistance junction to ambient versus copper surface under tab



## 2 Package information

In order to meet environmental requirements, ST offers these devices in different grades of ECOPACK® packages, depending on their level of environmental compliance. ECOPACK® specifications, grade definitions and product status are available at: [www.st.com](http://www.st.com). ECOPACK® is an ST trademark.

- Cooling method: by conduction (C)
- Epoxy meets UL 94,V0

## 2.1 DPAK package information

Figure 9: DPAK package outline

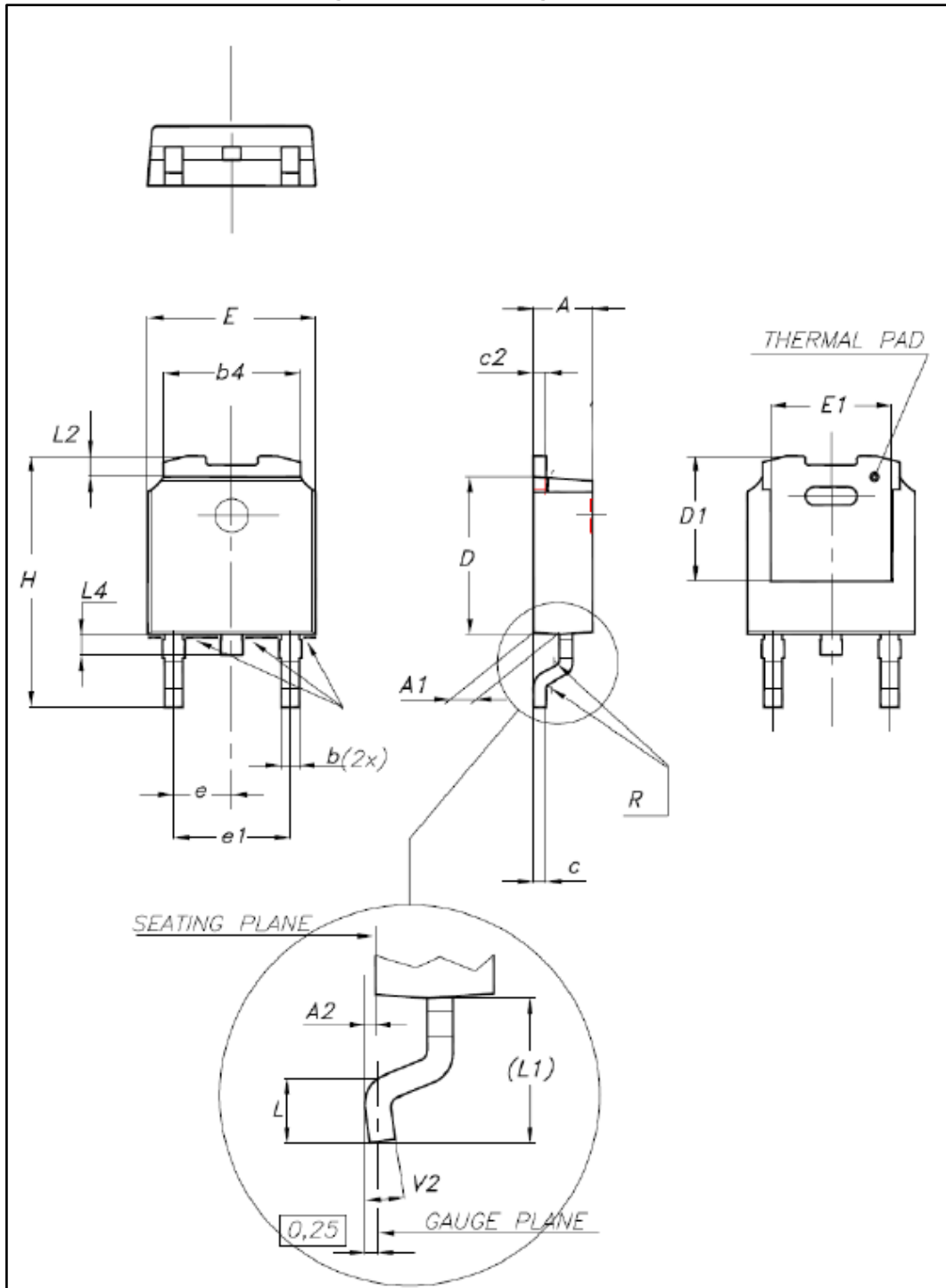

This package drawing may slightly differ from the physical package. However, all the specified dimensions are guaranteed.

Table 5: DPAK package mechanical data

Ref.	Dimensions			
	Millimeters		Inches	
	Min.	Max.	Min.	Max.
A	2.18	2.40	0.085	0.094
A1	0.90	1.10	0.035	0.043
A2	0.03	0.23	0.001	0.009
b	0.64	0.90	0.025	0.035
b4	4.95	5.46	0.194	0.215
c	0.46	0.61	0.018	0.024
c2	0.46	0.60	0.018	0.023
D	5.97	6.22	0.235	0.244
D1	4.95	5.60	0.194	0.220
E	6.35	6.73	0.250	0.265
E1	4.32	5.50	0.170	0.216
e	2.286 typ.		0.090 typ.	
e1	4.40	4.70	0.173	0.185
H	9.35	10.40	0.368	0.409
L	1.0	1.78	0.039	0.070
L2		1.27		0.050
L4	0.60	1.02	0.023	0.040
V2	-8°	+8°	-8°	+8°

Figure 10: DPAK recommended footprint (dimensions in mm)

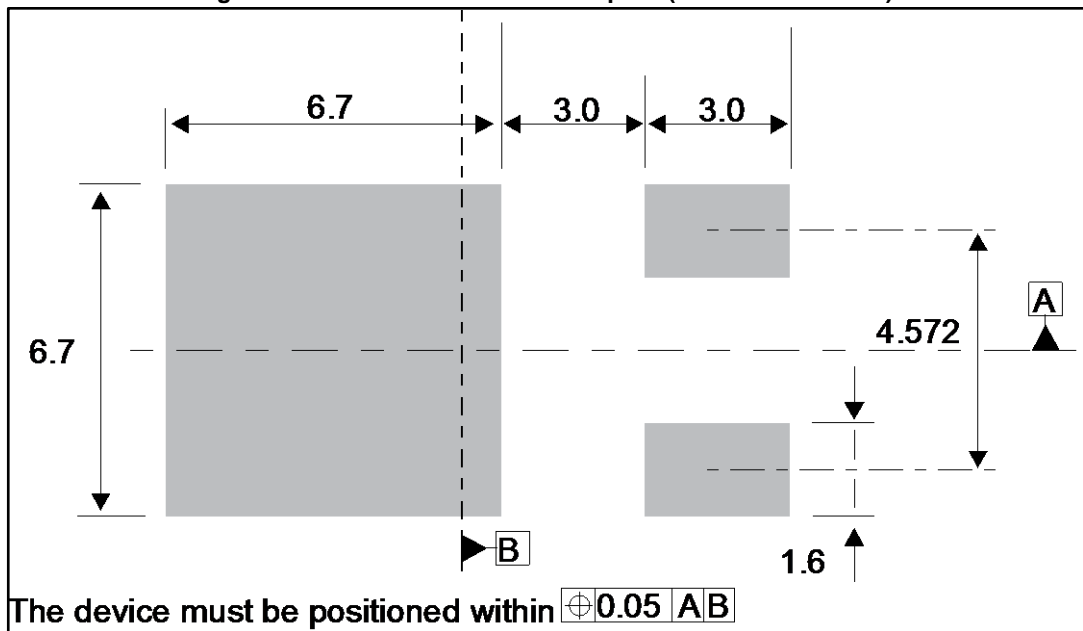

### 3 Ordering information

Table 6: Ordering information

Order code	Marking	Package	Weight	Base qty.	Delivery mode
STPS8L30B-TR	LS 30	DPAK	0.32 g	2500	Tape and reel

### 4 Revision history

Table 7: Document revision history

Date	Revision	Changes
Jul-2002	2A	First issue
16-Apr-2005	3	IPAK package Added.
01-Mar-2006	4	IPAK connector identifiers corrected on page 1. ECOPACK statement added. Document reformatted to current standard.
18-Oct-2016	5	Updated DPAK package information and reformatted to current standard. Removed IPAK package.



**IMPORTANT NOTICE – PLEASE READ CAREFULLY**

STMicroelectronics NV and its subsidiaries ("ST") reserve the right to make changes, corrections, enhancements, modifications, and improvements to ST products and/or to this document at any time without notice. Purchasers should obtain the latest relevant information on ST products before placing orders. ST products are sold pursuant to ST's terms and conditions of sale in place at the time of order acknowledgement.

Purchasers are solely responsible for the choice, selection, and use of ST products and ST assumes no liability for application assistance or the design of Purchasers' products.

No license, express or implied, to any intellectual property right is granted by ST herein.

Resale of ST products with provisions different from the information set forth herein shall void any warranty granted by ST for such product.

ST and the ST logo are trademarks of ST. All other product or service names are the property of their respective owners.

Information in this document supersedes and replaces information previously supplied in any prior versions of this document.

© 2016 STMicroelectronics – All rights reserved