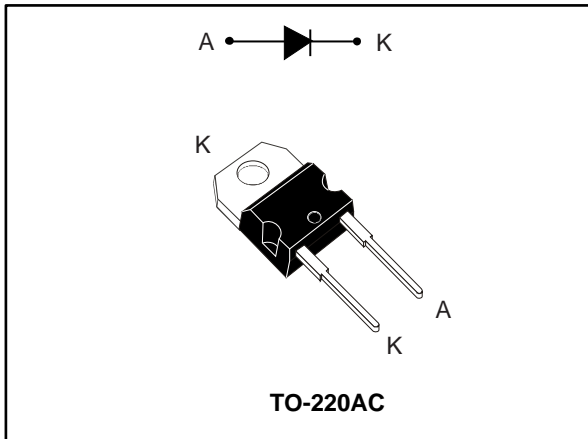

## Field-effect rectifier

Datasheet - production data

**Description**

This single field effect rectifier provides stable leakage current over the full range of reverse voltage and low forward voltage drop.

Packaged in TO-220AC, this device is intended to be used in solar bypass junction boxes and in switch mode power supplies.

**Table 1: Device summary**

Symbol	Value
$I_{F(AV)}$	30 A
$V_{RRM}$	45 V
$V_F$ (typ.)	0.44 V
$T_j$ (max.)	175 °C (up to 200 °C forward mode)

**Features**

- ST advanced rectifier process
- Stable leakage current over reverse voltage
- Reduced leakage current
- Low forward voltage drop
- High frequency operation

# 1 Characteristics

**Table 2: Absolute ratings (limiting values at 25 °C, unless otherwise specified)**

Symbol	Parameter		Value	Unit
V <sub>RRM</sub>	Repetitive peak reverse voltage		45	V
I <sub>F(RMS)</sub>	Forward rms current		60	A
I <sub>F(AV)</sub>	Average forward current $\delta = 0.5$ , square wave	T <sub>C</sub> = 150 °C	30	A
I <sub>FSM</sub>	Surge non repetitive forward current	t <sub>p</sub> = 10 ms sinusoidal	250	A
T <sub>stg</sub>	Storage temperature range		-65 to +175	°C
T <sub>j</sub>	Maximum operating junction temperature <sup>(1)</sup>		+175	°C
T <sub>j</sub>	Non repetitive operating junction temperature (DC forward current without reverse bias, t = 1 hour)		200	°C

**Notes:**

<sup>(1)</sup>(dP<sub>tot</sub>/dT<sub>j</sub>) < (1/R<sub>th(j-a)</sub>) condition to avoid thermal runaway for a diode on its own heatsink.

**Table 3: Thermal resistance parameters**

Symbol	Parameter	Value	Unit
R <sub>th(j-c)</sub>	Junction to case	1.05	°C/W

**Table 4: Static electrical characteristics**

Symbol	Parameter	Test conditions		Min.	Typ.	Max.	Unit
I <sub>R</sub> <sup>(1)</sup>	Reverse leakage current	T <sub>j</sub> = 25 °C	V <sub>R</sub> = V <sub>RRM</sub>	-		1.2	mA
		T <sub>j</sub> = 125 °C		-	50	100	
V <sub>F</sub> <sup>(2)</sup>	Forward voltage drop	T <sub>j</sub> = 125 °C	I <sub>F</sub> = 7.5 A	-	0.26	0.31	V
		T <sub>j</sub> = 25 °C	I <sub>F</sub> = 15 A	-	0.37	0.42	
		T <sub>j</sub> = 125 °C		-	0.33	0.38	
		T <sub>j</sub> = 125 °C		I <sub>F</sub> = 30 A	-	0.44	

**Notes:**

<sup>(1)</sup>Pulse test: t<sub>p</sub> = 5 ms,  $\delta < 2\%$

<sup>(2)</sup>Pulse test: t<sub>p</sub> = 380  $\mu$ s,  $\delta < 2\%$

To evaluate the conduction losses, use the following equation:

$$P = 0.27 \times I_{F(AV)} + 0.007 \times I_{F(RMS)}^2$$

# 1.1 Characteristics (curves)

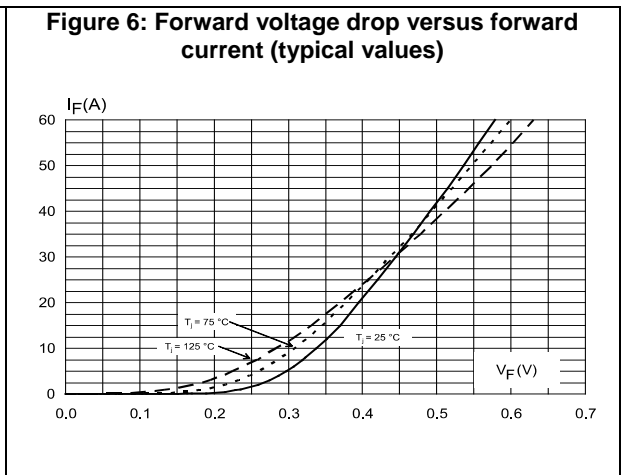
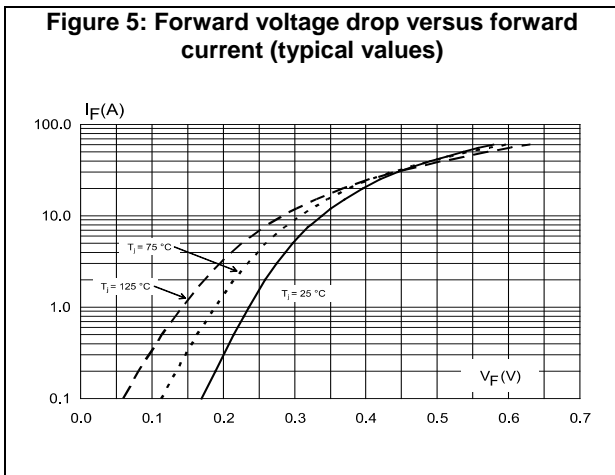
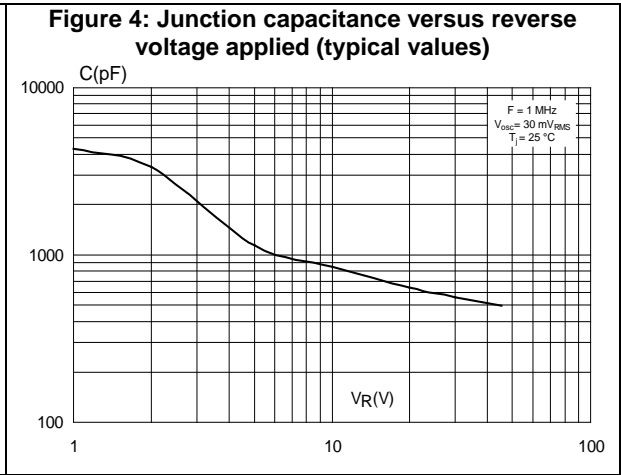
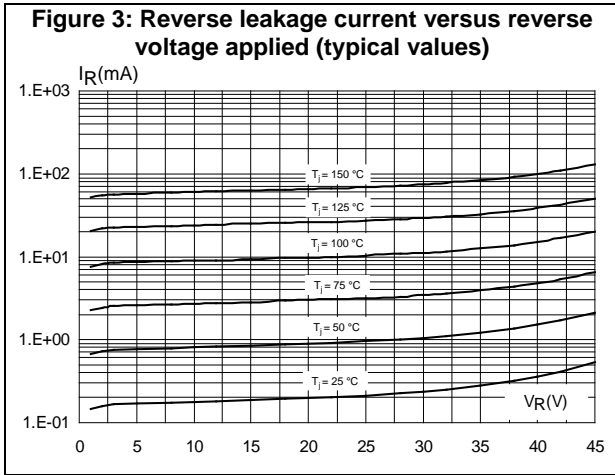
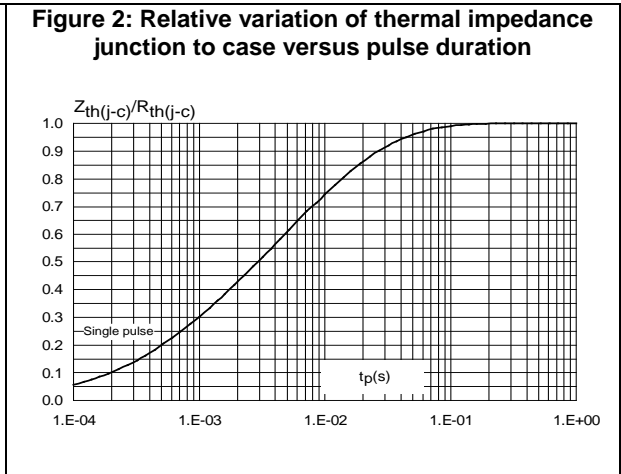
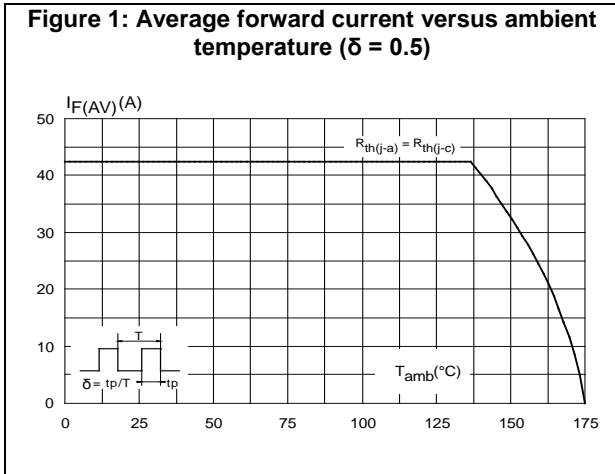

## 2 Package information

In order to meet environmental requirements, ST offers these devices in different grades of ECOPACK® packages, depending on their level of environmental compliance. ECOPACK® specifications, grade definitions and product status are available at: [www.st.com](http://www.st.com). ECOPACK® is an ST trademark.

- Epoxy meets UL94, V0
- Cooling method: by conduction (C)
- Recommended torque value: 0.55 N·m
- Maximum torque value: 0.7 N·m

### 2.1 TO-220AC package information

Figure 7: TO-220AC package outline

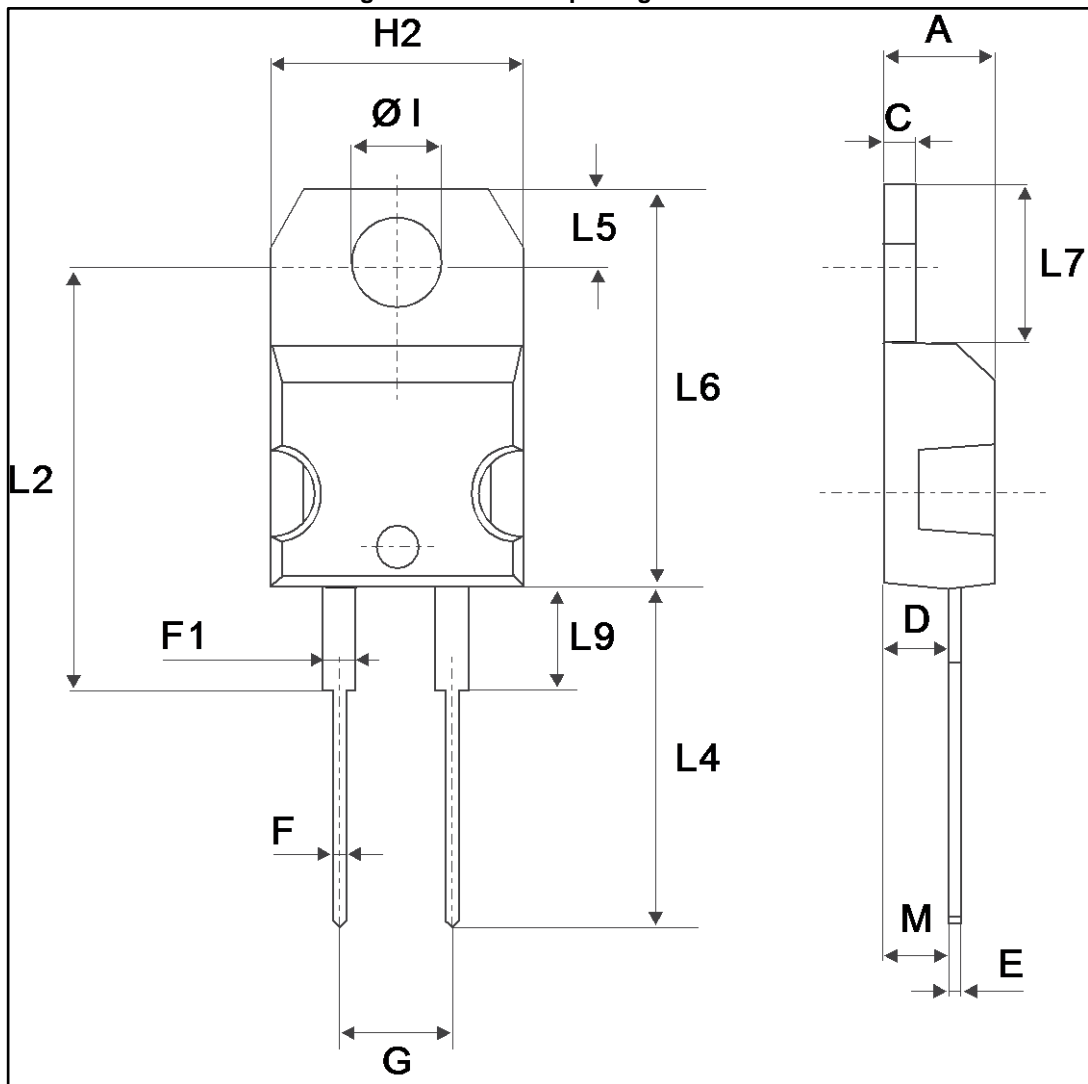

Table 5: TO-220AC package mechanical data

Ref.	Dimensions			
	Millimeters		Inches	
	Min.	Max.	Min.	Max.
A	4.40	4.60	0.173	0.181
C	1.23	1.32	0.048	0.051
D	2.40	2.72	0.094	0.107
E	0.49	0.70	0.019	0.027
F	0.61	0.88	0.024	0.034
F1	1.14	1.70	0.044	0.066
G	4.95	5.15	0.194	0.202
H2	10.00	10.40	0.393	0.409
L2	16.40 typ.		0.645 typ.	
L4	13.00	14.00	0.511	0.551
L5	2.65	2.95	0.104	0.116
L6	15.25	15.75	0.600	0.620
L7	6.20	6.60	0.244	0.259
L9	3.50	3.93	0.137	0.154
M	2.6 typ.		0.102 typ.	
Diam	3.75	3.85	0.147	0.151

### 3 Ordering information

Table 6: Ordering information

Order code	Marking	Package	Weight	Base qty.	Delivery mode
FERD30M45D	FERD30M45D	TO-220AC	1.86 g	50	Tube

### 4 Revision history

Table 7: Document revision history

Date	Revision	Changes
02-May-2016	1	Initial release.
07-Oct-2016	2	Updated <a href="#">Table 2</a> : "Absolute ratings (limiting values at 25 °C, unless otherwise specified)".

**IMPORTANT NOTICE – PLEASE READ CAREFULLY**

STMicroelectronics NV and its subsidiaries ("ST") reserve the right to make changes, corrections, enhancements, modifications, and improvements to ST products and/or to this document at any time without notice. Purchasers should obtain the latest relevant information on ST products before placing orders. ST products are sold pursuant to ST's terms and conditions of sale in place at the time of order acknowledgement.

Purchasers are solely responsible for the choice, selection, and use of ST products and ST assumes no liability for application assistance or the design of Purchasers' products.

No license, express or implied, to any intellectual property right is granted by ST herein.

Resale of ST products with provisions different from the information set forth herein shall void any warranty granted by ST for such product.

ST and the ST logo are trademarks of ST. All other product or service names are the property of their respective owners.

Information in this document supersedes and replaces information previously supplied in any prior versions of this document.

© 2016 STMicroelectronics – All rights reserved