

S. C345253.0

DO NOT SCALE

DIMENSIONS IN MM.

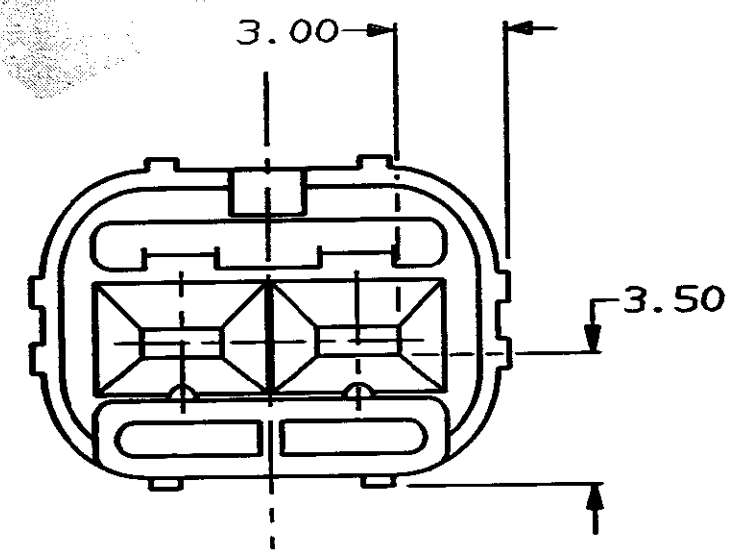
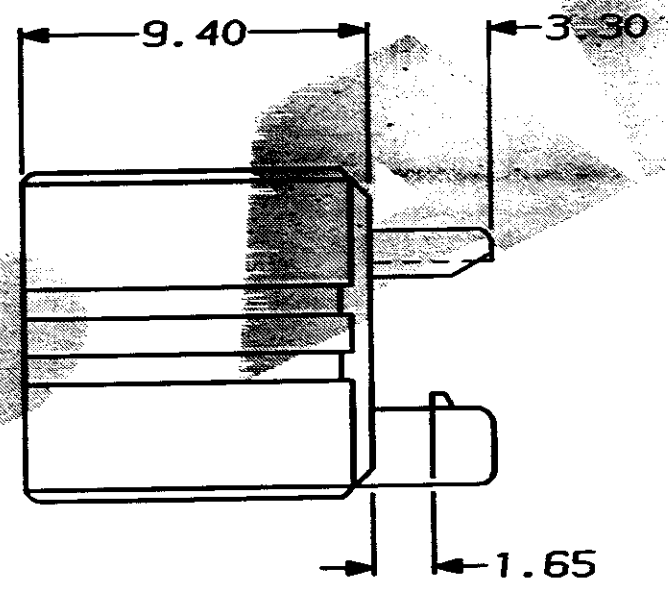
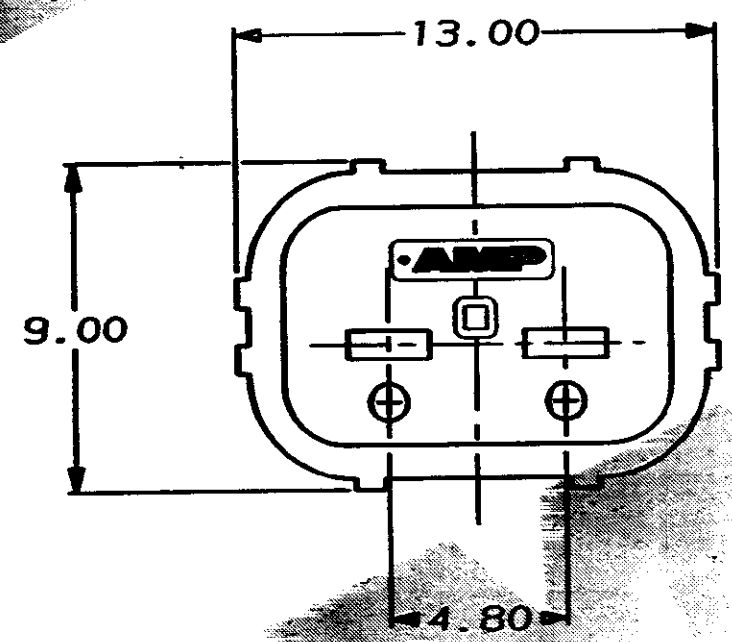
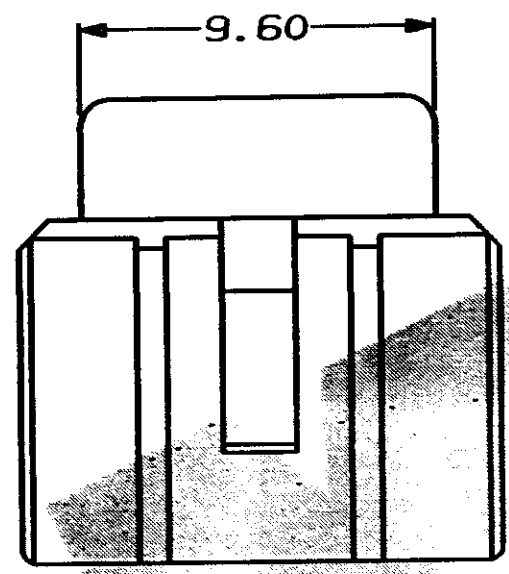

NOTE

THIS PART IS USED ON Pt.No. 344274-1

YELLOW		NYLON 66		345253-1	
COLOUR		MATERIAL		PART NUMBER	
CUSTOMER DWG FOR REFERENCE ONLY		© COPYRIGHT 1989 BY AMP OF GREAT BRITAIN LTD. ALL INTERNATIONAL RIGHTS RESERVED. ALL PRODUCTS MAY BE COVERED BY BRITISH AND FOREIGN PATENTS AND/OR PATENTS PENDING.		RELEASED FOR PUBLICATION 05 DEC 1989	
		TOLERANCES UNLESS OTHERWISE STATED : DEC ± 0.5 ANGLES ± 1°		DR. R. RUNAGALL. 05/12/89 CH. D.R. TERRY APP. R. SIMMONS.	
		NAME A/BACKOUT FOR 2 WAY TAB HSG. ECONOSEAL 3 LOW CURRENT		TERMINAL HOUSE STAMFORD MIDD.	
0	REL. FOR PRODUCTION	CS380	16/08/90	SCALE 5/1	LOC E
REV	APPROVED	ECN	DATE	SIZE A3	DWG.No. C345253
					REV 0
					SHEET 1/1