

PROPER USE GUIDELINES

Cumulative Trauma Disorders can result from the prolonged use of manually powered hand tools. Hand tools are intended for occasional use and low volume applications. A wide selection of powered application equipment for extended-use, production operations is available.

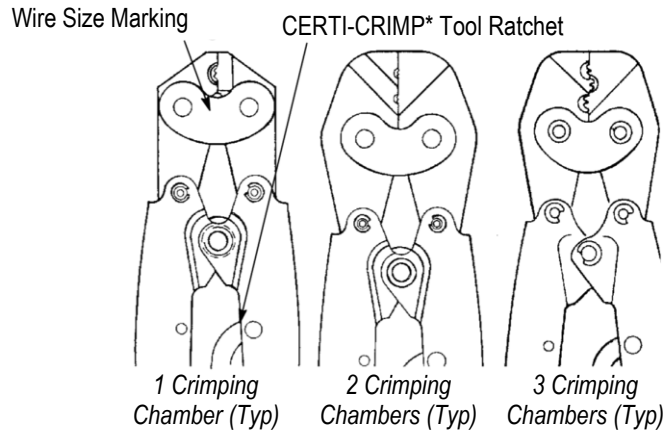

Figure 1

1. INTRODUCTION

Hand Crimping Tools 46447, 47410 (crimps 12-10 AWG terminals on a 45° angle), 49592, 49935, 69363, 525693, 574573, 1490046-1, and 1490047-1 (shown in Figure 1) are used to crimp SOLISTRAND* and STRATO-THERM* terminals and splices (listed in Figure 2) onto stranded wire sizes 26 through 10 AWG.

Read these instructions thoroughly before using the tool.



NOTE

Dimensions in this instruction sheet are in millimeters [with inch equivalents in brackets]. Figures and illustrations are for reference only, and are not drawn to scale.

Reasons for reissue of this instruction sheet are provided in Section 7, REVISION SUMMARY.

2. DESCRIPTION

Each tool consists of a CERTI-CRIMP tool ratchet and two crimping jaws (indenter and anvil) containing one, two, or three crimping chambers. Each tool is marked with the wire size range for each crimping chamber. See Figure 1. Full crimping of the terminal or splice is assured by the CERTI-CRIMP tool ratchet. Once engaged, the ratchet does not release until the tool handles have been FULLY closed.



CAUTION

The crimping jaws bottom before the ratchet releases. This feature ensures maximum electrical and tensile performance of the crimp. Do NOT re-adjust the ratchet.

3. CRIMPING PROCEDURE

Strip the wire according to the dimensions listed in Figure 2. The strip length is determined by the type of terminal or splice and by the wire size. Do not nick or cut the wire strands. Proceed as follows:

1. Close the tool handles until the ratchet releases. Allow the tool handles to open fully.
2. Center the terminal or splice wire barrel in the appropriate crimping chamber. For terminals, make sure that the flat side of the tongue faces the anvil or the nest; for splices, make sure that the brazed seam (when visible) is toward the indenter or, the nest. See Figure 3.
3. While holding the terminal or splice in place, squeeze the tool handles together just until the jaws begin to close on the wire barrel. Do NOT deform the wire barrel.
4. Insert the stripped wire into the wire barrel, making sure that the wire insulation does not enter the wire barrel.

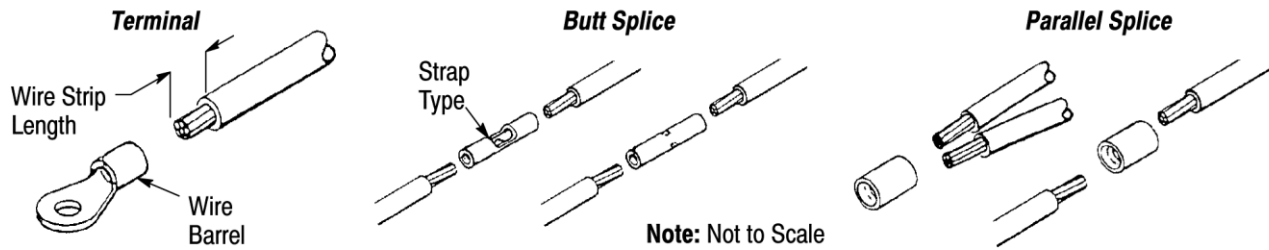

PRODUCT	HAND TOOL	WIRE SIZE (AWG) RANGE AND TERMINAL SIZE	CRIMPING CHAMBER MARKING	WIRES STRIP LENGTH			
				TERMINAL (STANDARD)	TERMINAL (LONG BARREL)	BUTT SPLICE	PARALLEL SPLICE
STRATO-THERM	46447	22-16	22-16	4.37-5.16 [.172-.203]	---	6.35-7.14 [.250-.281]	7.94-8.73 [.313-.344]
		16-14	16-14	6.35-7.14 [.250-.281]			
		12-10	12-10	6.35-7.14 [.250-.281]			
SOLISTRAND	49592	14-12	14-12	4.37-5.16 [.172-.203]	---	7.94-8.73 [.313-.344]	---
	49935 525693 574573	22-16	22-16	4.37-5.16 [.172-.203]	6.35-7.14 [.250-.281]	6.35-7.14 [.250-.281]	7.94-8.73 [.313-.344]
	49935 525693 574573 1490046-1	16-14	16-14	4.37-5.16 [.172-.203]	6.35-7.14 [.250-.281]	6.35-7.14 [.250-.281]	7.94-8.73 [.313-.344]
	47410 49935 525693 574573 1490047-1	12-10	12-10	6.35-7.14 [.250-.281]	---	6.35-7.14 [.250-.281]	---
	69363	26-24	26-24	3.17-3.97 [.125-.156]	---	3.57-4.37 [.141-.172]	---
		22-20	22-20	4.37-5.16 [.172-.203]	---	5.16-5.95 [.203-.234]	---
24-20		22-20	---	---	4.37-5.16 [.172-.203]	---	

Figure 2

5. While holding the wire in place, squeeze the tool handles together until the ratchet releases, then allow the tool handles to open fully.
6. To crimp the other half of a butt splice, position the uncrimped wire barrel in the crimping chamber, and repeat the crimping procedure.

i **NOTE**
If splice cannot be turned for crimping other half, turn the tool around.

i **NOTE**
Terminals and splices can also be rotated 180° with the seam toward the nest.

4. CRIMP INSPECTION

Inspect crimped terminals and splices by checking the features described in Figure 4. Poor crimps can be avoided by carefully following the procedures provided in Section 3, and by following the tool maintenance procedures provided in Section 5.

Terminals and Splices Can Also Be Rotated 180° with the Seam Toward the Nest

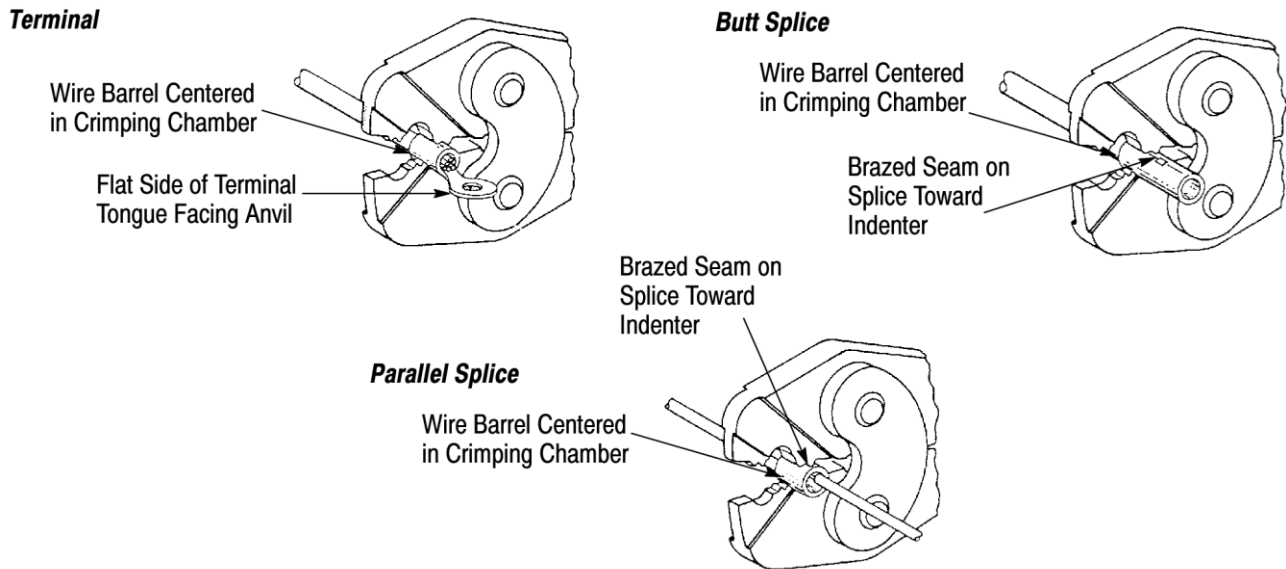

Figure 3

5. MAINTENANCE AND INSPECTION

The tool is inspected before being shipped, however TE recommends that the tool be inspected immediately upon arrival at your facility to ensure that the tool has not been damaged during shipment.

Frequency of inspection depends on:

1. The care, amount of use, and handling of the hand tool.
2. The presence of abnormal amounts of dust and dirt.
3. The degree of operator skill; and
4. Your own established standards.

5.1. Daily Maintenance

1. Remove dust, moisture, and other contaminants with a clean brush, or a soft, lint-free cloth. Do NOT use objects that could damage the tool.
2. Make certain that the retaining pins are in place and that they are secured with retaining rings.
3. All pins, pivot points, and bearing surfaces should be protected with a thin coat of any good SAE 20 motor oil. Do NOT oil excessively.
4. When the tool is not in use, keep handles closed to prevent objects from becoming lodged in the crimping jaws. Store the tool in a clean, dry area.

5.2. Lubrication

Lubricate all pins, pivot points, and bearing surfaces with SAE 20 motor oil as follows:

- Tools used in daily production - lubricate daily
- Tools used daily (occasional) - lubricate weekly
- Tools used weekly - lubricate monthly

Wipe excess oil from tool, particularly from crimping area. Oil transferred from the crimping area onto certain terminations may affect the electrical characteristics of an application.

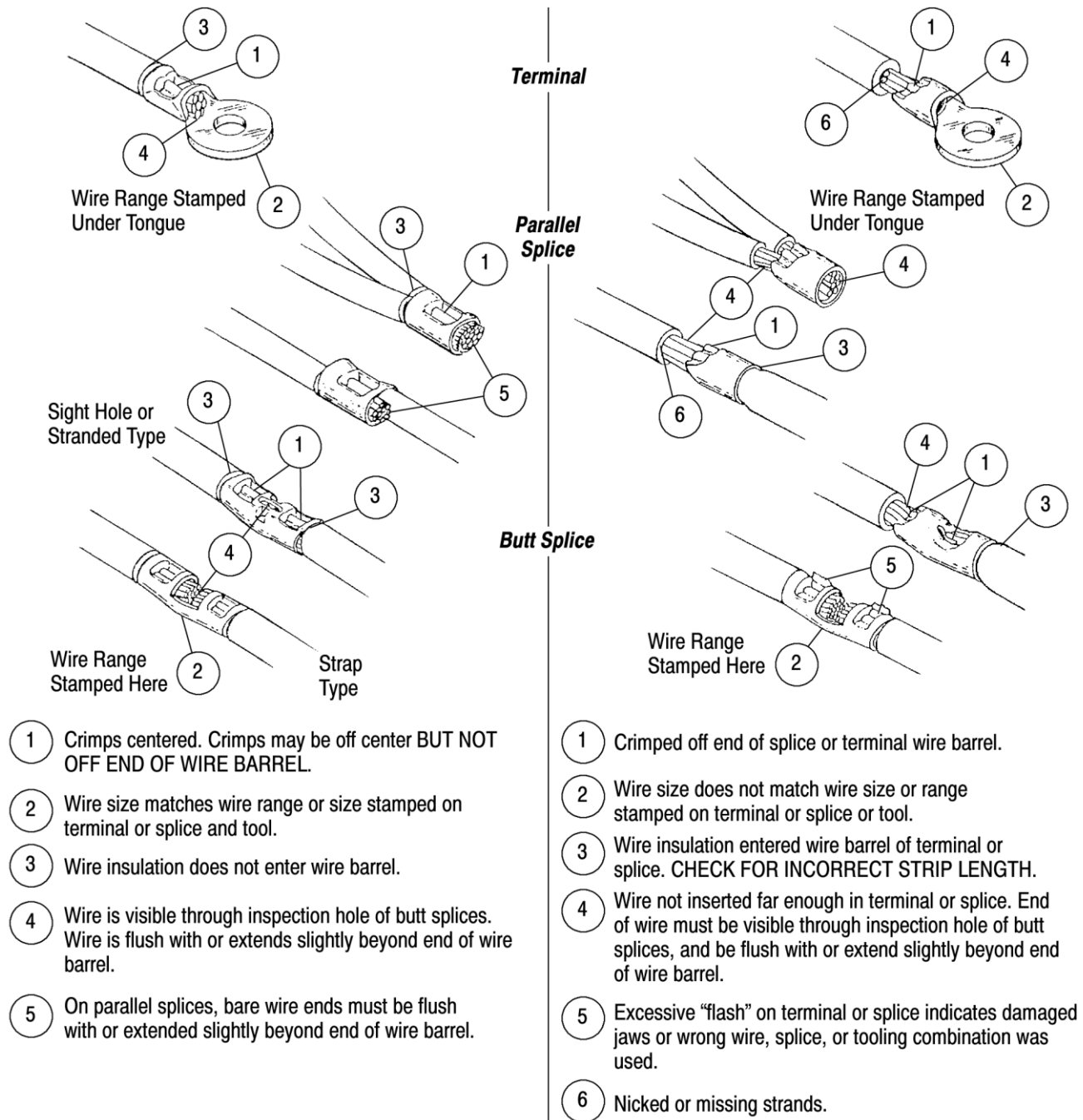

Figure 4

5.3. Periodic Inspection

1. The tool should be immersed (handles partially closed) in a reliable commercial degreasing compound to remove accumulated dirt, grease, and foreign matter.
2. Close tool handles until ratchet releases and then allow them to open freely. If they do not open quickly and fully, the spring is defective and must be replaced. See Section 6, REPLACEMENT AND REPAIR.
3. Inspect head assembly for worn, cracked, or broken jaws. Refer to Figure 5. If damage is evident, return the tool to TE for evaluation and repair. See Section 6, REPLACEMENT AND REPAIR.

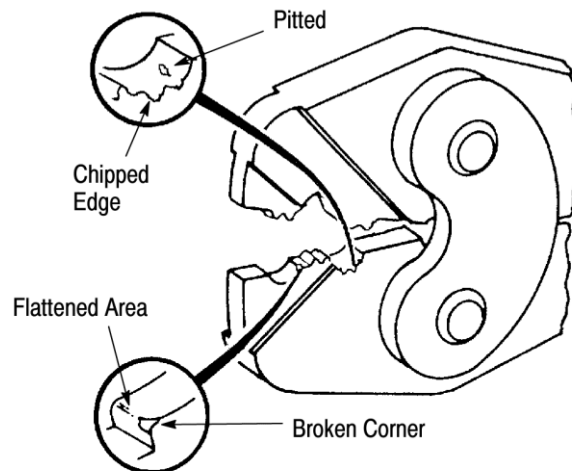

Figure 5

5.4. Gaging the Crimping Chambers (Figure 7)

This inspection requires the use of a plug gage conforming to the dimensions provided in Figure 6.

TE does not manufacture or market these gages. To gage the crimping chambers, proceed as follows:

Remove traces of oil or dirt from the crimping chambers and plug gage.

1. Close the tool handles until it is evident that the jaws have bottomed; then hold in this position. Do NOT force the jaws beyond initial contact.
2. Align the GO element with the crimping chamber. Push element straight into the crimping chamber without using force. The GO element must pass completely through the crimping chamber.
3. Align the NO-GO element and try to insert it straight into the same crimping chamber. The NO-GO element may start entry, but must not pass completely through the crimping chamber.



NOTE

The jaws in Tools 49935 and 574573 are not symmetrically located; make sure that the tool conforms to the symmetry requirements shown in Figure 8.

If the crimping chambers conforms to the gage inspection, the tool is considered dimensionally correct, and should be lubricated with a THIN coat of any good SAE 20 motor oil. If not, the tool must be returned for further evaluation and repair. Refer to Section 6, REPLACEMENT AND REPAIR.

For additional information regarding the use of a plug gage, refer to Instruction Sheet [408-7424](#).

5.5. Ratchet Inspection

The CERTI-CRIMP tool ratchet should be checked to ensure that the ratchet does not release prematurely, allowing the jaws to open before they have fully bottomed. Obtain a 0.025 mm [.001 in.] shim suitable for checking the clearance between the bottoming surfaces of the crimping jaws. Proceed as follows:

1. Select a terminal or splice, and properly stripped wire with *maximum* wire load (such as wire size 16 AWG and size 22-16 terminal).
2. Position the terminal or splice and wire between the crimping jaws, as described in Section 3.
3. Hold the wire in place and squeeze the handles until the CERTI-CRIMP tool ratchet releases. Hold the handles in this position, maintaining just enough tension to keep the jaws closed.
4. Check the clearance between the bottoming surfaces of the crimping jaws. If the clearance is 0.025 mm [.001 in.] or less, the ratchet is satisfactory. If clearance exceeds 0.025 mm [.001 in.], the ratchet is out of adjustment and must be repaired. See Section 6, REPLACEMENT AND REPAIR.

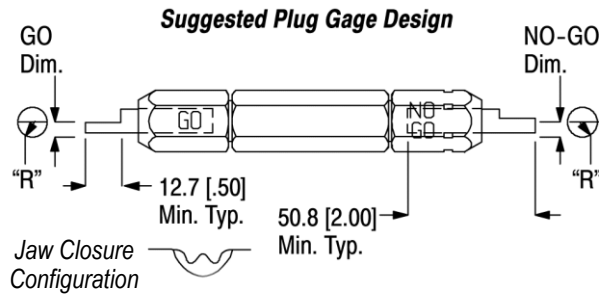

HAND TOOL	CRIMPING CHAMBER MARKING	GAGE ELEMENT DIMENSIONS		
		GO	NO-GO	“R”
46447	22-16	1.295-1.303 [.0510-.0513]	1.445-1.447 [.0569-.0570]	1.57 [.062]
	16-14	1.498-1.506 [.0590-.0593]	1.648-1.651 [.0649-.0650]	1.57 [.062]
	12-10	2.108-2.116 [.0830-.0833]	2.258-2.260 [.0889-.0890]	2.36 [.093]
49592	14-12	1.752-1.760 [.0690-.0693]	1.902-1.905 [.0749-.0750]	1.57 [.062]
49935 525623 574573	22-16	1.168-1.176 [.0460-.0463]	1.318-1.320 [.0519-.0520]	1.57 [.062]
49935 525693 574573 1490046-1	16-14	1.371-1.379 [.0540-.0543]	1.521-1.524 [.0599-.060]	1.98 [.078]
47410 49935 525693 574573 1490047-1	12-10	1.930-1.938 [.0760-.0763]	2.080-2.082 [.0819-.082]	2.76 [.109]
69363	26-24	0.660-0.668 [.026-.0263]	0.810-0.812 [.0319-.032]	1.003 [.0395]
	22-20	0.939-0.947 [.037-.0373]	1.089-1.092 [.0429-.043]	1.19 [.047]

Figure 6

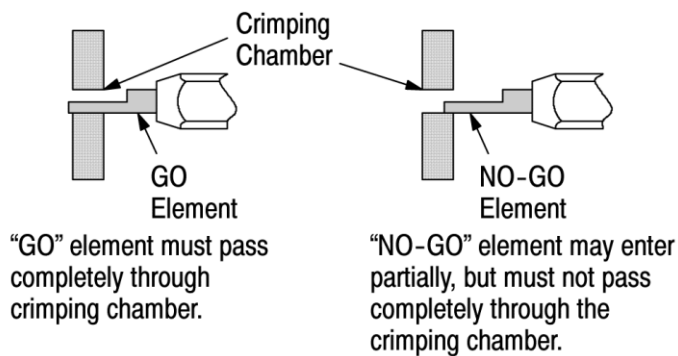

Figure 7

6. REPLACEMENT AND REPAIR

Customer-replaceable parts are listed in Figure 9. A complete inventory should be stocked and controlled to prevent lost time when replacement of parts is necessary. Parts other than those listed should be replaced by TE to ensure quality and reliability. Order replacement parts through your TE Representative, or call 1-800-526-5142, or send a facsimile of your purchase order to 717-986-7605, or write to:

CUSTOMER SERVICE (038-035)
 TYCO ELECTRONICS CORPORATION
 PO BOX 3608
 HARRISBURG PA 17105-3608

Tools may also be returned to TE for evaluation and repair. For customer repair service, please contact a TE Representative at 1-800-526-5136.

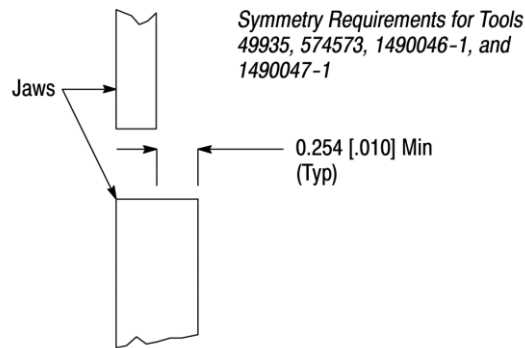
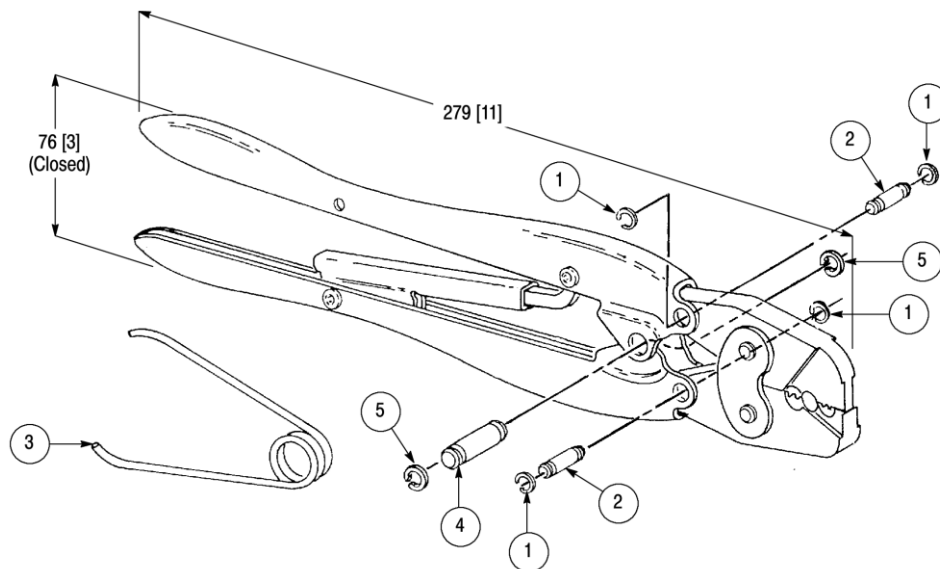

Figure 8



REPLACEMENT PARTS

ITEM	PART NUMBER	DESCRIPTION	QTY PER TOOL	525693 TOOL ONLY
1	21045-3	RING, Retaining	4	---
2	1-23619-6	PIN, Straight, Grooved	2	2
3	39364	SPRING, Hold Down	1	---
4	2-23620-9	PIN, Straight, Grooved	1	1
5	21045-6	RING, Retaining	2	2
6	525108	RING, Retaining, Beryl Copper	---	4

Figure 9

7. REVISION SUMMARY

- Updated document to corporate requirements
- Corrected tool numbers in table 2
- Merged Figures 6 and 8 and renumbered