

PROPER USE GUIDELINES

Cumulative Trauma Disorders can result from the prolonged use of manually powered hand tools. Hand tools are intended for occasional use and low volume applications. A wide selection of powered application equipment for extended-use, production operations is available.

Tooling for Loose-Piece Contacts

4/8-Indent Hand Crimping Tool
(Typ, Requires Positioner or
Turret Head)

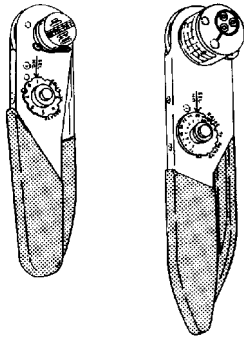

Insertion/Extraction
Tool (Typ)

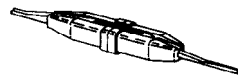

Extraction Tool (Typ)

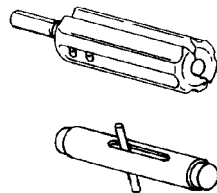

Tooling for Tape Mounted Contacts

AMP-TAPETRONIC* 4/8 Indent Stripper
Terminator 599406-[] (Requires Funnel)

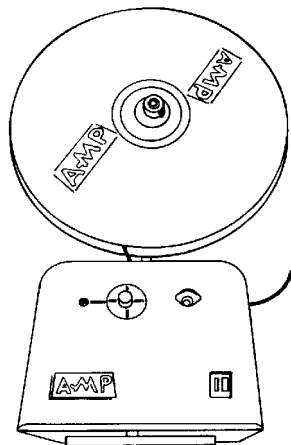

Figure 1

1. INTRODUCTION

This instruction sheet covers tooling selections for crimping, inserting, and extracting screw-machine contacts, and manual application procedures. Application procedures for the other tools are packaged with the tool. Read these instructions thoroughly before making any selections.

NOTE



Dimensions in this instruction sheet are in millimeters [with inches in brackets]. Figures and illustrations are for reference only and are not drawn to scale.

Reasons for reissue of this instruction sheet are provided in Section 7, REVISION SUMMARY.

2. DESCRIPTION

The screw-machine contacts are supplied in loose-piece for manual (4/8-indent hand crimping tools) application and tape mounted for power assisted (machine) application. Insertion and extraction tools are used to insert contacts into and extract contacts from connectors. See Figure 1.

The military uses a standardized numbering system which pertains to the tools that are qualified to military specifications (spec). Refer to Figure 2 for a cross-reference of these tools.

Description	Part Number	Military Spec
4/8-Indent Hand Crimping Tool	601966-1	MIL-C-22520/2-01
	601967-1	MIL-C-22520/1-01
	608651-1	---
Positioner or Turret Head	601966-2	MIL-C-22520/2-02
	601966-4	MIL-C-22520/2-06
	601966-5	MIL-C-22520/2-08
	601966-6	MIL-C-22520/2-09
	601966-8	MIL-C-22520/2-23
	601967-2	MIL-C-22520/1-02
	1-601967-2	MIL-C-22520/1-11
Insertion/Extraction Tool	91066-1	MIL-I-81969/1-01 or MS3156-22
	91067-1	MIL-I-81969/1-04
	91067-2	MIL-I-81969/1-02 or MS3156-20
Extraction Tool	91066-3	MIL-I-81969/1-03 or MS3156-16
	445147-1	MIL-C-81969/28-02
	58284-1	MIL-C-81969/28-03
	91074-1	MIL-C-81969/28-01 or MS3178-001

Figure 2

Refer to Figure 3 for proper contact and tooling combination. Read the chart from the left page across to the right page.

Product Line	CONTACT				WIRE		TOOL SELECTOR SETTING	
	Size	Pin	Socket	Military Spec	Size (AWG)	Strip Length		
Type II Contact For Multimate Connectors	20	201607	201609	—	28	5.16 [.203]	2	
					26		2	
					24		3	
		—	201353	—	—	28	5.16 [.203]	2
						26		2
						24		3
		201582	201584-6	—	—	24	5.16 [.203]	1
						22		2
						20		3
		200334	200331	—	—	24	5.16 [.203]	1
						22		2
						20		3
		—	201589	—	—	18	6.35 [.250]	4
						16		5
		16	—	201554	—	—	32	5.16 [.203]
	30						1	
	201334		—	—	—	28	5.16 [.203]	2
	—		201332	—	—	26		2
						24	3	
	201611		—	—	—	28	5.16 [.203]	2
	—		201613	—	—	26		2
						24	3	
	201578		—	—	—	22	5.16 [.203]	2
	—		201580	—	—	20		3
	200679		201328	—	—	24	5.16 [.203]	1
	201330		—	—	—	22		2
	204188		—			20		3
	200681		200333	—	—	18	6.35 [.250]	4
	202507		—	—	—	16		5
		18				4		
—	202508	—	—	16	6.35 [.250]	5		
				18		4		
200336	200333	—	—	16	6.35 [.250]	5		
				14		5		
201570	201568	—	—	14	5.16 [.203]	5		
201555	—	—	—	32		1		
—	201554	—	—	30		1		

Figure 3 (Cont'd)

	Tooling for Loose Piece Contacts		Tooling for Tape Mounted Contacts		CONNECTOR Military Spec	INSERTION TOOL	EXTRACTION TOOL
	Positioner or Turret Head	Hand Crimping Tool	Machine	Funnel			
→	1-601967-5	58305-1 or 601967-1	—	—	—	200893-2 or 91002-1	305183
	1-601967-5	58305-1 or 601967-1	—	—	—	200893-2 or 91002-1	305183
	1-601967-5	58305-1 or 601967-1	—	—	—	200893-2 or 91002-1	305183
	1-601967-5	58305-1 or 601967-1	—	—	—	200893-2 or 91002-1	305183
	1-601967-6	45098 or 601967-1	—	—	—	200893-2 or 91002-1	305183
	1-601967-5	58305-1 or 601967-1	—	—	—	200893-2 or 91002-1	305183
→	1-601967-6	58305-1 or 601967-1	—	—	—	200893-2 or 91002-1	305183
	1-601967-5						
	1-601967-6	58305-1 or 601967-1	—	—	—	200893-2 or 91002-1	305183
	1-601967-5						
	1-601967-6	58305-1 or 601967-1	—	—	—	200893-2 or 91002-1	305183
	1-601967-5						
	1-601967-5	58305-1 or 601967-1	—	—	—	200893-2 or 91002-1	305183
	1-601967-6						
	1-601967-6	45098 or 601967-1	—	—	—	200893-2 or 91002-1	305183
	1-601967-6	90136-1 or 601967-1	—	—	—	200893-2 or 91002-1	305183
	1-601967-5						
	1-601967-6	45098 or 601967-1	—	—	—	200893-2 or 91002-1	305183
						—	
	1-601967-6	58305-1 or 601967-1	—	—	—	200893-2 or 91002-1	305183
	1-601967-5						

Figure 3 (Cont'd)

Product Line	CONTACT				WIRE		TOOL SELECTOR SETTING
	Size	Pin	Socket	Military Spec	Size (AWG)	Strip Length	
Type II Contact For Multimate Connectors	16	—	201609	—	28	5.16 [.203]	2
					26		2
					24		3
		—	201332	—	26	5.16 [.203]	2
					24		3
		200679	201328	—	24	5.16 [.203]	1
					22		2
					20		3
		200681	200333	—	18	5.16 [.203]	4
		200336	—	—	16		5
		204274	—	—	18	5.16 [.203]	4
		202507	—	—	18		4
		204219	202508	—	16		5
		202725	202726	—	18 ^②	5.16 [.203]	5
		201570	—	—	14	5.16 [.203]	5
201645	—	—	5				
—	201568	—	5				
Type VII Contact For Subminiature Connectors	22	202123	202124	—	32 ^①	3.18 [.125]	1
					30 ^①		1
					28		2
					26		2
		204092	—	—	30 ^①	3.18 [.125]	1
					28		2
					26		3
					24		4
Type XIII Contact For Terminal Junction (TJG) Modules	20	203669-4	—	—	24	4.78 [.188]	5
					22		6
					20		7

Figure 3 (Cont'd)

① This wire size is not recommended for use in the machine.

② Refer to the instruction sheet (408-series) packaged with the contact for wire strip length.

	Tooling for Loose Piece Contacts		Tooling for Tape Mounted Contacts		CONNECTOR Military Spec	INSERTION TOOL	EXTRACTION TOOL
	Positioner or Turret Head	Hand Crimping Tool	Machine	Funnel			
→	1-601967-5	58305-1 or 601967-1	—	—	—	200893-2 or 91002-1	305183
	1-601967-5	58305-1 or 601967-1	—	—	—	200893-2 or 91002-1	305183
	1-601967-5	58305-1 or 601967-1	—	—	—	200893-2 or 91002-1	305183
	1-601967-6	45098 or 601967-1	—	—	—	200893-2 or 91002-1	305183
	1-601967-6	45098 or 601967-1	—	—	—	200893-2 or 91002-1	305183
	1-601967-5						
	1-601967-6	45098 or 601967-1	—	—	—	200893-2 or 91002-1	305183
	1-601967-6	45098 or 601967-1					
→	1-601967-6	45098 or 601967-1	—	—	—	200893-2 or 91002-1	305183
	1-601967-5						
	1-601966-0	601966-1	599406-7	1-125905-1	—	91005-2	91004-2
	1-601966-0	601966-1	599406-7	—	—	—	—
	601966-2	601966-1	599406-7	—	—	—■	—■

Figure 3 (Cont'd)

■ Military Spec MIL-I-81969/14

CONTACT					WIRE		TOOL SELECTOR SETTING
Product Line	Size	Pin	Socket	Military Spec	Size (AWG)	Strip Length	
Type XV For ARINC Front Release AM, AD, and AAP Connectors	20	203840	—	—	24	4.78 [.188]	2
					22		3
					20		4
		—	203841	—	24	4.78 [.188]	2
					22		3
					20		4
	16	203884	—	—	20	6.35 [.250]	4
					18		5
					16		5
Type XVII For ARINC Rear Release RM Connectors	22	204873	—	MIL-C-39029/11-144	26	3.96 [.156]	3
					24		3
					22		4
		—	205103	MIL-C-39029/12-148	26	3.96 [.156]	3
					24		3
					22		4
		—	205904	—	30 ^①	3.96 [.156]	4
					28		5
					26		6
	20	204938	—	MIL-C-39029/11-145	24	3.96 [.156]	5
					22		6
					20		7
		—	205116	MIL-C-39029/12-149	24	3.96 [.156]	5
					22		6
					20		7
		205791	206887	—	30 ^①	3.96 [.156]	4
					28		5
					26		6
	16	204978	—	MIL-C-39029/11-146	20	6.35 [.250]	4
					18		5
					16		6
		—	205117	MIL-C-39029/12-150	20	6.35 [.250]	4
					18		5
					16		6
12	205763-5	—	—	14	6.35 [.250]	7	
				12		8	
	—	205851-2	—	—	14	6.35 [.250]	7
—	—	—	—	12	8		

Figure 3 (Cont'd)

① This wire size is not recommended for use in the machine.

	Tooling For Loose Piece Contacts		Tooling For Tape Mounted Contacts		CONNECTOR Military Spec	INSERTION TOOL	EXTRACTION TOOL
	Positioner or Turret Head	Hand Crimping Tool	Machine	Funnel			
→	601967-2	601967-1	599406-5	125905-8	MIL-C-81659	91039-1	91040-1
	601967-2	601967-1	599406-5	125905-8	MIL-C-8165	91039-1	91040-1
	601967-2	601967-1	599406-5	125905-6	MIL-C-81659	91039-3	91040-3
	601966-8	601966-1	599406-7	1-125905-2	MIL-C-81659	91066-1	91066-1
	601966-8	601966-1	599406-7	1-125905-2	—	91066-1	91066-1
	601966-8	601966-1	599406-7	1-125905-2	—	91066-1	91066-1
→	601966-5	601966-1	599406-7	125905-1 (Max Insulation Dia 1.98 [.078])	MIL-C-81659	91067-2	91067-2
	601966-5	601966-1	599406-7	125905-1 (Max Insulation Dia 1.98 [.078])	—	91067-2	91067-2
	601966-5	601966-1	599406-7	—	—	91067-2	91067-2
	601967-2	601967-1	599406-5	125905-6	MIL-C-81659	91066-3	91066-3
	601967-2	601967-1	599406-5	125905-6	—	91066-3	91066-3
	601967-2	601967-1	—	—	MIL-C-81659	—	445147-1
	601967-2	601967-1	—	—	MIL-C-81659	—	445147-1

Figure 3 (Cont'd)

Product Line	CONTACT				WIRE		TOOL SELECTOR SETTING	
	Size	Pin	Socket	Military Spec	Size (AWG, See Note)	Strip Length		
COAXICON* Contact For ARINC Coaxial Connectors	0	—	51781-1	—	RG 214/U	—	—	
	1	225837-1	—	—	Semi-Rigid 141	② (408-2348-02)	8	
		—	225831-1	—	—	RG 214/U	② (408-2348-02)	—
	3	226053-1	—	—	RG 141/U, 58C/U	② (408-2348-01)	8	
		—	225792-1	—	RG 214/U, 213/U	② (408-2348-01)	—	
		—	225792-3	—	RG 58C/U, 141A/U	② (408-2348-01)	8	
	5	225790-1	225791-1	—	RG 58C/U, 141/U	② (408-2348)	5	
		225790-2	225791-2	—	RG 233/U, 142/U	② (408-2348)	5	
		225790-3	—	—	Semi-Rigid 141	② (408-2348)	5	
		225790-4	—	—	RG 180B/U	② (408-2348)	5	
	7	—	225796-1	—	RG 58C/U	② (408-2348-01)	5	
		—	225796-2	—	RG 233/U		5	
	9	225935-1	—	—	RG 58C/U, 141A/U	② (408-2348-03)	5	
		—	225936-1	—	Semi-Rigid 141	② (408-2348-03)	5	
	ARINC 600	22	208262	—	—	26	3.96 [.156]	3
						24		3
						22		4
		—	208264	—	—	—	26	3.96 [.156]
24							3	
22							4	
20		208265	—	—	—	24	3.96 [.156]	5
						22		6
						20		7
—		208267	—	—	—	24	3.96 [.156]	5
						22		6
						20		7

Figure 3 (Cont'd)

② Refer to the instruction sheet (408-series) packaged with the contact for wire strip length.

Note: Unless otherwise specified

→	Tooling for Loose Piece Contacts		Tooling for Tape Mounted Contacts		CONNECTOR Military Spec	INSERTION TOOL	EXTRACTION TOOL
	Positioner or Turret Head	Hand Crimping Tool	Machine	Funnel			
	—	69646	—	—	—	—	91040-7
	—	601966-1 ^④ and 220066-1 ^⑤	—	—	—	—	—
	—	220015-1	—	—	—	—	—
	1-601966-8 ^③	601966-1 ^④ and 220066-1 ^⑤	—	—	—	—	—
	—	220015-1	—	—	—	—	—
	—	601966-1 ^④ and 220066-1 ^⑤	—	—	—	—	—
	1-601966-6 ^③	601966-1 ^④ and 220066-1 ^⑤	—	—	—	—	91074-1
	1-601966-6 ^③	601966-1 ^④ and 220066-1 ^⑤	—	—	—	—	91074-1
	1-601966-6 ^③	601966-1 ^④ and 220066-1 ^⑤	—	—	—	—	91074-1
	1-601966-6 ^③	601966-1 ^④ and 220066-1 ^⑤	—	—	—	—	91074-1
	2-601966-6 ^③	601966-1 ^④ and 220066-1 ^⑤	—	—	—	—	—
→	1-601966-6 ^③	601966-1 ^④ and 220066-1 ^⑤	—	—	—	—	—
	1-601966-6 ^③	601966-1 ^④ and 220066-1 ^⑤	—	—	—	—	91074-1
	1-601966-6 ^③	601966-1 ^④ and 220066-1 ^⑤	—	—	—	—	91074-1
	601966-8	601966-1	599406-7	1-125905-2	—	91066-1	91066-1
	601966-8	601966-1	599406-7	1-125905-2	—	91066-1	91066-1
	601966-5	601966-1	599406-7	125905-1	—	91067-2	91067-2
	601966-5	601966-1	599406-7	125905-1 (Max Insulation Dia 1.98 [.078])	—	91067-2	91067-2

Figure 3 (Cont'd)

③ This positioner is used with Tool 601966-1

④ This tool crimps only the center contact of the pin or socket

⑤ This tool crimps only the ferrule of the pin or socket

Product Line	Size	CONTACT			WIRE		TOOL SELECTOR SETTING	
		Pin	Socket	Military Spec	Size (AWG, See Note)	Strip Length		
ARINC 600	16	204978	—	—	20	6.35 [.250]	4	
		208268	—	—	18		5	
		213122	—	—	16		6	
		—	208270	—	—	20	6.35 [.250]	4
						18		5
						16		6
	12	208271	—	—	14	6.35 [.250]	7	
		213123	—	—	12		8	
		—	208273	—	—	14	6.35 [.250]	7
12						8		
TRIAxIAL	8	222190	222191	MIL-C-39029-95 and MIL-C-39029-96	—	—	—	
Type XVII For AMPLIMITE* HDD Connectors	22D	206496	—	—	28	3.96 [.156]	3	
					26		4	
		—	206496	—	—	28	3.96 [.156]	3
						26		4
		204370	—	—	MIL-C-39029/58-360	28	3.96 [.156]	1
						26		2
						24		3
						22		4
		—	204351	—	MIL-C-39029/57-354	28	3.96 [.156]	1
						26		2
						24		3
						22		4
	—	206071	—	—	28	3.96 [.156]	1	
					26		2	
					24		3	
					22		4	
	20	206794	206795	—	28	3.96 [.156]	5	
					26		6	
		205089	—	—	MIL-C-39029/64-369	24	3.56 [.140]	5
						22		6
20						7		

Figure 3 (Cont'd)

Note: Unless otherwise specified

	Tooling for Loose Piece Contacts		Tooling for Tape Mounted Contacts		CONNECTOR Military Spec	INSERTION TOOL	EXTRACTION TOOL
	Positioner or Turret Head	Hand Crimping Tool	Machine	Funnel			
→	601967-2	601967-1	599406-5	125905-6	—	91066-3	91066-3
	601967-2	601967-1	599406-5	125905-6	—	91066-3	91066-3
	1-601967-2	601967-1	—	—	—	—	445147-1
	1-601967-2	601967-1	—	—	—	—	445147-1
	—	608650-1	—	—	MIL-C-83527	—	58284-1
	601966-6	601966-1	599406-7	125905-2	—	91067-1	91067-1
	601966-4	601966-1	599406-7	125905-2	—	91067-1	91067-1
→	601966-6	601966-1	599406-7	125905-2	MIL-C-24308	91067-1	91067-1
	601966-4	601966-1	599406-7	125905-2	MIL-C-24308	91067-1	91067-1
	601966-4	601966-1	599406-7	125905-2	—	91067-1	91067-1
	601966-5	601966-1	599406-7	—	—	91067-2	91067-2
	601966-5	601966-1	599406-7	125905-1	MIL-C-24308	91067-2	91067-2

Figure 3 (Cont'd)

CONTACT					WIRE		TOOL SELECTOR SETTING
Product Line	SIZE	Pin	Socket	Military Spec	Size (AWG)	Strip Length	
Type XVII For AMPLIMITE HDD Connectors	20	—	205090	MIL-C-39029/63-368	24	3.56 [.140]	5
					22		6
					20		7
		1218266-1	1218267-1	—	18 ^⑥	3.56 [.140]	7
					18 ^⑥		7
					24		5
		—	206793	—	22	3.56 [.140]	6
					20		7
					24		5
AMPLIMITE Power 8 Contact	8	211159-1	211161-1	—	8	9.53 [.375]	7
		211159-2	211161-2	—	10		6
		212007-1	212008-1	—	12	9.53 [.375]	1
					14		1
		212013-1	212014-1	—	16	9.53 [.375]	8
					18		6
		213552	—	—	8	9.53 [.375]	7
					10		6
		LGH* Contact	22	—	204351-1	MIL-C-39029/57-354	28
26	2						
24	3						
22	4						
861211 or 863260	—			—	28	3.18 [.125]	4
					26		5
					24	3.96 [.156]	5
					22		6
—	867782		—	—	24	3.96 [.156]	5
					22		6
					20	6.35 [.250]	7
16	—		867328	MIL-C-39029/12-150	20	6.35 [.250]	4
					18		5
					16		6
	—		861080	—	—	22 (2) ^⑦	4.78 [.188]
		16				7	

Figure 3 (Cont'd)

⑥ 19-strand wire

⑦ Use two size 22 AWG wires

	Tooling for Loose Piece Contacts		Tooling for Tape Mounted Contacts		CONNECTOR Military Spec	INSERTION TOOL	EXTRACTION TOOL
	Positioner or Turret Head	Hand Crimping Tool	Machine	Funnel			
→	601966-5	601966-1	599406-7	125905-1	—	91067-2	91067-2
	601966-5	601966-1	—	—	—	91067-2	91067-2
	601966-5	601966-1	599406-7	125905-1	—	91067-2	91067-2
	608651-2	608651-1	—	—	—	—	318813-1
	608651-2	608651-1	—	—	—	—	318813-1
	608668-2	608668-1	—	—	—	—	318813-1
	608651-3	608651-1	—	—	—	—	318813-1
→	601966-4	601966-1	—	—	—	—	—
	—	601966-1	—	—	—	—	—
	—	601966-1	—	—	—	—	—
	601967-2	601967-1	—	—	—	91067-1	91067-1
	—■	601967-1	—	—	—	91066-3	91066-3

Figure 3 (End)

■ Military Spec MIL-C-22520/1-05

3. TOOLING ASSEMBLY

3.1. Installing Positioner

Refer to Figure 4, and proceed as follows:

1. Squeeze the tool handles together, then allow the handles to FULLY open.

CAUTION  The tool handles must be fully opened when installing the positioner; otherwise, damage to the tool will occur.

2. Insert the post of the positioner into the hole in the back of the tool. Make sure that the bayonet pin enters the slot in the retainer ring of the tool.

Installing Positioner

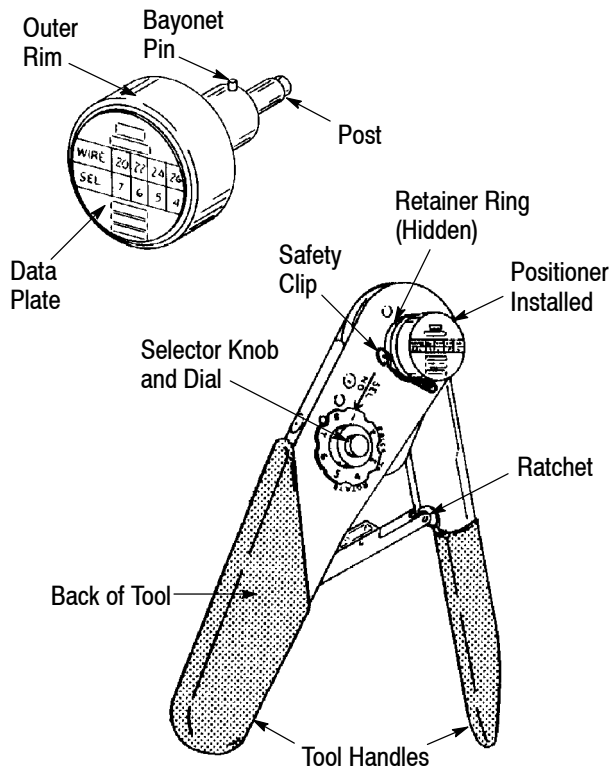



Figure 4

3. Firmly grip the outer rim of the positioner and push until the spring inside the positioner is depressed, then rotate the positioner *clockwise* until it stops.
4. Insert the tool safety clip into the retainer ring to lock the positioner in place.
5. Determine the selector setting according to the contact size and wire size listed in Figure 3 (or

refer to the data plate on the positioner. Pull the selector knob and turn to the proper setting.

CAUTION  The tool handles must be fully opened when changing the positioner selector setting; otherwise, damage to the tool will occur.

3.2. Installing Turret Head

Refer to Figure 5, and proceed as follows:

1. Squeeze the tool handles together, then allow the handles to FULLY open.

CAUTION  The tool handles must be fully opened when installing the positioner; otherwise, damage to the tool will occur.

2. Depress the turret trigger to release the turret from the index position (the turret should be extended).

Installing Turret Head

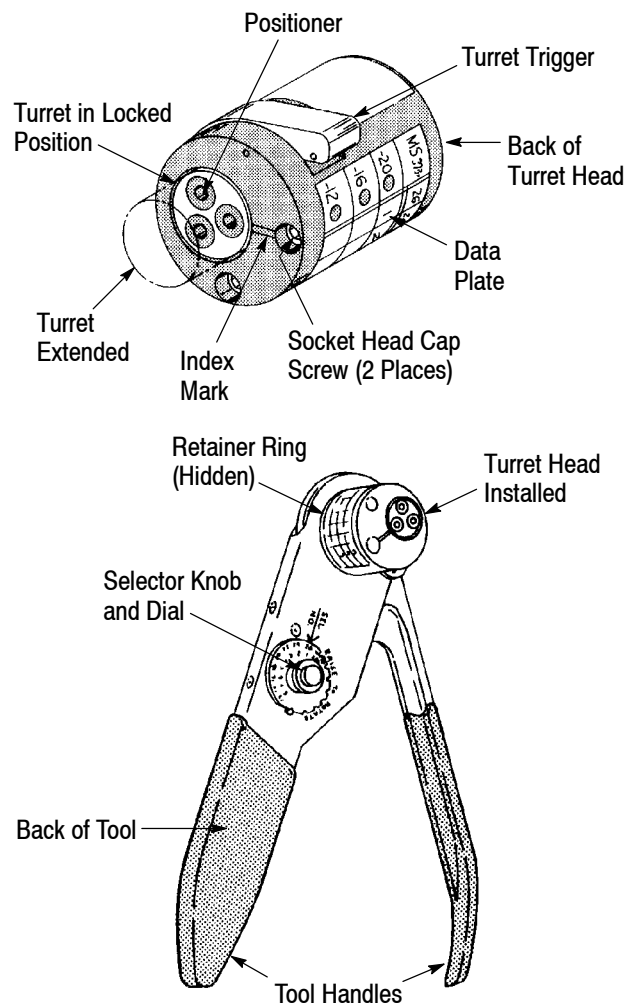

Figure 5

3. Place the back of the turret head over the retainer ring on the back of the tool. Make sure that the turret head is seated, then tighten the two socket head cap screws of the turret head.
4. Rotate the turret until the positioner marked with the desired contact size is aligned with the index mark.
5. Press the turret until it is in the locked position.
6. Determine the selector setting according to the contact size and wire size listed in Figure 3. Pull the selector knob and turn to the proper setting.



The tool handles must be fully opened when changing the positioner selector setting; otherwise, damage to the tool will occur.

4. CRIMPING PROCEDURE

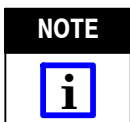

These tools have a ratchet which ensures proper crimping of the contacts. Once engaged, the ratchet will NOT release until the tool handles are FULLY closed.

1. Strip the wire according to the wire size listed in Figure 3.
2. Squeeze the tool handles together, then allow the handles to FULLY open.
3. Insert the mating end of the contact into the indenter from the FRONT of the tool until the contact bottoms. Refer to Figure 6.

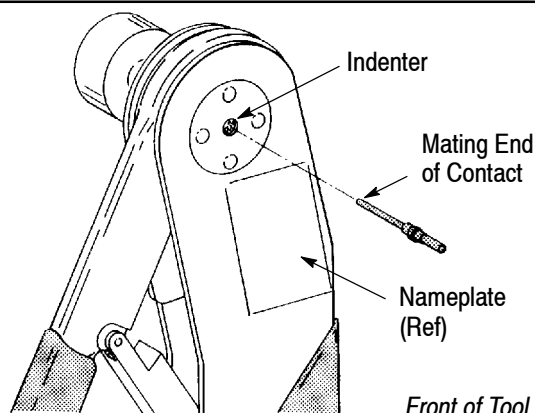

Figure 6

4. Insert the wire into the contact wire barrel. While holding the wire in place, squeeze the tool handles until the ratchet releases. Allow the handles to open.
5. Remove the crimped contact from the tool. Inspect the contact according to the applicable application specification (114-series).

5. MAINTENANCE AND INSPECTION

5.1. Daily Maintenance

Each operator should be aware of, and responsible for, the following steps of daily maintenance, to ensure continuous quality and reliability of each tool.

1. Remove dust, moisture, and other contaminants with a clean brush, or soft, lint-free cloth. DO NOT use objects that could damage the tool.
2. When the tool is not in use, keep the handles closed, and store the tool in a clean, dry area.

5.2. Gaging the Die Opening (Indenters)

This inspection requires the use of a plug gage conforming to the dimensions provided in Figure 7. For plug gages used for periodic general inspection, see Figure 8. To gage the die opening, proceed as follows:

1. Remove traces of oil or dirt from the die opening and plug gage.
2. Fully close tool handles; then hold in this position. DO NOT force beyond initial contact.
3. Insert GO element into the die opening; but do not force it. The GO element must pass through the length of the die opening. See Figure 9.
4. In the same manner, try to insert the NO-GO element into the die opening. The NO-GO element may enter partially, but must not pass completely through the length of the die opening. See Figure 9.



Be careful NOT to crimp the gage element.

If the die opening conforms to the gage inspection, the tool may be considered dimensionally correct and should be lubricated with a THIN coat of any good SAE 20 motor oil. If the die opening does NOT conform to the gage inspection, the tool must be returned for further evaluation and repair.

For additional information regarding the use of a plug gage, refer to 408-7424.

5.3. Crimp Height Inspection

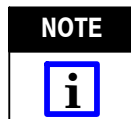

Allowances for tool stresses and relaxation of contact material were calculated into the crimp height measurements for military specified contacts only.

This inspection requires the use of a micrometer, or equivalent, as shown in Figure 10. It is recommended using the micrometer (Dial Micrometer 27-9) which may be purchased from:

B.C. Ames Company
Lexington Street
Waltham, MA 02154

Suggested Plug Gage Design

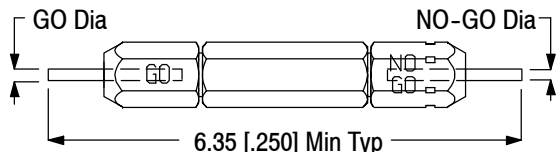

TOOL (Military Spec)	TOOL SELECTOR SETTING	GAGE ELEMENT DIAMETER ± 0.003 [.0001]	
		GO	NO-GO
601966-1 (MIL-C-22520/2-01)	1	0.33 [.013]	0.46 [.018]
	2	0.41 [.016]	0.53 [.021]
	3	0.48 [.019]	0.61 [.024]
	4	0.56 [.022]	0.69 [.027]
	5	0.66 [.026]	0.79 [.031]
	6	0.76 [.030]	0.89 [.035]
	7	0.86 [.034]	0.99 [.039]
	8•	0.99 [.039]•	1.12 [.044]•
608651-1	1	1.78 [.070]	2.03 [.080]
	2	1.91 [.075]	2.16 [.085]
	3	2.03 [.080]	2.29 [.090]
	4•	2.16 [.085]•	2.41 [.095]•
	5	2.34 [.092]	2.59 [.102]
	6	2.51 [.099]	2.77 [.109]
	7	2.74 [.108]	3.00 [.118]
	8	3.00 [.118]	3.25 [.128]
601967-1 (MIL-C-22520/1-01) and 608668-1	1	0.71 [.028]	0.84 [.033]
	2	0.81 [.032]	0.94 [.037]
	3	0.91 [.036]	1.04 [.041]
	4•	0.99 [.039]•	1.12 [.044]•
	5	1.14 [.045]	1.27 [.050]
	6	1.32 [.052]	1.45 [.057]
	7	1.50 [.059]	1.63 [.064]
	8	1.73 [.068]	1.85 [.073]

• Use for periodic general inspection. The plug gages listed in Figure 8 conform to these gage element diameters.

Figure 7

For Periodic General Inspection

TOOL	TOOL SELECTOR SETTING	PLUG GAGE (Military Spec)
601966-1	8	601968-1 (MIL-C-22520/3-01)
601967-1	4	
608668-1	4	
608651-1	4	601968-3

Figure 8

Gaging the Die Opening

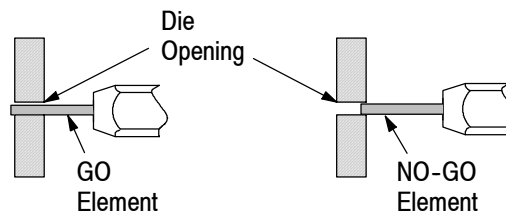

GO element must pass completely through the die opening.

NO-GO element may enter partially, but must not pass completely through the die opening.

Figure 9

To inspect the crimp height, proceed as follows:

1. Crimp the contact according to Section 3, CRIMPING PROCEDURE.
2. Measure across opposite indents in the contact, then rotate the contact 90 degrees, and measure again. See Figure 10. DO NOT go beyond initial contact as this could cause a depression and result in an inaccurate reading.

Crimp Height Inspection

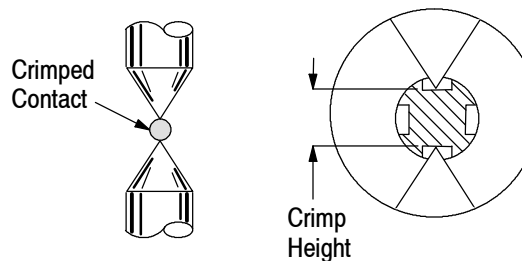

TOOL SELECTOR SETTING	CRIMP HEIGHT	
	TOOL 601966-1 Military Spec MIL-C-22520/2-01	TOOL 601967-1 Military Spec MIL-C-22520/1-01
1	0.406-0.533 [.016-.021]	0.813-0.940 [.032-.037]
2	0.483-0.610 [.019-.024]	0.914-1.041 [.036-.041]
3	0.559-0.686 [.022-.027]	1.016-1.143 [.040-.045]
4	0.635-0.762 [.025-.030]	1.092-1.219 [.043-.048]
5	0.737-0.864 [.029-.034]	1.245-1.372 [.049-.054]
6	0.838-0.965 [.033-.038]	1.422-1.549 [.056-.061]
7	0.940-1.067 [.037-.042]	1.600-1.727 [.063-.068]
8	1.067-1.194 [.042-.047]	1.829-1.956 [.072-.077]

Figure 10

3. Check the height of the crimped contact against the crimp height dimensions shown in Figure 10. If the crimp height conforms to that shown, the tool is considered dimensionally correct. Lubricate the tool with a thin coat of any good SAE 20 motor oil and return it to service.

6. REPLACEMENT AND REPAIR

Order replacement parts through your TE Representative, or call 1-800-526-5142, or send a facsimile of your purchase order to 717-986-7605, or write to:

CUSTOMER SERVICE (038-035)
TYCO ELECTRONICS CORPORATION
PO BOX 3608
HARRISBURG PA 17105-3608

For customer repair service, contact a TE Representative at 1-800-526-5136.

7. REVISION SUMMARY

- Updated document to corporate requirements.