

NOTE:

1. HOUSING WILL ACCEPT CONTACT P/N 92007-1.
2. PRODUCT SPEC: 108-51007
3. APPLICATION SPEC: 114-58000

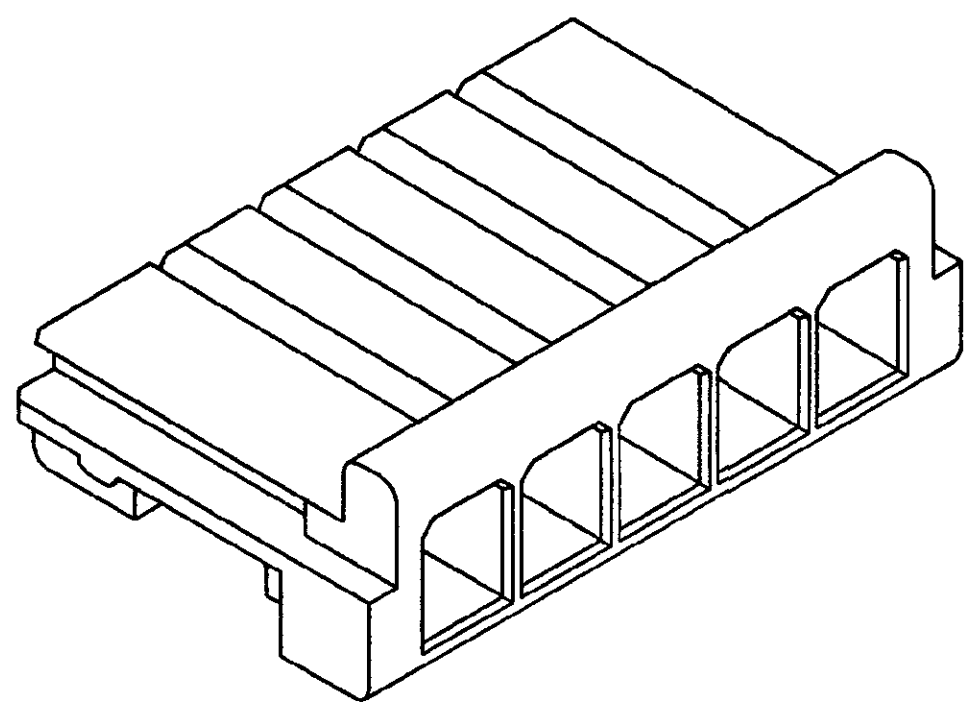
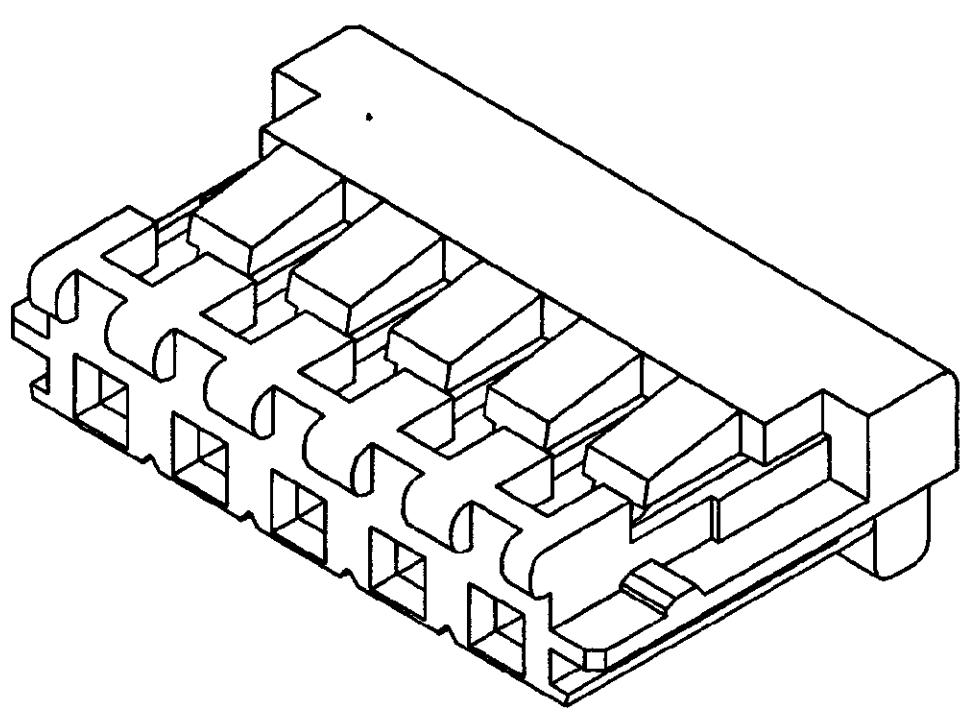
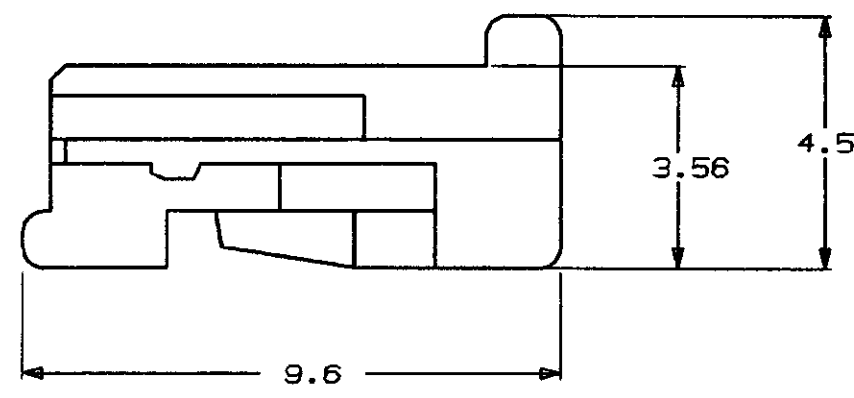
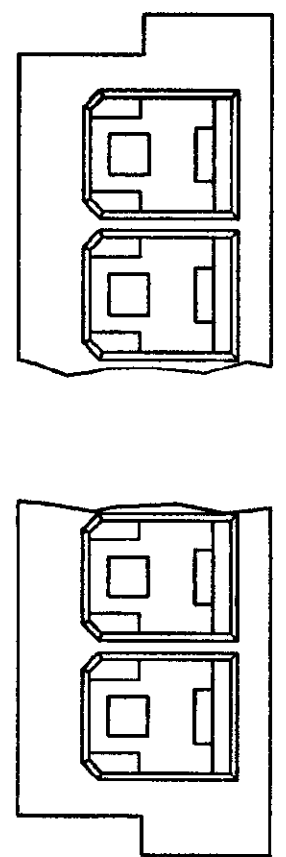
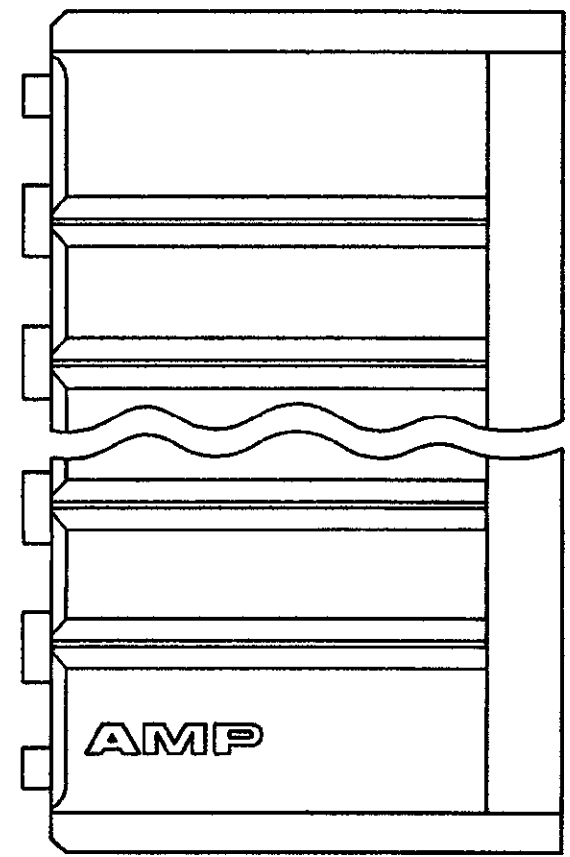
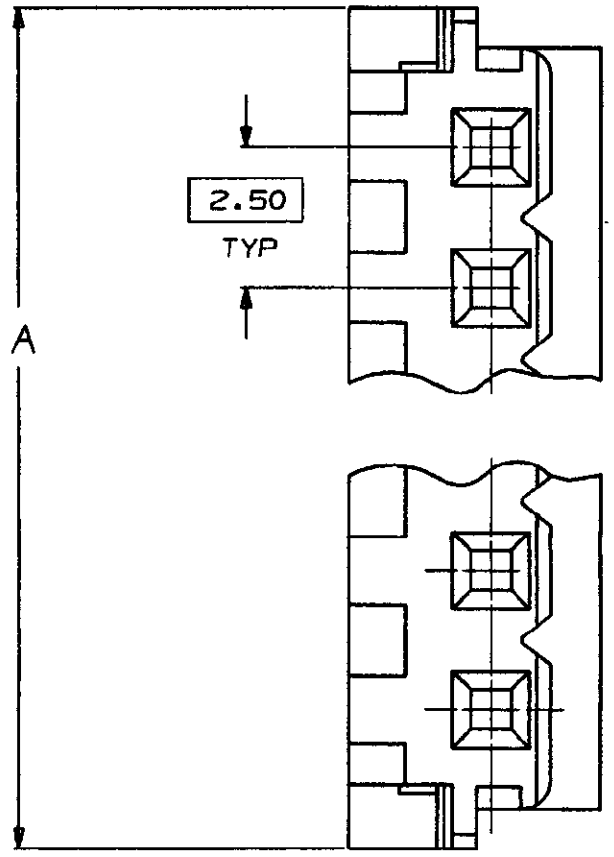
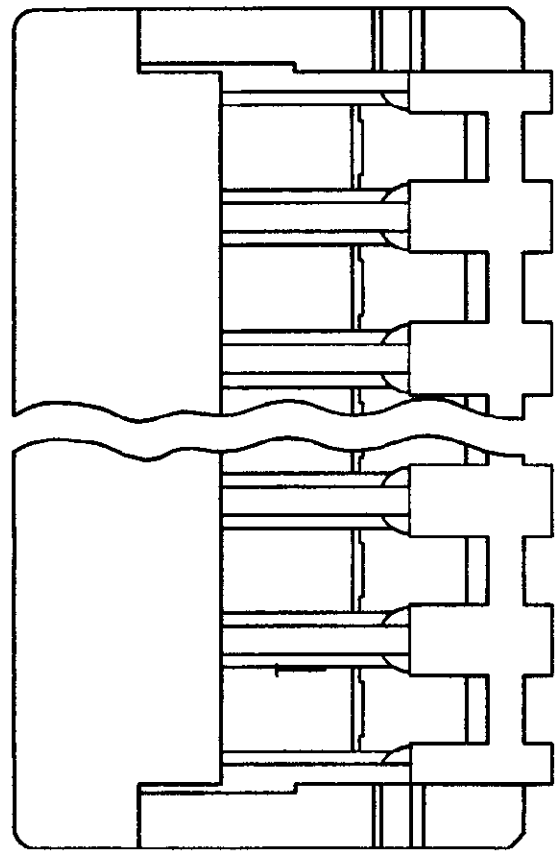

THREE DIMENSIONAL MODEL  
 NOT TO SCALE

40	15	9-92009-5	7-92009-5	5-92009-5	3-92009-5	1-92009-5
37.5	14	9-92009-4	7-92009-4	5-92009-4	3-92009-4	1-92009-4
35	13	9-92009-3	7-92009-3	5-92009-3	3-92009-3	1-92009-3
32.5	12	9-92009-2	7-92009-2	5-92009-2	3-92009-2	1-92009-2
30	11	9-92009-1	7-92009-1	5-92009-1	3-92009-1	1-92009-1
27.5	10	9-92009-0	7-92009-0	5-92009-0	3-92009-0	1-92009-0
25	9	8-92009-9	6-92009-9	4-92009-9	2-92009-9	92009-9
22.5	8	8-92009-8	6-92009-8	4-92009-8	2-92009-8	92009-8
20	7	8-92009-7	6-92009-7	4-92009-7	2-92009-7	92009-7
17.5	6	8-92009-6	6-92009-6	4-92009-6	2-92009-6	92009-6
15	5	8-92009-5	6-92009-5	4-92009-5	2-92009-5	92009-5
12.5	4	8-92009-4	6-92009-4	4-92009-4	2-92009-4	92009-4
10	3	8-92009-3	6-92009-3	4-92009-3	2-92009-3	92009-3
7.5	2	8-92009-2	6-92009-2	4-92009-2	2-92009-2	92009-2
A	NO OF CIRCUITS	BLUE	BLACK	RED	YELLOW	NATURAL

PART NO



C1 REVISED PER ECO-11-005294		RK	HMR	SAPR11	DR. D. MARFOE	DE.	NYLON UL94V-0 (WHITE)		HOUSING, CRIMP-SNAP, METRIC INTERCONNECT SYSTEM		92009	
LTR	(REVISION RECORD)	DR	CHK	DATE	CHK.	APP.	GENERAL TOLERANCE	SIZE	LOC	ING.	SCALE	SHEET
							2 PLC DEC ±0.13	A2	DY		8:1	1 of 1
							3 PLC DEC ±.1					
							ANGLES ±.1					