

3D VIEW

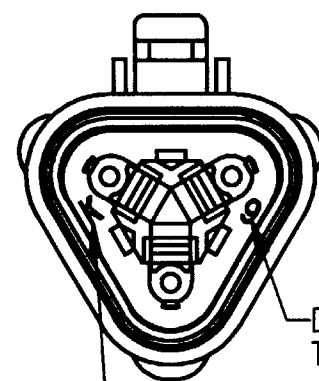

DATE CODE: EXAMPLE OF THE YEAR 1999

DATE CODE: EXAMPLE OF THE MONTH OF NOVEMBER

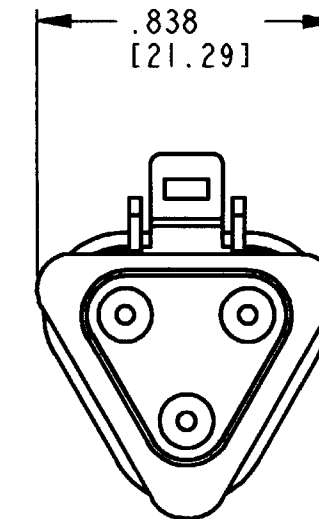
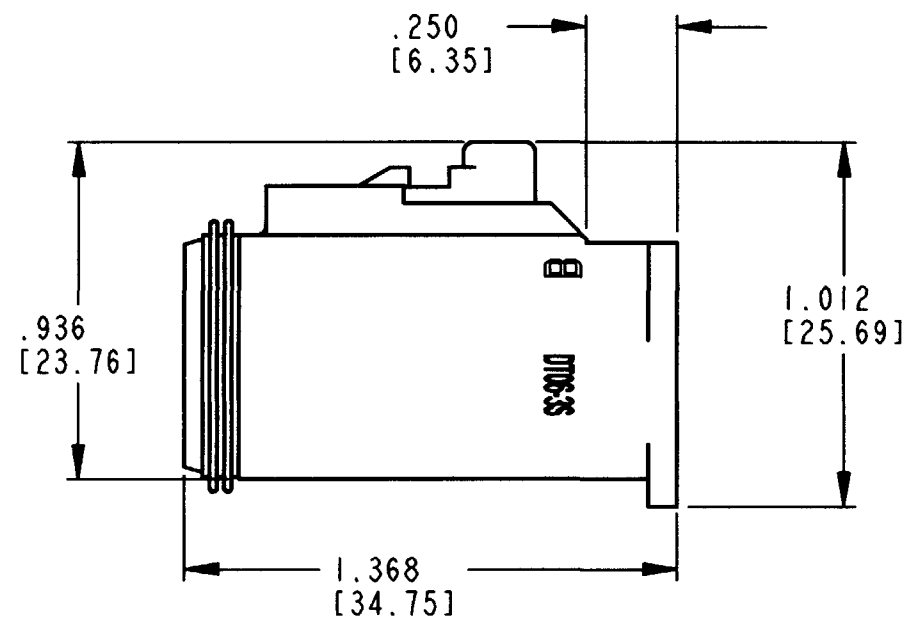

REV
NC DT06-3S-P032

REVISIONS			
SYM	DESCRIPTION	DATE	APPROVED
NC	NEW RELEASE PER E.O.PI6337	10-15-99	RDR

- NOTES:
1. DIMENSIONS ARE IN INCHES [MILLIMETERS].
 2. DIMENSIONS ARE $\pm .025$ [0.63] UNLESS OTHERWISE SPECIFIED.
 3. FOR CONTACTS AND WIRE PERFORMANCE AND APPLICATION CHARACTERISTICS SEE ENVELOPE DRAWING 0425-015-0000 AND 0425-017-0000.
 4. THIS PLUG MATES WITH DT04-3P-**** RECEPTACLE(**** = ALL MODIFICATIONS). CONSULT FACTORY FOR MODIFICATIONS.

SIGNATURE & DATE	
DR	S. THEIS 11/5/98
CHK	<i>[Signature]</i> 15/10/99
PE	<i>[Signature]</i> 10-15-99
APPD	<i>[Signature]</i> 10-15-99
SCALE	2:1 WT

3 WAY PLUG
P032 MOD
INTEGRATED ADAPTER
SHRINK BOOT
DT SERIES
ENVELOPE

CP	MATL. CODE
The Deutch Company	
DEUTSCH I.P.D. 3850 INDUSTRIAL AVE. HEMET, CALIF. 92545	
B	DT06-3S-P032
DWG SIZE	CODE 11139 SHEET OF