

Fiber Optic Detector

OPF472



Features:

- High speed, low capacitance
- Popular ST[®] style receptacle
- Pre-tested with fiber to assure performance
- Component pre-mounted and ready to use
- 35MHz operation minimum

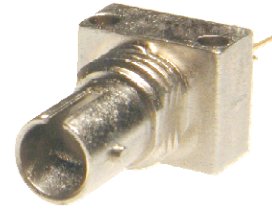

Description:

The OPF472 is a low noise silicon PIN photodiode mounted in a low cost package for fiber optic applications. It offers fast response at moderate bias and is compatible with LED and laser diode sources in the 800-1000 nm wavelength region. Low capacitance improves signal to noise performance in typical short haul LAN applications.

The OPF472 is designed to be compatible with multimode optical fibers from 50/125 to 200/300 microns.

Applications:

- Industrial Ethernet equipment
- Copper –to-fiber media conversion
- Intra-system fiber optic links
- Video surveillance systems

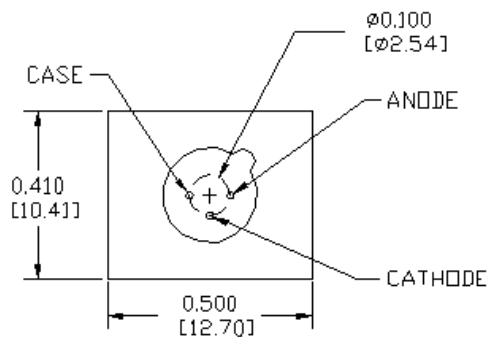
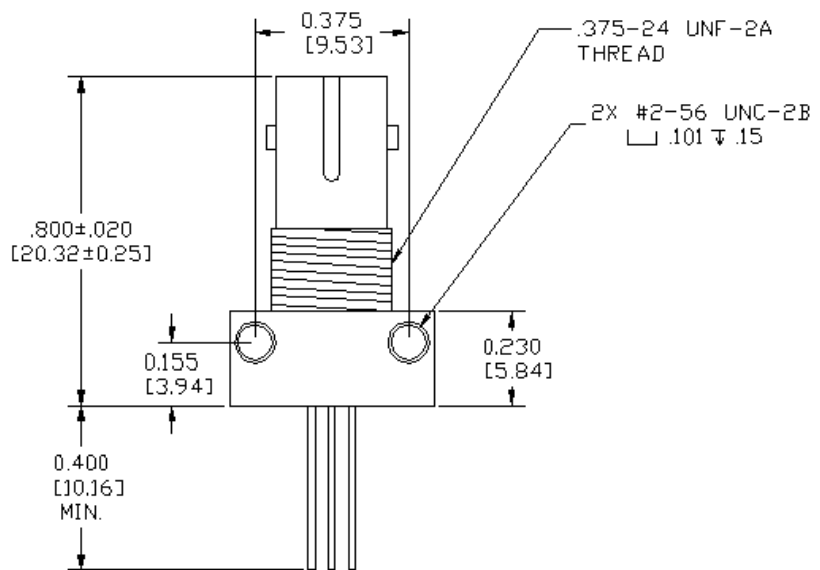

DIMENSIONS ARE IN: [MILLIMETERS] INCHES



RoHS

ST[®] is a registered trademark of AT&T.

General Note
TT Electronics reserves the right to make changes in product specification without notice or liability. All information is subject to TT Electronics' own data and is considered accurate at time of going to print.

OPTEK Technology, Inc.
1645 Wallace Drive, Carrollton, TX 75006 | Ph: +1 972 323 2200
www.optekinc.com | www.ttelectronics.com

Electrical Specifications

Absolute Maximum Ratings ($T_A = 25^\circ\text{C}$ unless otherwise noted)	
Storage Temperature Range	-55° C to +100° C
Operating Temperature Range	-40° C to +85° C
Lead Soldering Temperature ⁽¹⁾	260° C
Continuous Power Dissipation ⁽²⁾	200 mW
Maximum Reverse Voltage	100 VDC

Electrical Characteristics ($T_A = 25^\circ\text{C}$ unless otherwise noted)						
SYMBOL	PARAMETER	MIN	TYP	MAX	UNITS	TEST CONDITIONS
R	Responsivity	0.45	0.55		A/W	$V_R = 5.0\text{V}$; 50/125 μm fiber; $\lambda = 850\text{nm}$
I_D	Dark Current		0.1	5.0	nA	$V_R = 5.0\text{V}$
λ_p	Peak Response Wavelength		905		nm	
t_r	Output Rise Time		6.0		ns	$V_R = 15\text{V}$; $R_L = 50\Omega$, 10%-90%
C_T	Total Capacitance		3.0		pF	$V_R = 20\text{V}$

Notes:

1. Maximum of 5 seconds with soldering iron. Duration can be extended to 10 seconds when flow soldering. RMA flux is recommended.
2. De-rate linearly at 2.67mW/°C above 25°C .

Performance

Typical Responsivity

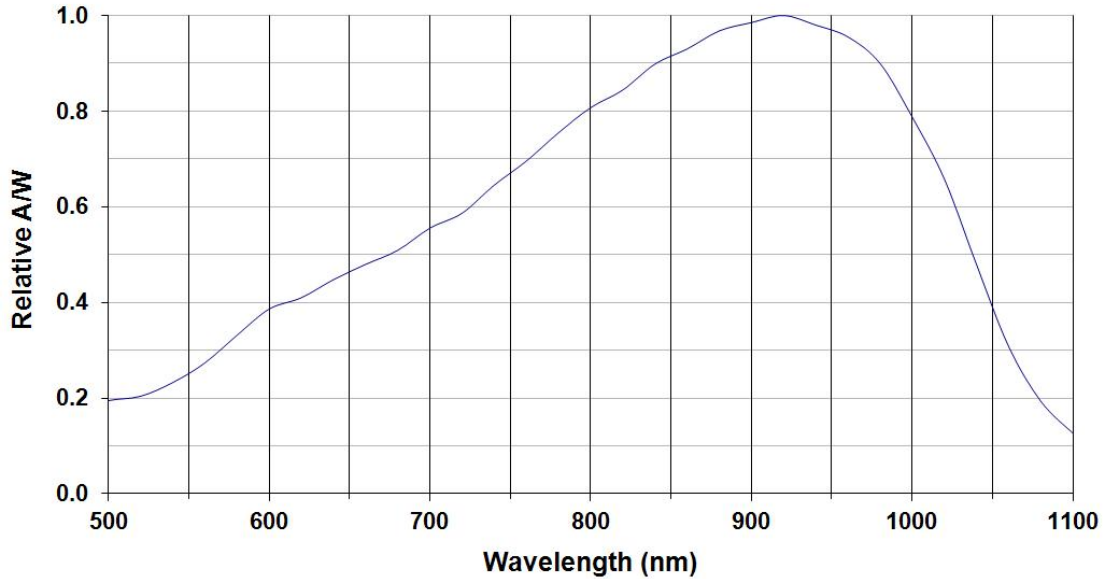

Dark Current vs. Temperature

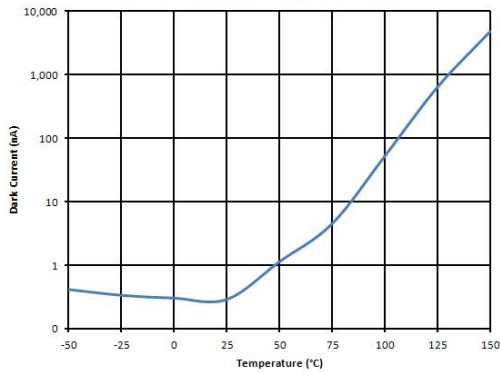

Rise Time vs. Bias Voltage

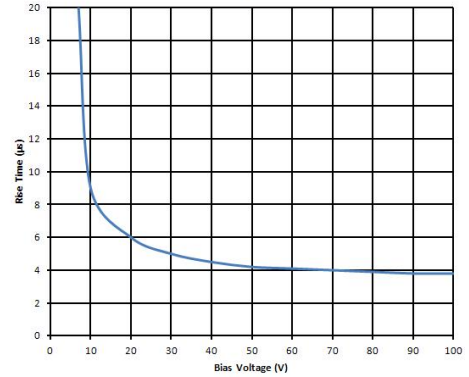

Dark Current vs. Bias Voltage

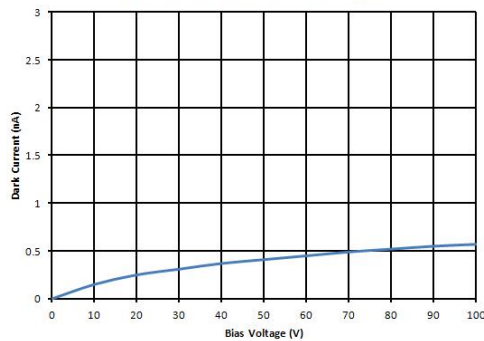

Capacitance vs. Bias Voltage

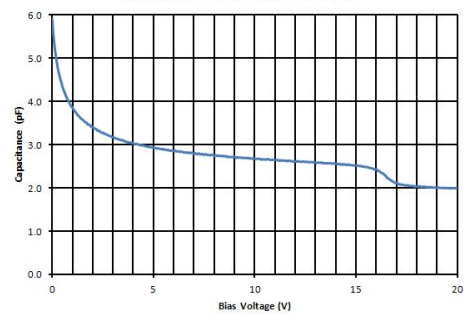

General Note
TT Electronics reserves the right to make changes in product specification without notice or liability. All information is subject to TT Electronics' own data and is considered accurate at time of going to print.

OPTEK Technology, Inc.
1645 Wallace Drive, Carrollton, TX 75006 | Ph: +1 972 323 2200
www.optekinc.com | www.ttelectronics.com