



Features

- > Resistance welded type crystal units.
- > A great number of standard frequencies.
- > Higher frequency pullability and lower equivalent series resistance.
- > Lower cost and highly mass production capability.
- > The best choice of TV, STB, LCDM and Cable Modem.
- > RoHS Compliant / Pb Free

Electrical Specifications

Item / Type	9B
Frequency Range	3.2 ~ 90 MHz
Frequency Tolerance (at 25 °C)	± 10 ppm, or specify
Frequency Stability Over Operating Temperature Range	± 10 ppm (- 20 ~ +70 °C), or specify
Operating Temperature Range	- 20 ~ +70 °C
Shunt Capacitance (C0)	7 pF Max.
Drive Level	1 ~ 500 μW (100 μW typical)
Load Capacitance	18 pF, or specify
Aging (at 25 °C)	± 3 ppm / year Max.
Storage Temperature Range	- 40 ~ + 85 °C

Equivalent Series Resistance(ESR)

Fundamental		3rd Overtone	
3.2 ~ 3.686 MHz	200 Ω Max.	27 ~ 30 MHz	100 Ω Max.
3.686 ~ 5 MHz	150 Ω Max.	30 ~ 50 MHz	80 Ω Max.
5 ~ 10 MHz	80 Ω Max.	50 ~ 90 MHz	60 Ω Max.
10 ~ 14 MHz	40 Ω Max.		
14 ~ 30 MHz	30 Ω Max.		

Dimensions

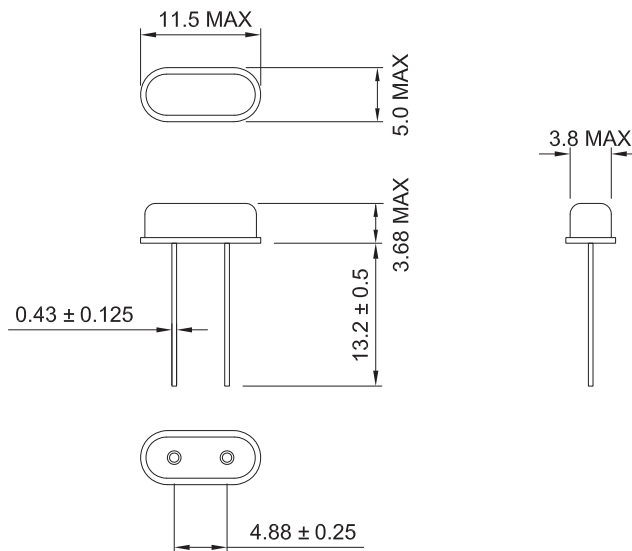

Units:mm

Remark : Specification subject to change without prior notice. Please confirm with our sales.