

RF Power Pot Capacitors with Mounting Tags or Screw Terminals, Class 1 Ceramic



QUICK REFERENCE DATA		
DESCRIPTION	VALUE	
Ceramic Class	1	
Ceramic Dielectric	R7, R16, R42, R85	
Type	TA 030090 TB 030090 TC 030090 TD 030090 TDZ 030090 TE 030090	
Voltage (V_p)	9000	10 000
Min. Capacitance (pF)	1200	50
Max. Capacitance (pF)	1600	1000
Mounting	Screw terminal	

MATERIAL

Capacitor elements made from class 1 ceramic dielectric with noble metal electrodes.

Connection terminals:
made from copper / brass, silver plated.

FINISH

Capacitor body completely protective lacquered.
The contoured insulating rim is additionally glazed.

MARKING

Type designator, capacitance value and tolerance, rated peak voltage, ceramic material code, production date code, manufacturer logo

FEATURES

- High reliability
- Multiple terminals
- Wide range of capacitance values

APPLICATIONS

- Induction and dielectric heating
- Antenna units
- Filter, bypass, and coupling circuits

CAPACITANCE RANGE

50 pF to 1.6 nF

CAPACITANCE TOLERANCE

± 20 %; ± 10 %; ± 5 %

CERAMIC DIELECTRICS

- R7 (TCC + 100 ppm/K)
- R16 (TCC + 100 ppm/K)
- R42 (TCC - 250 ppm/K)
- R85 (TCC - 750 ppm/K)

RATED VOLTAGE

- 9.0 kV_p
- 10.0 kV_p

DIELECTRIC STRENGTH TEST

200 % of rated AC voltage (50 Hz, 5 minutes)

DISSIPATION FACTOR

R7: max. 0.07 %
 R16: max. 0.04 %
 R42, R85: max. 0.05 %

Measuring frequencies:
 1 MHz (< 1 nF); 300 kHz or 100 kHz (≥ 1 nF)

INSULATION RESISTANCE

Min. 100 000 MΩ (at 25 °C)

OPERATING TEMPERATURE RANGE

-55 °C to +100 °C

SAP PART NUMBER AND ELECTRICAL DATA						
PART NUMBER	CERAMIC	CAP. VALUES (pF)	RATED VOLTAGE (kV _p)	RATED POWER ⁽¹⁾ (kvar)	RATED CURRENT (A _{RMS})	
T#030090BH500##BF1	R7	50	10	14	9.0	
T#030090BH600##BF1		60				
T#030090BH800##BF1		80				
T#030090BH101##BG1	R16	100				
T#030090BH121##BG1		120				
T#030090BH161##BG1		160				
T#030090BH201##BH1	R42	200				
T#030090BH251##BH1		250				
T#030090BH301##BH1		300				
T#030090BH401##BH1		400				
T#030090BH501##BJ1	R85	500		9.0		18
T#030090BH601##BJ1		600				
T#030090BH801##BJ1		800				
T#030090BH102##BJ1		1000				
T#030090WC122##BJ1		1200				
T#030090WC162##BJ1		1600				

Notes

- # 2nd digit: code letter of the terminal version A, B, C, D, E (exception: TDZ30090)
- ## 14th to 15th digit: capacitance tolerance code $\pm 20\%$ = 38, $\pm 10\%$ = 36, $\pm 5\%$ = 33
- ⁽¹⁾ The surface temperature during operation must not exceed +100 °C

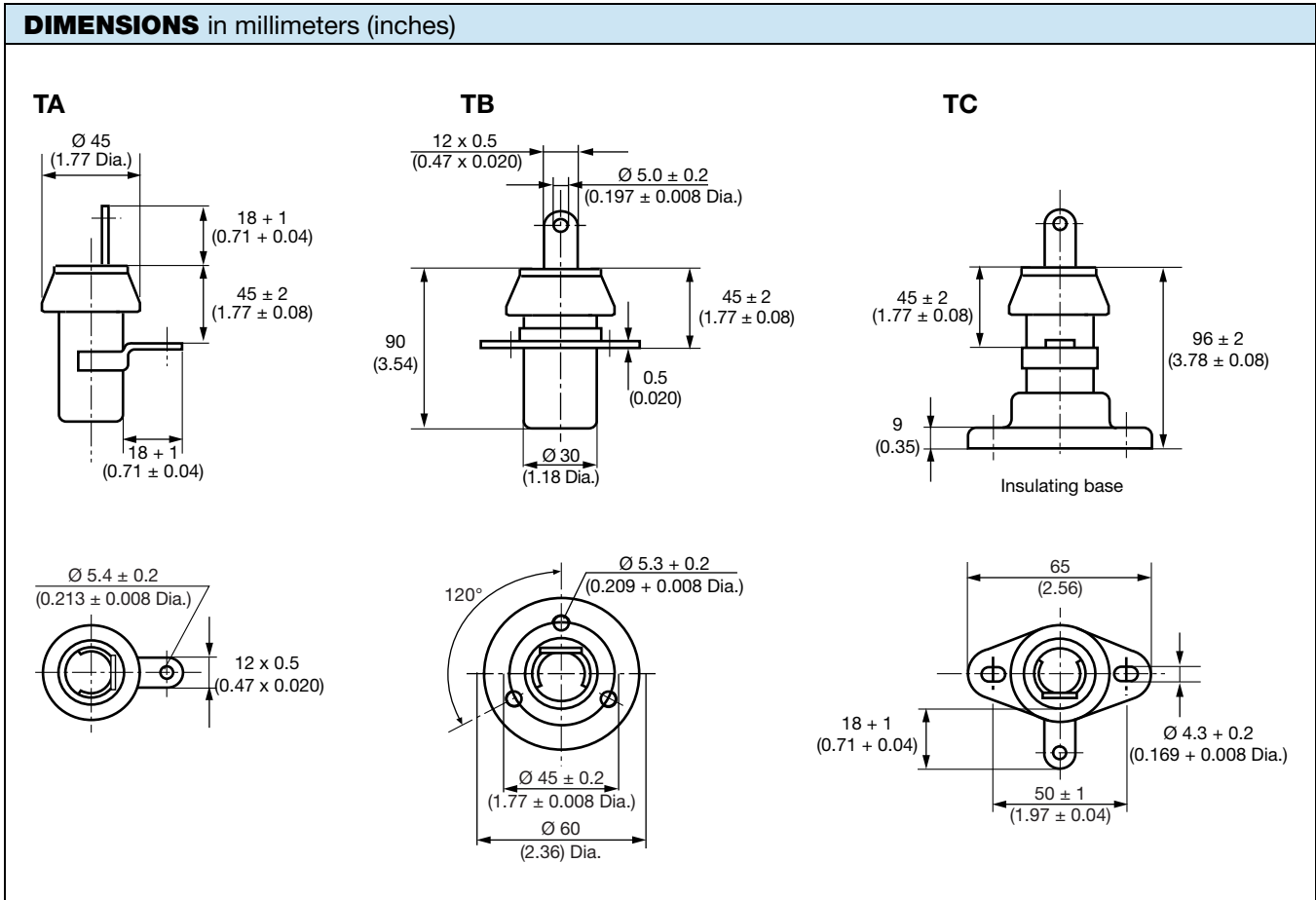

DIMENSIONS in millimeters (inches)

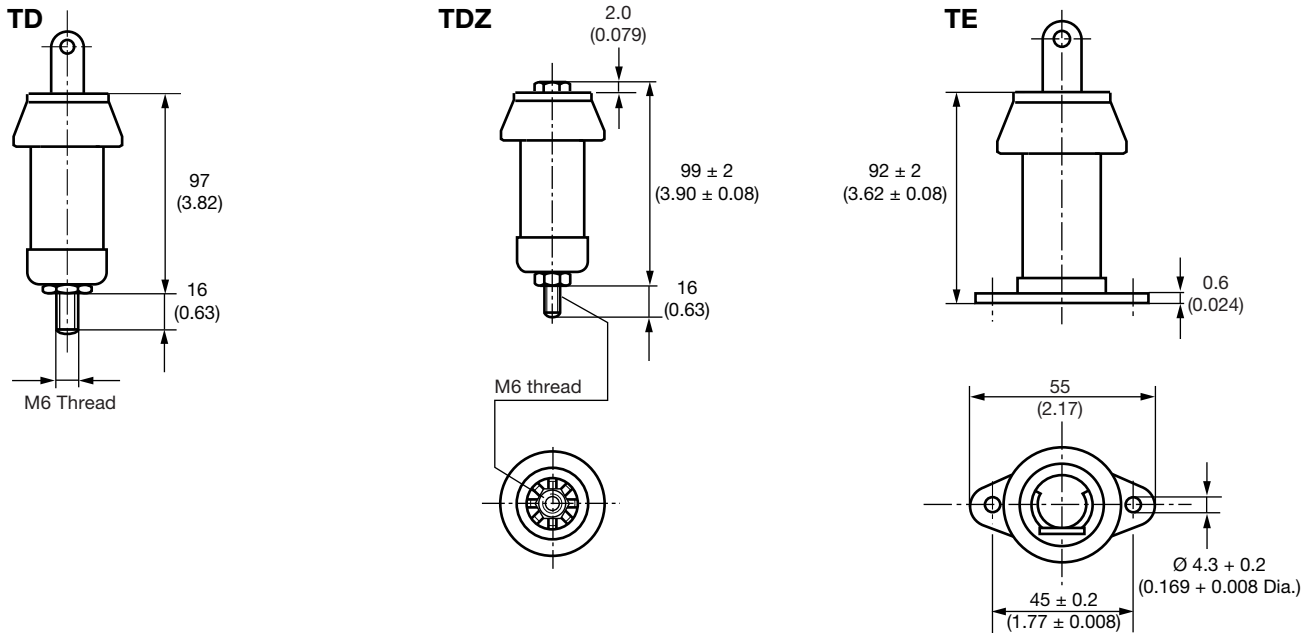

DERATING DIAGRAMS

T#030090BH500##BF1

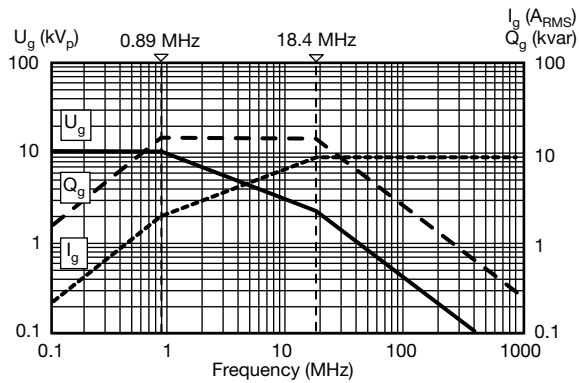

T#030090BH600##BF1

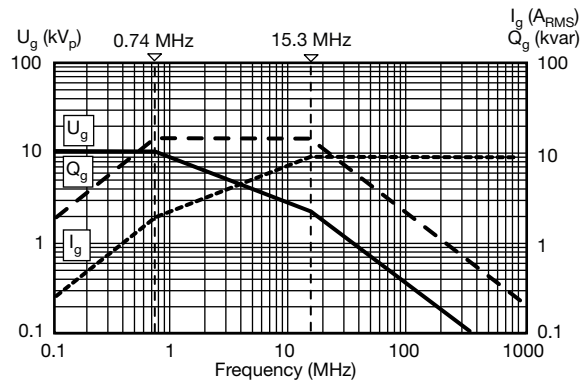

T#030090BH800##BF1

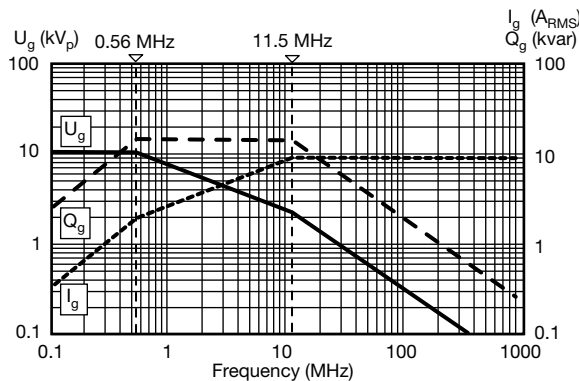

T#030090BH101##BG1

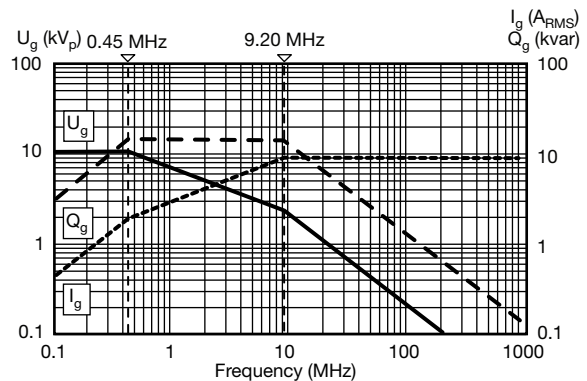

DERATING DIAGRAMS

T#030090BH121##BG1

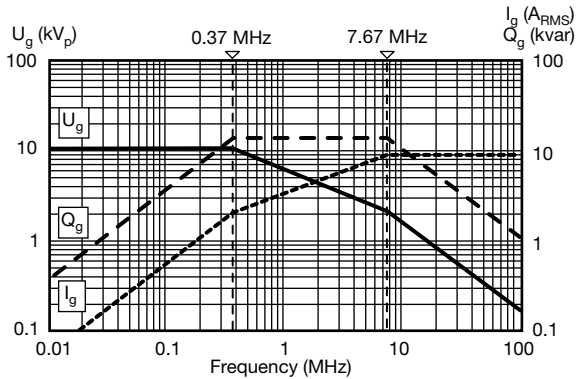

T#030090BH161##BG1

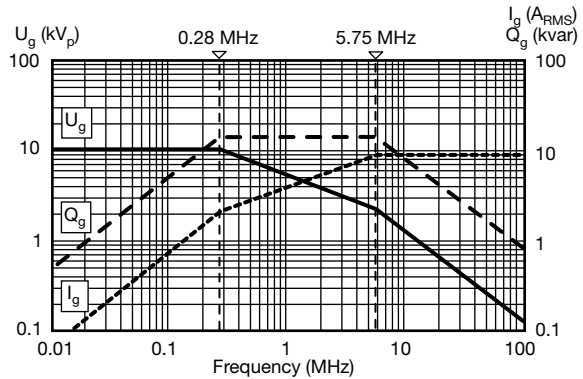

T#030090BH201##BH1

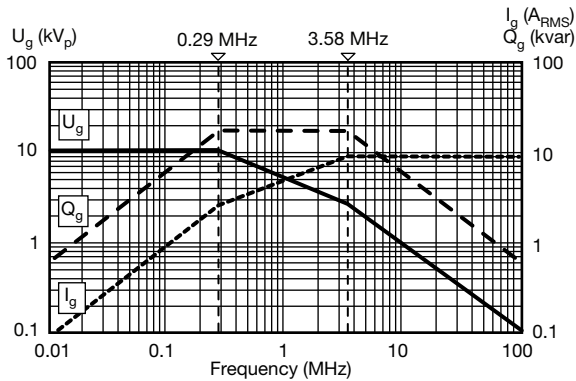

T#030090BH251##BH1

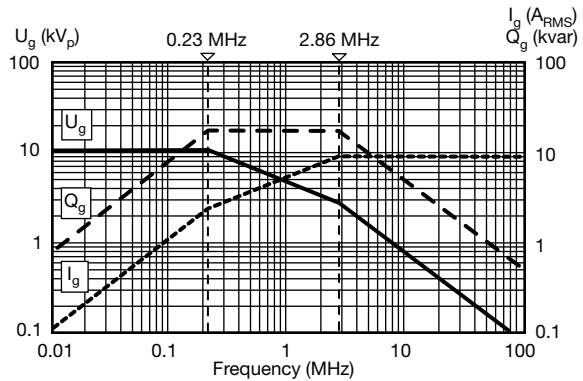

T#030090BH301##BH1

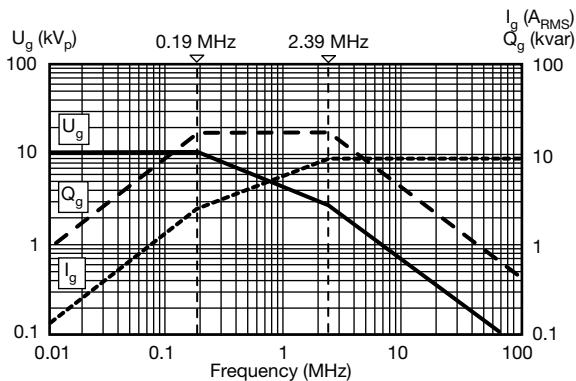

T#030090BH401##BH1

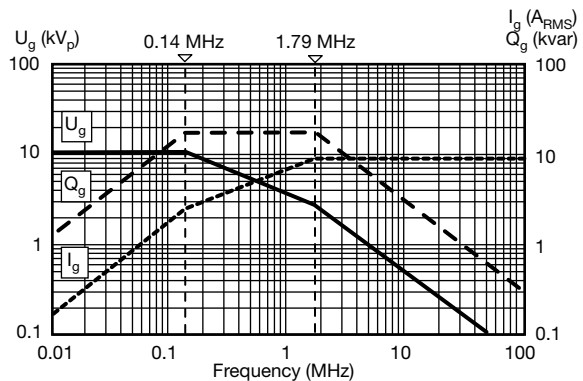

T#030090BH501##BJ1

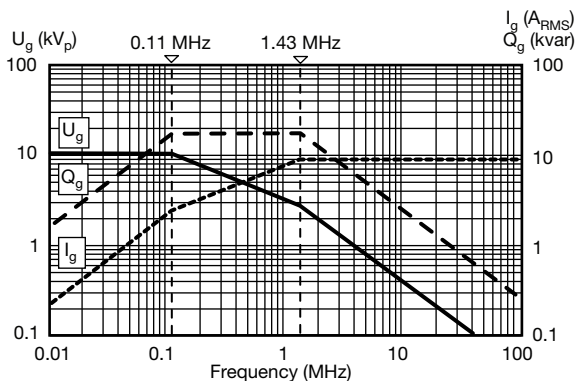

T#030090BH601##BJ1

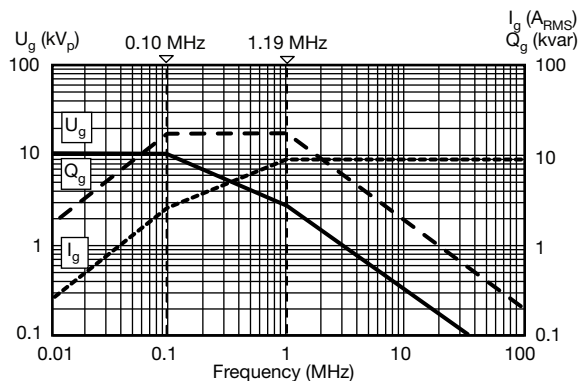



DERATING DIAGRAMS

T#030090BH801##BJ1

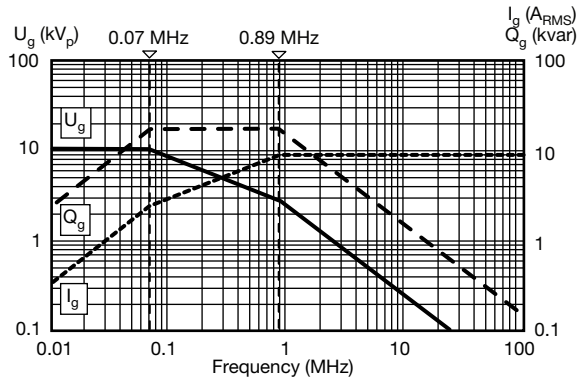

T#030090BH102##BJ1

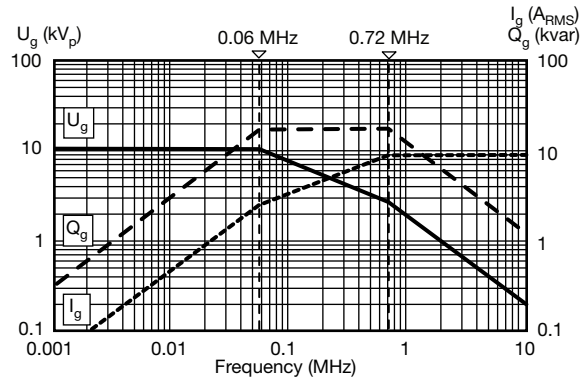

T#030090WC122##BJ1

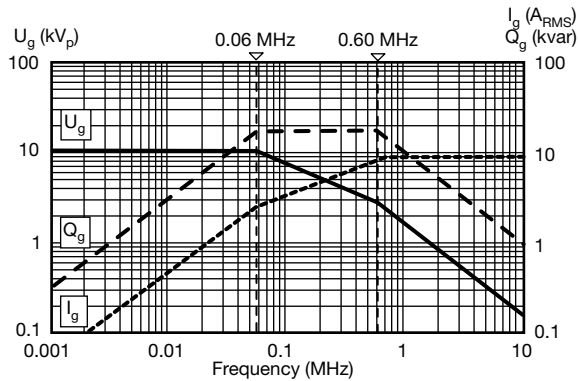

T#030090WC162##BJ1

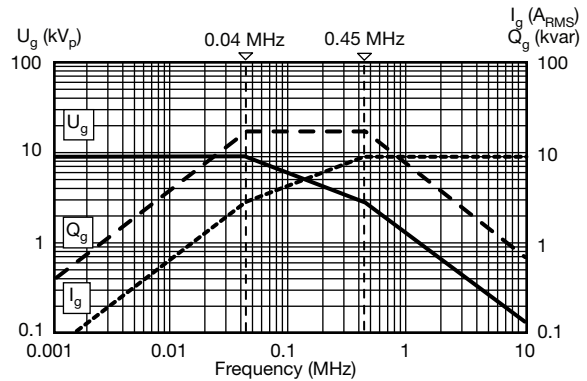

RELATED DOCUMENTS

General Information

www.vishay.com/doc?22071



Disclaimer

ALL PRODUCT, PRODUCT SPECIFICATIONS AND DATA ARE SUBJECT TO CHANGE WITHOUT NOTICE TO IMPROVE RELIABILITY, FUNCTION OR DESIGN OR OTHERWISE.

Vishay Intertechnology, Inc., its affiliates, agents, and employees, and all persons acting on its or their behalf (collectively, "Vishay"), disclaim any and all liability for any errors, inaccuracies or incompleteness contained in any datasheet or in any other disclosure relating to any product.

Vishay makes no warranty, representation or guarantee regarding the suitability of the products for any particular purpose or the continuing production of any product. To the maximum extent permitted by applicable law, Vishay disclaims (i) any and all liability arising out of the application or use of any product, (ii) any and all liability, including without limitation special, consequential or incidental damages, and (iii) any and all implied warranties, including warranties of fitness for particular purpose, non-infringement and merchantability.

Statements regarding the suitability of products for certain types of applications are based on Vishay's knowledge of typical requirements that are often placed on Vishay products in generic applications. Such statements are not binding statements about the suitability of products for a particular application. It is the customer's responsibility to validate that a particular product with the properties described in the product specification is suitable for use in a particular application. Parameters provided in datasheets and / or specifications may vary in different applications and performance may vary over time. All operating parameters, including typical parameters, must be validated for each customer application by the customer's technical experts. Product specifications do not expand or otherwise modify Vishay's terms and conditions of purchase, including but not limited to the warranty expressed therein.

Except as expressly indicated in writing, Vishay products are not designed for use in medical, life-saving, or life-sustaining applications or for any other application in which the failure of the Vishay product could result in personal injury or death. Customers using or selling Vishay products not expressly indicated for use in such applications do so at their own risk. Please contact authorized Vishay personnel to obtain written terms and conditions regarding products designed for such applications.

No license, express or implied, by estoppel or otherwise, to any intellectual property rights is granted by this document or by any conduct of Vishay. Product names and markings noted herein may be trademarks of their respective owners.