

FND300-1012G Power Supply

DC Input, 12V Output, 300 W



The FND300-1012G is a highly-efficient bus converter with one high current output, which can be used in a wide range of applications. Passive current share along with internal ORing diodes allow this unit to be also used in redundant, hot-swap applications.

The FND300 meets international safety standards and displays the CE Mark for the Low Voltage Directive.

Key Features & Benefits

- RoHS compliant for all six substances
- 40.5 to 72 VDC Input Range
- 12 V output
- 2000 VAC I/O electric strength test
- Highly-efficient topology
- High-density design
- 4" x 1.65" x 8.5" cassette
- I²C interface
- Supervisory signaling
- Overtemperature, output overvoltage, and output overcurrent protection
- ORing diode included for true redundant operation
- Safety approvals: UL60950-1/ CSA 60950-1, & TUV EN60950-1

Applications

- Telecommunication Equipment

North America

+1-866.513.2839

Asia-Pacific

+86.755.29885888

Europe, Middle East

+353 61 225 977

tech.support@psbel.com

belpowersolutions.com

FND300-1012G

Model Selection

MODEL	NOMINAL OUTPUT VOLTAGE (VDC)	INPUT CURRENT MAX (ADC)	ADJUSTMENT RANGE (VDC)	OUTPUT RATED CURRENT I _{RATED} (ADC)	OUTPUT RIPPLE/NOISE, mV p-p	TYPICAL EFFICIENCY @ I _{RATED} %
FND300-1012G	12	10	N/A	25	<120	>80

Input Specifications

PARAMETER	CONDITIONS / DESCRIPTION	MIN	NOM	MAX	UNITS
Input Voltage	With full output power	40.5	48/60	72	VDC
Inrush Current Limitation	48 / 60 VDC			<12 / 15	A
Efficiency	V _I nom, I _o nom			>80	%

Output Specifications

PARAMETER	CONDITIONS / DESCRIPTION	MIN	NOM	MAX	UNITS
Nominal Output Current V1	V _I min to V _I max		25		A
Output Voltage Setting V1	V _I nom, 12.5 A, T _c = 25 °C		12.0		VDC
Static Line Regulation V1	V _I min to V _I max, V _I nom, 5 to 100% I _o nom			±0.5	%
Static Load Regulation V1* *(Droop Characteristic)	V _I min to V _I max, V _I nom, 5 to 100% I _o nom			±5	%
Minimum Load	No minimum load requirements				
Hold-Up Time	At full load, starting at V _I = 60 VDC			>8	ms
Dynamic Load Regulation Settling Time	V1: ΔI _o = 8A, dI _o /dt = 2A/μs			±2 400	%Vout μs
Start-Up Time	V _I nom, I _o nom			<1	s
Output Voltage Ripple And Noise	V _I nom, I _o nom, 20 MHz BW			<120	mVp-p

Interface Signals and Internal Protection¹

PARAMETER	CONDITIONS / DESCRIPTION	MIN	NOM.	MAX	UNITS
Overvoltage Protection	Latch-style overvoltage protection.			14.5	V
Overcurrent Protection	(Latch-style) 110 to 120% I _o nom				
Overtemperature	Self-recovery; shut down at T _c = 95 °C				
Input Fuses	15 AF, Not user-accessible				
Input Transient Protection	VDR, reverse polarity protection				
I ² C Digital Bus	Reports information and monitors alarm functions				
PS Seated Signal	Contact closure to GND				
PS Remote Shut Down	TTL-compatible signal, inhibited at High or TTL "1"				
Power Fail	Indicates output voltage is out of regulation				
Fan Fail	Indicates low fan speed				
Current Share	Droop load characteristic				

FND300-1012G

Environmental, Mechanical Specifications & Reliability

PARAMETER	CONDITIONS/DESCRIPTION	MIN	NOM	MAX	UNITS
Operating Temperature	1/3 min to 1/3 max, 1/3 nom, cooling by internal fan	0		55	°C
Storage Temperature	Ambient	-40		85	°C
Operating Humidity	Relative Humidity, Non-cond.	10		90	%
Storage Humidity	Relative Humidity, Non-cond.	5		95	%
Shock	IEC/EN 60068-2-27, 11 ms			30	g
Sinusoidal Vibration	IEC/EN 60068-2-6			7.5	mm
	2 to 8 Hz			2	g _n
	8 to 200 Hz			4	g _n
Weight			1		kg
Dimensions	(Overall)	8.5 L (215.9)	4.0 W (101.6)	1.65 H (41.9)	in (mm)
MTBF	MIL-HDBK-217F Notice 2, G _B , 25 °C		150'000 (calculated)		h

Safety Regulatory Compliance & EMC

SAFETY AGENCY OR PARAMETER	STANDARD APPROVED TO:	MARKING OR RELATED TEST VALUE
UL/CSA	UL60950-1 / CSA 60950-1	
TUV Product Service	TUV EN60950-1	
Electric Strength Test Voltage	Class I, I/case (basic insulation)	1.41 kVDC
Electric Strength Test Voltage	Class I, I/O (reinforced insulation)	2.82 kVDC
Electrostatic Discharge	IEC/EN 61000-4-2, level 4 (contact/air)	8/15 kV, criterion B
Electromagnetic Field	IEC/EN 61000-4-3, level 3	10 V/m, criterion A
Electrical Fast Transients / Burst	IEC/EN 61000-4-4, level 4 (direct capacitive)	4/2 kV, criterion B
Surge	IEC/EN 61000-4-5, level 2 (L/L, L/C)	0.5/1 kV, criterion B
Electromagnetic Emissions	CISPR 22/EN 55022/EN61204 conducted/radiated	Class B

Output Connector Pin Allocation

PIN	SIGNAL NAME	DESCRIPTION
1-3, 13-15	V1 RTN	V1 Output Return
4-6, 16-18	V1	V1 Output
7	-	Not Used
8	-	Not Used
9	PF	Power Fail
10	I ² C	I ² C Voltage Input/Output
11	SDA	Serial Data Line
12	SCL	Serial Clock Line
19	-	Not Used
20	-	Not Used
21	LSB	Address Input Line
22	RSD	Power Supply Remote Shut Down
23	PS_PRSENT_L	Power Supply Present signal
24	Fan Fail	Fan Fail signal

866.513.2839

tech.support@psbel.com

belpowersolutions.com

FND300-1012G

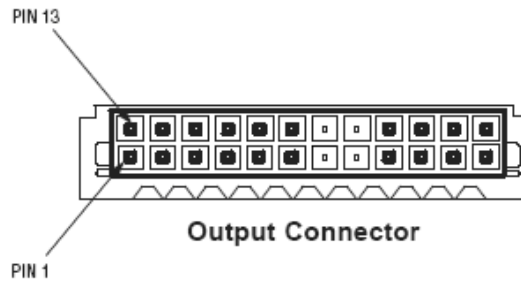

Connector Information

Power Supply:

Output - 24-Pin Molex connector 15-06-0241 with pre-plated tin over copper Molex terminals 39-00-0038

Mating Connections:

Output - 24-Pin Molex connector 15-06-0245 with pre-plated tin over copper Molex terminals 39-00-0040

Airflow Direction



Characteristic Curves

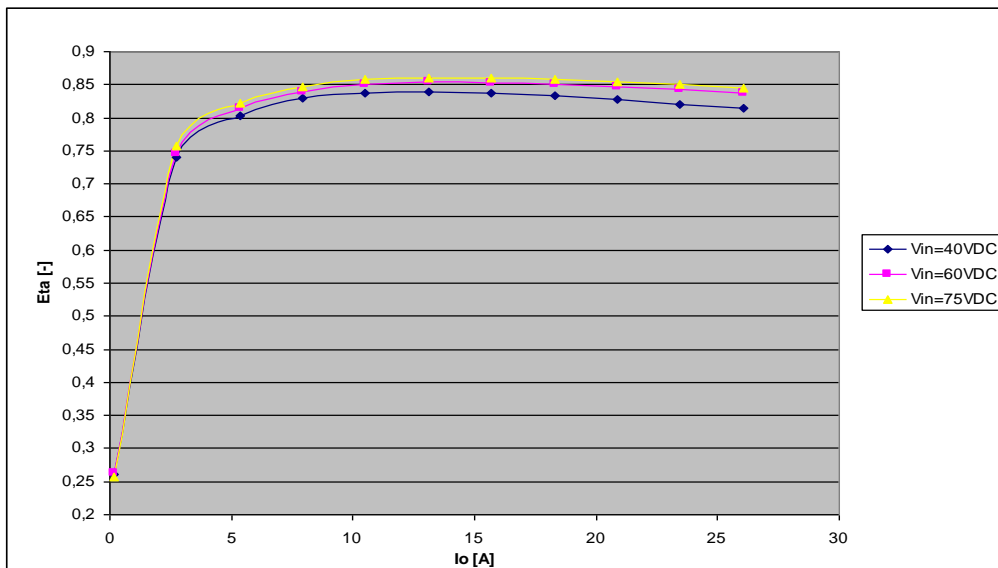

FND300-1012G

Figure 1 - Efficiency vs. Output Load

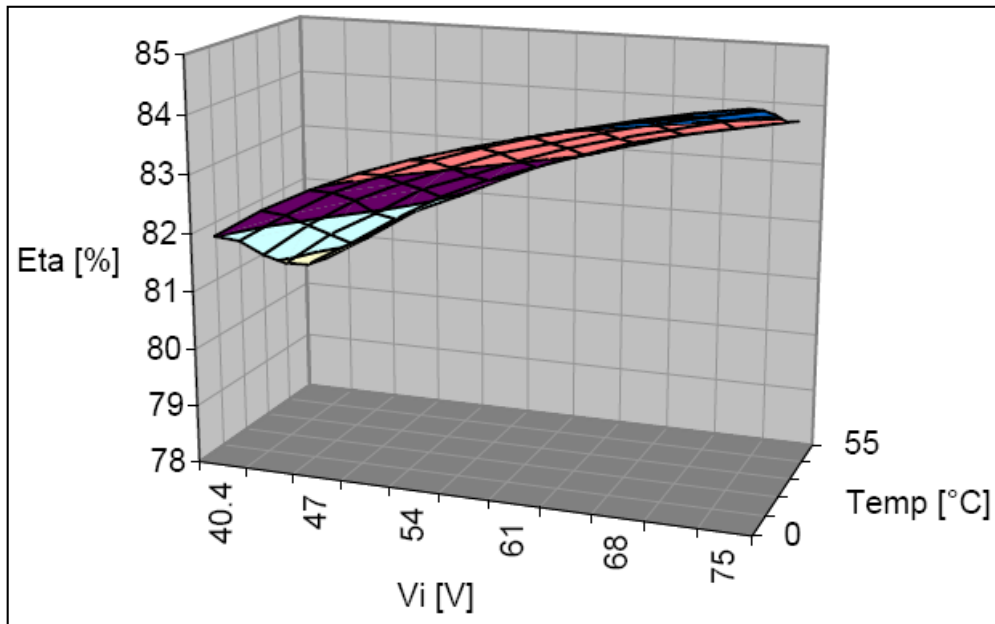

Figure 2 - Efficiency vs. Input Voltage and Ambient Temperature, $I_o=I_{onom}$

Mechanical

PARAMETER	CONDITIONS / DESCRIPTION
Overall Dimensions (L x W x H)	215.9 x 101.6 x 41.9 mm (8.5 x 4.0 x 1.65 inches)
Weight:	1 kg

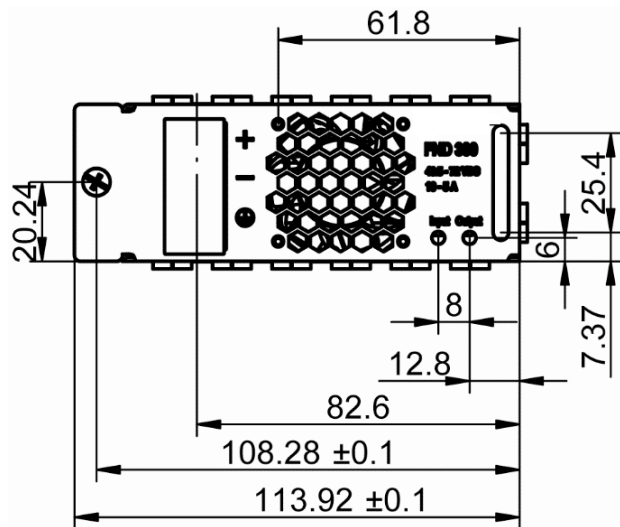

Figure 3 - Front View

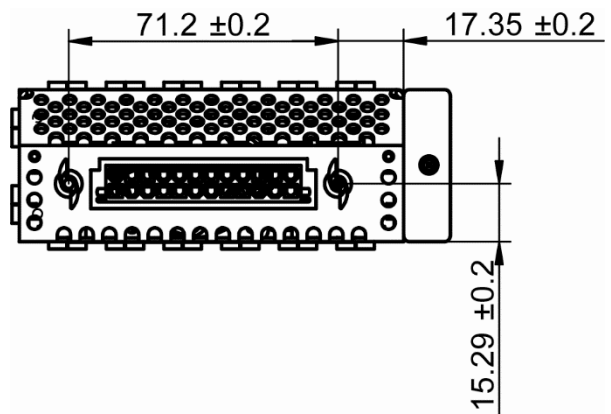

Figure 4 - Rear View

FND300-1012G

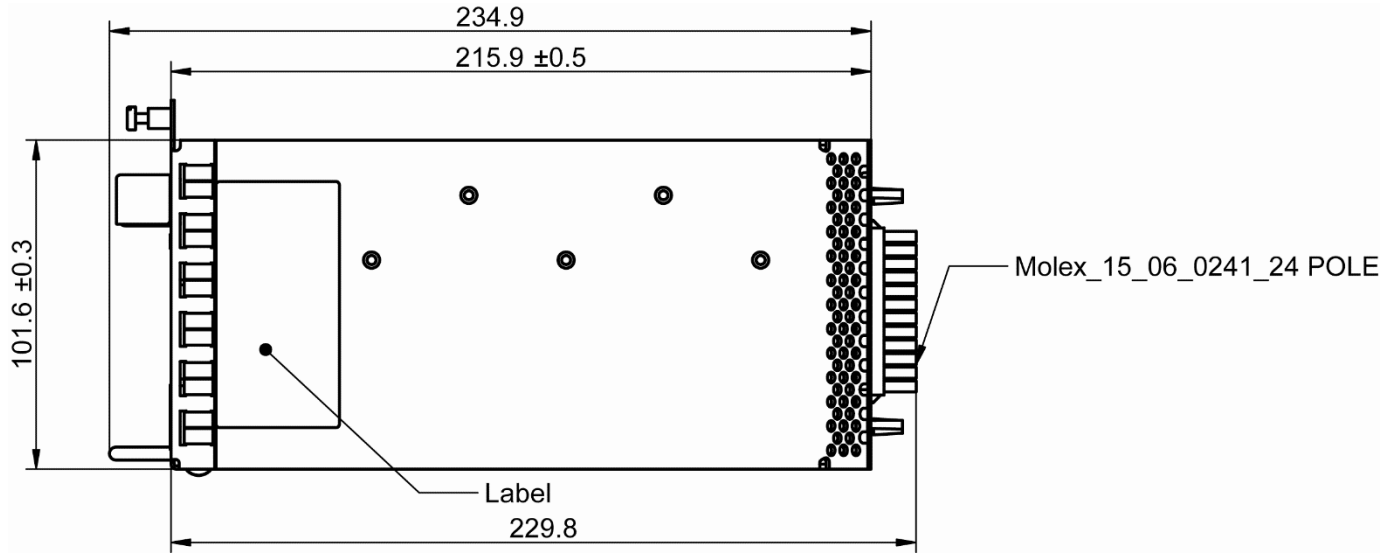

Figure 5 - Top View

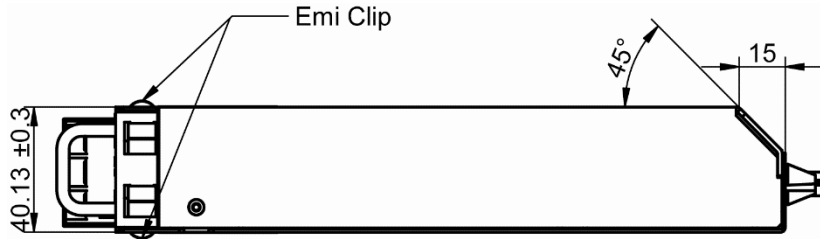

Figure 6 - Side View

For more information on these products consult: tech.support@psbel.com

NUCLEAR AND MEDICAL APPLICATIONS - Products are not designed or intended for use as critical components in life support systems, equipment used in hazardous environments, or nuclear control systems.

TECHNICAL REVISIONS - The appearance of products, including safety agency certifications pictured on labels, may change depending on the date manufactured. Specifications are subject to change without notice.