

YNV05T06 DC-DC Converter

3.0 - 5.5 VDC Input; 0.7525 - 3.63 VDC
Programmable @ 6 A

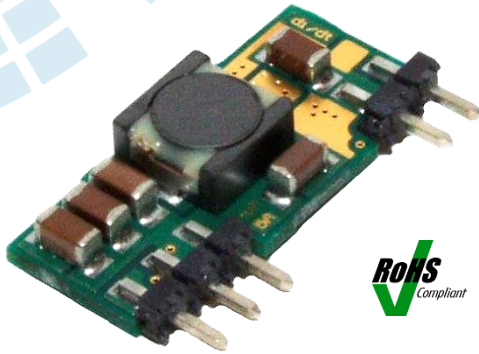

Key Features & Benefits

- RoHS lead-free solder and lead-solder-exempted products are available
- Delivers up to 6 A (21.7 W)
- No derating up to 70 °C ambient
- Industry-standard footprint and pinout
- Single-in-Line (SIP) Package: 0.90" x 0.44" x 0.213" (22.86 x 11.16 x 5.41 mm)
- Weight: 0.08 oz [2.22 g]
- Synchronous Buck Converter topology
- Start-up into pre-biased output
- No minimum load required
- Programmable output voltage via external resistor
- Remote ON/OFF
- Fixed-frequency operation
- Auto-reset output overcurrent protection
- Auto-reset overtemperature protection
- Operating ambient temperature: -40 °C to 85 °C
- High reliability, MTBF = TBD million hours
- All materials meet UL94, V-0 flammability rating
- Approved to the latest edition and amendment of ITE Safety standards, UL/CSA 60950-1 and IEC60950-1

Bel Power Solutions point-of-load converters are recommended for use with regulated bus converters in an Intermediate Bus Architecture (IBA). The YNV05T06 non-isolated DC-DC converter delivers up to 6A of output current in an industry-standard through-hole (SIP) package. Operating from a 3.0 – 5.5 V input, these converters are ideal choices for Intermediate Bus Architectures where point of load power delivery is preferred. It provides an extremely tight regulated programmable output voltage of 0.7525 V to 3.63 V.

The YNV05T06 converter provides exceptional thermal performance, even in high temperature environments with minimal airflow. This is accomplished through the use of patent pending circuits, packaging, and processing techniques to achieve ultra-high efficiency and excellent thermal management.

The preclusion of heat sinks minimizes impedance to system airflow, thus enhancing cooling for both upstream and downstream devices. The use of 100% automation for assembly, coupled with advanced power electronics and thermal design, results in a product with extremely high reliability.

Applications

- Intermediate Bus Architectures
- Telecommunications
- Data Communications
- Distributed Power Architectures
- Servers, Workstations

Benefits

- High efficiency – no heat sink required
- Reduces Total Solution Board Area
- Minimizes Part Numbers in Inventory

North America

+1-866.513.2839

Asia-Pacific

+86.755.29885888

Europe, Middle East

+353 61 225 977

tech.support@psbel.com
belpowersolutions.com

YNV05T06 DC-DC Converter

Electrical Specifications

Conditions: $T_A = 25\text{ }^\circ\text{C}$, Airflow = 200 LFM (1 m/s), $V_{in} = 5\text{ VDC}$, $V_{out} = 0.7525 - 3.63\text{ V}$, unless otherwise specified.

PARAMETER	NOTES	MIN	TYP	MAX	UNITS
ABSOLUTE MAXIMUM RATINGS					
Input Voltage	Continuous	-0.3		6	VDC
Operating Ambient Temperature		-40		85	$^\circ\text{C}$
Storage Temperature		-55		125	$^\circ\text{C}$
FEATURE CHARACTERISTICS					
Switching Frequency			300		kHz
Output Voltage Programming Range ¹	By external resistor, See Trim Table 1	0.7525		3.63	VDC
Turn-On Delay Time ²	Full resistive load				
With $V_{in} = (\text{Converter Enabled, then } V_{in} \text{ applied})$	From $V_{in} = V_{in}(\text{min})$ to $V_{o}=0.1 * V_o(\text{nom})$		3.5		ms
With Enable ($V_{in} = V_{in}(\text{nom})$) applied, then enabled	From enable to $V_{o}= 0.1 * V_o(\text{nom})$		3.5		ms
Rise time ² (Full resistive load)	From $0.1 * V_o(\text{nom})$ to $0.9 * V_o(\text{nom})$		3.5		ms
ON/OFF Control³					
Converter Off		2.4		5.5	VDC
Converter On		-5		0.8	VDC
INPUT CHARACTERISTICS					
Operating Input Voltage Range	For $V_{out} > 2.5\text{V}$ For $V_{out} \leq 2.5\text{V}$	4.5 3.0	5.0	5.5	VDC
Input Under Voltage Lockout					
Turn-on Threshold			2.05	2.15	VDC
Turn-off Threshold		1.75	1.9		VDC
Maximum Input Current					
$V_{in} = 4.5\text{V}$, $I_{out} = 6\text{A}$	$V_{OUT} = 3.3\text{ VDC}$			4.8	ADC
$V_{in} = 3.0\text{V}$, $I_{out} = 6\text{A}$	$V_{OUT} = 2.5\text{ VDC}$			5.5	ADC
$V_{in} = 3.0\text{V}$, $I_{out} = 6\text{A}$	$V_{OUT} = 2.0\text{ VDC}$			4.5	ADC
$V_{in} = 3.0\text{V}$, $I_{out} = 6\text{A}$	$V_{OUT} = 1.8\text{ VDC}$			4.2	ADC
$V_{in} = 3.0\text{V}$, $I_{out} = 6\text{A}$	$V_{OUT} = 1.5\text{ VDC}$			3.5	ADC
$V_{in} = 3.0\text{V}$, $I_{out} = 6\text{A}$	$V_{OUT} = 1.2\text{ VDC}$			2.9	ADC
$V_{in} = 3.0\text{V}$, $I_{out} = 6\text{A}$	$V_{OUT} = 1.0\text{ VDC}$			2.5	ADC
$V_{in} = 3.0\text{V}$, $I_{out} = 6\text{A}$	$V_{OUT} = 0.7525\text{ VDC}$			1.9	ADC
Input Stand-by Current (converter disabled)	$V_{in} = 5\text{ VDC}$		2		mA
Input No Load Current (Converter enabled)	$V_{in} = 5.5\text{ VDC}$				
	$V_{OUT} = 3.3\text{ VDC}$		53		mA
	$V_{OUT} = 2.5\text{ VDC}$		58		mA
	$V_{OUT} = 2.0\text{ VDC}$		53		mA
	$V_{OUT} = 1.8\text{ VDC}$		49		mA
	$V_{OUT} = 1.5\text{ VDC}$		46		mA
	$V_{OUT} = 1.2\text{ VDC}$		38		mA
	$V_{OUT} = 1.0\text{ VDC}$		34		mA
	$V_{OUT} = 0.7525\text{ VDC}$		27		mA
Input Reflected-Ripple Current - i_s	See Fig. F for setup. (BW = 20 MHz)		20		mA _{P-P}
Input Voltage Ripple Rejection	120 Hz		TBD		dB

+1.866.513.2839

tech.support@psbel.com

belpowersolutions.com

YNV05T06 DC-DC Converter

OUTPUT CHARACTERISTICS					
Output Voltage Set Point (no load)		-1.5	V _{out}	+1.5	%V _{out}
Output Regulation ⁴					
Over Line	V _{in} = 4.5V – 5.5V, Full resistive load		2		mV
	V _{in} = 3.0V – 3.6V, Full resistive load		3		mV
	V _{in} = 3.0V – 5.5V, Full resistive load		5		mV
Over Load	From no load to full load		0.4		%V _{out}
Output Voltage Range	(Overall operating input voltage, resistive load and temperature conditions until end of life)	-2.5		+2.5	%V _{out}
Output Ripple and Noise - 20MHz bandwidth (Fig. F)	Over line, load and temperature				
Peak-to-Peak (3.3V output)			35	50	mV _{P-P}
Peak-to-Peak (0.7525V output)			15	25	mV _{P-P}
External Load Capacitance	Plus full load (resistive)				
Min ESR > 1mΩ				1,000	μF
Min ESR > 10 mΩ				2,000	μF
Output Current Range		0		6	A
Output Current Limit Inception (I _{OUT})			10		A
Output Short- Circuit Current	Hiccup mode		4		Arms
DYNAMIC RESPONSE					
Load current change from 2.5A –5A, di/dt = 5 A/μS	Co = 47 μF ceramic. + 1 μF ceramic		80		mV
Settling Time (V _{OUT} < 10% peak deviation)			40		μs
Unloading current change 5A – 2.5A, di/dt =-5 A/μS	Co = 47 μF ceramic + 1 μF ceramic		85		mV
Settling Time (V _{OUT} < 10% peak deviation)			40		μs
EFFICIENCY					
	Full load (6A)				
	V _{OUT} = 3.3 VDC		93.0		%
	V _{OUT} = 2.5 VDC		90.5		%
	V _{OUT} = 2.0 VDC		88.5		%
	V _{OUT} = 1.8 VDC		87.5		%
	V _{OUT} = 1.5 VDC		85.5		%
	V _{OUT} = 1.2 VDC		83.0		%
	V _{OUT} = 1.0 VDC		81.0		%
	V _{OUT} = 0.7525 VDC		77.0		%

Notes:

- 1 The output voltage should not exceed 3.63V.
- 2 Note that start-up time is the sum of turn-on delay time and rise time
- 3 Converter is on if ON/OFF pin is left open.
- 4 Trim resistor connected across the GND and TRIM pins of the converter.

YNV05T06 DC-DC Converter

Operations

Input and Output Impedance

The YNV05T06 converter should be connected via a low impedance to the DC power source. In many applications, the inductance associated with the distribution from the power source to the input of the converter can affect the stability of the converter. It is recommended to use decoupling capacitors (minimum 47 μ F) placed as close as possible to the converter input pins in order to ensure stability of the converter and reduce input ripple voltage. Internally, the Converter has 20 μ F of Low ESR Ceramic Capacitance on board.

In a typical application, low ESR tantalum or POS capacitors (with sufficient ripple current rating) would be sufficient to provide adequate ripple voltage attenuation at the input of the converter. However, very low ESR ceramic capacitors 47 μ F-100 μ F are recommended at the input of the converter in order to minimize the input ripple voltage. They should be placed as close as possible to the input pins of the converter.

YNV05T06 has been designed for stable operation with or without external capacitance. Low ESR ceramic capacitors placed as close as possible to the load (Min 47 μ F) are recommended for improved transient performance and lower output voltage ripple.

It is important to keep low resistance and low inductance PCB traces when connecting the load to the output pins of the converter. This is required to maintain good load regulation since the converter does not have a SENSE pin for compensating voltage drops associated with the power distribution system on your PCB.

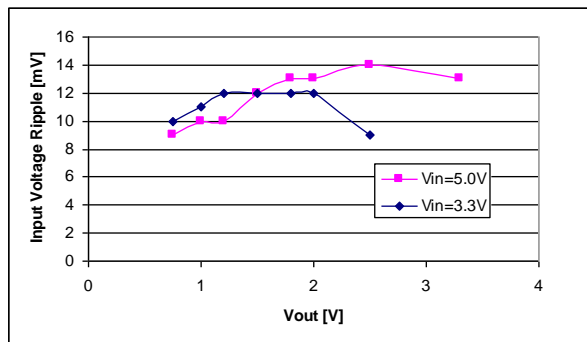

Fig. A: Input Voltage Ripple, $C_{IN} = 4 \times 47\mu\text{F}$ ceramic

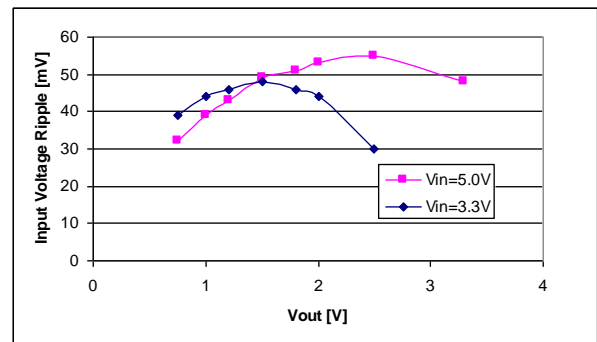

Fig. B: Input Voltage Ripple, $C_{IN} = 470\mu\text{F}$ polymer + $2 \times 47\mu\text{F}$ ceramic

Fig. A shows input voltage ripple for various output voltages using four 47 μ F input ceramic capacitors. The same plot is shown in Fig. B with one 470 μ F polymer capacitor (6TPB470M from Sanyo) in parallel with two 47 μ F ceramic capacitors at 5A load.

ON/OFF (Pin 5)

The ON/OFF pin (Pin 5) is used to turn the power converter on or off remotely via a system signal that is referenced to GND (Pin 3). Typical connections are shown in Fig. C.

To turn the converter on the ON/OFF pin should be at a logic low or left open, and to turn the converter off the ON/OFF pin should be at a logic high or connected to V_{in}

ON/OFF pin is internally pulled-down. A TTL or CMOS logic gate, open collector (open drain) transistor can be used to drive ON/OFF pin. When using open collector (open drain) transistor, add a pull-up resistor (R^*) of 10K to V_{in} as shown in Fig. C. External pull-up resistor (R^*) can be increased to 20K if minimum input voltage is more than 4.5V. This device must be capable of:

- sinking up to 0.6 mA at a low level voltage of ≤ 0.8 V
- sourcing up to 0.25 mA at a high logic level of 2.3V – 5.5V

YNV05T06 DC-DC Converter

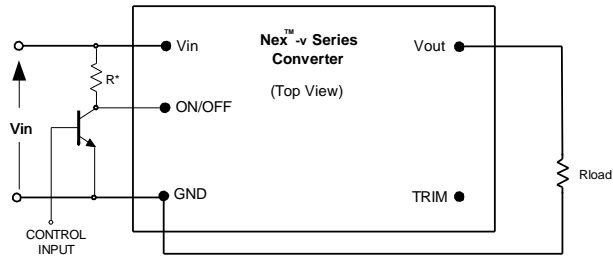

Fig. C: Circuit configuration for ON/OFF function.

Output Voltage Programming (Pin 2)

The output voltage can be programmed from 0.7525V to 3.63V by connecting an external resistor between TRIM pin (Pin 2) and GND pin (Pin 3); see Fig. D. Note that when a trim resistor is not connected, the output voltage of the converter is 0.7525V.

A trim resistor, R_{TRIM} , for a desired output voltage can be calculated using the following equation:

$$R_{TRIM} = \frac{21.07}{(V_{O-REQ} - 0.7525)} - 5.11 \quad [k\Omega]$$

where,

R_{TRIM} = Required value of trim resistor [kΩ]

V_{O-REQ} = Desired (trimmed) output voltage [V]

Note that the tolerance of a trim resistor directly affects the output voltage tolerance. It is recommended to use standard 1% or 0.5% resistors; for tighter tolerance, two resistors in parallel are recommended rather than one standard value from Table 1.

The ground pin of the trim resistor should be connected directly to the converter GND pin with no voltage drop in between. Table 1 provides the trim resistor values for popular output voltages.

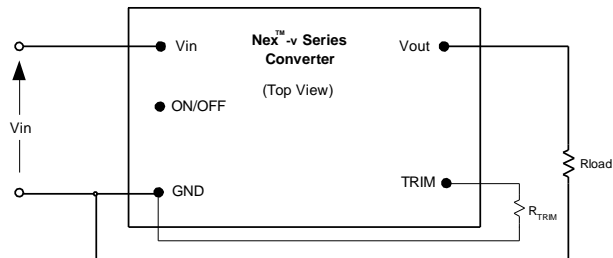

Fig. D: Configuration for programming output voltage

V_{O-REQ} [V]	R_{TRIM} [kΩ]	The Closest Standard Value [kΩ]
0.7525	open	
1.0	80.02	80.6
1.2	41.97	42.2
1.5	23.08	23.2
1.8	15.00	15
2.0	11.78	11.8
2.5	6.95	6.98
3.3	3.16	3.16
3.63	2.21	2.21

Table 1: Trim Resistor Value

+1.866.513.2839

tech.support@psbel.com

belpowersolutions.com

YNV05T06 DC-DC Converter

The output voltage can also be programmed by an external voltage source. To make trimming less sensitive, a series external resistor R_{EXT} is recommended between the TRIM pin and the programming voltage source. Control Voltage can be calculated by the formula:

$$V_{CTRL} = 0.7 - \frac{(5.11 + R_{EXT})(V_{O-REQ} - 0.7525)}{30.1} \quad [V]$$

where,

V_{CTRL} = Control voltage [V]

R_{EXT} = External resistor between TRIM pin and voltage source; the value can be chosen depending on the required output voltage range [k Ω]

Control voltages with $R_{EXT} = 0$ and $R_{EXT} = 15K$ are shown in Table 2.

V_{O-REQ} [V]	V_{CTRL} ($R_{EXT} = 0$)	V_{CTRL} ($R_{EXT} = 15 K$)
0.7525	0.700	0.700
1.0	0.658	0.535
1.2	0.624	0.401
1.5	0.573	0.201
1.8	0.522	0.000
2.0	0.488	-0.133
2.5	0.403	-0.468
3.3	0.268	-1.002
3.63	0.212	-1.223

Table 2: Control Voltage [Vdc]

Protection Features

Input Undervoltage Lockout

Input undervoltage lockout is standard with this converter. The converter will shut down when the input voltage drops below a pre-determined voltage; it will start automatically when V_{in} returns to a specified range.

The input voltage must be typically 2.05V for the converter to turn on. Once the converter has been turned on, it will shut off when the input voltage drops below typically 1.9V.

Output Overcurrent Protection (OCP)

The converter is protected against over-current and short circuit conditions. Upon sensing an over-current condition, the converter will enter hiccup mode. Once an overload or short-circuit condition is removed, V_{out} will return to nominal value.

Over-Temperature Protection (OTP)

The converter will shut down under an over-temperature condition to protect itself from overheating caused by operation outside the thermal derating curves, or operation in abnormal conditions such as system fan failure. After the converter has cooled to a safe operating temperature, it will automatically restart.

Safety Requirements

Approved to the latest edition and amendment of ITE Safety standards, UL/CSA 60950-1 and IEC60950-1.

The maximum DC voltage between any two pins is V_{in} under all operating conditions. Therefore, the unit has ELV (extra low voltage) output; it meets SELV requirements under the condition that all input voltages are ELV.

The converter is not internally fused. To comply with safety agencies requirements, a recognized fuse with a maximum rating of 15 Amps must be used in series with the input line.

+1.866.513.2839

tech.support@psbel.com

belpowersolutions.com

YNV05T06 DC-DC Converter

Characterization

General Information

The converter has been characterized for many operational aspects, to include thermal derating (maximum load current as a function of ambient temperature and airflow) for vertical and horizontal mounting, efficiency, start-up and shutdown parameters, output ripple and noise, transient response to load step-change, overload and short circuit.

The figures are numbered as Fig. x.y, where x indicates the different output voltages, and y associates with specific plots (y = 1 for the vertical thermal derating ...). For example, Fig. x.1 will refer to the vertical thermal derating for all the output voltages in general.

The following pages contain specific plots or waveforms associated with the converter. Additional comments for specific data are provided below.

Test Conditions

All thermal and efficiency data presented were taken with the converter soldered to a test board. Specifically, a 0.060" thick printed wiring board (PWB) with four layers. The top and bottom layers were not metalized. The two inner layers, comprising two-ounce copper, were used to provide traces for connectivity to the converter.

The lack of metalization on the outer layers as well as the limited thermal connection ensured that heat transfer from the converter to the PWB was minimized. This provides a worst-case but consistent scenario for thermal derating purposes.

All measurements requiring airflow were made in vertical and horizontal wind tunnel facilities using Infrared (IR) thermography and thermocouples for thermometry.

Ensuring components on the converter do not exceed their ratings is important to maintaining high reliability. If one anticipates operating the converter at or close to the maximum loads specified in the derating curves, it is prudent to check actual operating temperatures in the application. Thermographic imaging is preferable; if this capability is not available, then thermocouples may be used. Bel Power Solutions recommends the use of AWG #40 gauge thermocouples to ensure measurement accuracy. Careful routing of the thermocouple leads will further minimize measurement error. Refer to Fig. E for optimum measuring thermocouple location.

Thermal Derating

Load current vs. ambient temperature and airflow rates are given in Figs. x.1 to x.2 for maximum temperature of 120°C. Ambient temperature was varied between 25°C and 85°C, with airflow rates from 30 to 500 LFM (0.15m/s to 2.5 m/s), for $V_{in} = 5V$ and $V_{in} = 3.3V$, and vertical or horizontal converter mounting.

For each set of conditions, the maximum load current was defined as the lowest of:

- (i) The output current at which any MOSFET temperature does not exceed a maximum specified temperature (120°C) as indicated by the thermographic image, or
- (ii) The maximum current rating of the converter (6A)

During normal operation, derating curves with maximum FET temperature less than or equal to 120°C should not be exceeded. Temperature on the PCB at the thermocouple locations shown in Fig. E should not exceed 120°C in order to operate inside the derating curves.

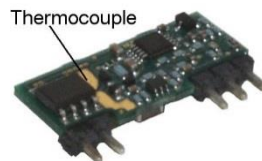

Fig. E: Location of the thermocouple for thermal testing.

Efficiency

Fig. x.3 show the efficiency vs. load current plot for ambient temperature of 25°C, airflow rate of 200 LFM (1 m/s) with vertically or horizontally mounting and input voltages of 4.5V, 5.0V and 5.5V.

Fig. x.4 show the efficiency vs. load current plot for ambient temperature of 25°C, airflow rate of 200 LFM (1 m/s) with vertically or horizontally mounting and input voltages of 3.0V, 3.3V, and 3.6V for output voltages 2.5V.

+1.866.513.2839

tech.support@psbel.com

belpowersolutions.com

YNV05T06 DC-DC Converter

Power Dissipation

Fig. 3.3V.4 shows the power dissipation vs. load current plot for $T_a = 25^\circ\text{C}$, airflow rate of 200 LFM (1 m/s) with vertically or horizontally mounting and input voltages of 4.5V, 5.0V and 5.5V for 3.3V output voltage.

Ripple and Noise

The output voltage ripple waveform is measured at full rated load current. Note that all output voltage waveforms are measured across a $1\ \mu\text{F}$ ceramic capacitor.

The output voltage ripple and input reflected ripple current waveforms are obtained using the test setup shown in Fig. F

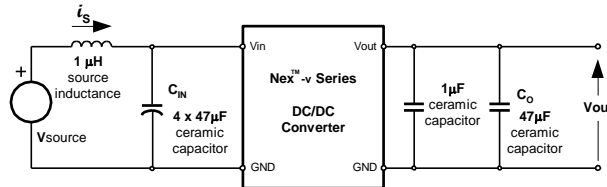

Fig. F: Test setup for measuring input reflected ripple currents, i_s and output voltage ripple

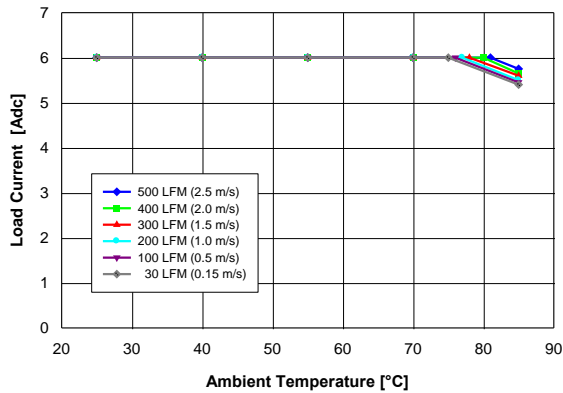

Fig. 3.3V.1: Available load current vs. ambient temperature and airflow rates for $V_{out} = 3.3\text{V}$ converter mounted vertically with $V_{in} = 5\text{V}$, air flowing from pin 5 to pin 1, and maximum MOSFET temperature $\leq 120^\circ\text{C}$.

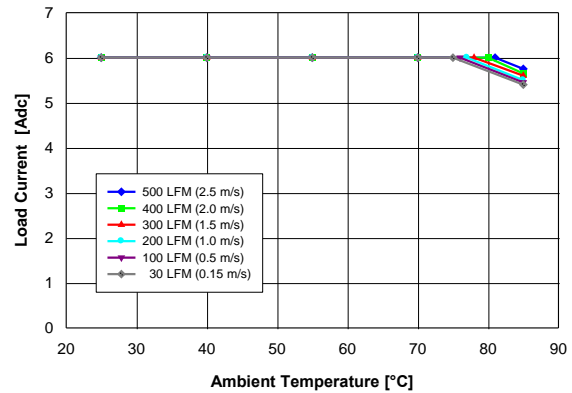

Fig. 3.3V.2: Available load current vs. ambient temperature and airflow rates for $V_{out} = 3.3\text{V}$ converter mounted horizontally with $V_{in} = 5\text{V}$, air flowing from pin 1 to pin 5, and maximum MOSFET temperature $\leq 120^\circ\text{C}$.

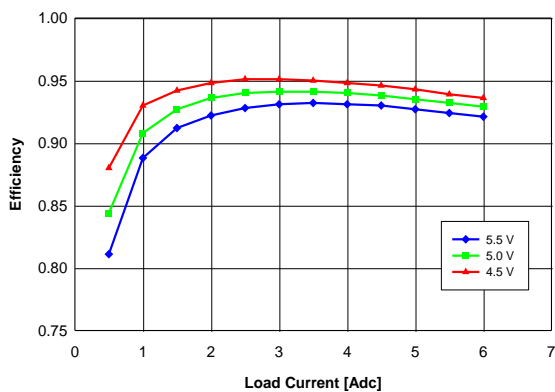

Fig. 3.3V.3: Efficiency vs. load current and input voltage for $V_{out} = 3.3\text{V}$ converter mounted vertically or horizontally with air flowing from pin 5 to pin 1 at a rate of 200 LFM (1 m/s) and $T_a = 25^\circ\text{C}$.

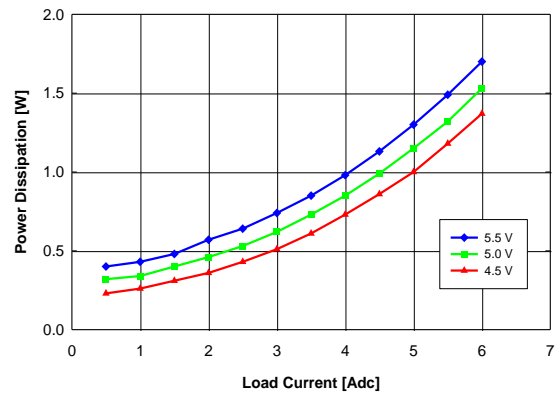

Fig. 3.3V.4: Power loss vs. load current and input voltage for $V_{out} = 3.3\text{V}$ converter mounted vertically or horizontally with air flowing from pin 5 to pin 1 at a rate of 200 LFM (1 m/s) and $T_a = 25^\circ\text{C}$.

YNV05T06 DC-DC Converter

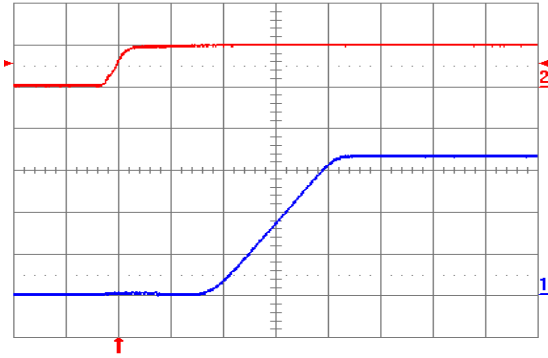

Fig. 3.3V.5: Turn-on transient for $V_{out} = 3.3V$ with application of V_{in} at full rated load current (resistive) and $47\mu F$ external capacitance at $V_{in} = 5V$. Top trace: V_{in} (5V/div.); Bottom trace: output voltage (1V/div.); Time scale: 2ms/div.

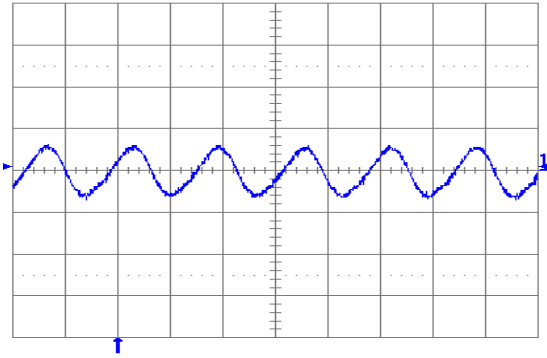

Fig. 3.3V.6: Output voltage ripple (20mV/div.) at full rated load current into a resistive load with external capacitance $47\mu F$ ceramic + $1\mu F$ ceramic and $V_{in} = 5V$ for $V_{out} = 3.3V$. Time scale: 2μs/div.

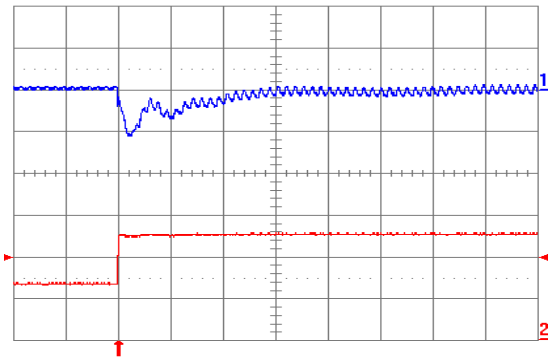

Fig. 3.3V.7: Output voltage response for $V_{out} = 3.3V$ to positive load current step change from 2.5A to 5A with slew rate of $5A/\mu s$ at $V_{in} = 5V$. Top trace: output voltage (100mV/div.); Bottom trace: load current (2A/div.). $C_o = 47\mu F$ ceramic. Time scale: 20μs/div.

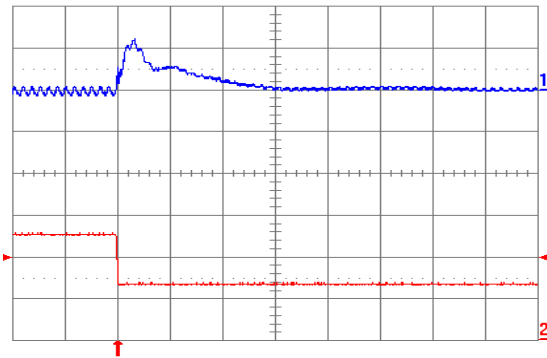

Fig. 3.3V.8: Output voltage response for $V_{out} = 3.3V$ to negative load current step change from 5A to 2.5A with slew rate of $-5A/\mu s$ at $V_{in} = 5V$. Top trace: output voltage (100mV/div.); Bottom trace: load current (2A/div.). $C_o = 47\mu F$ ceramic. Time scale: 20μs/div.

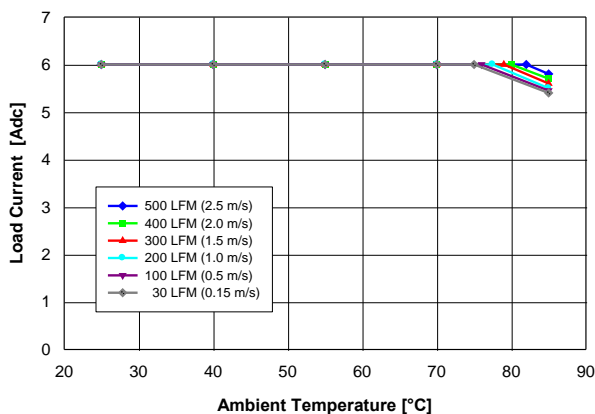

Fig. 2.5V.1: Available load current vs. ambient temperature and airflow rates for $V_{out} = 2.5V$ converter mounted vertically or horizontally with $V_{in} = 5V$, air flowing from pin 5 to pin 1, and maximum MOSFET temperature $\leq 120^\circ C$.

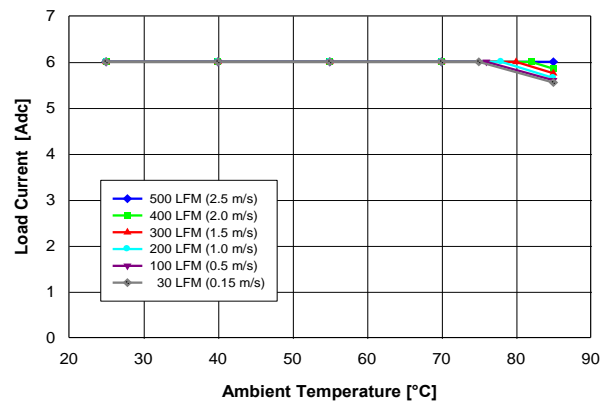

Fig. 2.5V.2: Available load current vs. ambient temperature and airflow rates for $V_{out} = 2.5V$ converter mounted vertically or horizontally with $V_{in} = 3.3V$, air flowing from pin 5 to pin 1, and maximum MOSFET temperature $\leq 120^\circ C$.

YNV05T06 DC-DC Converter

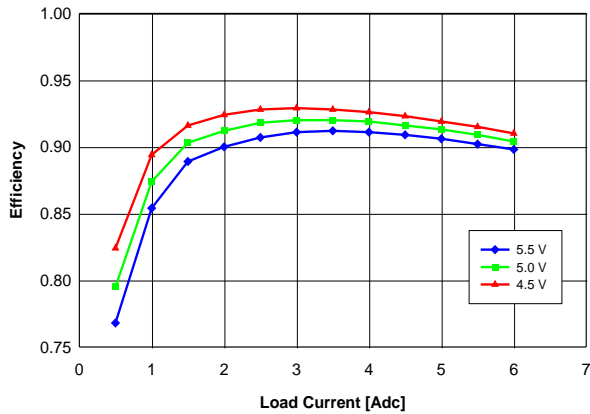

Fig. 2.5V.3: Efficiency vs. load current and input voltage for $V_{out} = 2.5V$ converter mounted vertically or horizontally with air flowing from pin 5 to pin 1 at a rate of 200 LFM (1 m/s) and $T_a = 25^{\circ}C$.

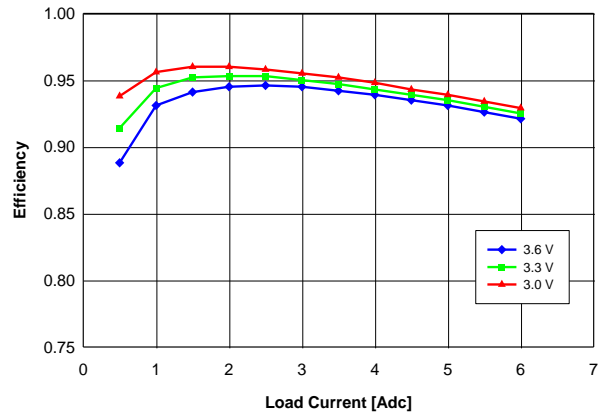

Fig. 2.5V.4: Efficiency vs. load current and input voltage for $V_{out} = 2.5V$ converter mounted vertically or horizontally with air flowing from pin 5 to pin 1 at a rate of 200 LFM (1 m/s) and $T_a = 25^{\circ}C$.

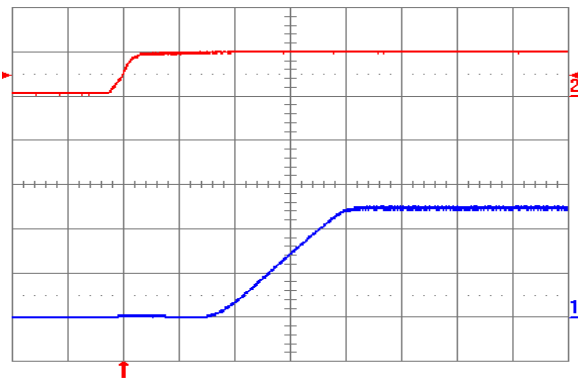

Fig. 2.5V.5: Turn-on transient for $V_{out} = 2.5V$ with application of V_{in} at full rated load current (resistive) and $47\mu F$ external capacitance at $V_{in} = 5V$. Top trace: V_{in} (5V/div.); Bottom trace: output voltage (1V/div.); Time scale: 2ms/div.

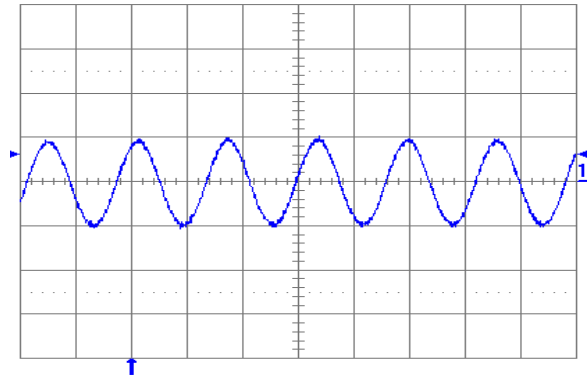

Fig. 2.5V.6: Output voltage ripple (20mV/div.) at full rated load current into a resistive load with external capacitance $47\mu F$ ceramic + $1\mu F$ ceramic and $V_{in} = 5V$ for $V_{out} = 2.5V$. Time scale: $2\mu s$ /div.

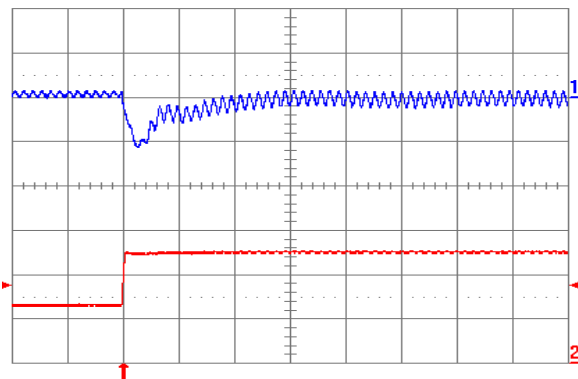

Fig. 2.5V.7: Output voltage response for $V_{out} = 2.5V$ to positive load current step change from 2.5A to 5A with slew rate of $5A/\mu s$ at $V_{in} = 5V$. Top trace: output voltage (100mV/div.); Bottom trace: load current (2A/div.). $C_o = 47\mu F$ ceramic. Time scale: $20\mu s$ /div.

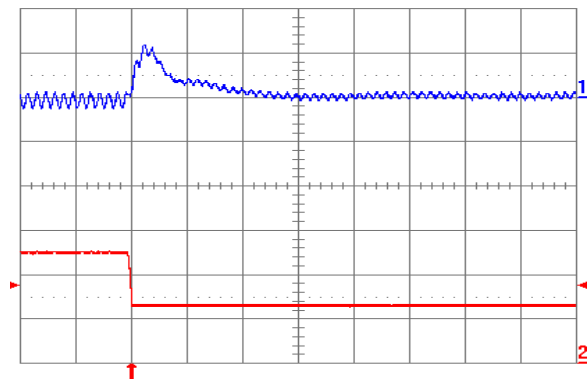

Fig. 2.5V.8: Output voltage response for $V_{out} = 2.5V$ to negative load current step change from 5A to 2.5A with slew rate of $-5A/\mu s$ at $V_{in} = 5V$. Top trace: output voltage (100mV/div.); Bottom trace: load current (2A/div.). $C_o = 47\mu F$ ceramic. Time scale: $20\mu s$ /div.

+1.866.513.2839

tech.support@psbel.com

belpowersolutions.com

YNV05T06 DC-DC Converter

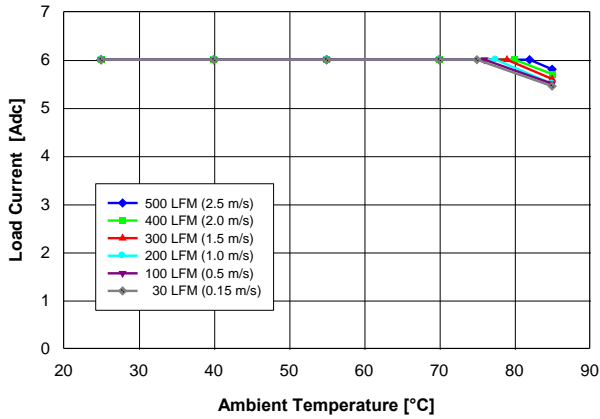

Fig. 2.0V.1: Available load current vs. ambient temperature and airflow rates for $V_{out} = 2.0V$ converter mounted vertically or horizontally with $V_{in} = 5V$, air flowing from pin 5 to pin 1, and maximum MOSFET temperature $\leq 120^{\circ}C$.

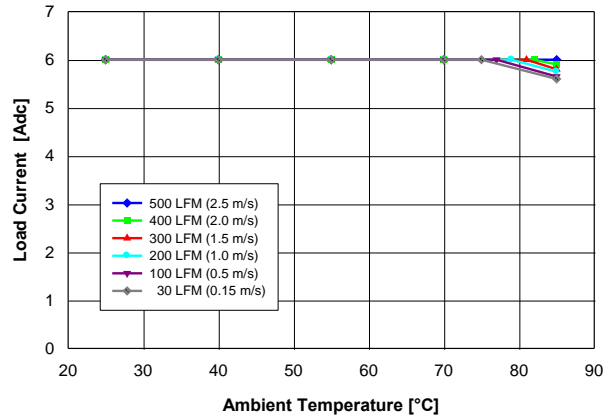

Fig. 2.0V.2: Available load current vs. ambient temperature and airflow rates for $V_{out} = 2.0V$ converter mounted vertically or horizontally with $V_{in} = 3.3V$, air flowing from pin 5 to pin 1, and maximum MOSFET temperature $\leq 120^{\circ}C$.

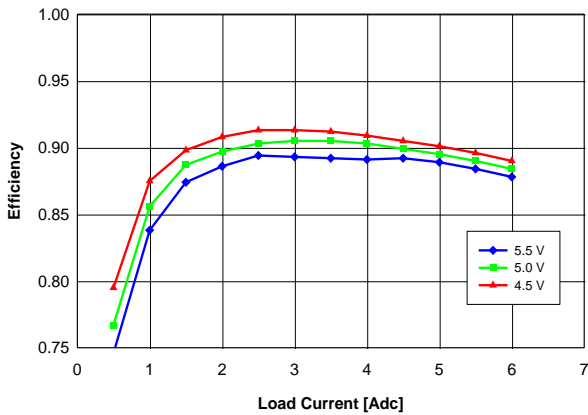

Fig. 2.0V.3: Efficiency vs. load current and input voltage for $V_{out} = 2.0V$ converter mounted vertically or horizontally with air flowing from pin 5 to pin 1 at a rate of 200 LFM (1 m/s) and $T_a = 25^{\circ}C$.

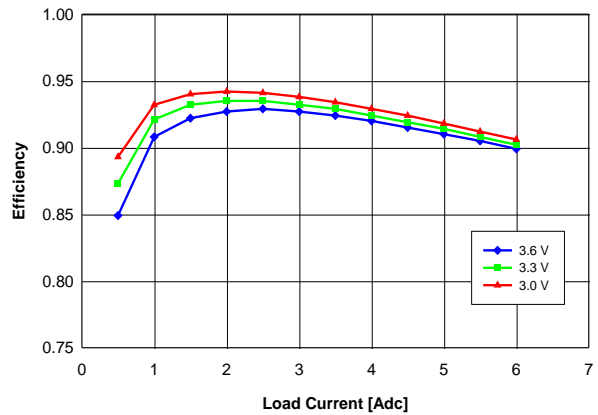

Fig. 2.0V.4: Efficiency vs. load current and input voltage for $V_{out} = 2.0V$ converter mounted vertically or horizontally with air flowing from pin 5 to pin 1 at a rate of 200 LFM (1 m/s) and $T_a = 25^{\circ}C$.

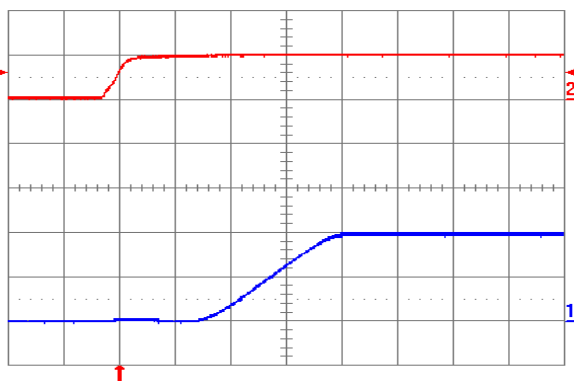

Fig. 2.0V.5: Turn-on transient for $V_{out} = 2.0V$ with application of V_{in} at full rated load current (resistive) and $47\mu F$ external capacitance at $V_{in} = 5V$. Top trace: V_{in} (5V/div.); Bottom trace: output voltage (1V/div.); Time scale: 2ms/div.

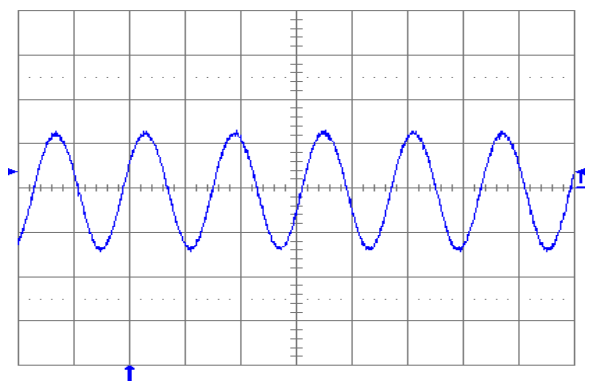

Fig. 2.0V.6: Output voltage ripple (20mV/div.) at full rated load current into a resistive load with external capacitance $47\mu F$ ceramic + $1\mu F$ ceramic and $V_{in} = 5V$ for $V_{out} = 2.0V$. Time scale: 2 μs /div.

YNV05T06 DC-DC Converter

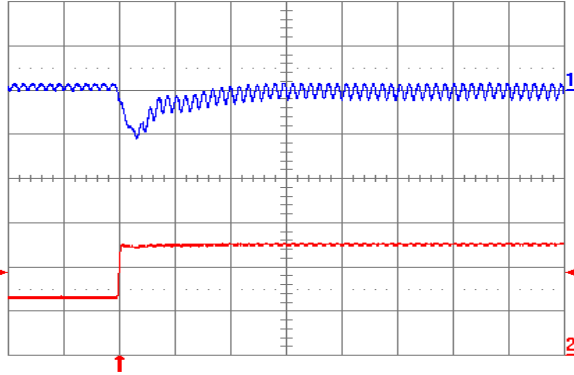

Fig. 2.0V.7: Output voltage response for $V_{out} = 2.0V$ to positive load current step change from 2.5A to 5A with slew rate of $5A/\mu s$ at $V_{in} = 5V$. Top trace: output voltage (100mV/div.); Bottom trace: load current (2A/div.). $C_o = 47\mu F$ ceramic. Time scale: $20\mu s/div$.

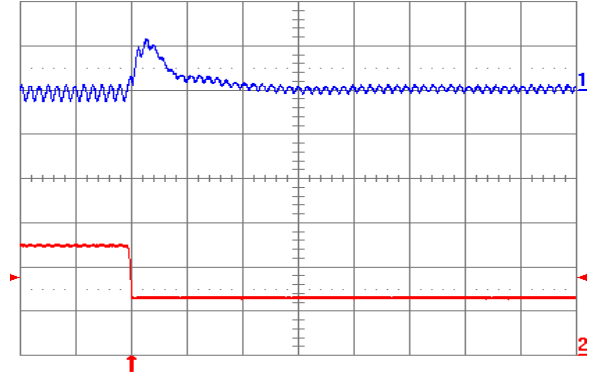

Fig. 2.0V.8: Output voltage response for $V_{out} = 2.0V$ to negative load current step change from 5A to 2.5A with slew rate of $-5A/\mu s$ at $V_{in} = 5V$. Top trace: output voltage (100mV/div.); Bottom trace: load current (2A/div.). $C_o = 47\mu F$ ceramic. Time scale: $20\mu s/div$.

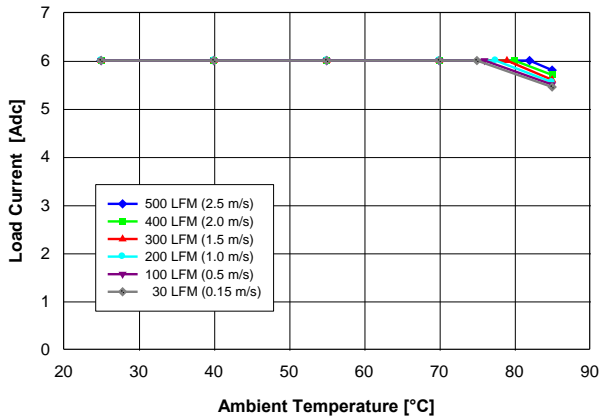

Fig. 1.8V.1: Available load current vs. ambient temperature and airflow rates for $V_{out} = 1.8V$ converter mounted vertically or horizontally with $V_{in} = 5V$, air flowing from pin 5 to pin 1, and maximum MOSFET temperature $\leq 120^\circ C$.

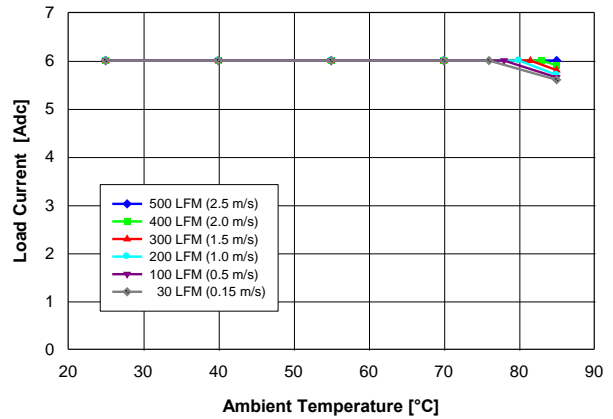

Fig. 1.8V.2: Available load current vs. ambient temperature and airflow rates for $V_{out} = 1.8V$ converter mounted vertically or horizontally with $V_{in} = 3.3V$, air flowing from pin 5 to pin 1, and maximum MOSFET temperature $\leq 120^\circ C$.

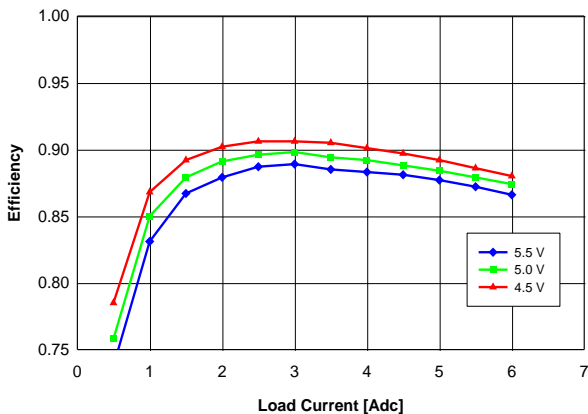

Fig. 1.8V.3: Efficiency vs. load current and input voltage for $V_{out} = 1.8V$ converter mounted vertically or horizontally with air flowing from pin 5 to pin 1 at a rate of 200 LFM (1 m/s) and $T_a = 25^\circ C$.

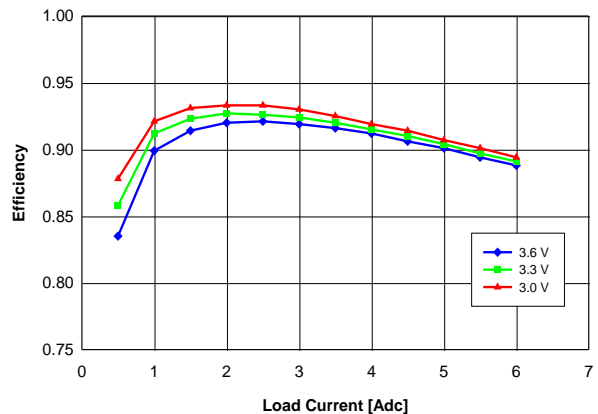

Fig. 1.8V.4: Efficiency vs. load current and input voltage for $V_{out} = 1.8V$ converter mounted vertically or horizontally with air flowing from pin 5 to pin 1 at a rate of 200 LFM (1 m/s) and $T_a = 25^\circ C$.

YNV05T06 DC-DC Converter

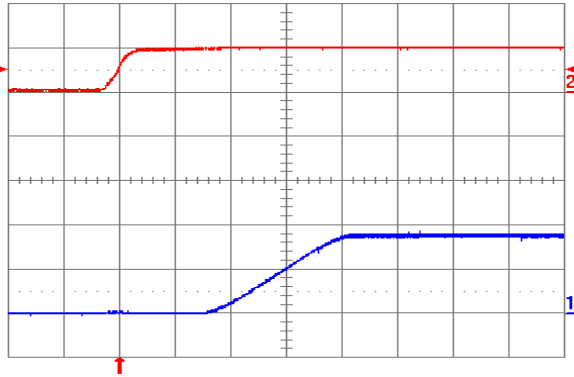

Fig. 1.8V.5: Turn-on transient for $V_{out} = 1.8V$ with application of V_{in} at full rated load current (resistive) and $47\mu F$ external capacitance at $V_{in} = 5V$. Top trace: V_{in} (5V/div.); Bottom trace: output voltage (1V/div.); Time scale: 2ms/div.

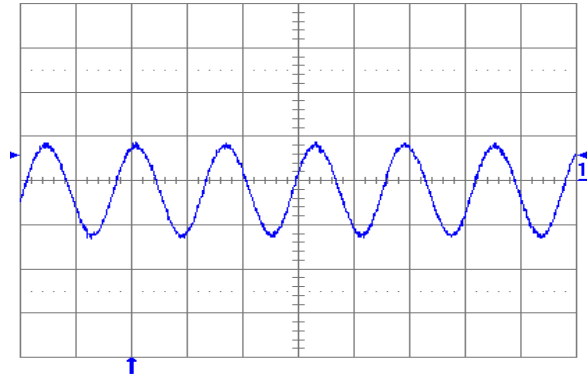

Fig. 1.8V.6: Output voltage ripple (20mV/div.) at full rated load current into a resistive load with external capacitance $47\mu F$ ceramic + $1\mu F$ ceramic and $V_{in} = 5V$ for $V_{out} = 1.8V$. Time scale: $2\mu s$ /div.

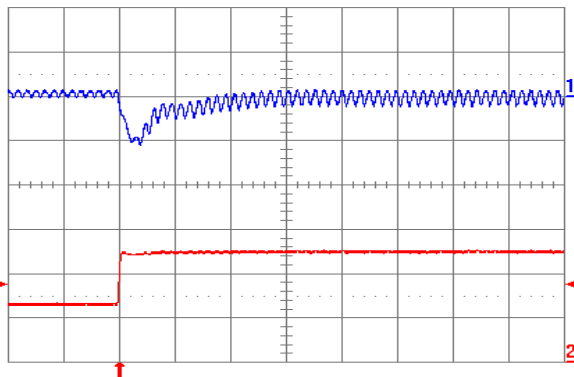

Fig. 1.8V.7: Output voltage response for $V_{out} = 1.8V$ to positive load current step change from 2.5A to 5A with slew rate of $5A/\mu s$ at $V_{in} = 5V$. Top trace: output voltage (100mV/div.); Bottom trace: load current (2A/div.). $C_o = 47\mu F$ ceramic. Time scale: $20\mu s$ /div.

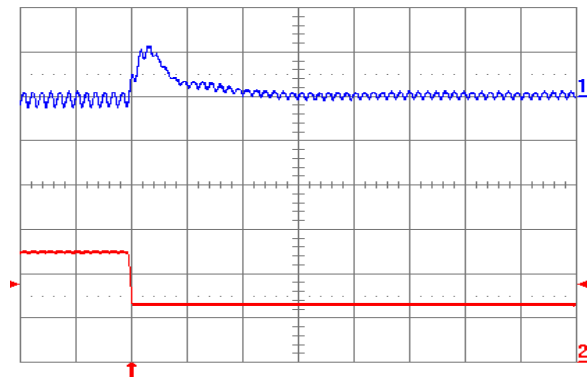

Fig. 1.8V.8: Output voltage response for $V_{out} = 1.8V$ to negative load current step change from 5A to 2.5A with slew rate of $-5A/\mu s$ at $V_{in} = 5V$. Top trace: output voltage (100mV/div.); Bottom trace: load current (2A/div.). $C_o = 47\mu F$ ceramic. Time scale: $20\mu s$ /div.

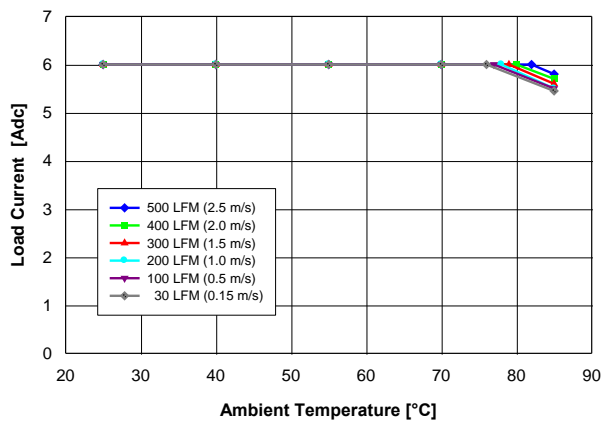

Fig. 1.5V.1: Available load current vs. ambient temperature and airflow rates for $V_{out} = 1.5V$ converter mounted vertically or horizontally with $V_{in} = 5V$, air flowing from pin 5 to pin 1, and maximum MOSFET temperature $\leq 120^\circ C$.

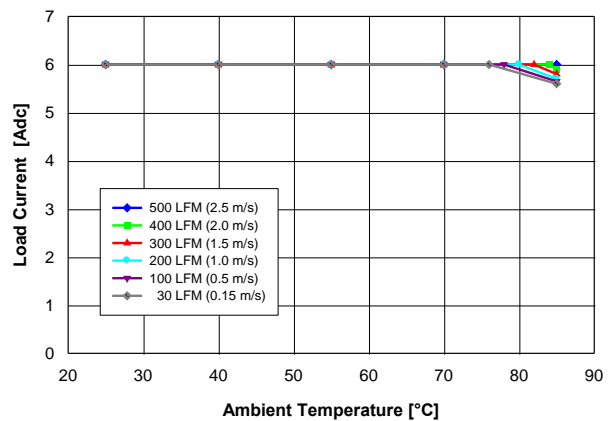

Fig. 1.5V.2: Available load current vs. ambient temperature and airflow rates for $V_{out} = 1.5V$ converter mounted vertically or horizontally with $V_{in} = 3.3V$, air flowing from pin 5 to pin 1, and maximum MOSFET temperature $\leq 120^\circ C$.

YNV05T06 DC-DC Converter

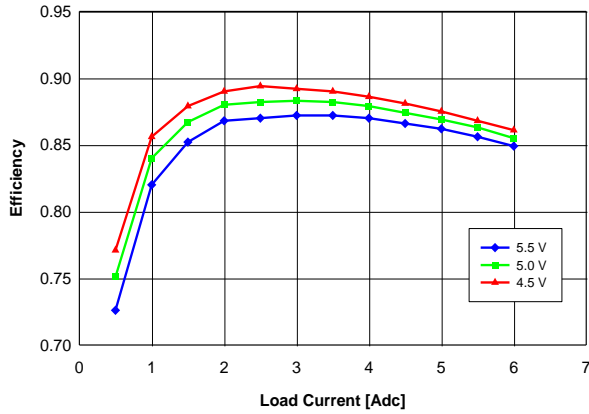

Fig. 1.5V.3: Efficiency vs. load current and input voltage for $V_{out} = 1.5V$ converter mounted vertically or horizontally with air flowing from pin 5 to pin 1 at a rate of 200 LFM (1 m/s) and $T_a = 25^\circ C$.

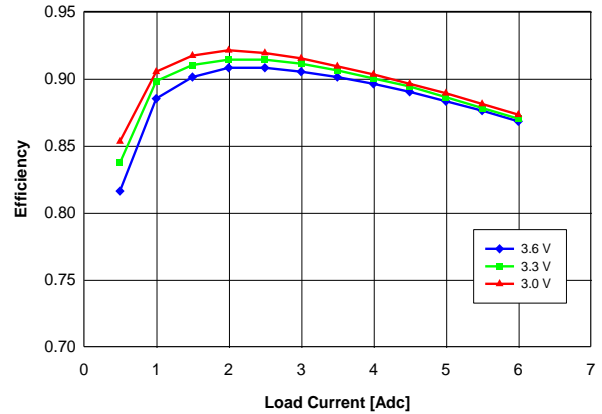

Fig. 1.5V.4: Efficiency vs. load current and input voltage for $V_{out} = 1.5V$ converter mounted vertically or horizontally with air flowing from pin 5 to pin 1 at a rate of 200 LFM (1 m/s) and $T_a = 25^\circ C$.

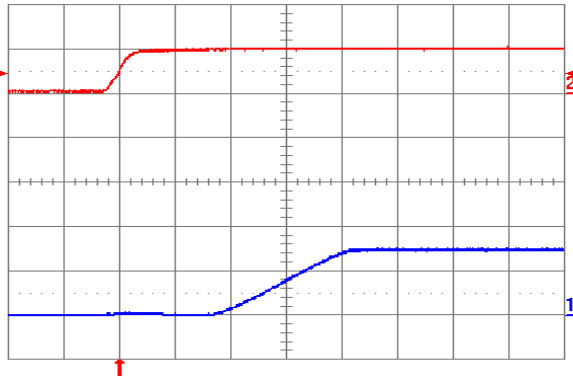

Fig. 1.5V.5: Turn-on transient for $V_{out} = 1.5V$ with application of V_{in} at full rated load current (resistive) and $47\mu F$ external capacitance at $V_{in} = 5V$. Top trace: V_{in} (5V/div.); Bottom trace: output voltage (1V/div.); Time scale: 2ms/div.

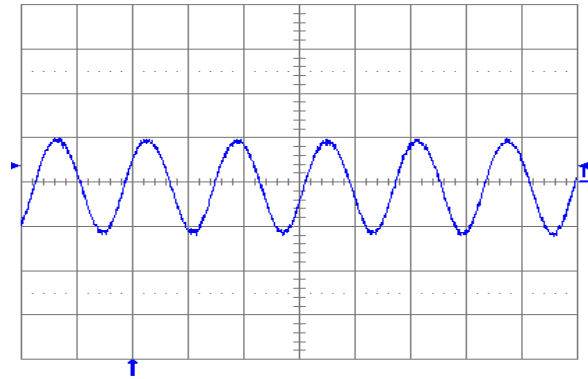

Fig. 1.5V.6: Output voltage ripple (20mV/div.) at full rated load current into a resistive load with external capacitance $47\mu F$ ceramic + $1\mu F$ ceramic and $V_{in} = 5V$ for $V_{out} = 1.5V$. Time scale: $2\mu s$ /div.

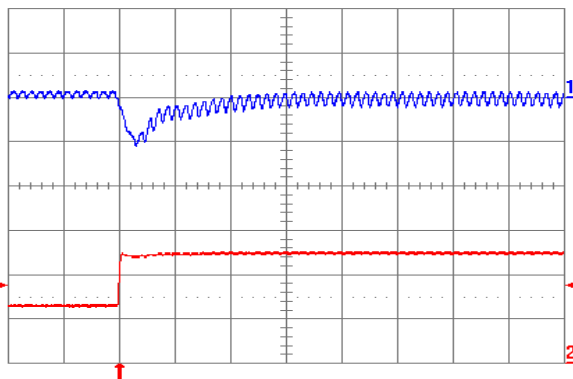

Fig. 1.5V.7: Output voltage response for $V_{out} = 1.5V$ to positive load current step change from 2.5A to 5A with slew rate of $5A/\mu s$ at $V_{in} = 5V$. Top trace: output voltage (100mV/div.); Bottom trace: load current (2A/div.). $C_o = 47\mu F$ ceramic. Time scale: $20\mu s$ /div.

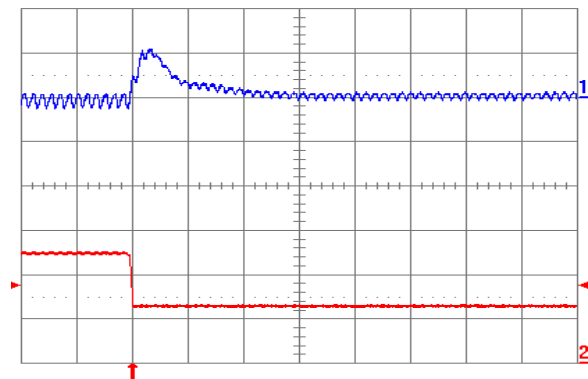

Fig. 1.5V.8: Output voltage response for $V_{out} = 1.5V$ to negative load current step change from 5A to 2.5A with slew rate of $-5A/\mu s$ at $V_{in} = 5V$. Top trace: output voltage (100mV/div.); Bottom trace: load current (2A/div.). $C_o = 47\mu F$ ceramic. Time scale: $20\mu s$ /div.

YNV05T06 DC-DC Converter

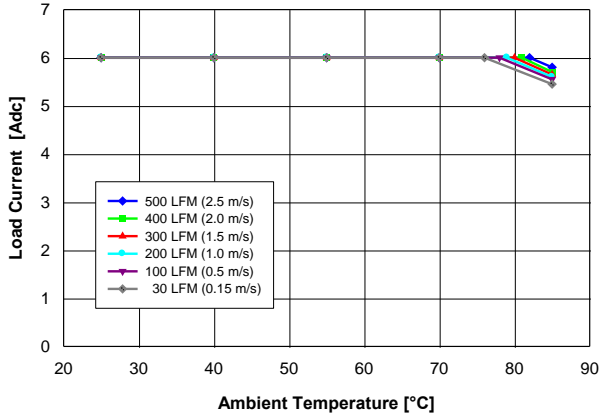

Fig. 1.2V.1: Available load current vs. ambient temperature and airflow rates for $V_{out} = 1.2V$ converter mounted vertically or horizontally with $V_{in} = 5V$, air flowing from pin 5 to pin 1, and maximum MOSFET temperature $\leq 120^{\circ}C$.

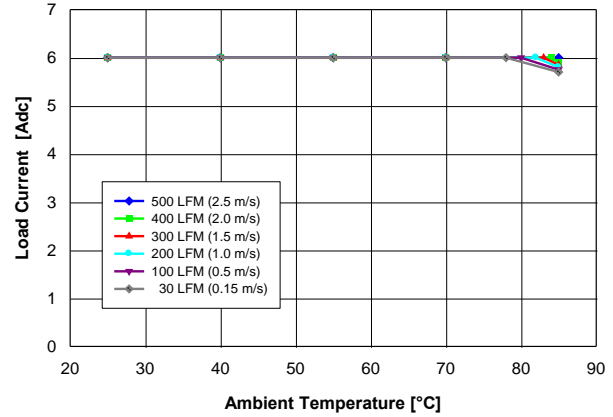

Fig. 1.2V.2: Available load current vs. ambient temperature and airflow rates for $V_{out} = 1.2V$ converter mounted vertically or horizontally with $V_{in} = 3.3V$, air flowing from pin 5 to pin 1, and maximum MOSFET temperature $\leq 120^{\circ}C$.

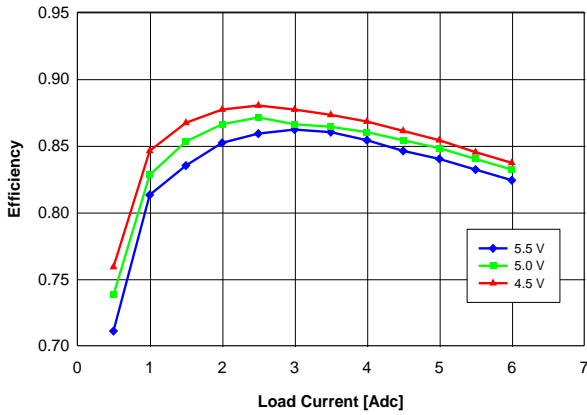

Fig. 1.2V.3: Efficiency vs. load current and input voltage for $V_{out} = 1.2V$ converter mounted vertically or horizontally with air flowing from pin 5 to pin 1 at a rate of 200 LFM (1 m/s) and $T_a = 25^{\circ}C$.

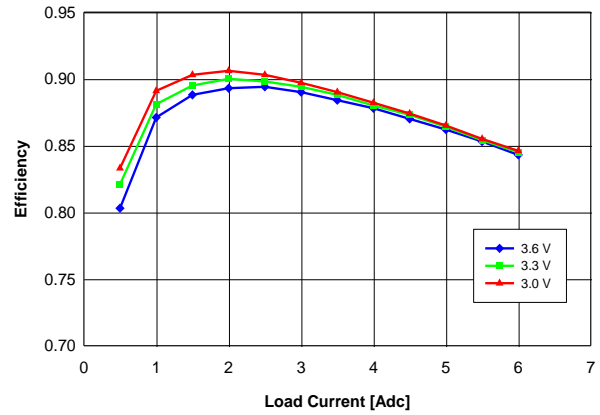

Fig. 1.2V.4: Efficiency vs. load current and input voltage for $V_{out} = 1.2V$ converter mounted vertically or horizontally with air flowing from pin 5 to pin 1 at a rate of 200 LFM (1 m/s) and $T_a = 25^{\circ}C$.

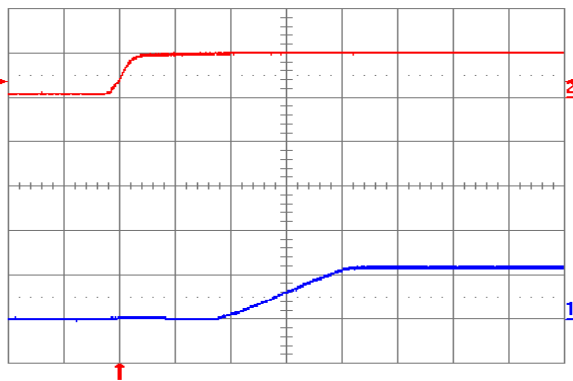

Fig. 1.2V.5: Turn-on transient for $V_{out} = 1.2V$ with application of V_{in} at full rated load current (resistive) and $47\mu F$ external capacitance at $V_{in} = 5V$. Top trace: V_{in} (5V/div.); Bottom trace: output voltage (1V/div.); Time scale: 2ms/div.

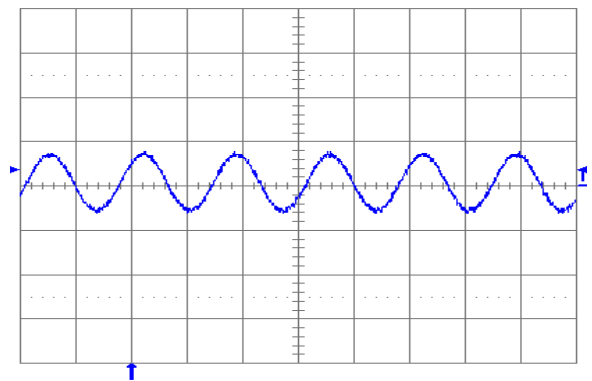

Fig. 1.2V.6: Output voltage ripple (20mV/div.) at full rated load current into a resistive load with external capacitance $47\mu F$ ceramic + $1\mu F$ ceramic and $V_{in} = 5V$ for $V_{out} = 1.2V$. Time scale: 2 μs /div.

YNV05T06 DC-DC Converter

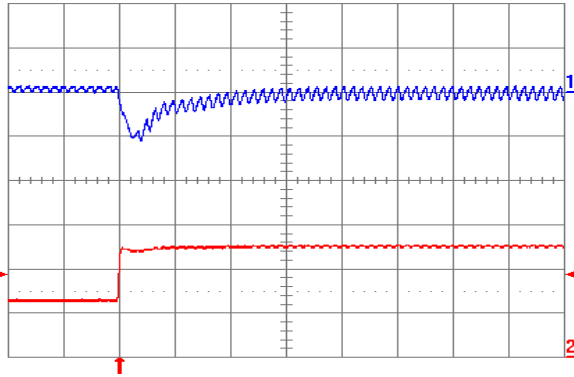

Fig. 1.2V.7: Output voltage response for $V_{out} = 1.2V$ to positive load current step change from 2.5A to 5A with slew rate of $5A/\mu s$ at $V_{in} = 5V$. Top trace: output voltage (100mV/div.); Bottom trace: load current (2A/div.). $C_o = 47\mu F$ ceramic. Time scale: $20\mu s/div$.

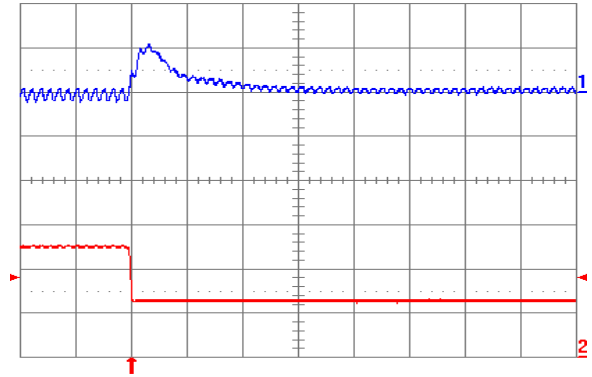

Fig. 1.2V.8: Output voltage response for $V_{out} = 1.2V$ to negative load current step change from 5A to 2.5A with slew rate of $-5A/\mu s$ at $V_{in} = 5V$. Top trace: output voltage (100mV/div.); Bottom trace: load current (2A/div.). $C_o = 47\mu F$ ceramic. Time scale: $20\mu s/div$.

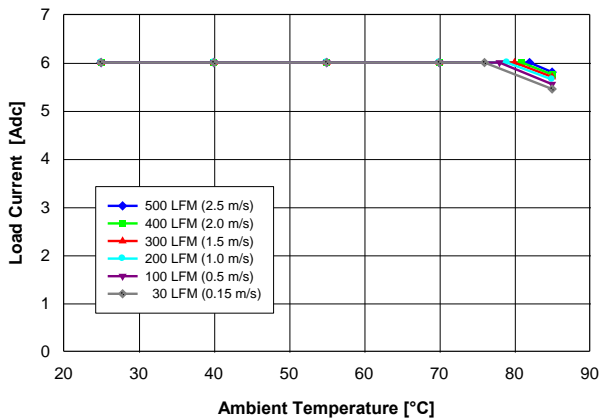

Fig. 1.0V.1: Available load current vs. ambient temperature and airflow rates for $V_{out} = 1.0V$ converter mounted vertically or horizontally with $V_{in} = 5V$, air flowing from pin 5 to pin 1, and maximum MOSFET temperature $\leq 120^\circ C$.

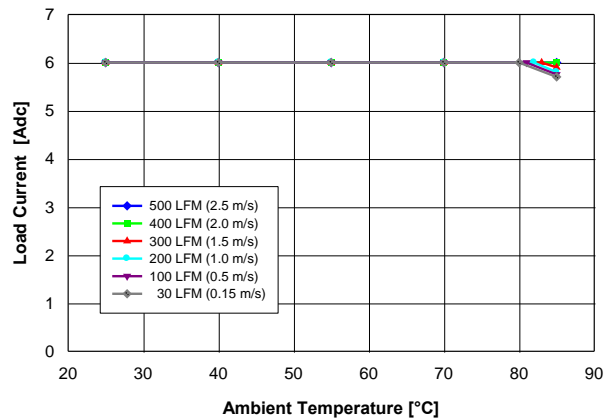

Fig. 1.0V.2: Available load current vs. ambient temperature and airflow rates for $V_{out} = 1.0V$ converter mounted vertically or horizontally with $V_{in} = 3.3V$, air flowing from pin 5 to pin 1, and maximum MOSFET temperature $\leq 120^\circ C$.

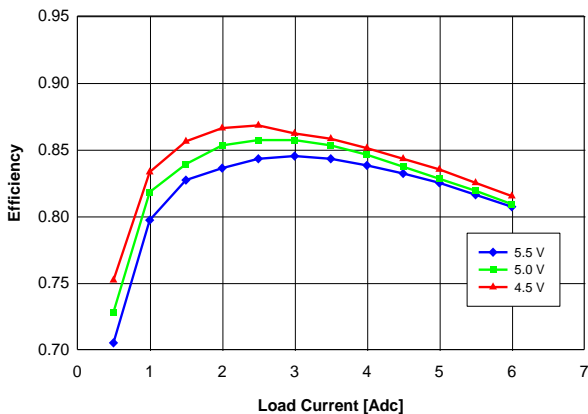

Fig. 1.0V.3: Efficiency vs. load current and input voltage for $V_{out} = 1.0V$ converter mounted vertically or horizontally with air flowing from pin 5 to pin 1 at a rate of 200 LFM (1 m/s) and $T_a = 25^\circ C$.

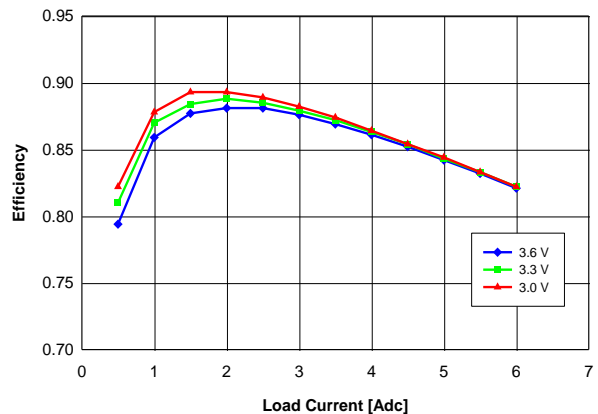

Fig. 1.0V.4: Efficiency vs. load current and input voltage for $V_{out} = 1.0V$ converter mounted vertically or horizontally with air flowing from pin 5 to pin 1 at a rate of 200 LFM (1 m/s) and $T_a = 25^\circ C$.

YNV05T06 DC-DC Converter

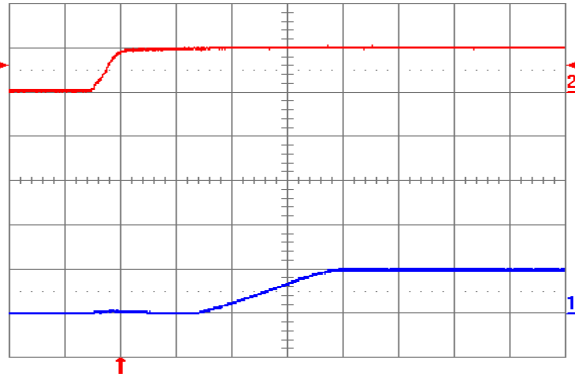

Fig. 1.0V.5: Turn-on transient for $V_{out} = 1.0V$ with application of V_{in} at full rated load current (resistive) and $47\mu F$ external capacitance at $V_{in} = 5V$. Top trace: V_{in} (5V/div.); Bottom trace: output voltage (1V/div.); Time scale: 2ms/div.

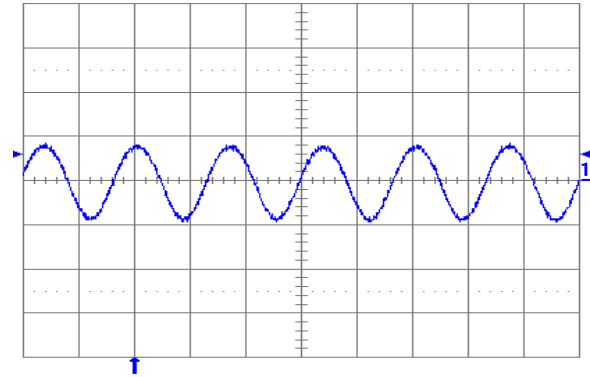

Fig. 1.0V.6: Output voltage ripple (20mV/div.) at full rated load current into a resistive load with external capacitance $47\mu F$ ceramic + $1\mu F$ ceramic and $V_{in} = 5V$ for $V_{out} = 1.0V$. Time scale: $2\mu s$ /div.

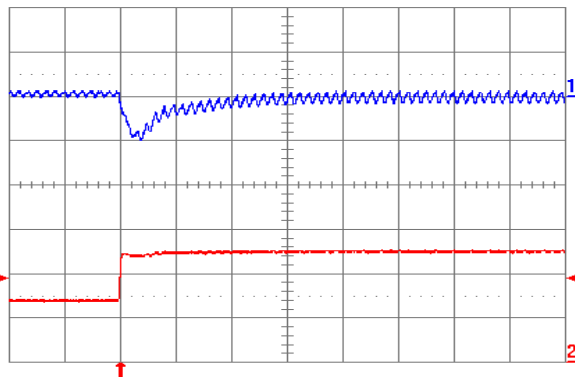

Fig. 1.0V.7: Output voltage response for $V_{out} = 1.0V$ to positive load current step change from 2.5A to 5A with slew rate of $5A/\mu s$ at $V_{in} = 5V$. Top trace: output voltage (100mV/div.); Bottom trace: load current (2A/div.). $C_o = 47\mu F$ ceramic. Time scale: $20\mu s$ /div.

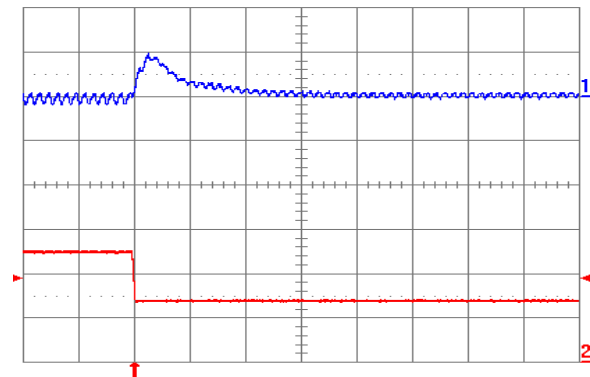

Fig. 1.0V.8: Output voltage response for $V_{out} = 1.0V$ to negative load current step change from 5A to 2.5A with slew rate of $-5A/\mu s$ at $V_{in} = 5V$. Top trace: output voltage (100mV/div.); Bottom trace: load current (2A/div.). $C_o = 47\mu F$ ceramic. Time scale: $20\mu s$ /div.

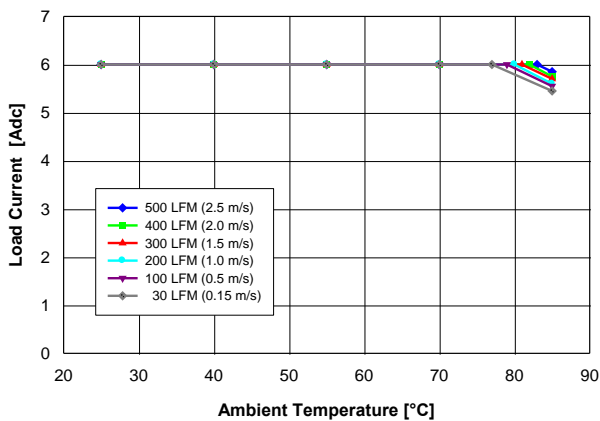

Fig. 0.7525V.1: Available load current vs. ambient temperature and airflow rates for $V_{out} = 0.7525V$ converter mounted vertically or horizontally with $V_{in} = 5V$, air flowing from pin 5 to pin 1, and maximum MOSFET temperature $\leq 120^\circ C$.

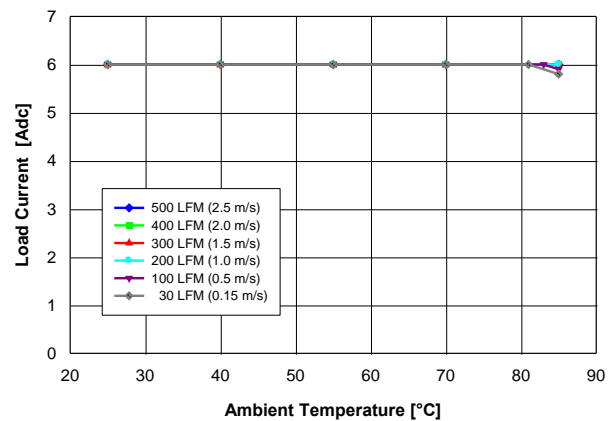

Fig. 0.7525V.2: Available load current vs. ambient temperature and airflow rates for $V_{out} = 0.7525V$ converter mounted vertically or horizontally with $V_{in} = 3.3V$, air flowing from pin 5 to pin 1, and maximum MOSFET temperature $\leq 120^\circ C$.

YNV05T06 DC-DC Converter

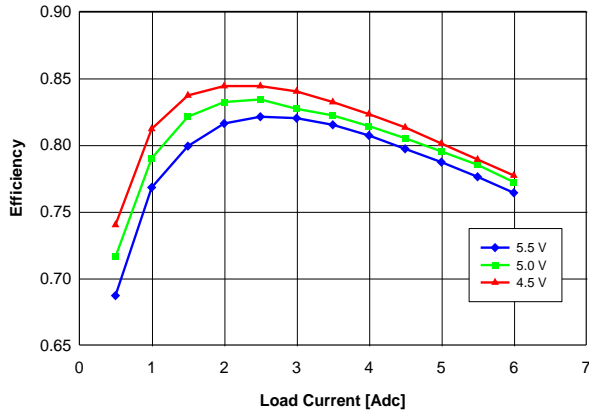

Fig. 0.7525V.3: Efficiency vs. load current and input voltage for $V_{out} = 0.7525V$ converter mounted vertically or horizontally with air flowing from pin 5 to pin 1 at a rate of 200 LFM (1 m/s) and $T_a = 25^{\circ}C$.

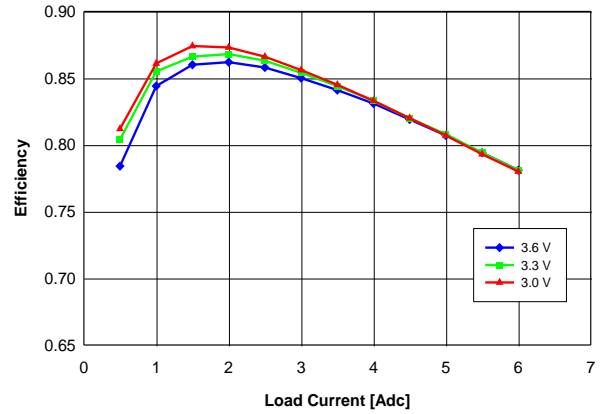

Fig. 0.7525V.4: Efficiency vs. load current and input voltage for $V_{out} = 0.7525V$ converter mounted vertically or horizontally with air flowing from pin 5 to pin 1 at a rate of 200 LFM (1 m/s) and $T_a = 25^{\circ}C$.

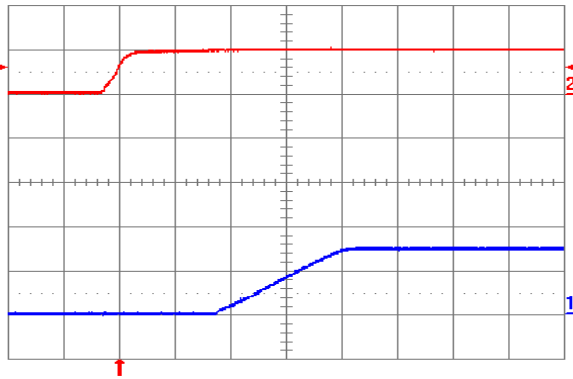

Fig. 0.7525V.5: Turn-on transient for $V_{out} = 0.7525V$ with application of V_{in} at full rated load current (resistive) and $47\mu F$ external capacitance at $V_{in} = 5V$. Top trace: V_{in} (5V/div.); Bottom trace: output voltage (1V/div.); Time scale: 2ms/div.

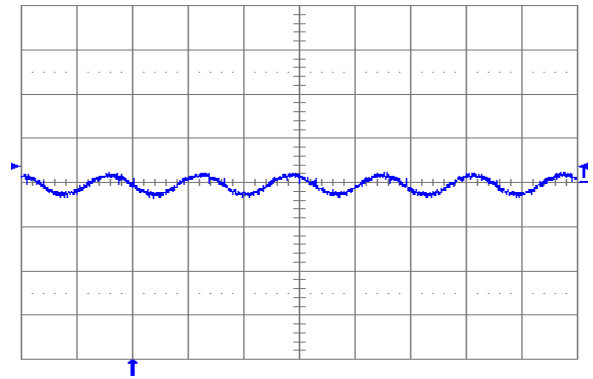

Fig. 0.7525V.6: Output voltage ripple (20mV/div.) at full rated load current into a resistive load with external capacitance $47\mu F$ ceramic + $1\mu F$ ceramic and $V_{in} = 5V$ for $V_{out} = 0.7525V$. Time scale: 2μs/div.

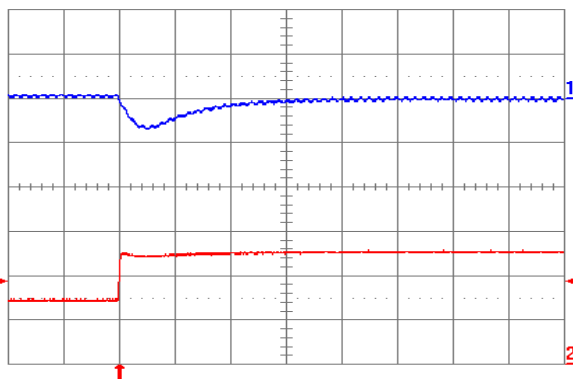

Fig. 0.7525V.7: Output voltage response for $V_{out} = 0.7525V$ to positive load current step change from 2.5A to 5A with slew rate of $5A/\mu s$ at $V_{in} = 5V$. Top trace: output voltage (100mV/div.); Bottom trace: load current (2A/div.). $C_o = 47\mu F$ ceramic. Time scale: 20μs/div.

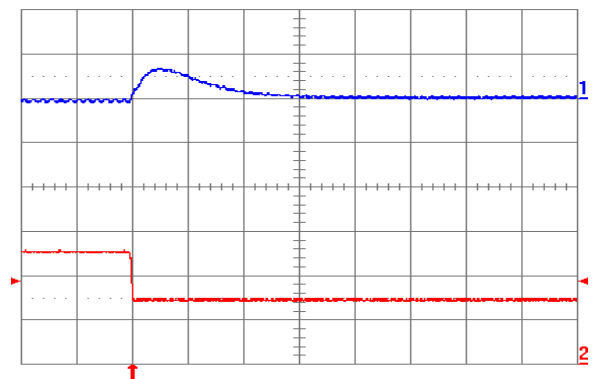
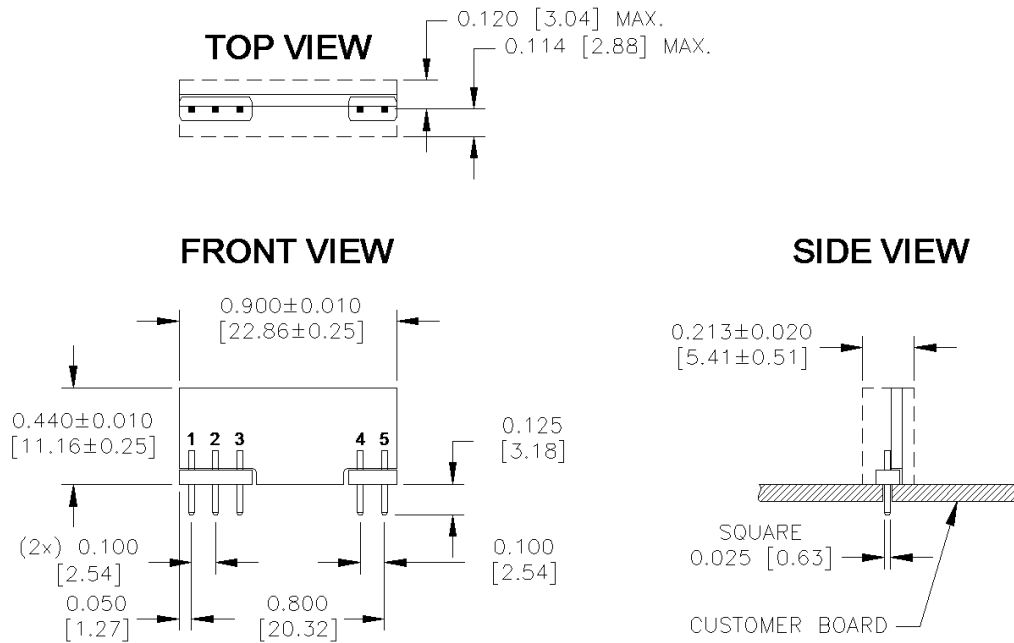

Fig. 0.7525V.8: Output voltage response for $V_{out} = 0.7525V$ to negative load current step change from 5A to 2.5A with slew rate of $-5A/\mu s$ at $V_{in} = 5V$. Top trace: output voltage (100mV/div.); Bottom trace: load current (2A/div.). $C_o = 47\mu F$ ceramic. Time scale: 20μs/div.

YNV05T06 DC-DC Converter

Physical Information



YNV05T06 Pinout (Through-Hole - SIP)

PAD/PIN CONNECTIONS	
Pad/Pin #	Function
1	Vout
2	TRIM
3	GND
4	Vin
5	ON/OFF

YNV05T06 Platform Notes

- All dimensions are in inches [mm]
- Connector Material: Copper
- Connector Finish: Tin
- Converter Weight: 0.08 oz [2.22 g]
- Converter Height: 0.45" Max.
- Recommended Through Hole Via/Pad:
Min. 0.043" X 0.064" [1.09 x 1.63]

Ordering Information

Product Series	Input Voltage	Mounting Scheme	Rated Load Current	Environmental
YNV	05	T	06	-
Y-Series	3.0 – 5.5 V	T ⇒ Through-Hole (SIP)	6 A (0.7525 V to 3.63 V)	No Suffix ⇒ RoHS lead-solder-exempt compliant G ⇒ RoHS compliant for all six substances

The example above describes P/N YNV05T06: 3.0V – 5.5V input, through-hole (SIP), 6A at 0.7525V to 3.63V output, and the RoHS lead-solder-exemption feature. Please consult factory regarding availability of a specific version.

For more information on these products consult: tech.support@psbel.com

NUCLEAR AND MEDICAL APPLICATIONS - Products are not designed or intended for use as critical components in life support systems, equipment used in hazardous environments, or nuclear control systems.

TECHNICAL REVISIONS - The appearance of products, including safety agency certifications pictured on labels, may change depending on the date manufactured. Specifications are subject to change without notice.