



Noise Absorber

Controlled ESR Type

YNA series

YNA15 type

YNA15

1005 [0402 inch]*

* Dimensions code JIS[EIA]

REMINDERS FOR USING THESE PRODUCTS

Before using these products, be sure to request the delivery specifications.

SAFETY REMINDERS

Please pay sufficient attention to the warnings for safe designing when using these products.

REMINDERS

- Do not use or store in locations where there are conditions such as gas corrosion (salt, acid, alkali, etc.).
- Before soldering, be sure to preheat components.
The preheating temperature should be set so that the temperature difference between the solder temperature and product temperature does not exceed 150°C.
- Soldering corrections after mounting should be within the range of the conditions determined in the specifications.
If overheated, a short circuit, performance deterioration, or lifespan shortening may occur.
- Self heating (temperature increase) occurs when the power is turned ON, so the tolerance should be sufficient for the set thermal design.
- Do not use for a purpose outside of the contents regulated in the delivery specifications.

- The products listed on this catalog are intended for use in general electronic equipment (AV equipment, telecommunications equipment, home appliances, amusement equipment, computer equipment, personal equipment, office equipment, measurement equipment, industrial robots) under a normal operation and use condition.

The products are not designed or warranted to meet the requirements of the applications listed below, whose performance and/or quality require a more stringent level of safety or reliability, or whose failure, malfunction or trouble could cause serious damage to society, person or property.

If you intend to use the products in the applications listed below or if you have special requirements exceeding the range or conditions set forth in the each catalog, please contact us.

- | | |
|---|--|
| (1) Aerospace/Aviation equipment | (8) Public information-processing equipment |
| (2) Transportation equipment (cars, electric trains, ships, etc.) | (9) Military equipment |
| (3) Medical equipment | (10) Electric heating apparatus, burning equipment |
| (4) Power-generation control equipment | (11) Disaster prevention/crime prevention equipment |
| (5) Atomic energy-related equipment | (12) Safety equipment |
| (6) Seabed equipment | (13) Other applications that are not considered general-purpose applications |
| (7) Transportation control equipment | |

When designing your equipment even for general-purpose applications, you are kindly requested to take into consideration securing protection circuit/device or providing backup circuits in your equipment.

Noise Absorber

Controlled ESR Type

Product compatible with RoHS directive
Lead-free compatible

Overview of YNA15 type

FEATURES

- The special laminated interior structure means ESR values can be controlled.
- An impedance waveform with no pole means anti-resonance is controlled.
- Without decreasing power efficiency, EMI measures can be taken.

APPLICATION

Countermeasures against ringing of switching power supply for smart phones, tablet PCs, etc.
Countermeasures against anti-resonance of impedance inside a decoupling circuit

PART NUMBER CONSTRUCTION

YNA	15	B	1J	0G	105	M	T	□□	0	N					
Series name	L x W dimensions (mm)	Product internal code		ESR-value* (mΩ)		Rated voltage (V)		Capacitance (pF)		Tolerance	Taping	internal-code	Reel size (mm)		Internal electrode Ni
	15 1.0×0.5	B	2-terminal (with NC terminal) (NC:Not Connected)		1J 50 2A 100 2C 200 2J 500 3A 1,000	0G 4		105	1,000,000 (1.0μF)	M ±20%			0 ø178 9 ø330		

* An ESR value is shown in two characters with a mΩ unit.

OPERATING TEMPERATURE RANGE

Type	Temperature(°C)	
	Operating temperature range	Storage temperature range (After mount)
YNA15	-55 to +85	-55 to +85

PACKAGING STYLE AND SPECIFICATIONS

Type	Package quantity (piece/reel)		Individual weight (g)
	ø178	ø330	
YNA15	10,000	50,000	0.0008

○ RoHS Directive Compliant Product: See the following for more details.<https://product.tdk.com/info/en/environment/rohs/index.html>

 Please be sure to request delivery specifications that provide further details on the features and specifications of the products for proper and safe use.
Please note that the contents may change without any prior notice due to reasons such as upgrading.

YNA15 type

RECOMMENDED SOLDERING CONDITION

REFLOW SOLDERING

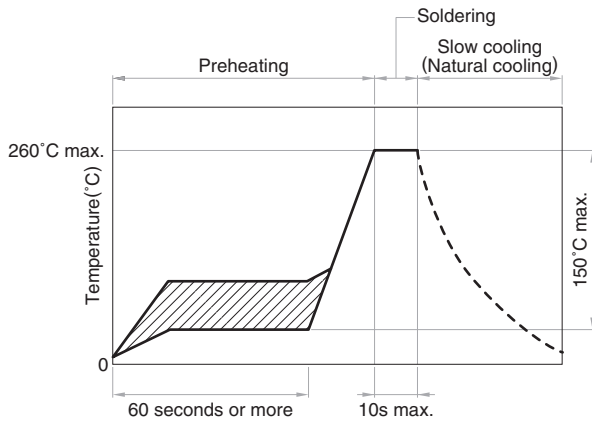

HAND SOLDERING

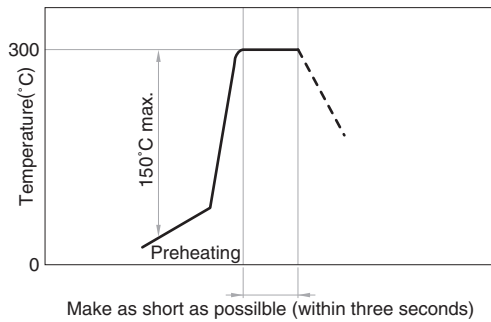

REMINDERS FOR HANDLING THESE PRODUCTS

- Before soldering, be sure to preheat components. The ΔT preheating temperature must be 150°C max. with attention paid to thermal shock.
- Natural cooling of components in the air is recommended. On the other hand, when dipping them in a solvent for purposes, such as cleaning, make sure that the temperature difference (ΔT) is 100°C.
- When performing hand soldering for circuit modification, apply the soldering iron to the copper foil area of the printed circuit board for 3 seconds or less. The temperature of the iron tip should not exceed 300°C.
- Use a wrist band to discharge static electricity in your body through the grounding wire.
- When incorporating the printed circuit board on which this product is mounted into a frame, etc., do not apply stress to the product through local bending of the board by tightening of screws, etc.

YNA15 type

SHAPE & DIMENSIONS

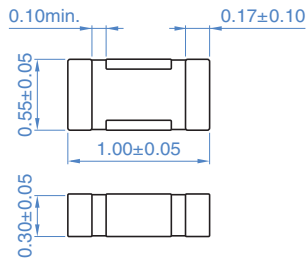

RECOMMENDED LAND PATTERN

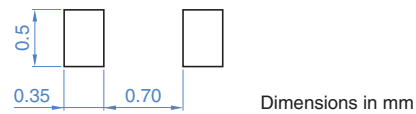

The lateral terminals are not connected.

ELECTRICAL CHARACTERISTICS

CHARACTERISTICS SPECIFICATION TABLE

Part No.*	Capacitance (μF)	Tolerance (%)	Rated voltage Edc (V)	ESR** (mΩ)
YNA15B1J0G105MT00□N	1	20	4	50 (±30%)
YNA15B2A0G105MT00□N	1	20	4	100 (±30%)
YNA15B2C0G105MT00□N	1	20	4	200 (±30%)
YNA15B2J0G105MT00□N	1	20	4	500 (±30%)
YNA15B3A0G105MT00□N	1	20	4	1000 (±30%)

* □: Please specify reel size code, 0 (ø178) or 9 (ø330)

** Any ESR value can be set if it is the same as or smaller than the maximum ESR value. Contact us if you need an ESR value other than ones shown in the table.

ELECTRICAL CHARACTERISTICS GRAPH (EXAMPLE)

IMPEDANCE vs. FREQUENCY CHARACTERISTICS

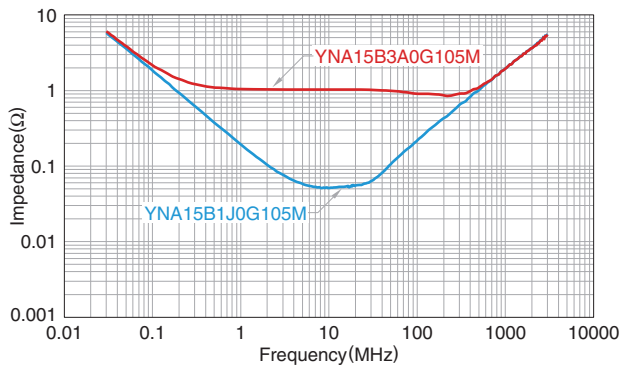

ATTENUATION vs. FREQUENCY CHARACTERISTICS

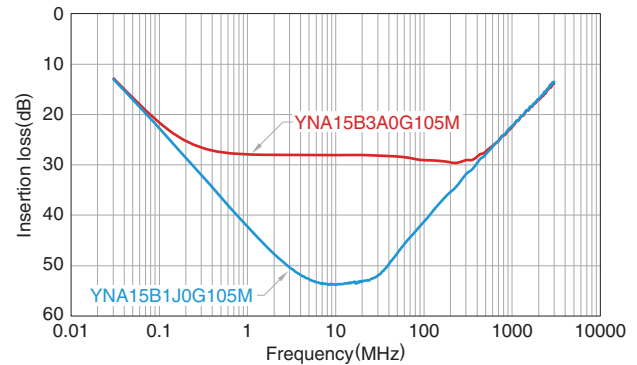

YNA15 type

PACKAGING STYLES

REEL DIMENSIONS

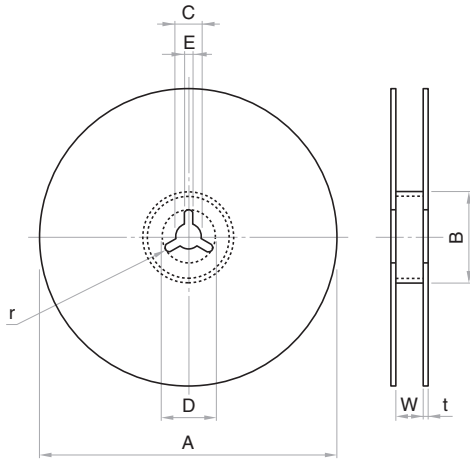

Unit: mm

Reel	A	B	C	D	E	W	t	r
ø178	ø178±2.0	ø60±2.0	ø13±0.5	ø21±0.8	2.0±0.5	9.0±0.3	2.0±0.5	1.0
ø330	ø382 max.(ø330 nom.)	ø50 min.	ø13±0.5	ø21±0.8	2.0±0.5	10.0±1.5	2.0±0.5	1.0

TAPE DIMENSIONS

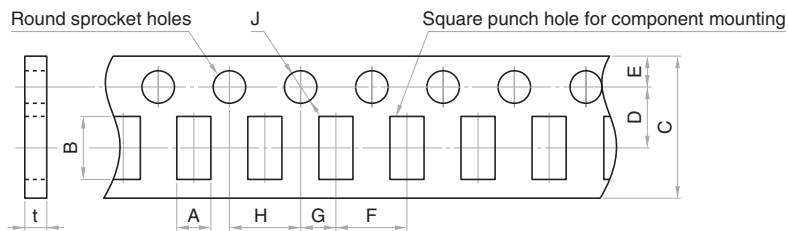

Unit: mm

Type	A	B	C	D	E	F	G	H	J	t
YNA15	0.65 typ.	1.15 typ.	8.00±0.30	3.50±0.05	1.75±0.10	2.00±0.05	2.00±0.05	4.00±0.10	ø1.50+0.10/-0	0.70 max.