



Multilayer Triplexer

For 1560-1606MHz / 2400-2500MHz / 4900-5950MHz

TPX205950MT-7110A1

2.0x1.25mm [EIA 0805]*

* Dimensions Code JIS[EIA]

Multilayer Triplexer

Conformity to RoHS Directive

For 1560-1606MHz / 2400-2500MHz / 4900-5950MHz

TPX205950MT-7110A1

SHAPES AND DIMENSIONS

[Top view]

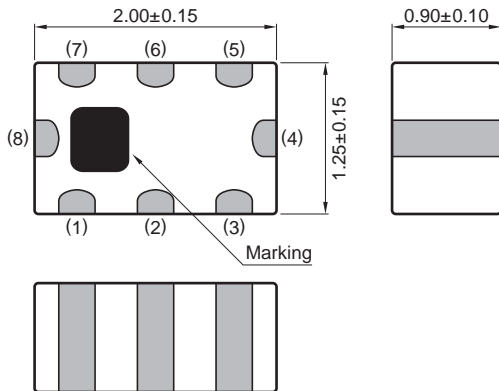

[Bottom view]

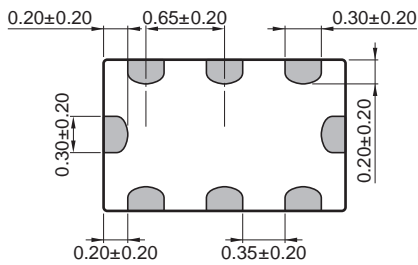

Terminal functions

1	GND
2	Common port
3	GND
4	Low-band port
5	GND
6	High-band port
7	GND
8	Middle-band port

Dimensions in mm

RECOMMENDED LAND PATTERN

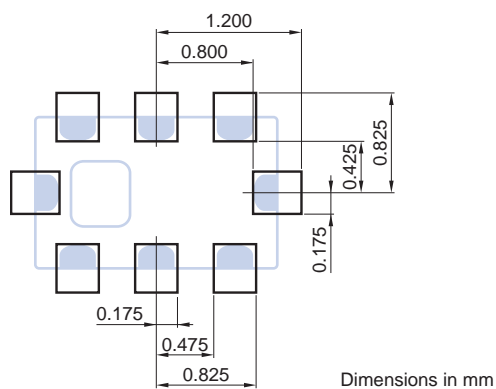

Dimensions in mm

EVALUATION BOARD

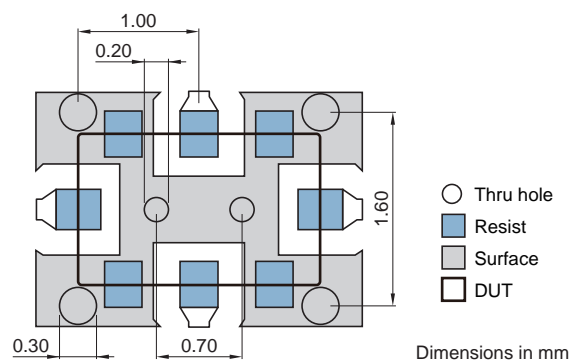

Dimensions in mm

Material, Layer	Thickness
Top Resist	Resist
Copper Surface Pattern	0.035mm
FR-4	0.10mm
Copper Inner GND	0.018mm
FR-4	0.30mm
Copper Bottom GND	0.035mm

Line width should be designed to match 50Ω characteristic impedance, depending on PCB material and thickness.

RoHS Directive Compliant Product: See the following for more details. <https://product.tdk.com/info/en/environment/rohs/index.html>

- All specifications are subject to change without notice.
- Before using these products, be sure to request the delivery specifications.

TPX205950MT-7110A1

ELECTRICAL CHARACTERISTICS

LOW-BAND

Item	Frequency Range (MHz)	Min.	Typ.	Max.
Insertion Loss (dB)	1560 to 1606	—	0.38	0.60
	1560 to 1606	—	0.46	0.70 (−40 to +85°C)
Return Loss (dB)	1560 to 1606	9.54	20	—
	2400 to 2500	14	17	—
Attenuation (dB)	4800 to 6000	15	21	—
	2400 to 2500	13	17	—
	4800 to 6000	15	21	—
Characteristic Impedance (Ω)			50 (Nominal)	

· Ta: +25±5°C

MIDDLE-BAND

Item	Frequency Range (MHz)	Min.	Typ.	Max.
Insertion Loss (dB)	2400 to 2500	—	0.62	0.73
	2400 to 2500	—	0.68	0.81 (−40 to +85°C)
Return Loss (dB)	2400 to 2500	9.54	13	—
	860 to 960	10	12	—
	1545 to 1605	13	18	—
	3600 to 3750	8	11	—
	4800 to 5000	20	34	—
	7200 to 7500	10	25	—
Attenuation (dB)	9600 to 10000	5	13	—
	860 to 960	10	12	— (−40 to +85°C)
	1545 to 1605	13	18	— (−40 to +85°C)
	3600 to 3750	8	10	— (−40 to +85°C)
	4800 to 5000	20	33	— (−40 to +85°C)
	7200 to 7500	10	26	— (−40 to +85°C)
	9600 to 10000	5	15	— (−40 to +85°C)
	9600 to 10000	5	15	— (−40 to +85°C)
Characteristic Impedance (Ω)			50 (Nominal)	

· Ta: +25±5°C

HIGH-BAND

Item	Frequency Range (MHz)	Min.	Typ.	Max.
Insertion Loss (dB)	4900 to 5950	—	0.50	0.80
	4900 to 5950	—	0.60	0.92 (−40 to +85°C)
Return Loss (dB)	4900 to 5950	9.54	17	—
	860 to 960	24	26	—
	1545 to 1605	24	27	—
	1710 to 1990	25	28	—
	2170	30	32	—
	8820 to 9800	14	22	—
Attenuation (dB)	9800 to 11800	25	29	—
	860 to 960	24	26	— (−40 to +85°C)
	1545 to 1605	24	27	— (−40 to +85°C)
	1710 to 1990	25	28	— (−40 to +85°C)
	2170	30	33	— (−40 to +85°C)
	8820 to 9800	14	22	— (−40 to +85°C)
	9800 to 11800	22	28	— (−40 to +85°C)
	9800 to 11800	22	28	— (−40 to +85°C)
Characteristic Impedance (Ω)			50 (Nominal)	

· Ta: +25±5°C

- All specifications are subject to change without notice.
- Before using these products, be sure to request the delivery specifications.

TPX205950MT-7110A1

ELECTRICAL CHARACTERISTICS

COMMON

Item		Frequency Range (MHz)	Min.	Typ.	Max.
Isolation (dB)	Middle to High	4800 to 5000	20	29	—
	Middle to Low	1559 to 1606	15	21	—
	High to Low	1559 to 1606	24	27	—
Characteristic Impedance (Ω)				50 (Nominal)	

· Ta: +25±5°C

TEMPERATURE RANGE

Operating temperature (°C)	Storage temperature (°C)
-40 to +85	-40 to +85

- All specifications are subject to change without notice.
- Before using these products, be sure to request the delivery specifications.

TPX205950MT-7110A1

FREQUENCY CHARACTERISTICS

LOW-BAND

Insertion Loss

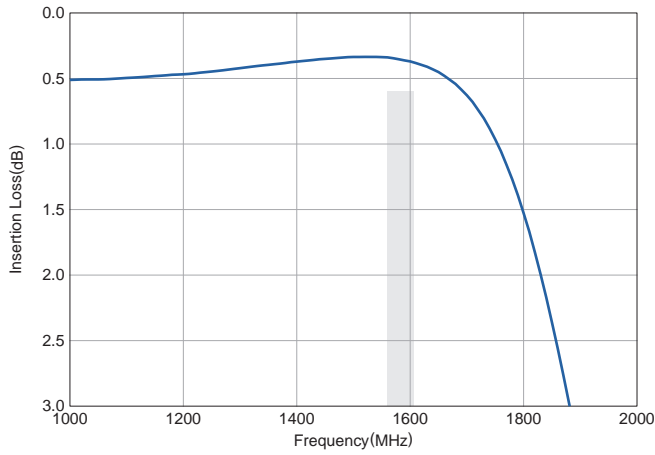

Return Loss

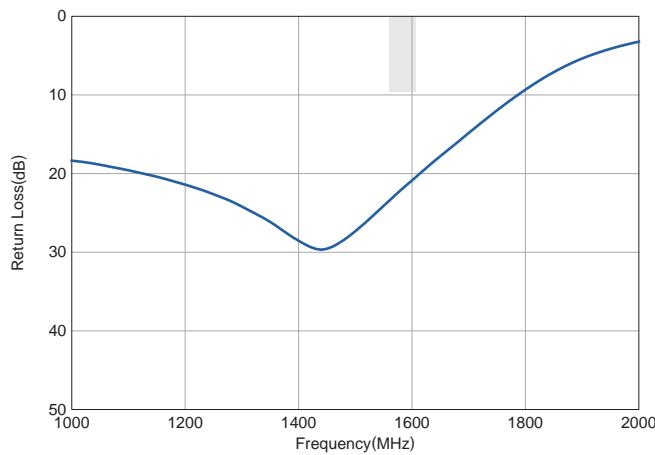

Attenuation

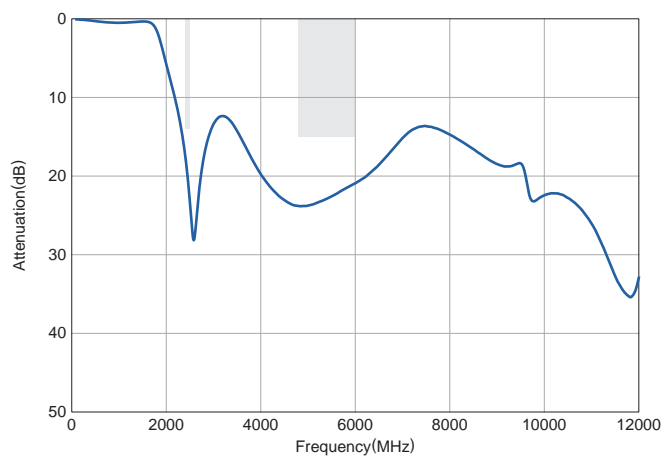

MIDDLE-BAND

Insertion Loss

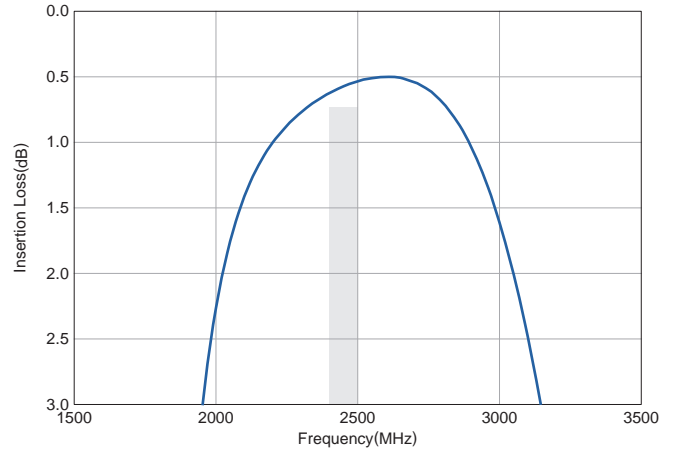

Return Loss

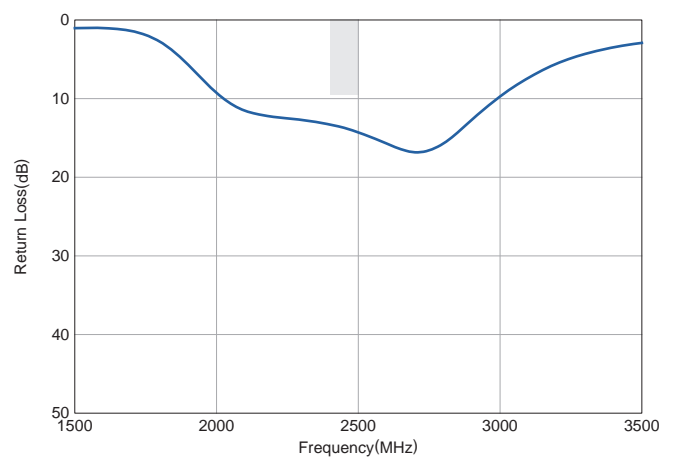

Attenuation

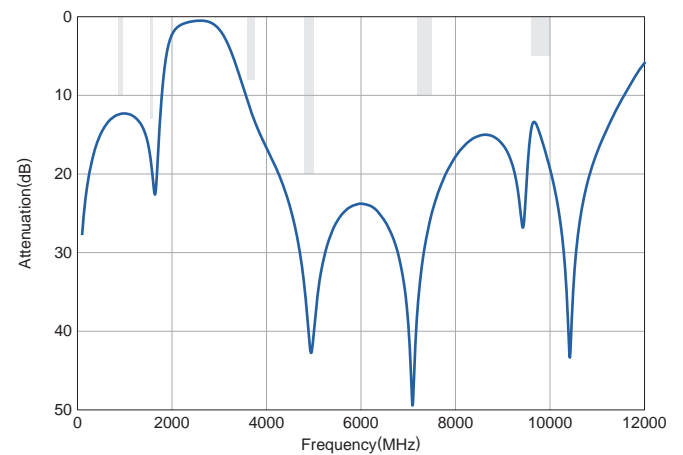

- All specifications are subject to change without notice.
- Before using these products, be sure to request the delivery specifications.

TPX205950MT-7110A1

FREQUENCY CHARACTERISTICS

HIGH-BAND

Insertion Loss

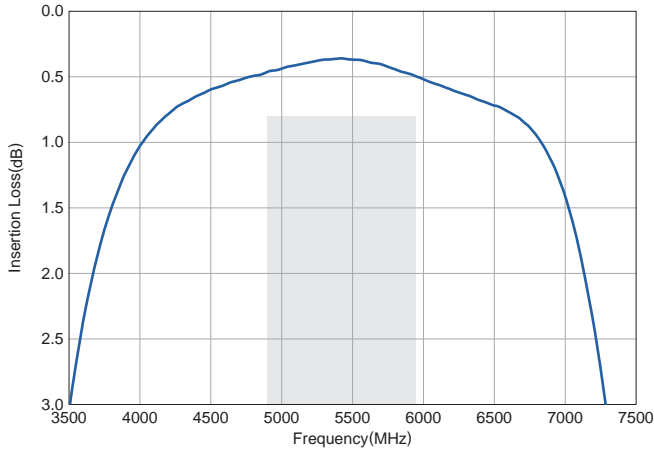

Return Loss

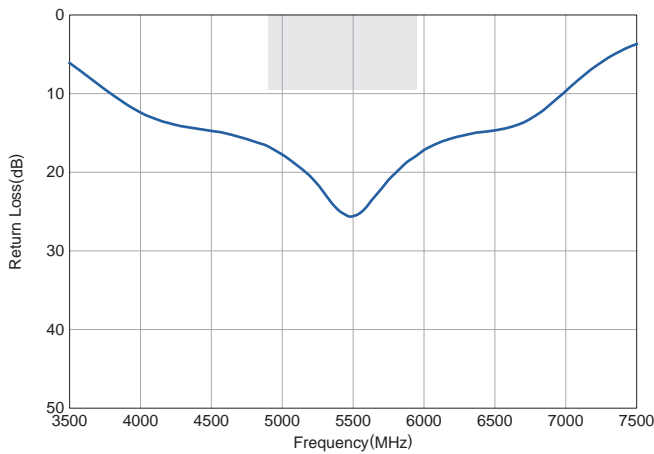

Attenuation

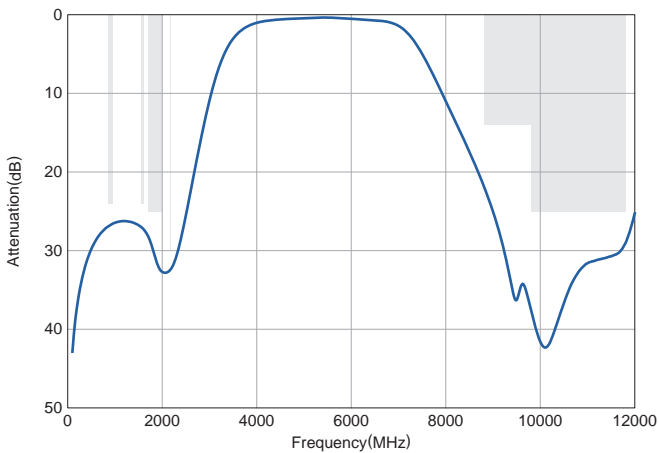

- All specifications are subject to change without notice.
- Before using these products, be sure to request the delivery specifications.

TPX205950MT-7110A1

FREQUENCY CHARACTERISTICS

COMMON

Return Loss

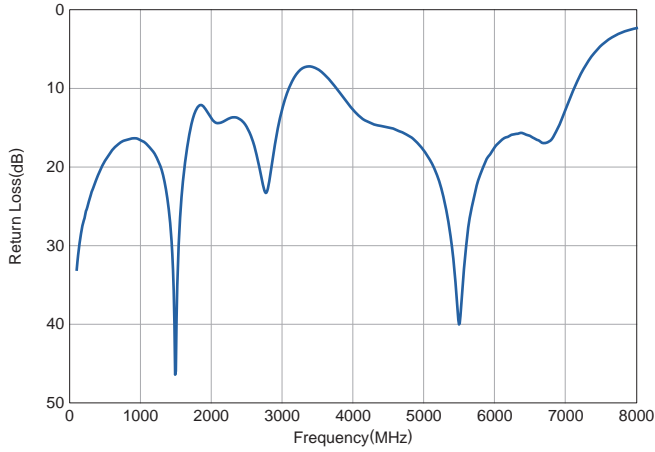

Isolation (Low-Mid)

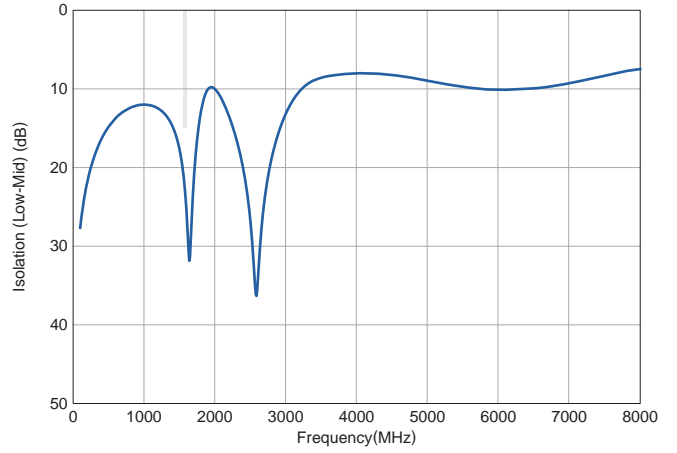

Isolation (Low-High)

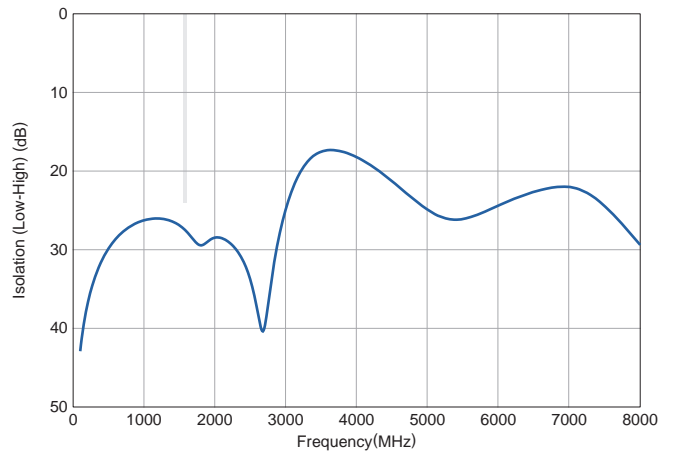

Isolation (Mid-High)

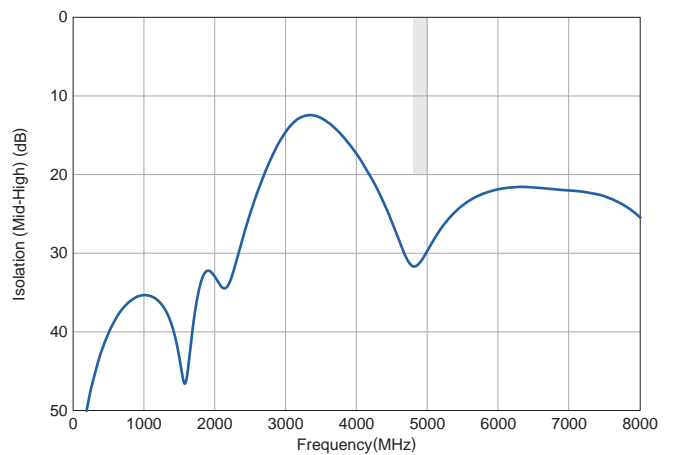

- All specifications are subject to change without notice.
- Before using these products, be sure to request the delivery specifications.

RECOMMENDED REFLOW PROFILE

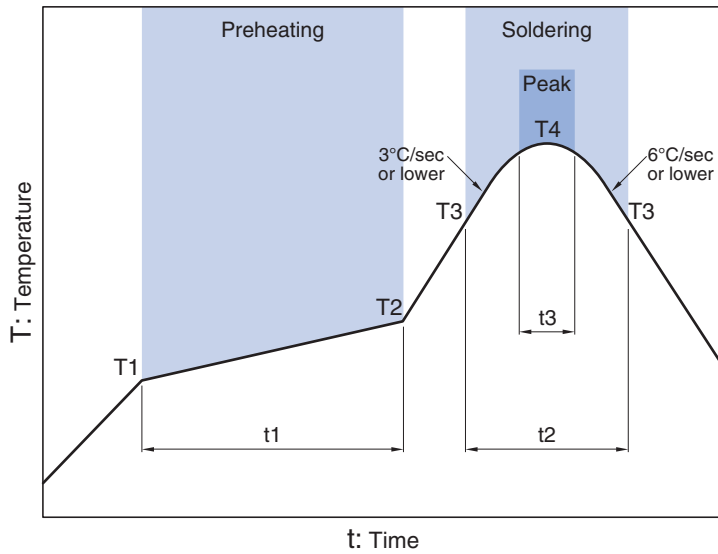

Preheating			Soldering			
Temp.	Time		Critical zone (T3 to T4)		Peak	
T1	T2	t1	T3	t2	T4	t3*
150°C	200°C	60 to 120sec	217°C	60 to 120sec	240 to 260°C	30sec max.

* t3 : Time within 5°C of actual peak temperature
 The maximum number of reflow is 3.

REMINDERS FOR USING THESE PRODUCTS

Before using these products, be sure to request the delivery specifications.

SAFETY REMINDERS

Please pay sufficient attention to the warnings for safe designing when using these products.

REMINDERS

The products listed on this catalog are intended for use in general electronic equipment (AV equipment, telecommunications equipment, home appliances, amusement equipment, computer equipment, personal equipment, office equipment, measurement equipment, industrial robots) under a normal operation and use condition.

The products are not designed or warranted to meet the requirements of the applications listed below, whose performance and/or quality require a more stringent level of safety or reliability, or whose failure, malfunction or trouble could cause serious damage to society, person or property.

Please understand that we are not responsible for any damage or liability caused by use of the products in any of the applications below or for any other use exceeding the range or conditions set forth in this catalog.

- | | |
|---|--|
| (1) Aerospace/Aviation equipment | (8) Public information-processing equipment |
| (2) Transportation equipment (cars, electric trains, ships, etc.) | (9) Military equipment |
| (3) Medical equipment | (10) Electric heating apparatus, burning equipment |
| (4) Power-generation control equipment | (11) Disaster prevention/crime prevention equipment |
| (5) Atomic energy-related equipment | (12) Safety equipment |
| (6) Seabed equipment | (13) Other applications that are not considered general-purpose applications |
| (7) Transportation control equipment | |

When using this product in general-purpose applications, you are kindly requested to take into consideration securing protection circuit/equipment or providing backup circuits, etc., to ensure higher safety.