

T493 Commercial Off-The-Shelf (COTS) MnO₂ (CWR11 Style)

Overview

The KEMET T493 Series is designed for the Commercial Off-The-Shelf (COTS) requirements of military and aerospace applications. This series is a surface mount product offering various lead-frame plating options, Weibull grading options, surge current testing, F-Tech (an improved anode manufacturing process) and Simulated Breakdown Voltage (SBDV) screening options to improve long term reliability. Standard, low, and ultra-low ESR options are available. All lots of this series are conditioned with MIL-PRF-55365 Group A testing. This series is also approved for DLA Drawing 07016 (please see part number list specific to this drawing).

KEMET's F-Tech eliminates hidden defects in the dielectric which continue to grow in the field, causing capacitor failures. Based on the fundamental understanding of degradation mechanisms in tantalum and niobium capacitors, F-Tech incorporates multiple process methodologies. Some minimize the oxygen and carbon content in the anodes which become contaminants and can lead to the crystallization of the anodic oxide dielectric. This process methodology reduces the contaminants, improving quality of the dielectric. An additional technology provides a stronger mechanical connection point between the tantalum lead wire and tantalum anode, enhancing robustness and product reliability. The benefit of F-Tech is illustrated by a 2,000 hour, 85°C, 1.32 X rated voltage accelerated life test. F-Tech parts see no degradation while standard tantalum's have 1.5 orders of magnitude degradation in leakage current. F-Tech is currently available for the T493 Series (select D and X case capacitance values in 25 V and higher rated voltage). Please contact KEMET for details on ordering other part types with these capabilities.

KEMET's patented Simulated Breakdown Screening (SBDS) is a nondestructive testing technique that simulates the breakdown voltage (BDV) of a capacitor without damage to its dielectric or to the general population of capacitors. This screening identifies hidden defects in the dielectric, providing the highest level of dielectric testing. SBDS is based on the simulation of breakdown voltage (BDV), the ultimate test of the dielectric in a capacitor.

Low BDV indicates defects in the dielectric, and therefore, a higher probability of failure in the field. High BDV indicates a stronger dielectric and high-reliability performance in the field. This new screening method allows KEMET to identify the breakdown voltage of each individual capacitor and provide only the strongest capacitors from each lot.

SBDS is currently available on select part types in the T493 and T497 Series. Please contact KEMET for details on ordering other part types with these capabilities.

KEMET offers these technologies per the following options:

- F-Tech only
- SBDS only
- Combination of both F-Tech and SBDS for the ultimate protection

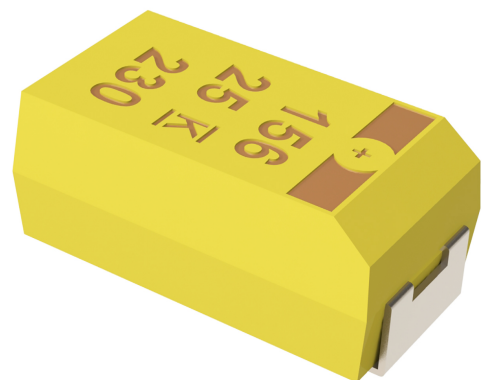

Benefits

- F-Tech and Simulated Breakdown Voltage (SBDS) screening options available
- Taped and reeled per EIA 481
- Symmetrical, compliant terminations
- Laser-marked case
- 100% surge current test available on all case sizes
- Termination options B, C, H, K, T, N, and M
- Weibull failure options B and C
- Voltage rating of 4 – 63 VDC
- Operating temperature range of -55°C to +125°C
- Capacitance values of 0.1 µF to 470 µF
- All parts tested per Group A of MIL-PRF-55365
- Approved for DLA Drawing 07016 applications*
 * Defense Logistics Agency (DLA), previously identified as DSCC

Applications

Typical applications include decoupling and filtering in military and aerospace applications.

Environmental Compliance

RoHS Compliant (6/6) according to Directive 2002/95/EC when ordered with 100% Sn solder.

K-SIM

For a detailed analysis of specific part numbers, please visit ksim.kemet.com to access KEMET's K-SIM software. KEMET K-SIM is designed to simulate behavior of components with respect to frequency, ambient temperature, and DC bias levels.

Ordering Information

| T | 493 | D | 227 | K | 006 | C | H | 61 | 20 | |
|-----------------|---------------|------------------|--|---------------------------------|--|--|--|--|---|--|
| Capacitor Class | Series | Case Size | Capacitance Code (pF) | Capacitance Tolerance | Rated Voltage (VDC) | Failure Rate/Design | Termination Finish | Surge | ESR | Packaging (C-Spec) |
| T = Tantalum | Military COTS | A, B, C, D, E, X | First two digits represent significant figures. Third digit specifies number of zeros. | J = ±5% K = ±10% M = ±20% | 004 = 4 006 = 6.3 010 = 10 016 = 16 020 = 20 025 = 25 035 = 35 050 = 50 063 = 63 | A = N/A B = 0.1% /1,000 hours C = 0.01% /1,000 hours | C = Hot solder dipped H = Standard solder coated (SnPb 5% Pb minimum) B = Gold plated K = Solder fused T = 100% Tin N = Non-magnetic 100% Tin (Sn) M = Non-magnetic (SnPb) | 61 = None 62 = 10 Cycles after Weibull, 25°C 63 = 10 cycles after Weibull, -55°C and 85°C after Weibull 64 = 10 cycles before Weibull, -55° and +85°C | 10 = ESR – Standard 20 = ESR – Low 30 = ESR – Ultra low | Blank = 7" Reel 7280 = 13" Reel 7610 = Bulk Bag 7640 = Bluk plastic box WAFL = Waffle Pack |

For detailed part number offerings, please refer to: Table 1A – COTS, Table 1B – DLA Drawing 07016

Ordering Information – DLA Drawing 07016

| 07016- | 001 | K | B | H | A |
|----------------|-----------------------|---------------------------------|---|---|--|
| Drawing Number | Dash Number | Capacitance Tolerance | Reliability Grade | Termination Finish | Surge |
| | See Part Number Table | J = ±5% K = ±10% M = ±20% | B = 0.1%/1,000 hours C = 0.01%/1,000 hours | C = Hot solder dipped H = Standard solder coated (SnPb 5% Pb minimum) B = Gold plated | A = + 25°C after Weibull B = -55°C and +85°C after Weibull C = -55°C and + 85°C before Weibull Z or no option= No test required |

For detailed part number offerings, please refer to: Table 1A – COTS, Table 1B – DLA Drawing 07016

Ordering Information – F-Tech & Simulated Breakdown Screening (SBDS)

| T | 493 | D | 226 | K | 020 | C | H | 61 | 20 | |
|-----------------|---------------|------------------|--|---------------------------------|--|--|--|--|--|--|
| Capacitor Class | Series | Case Size | Capacitance Code (pF) | Capacitance Tolerance | Rated Voltage (VDC) | Failure Rate/ Design | Termination Finish | Surge | Screening/ESR | Packaging (C-Spec) |
| T = Tantalum | Military COTS | A, B, C, D, E, X | First two digits represent significant figures. Third digit specifies number of zeros. | J = ±5% K = ±10% M = ±20% | 025 = 25 035 = 35 050 = 50 063 = 63 | A = N/A B = 0.1% /1,000 hours C = 0.01% /1,000 hours | C = Hot solder dipped H = Standard solder coated (SnPb 5% Pb minimum) B = Gold plated K = Solder fused T = 100% Tin N = Non-magnetic 100% Tin (Sn) M = Non-magnetic (SnPb) | 61 = None 62 = 10 Cycles after Weibull, 25°C 63 = 10 cycles after Weibull, -55°C and 85°C after Weibull 64 = 10 cycles before Weibull, -55° and +85°C | 11 = F-Tech + SBDS * 12 = SBDS 13 = F-Tech * 21 = Low ESR + 11 22= Low ESR + 12 23 = Low ESR + 13 31= Ultra Low ESR + 11 32 = Ultra Low ESR + 12 33 = Ultra Low ESR + 13 | Blank = 7" Reel 7280 = 13" Reel 7610 = Bulk Bag 7640 = Bluk plastic box WAFL = Waffle Pack |

* Select "C", "D" and "X" case sizes in 20 V and higher rated voltage

For detailed part number offerings, please refer to: Table 1A – COTS, Table 1B – DLA Drawing 07016

Performance Characteristics

| Item | Performance Characteristics |
|-------------------------|--|
| Operating Temperature | -55° C to 125° C |
| Rated Capacitance Range | 0.1 – 470 µF at 120 Hz/25°C |
| Capacitance Tolerance | J Tolerance (5%), K Tolerance (10%), M Tolerance (20%) |
| Rated Voltage Range | 4 – 63 V |
| DF (120 Hz) | Refer to Part Number Electrical Specification Table |
| ESR (100 kHz) | Refer to Part Number Electrical Specification Table |
| Leakage Current | ≤ 0.01 CV (µA) at rated voltage after 5 minutes |

Qualification

| Test | Condition | Characteristics | | | | |
|--------------------------------|--|-----------------|------------------------------|-------|----------|----------|
| Endurance | 85°C at rated voltage, 2,000 hours 125°C at 2/3 rated voltage, 2,000 hours | Δ C/C | Within ±10% of initial value | | | |
| | | DF | Within initial limits | | | |
| | | DCL | Within 1.25 x initial limit | | | |
| | | ESR | Within initial limits | | | |
| Storage Life | 125°C at 0 volts, 2,000 hours | Δ C/C | Within ±10% of initial value | | | |
| | | DF | Within initial limits | | | |
| | | DCL | Within 1.25 x initial limit | | | |
| | | ESR | Within initial limits | | | |
| Thermal Shock | MIL-STD-202, Method 107, Condition B, mounted, -55°C to 125°C, 1,000 cycles | Δ C/C | Within ±5% of initial value | | | |
| | | DF | Within initial limits | | | |
| | | DCL | Within 1.25 x initial limit | | | |
| | | ESR | Within initial limits | | | |
| Temperature Stability | Extreme temperature exposure at a succession of continuous steps at +25°C, -55°C, +25°C, +85°C, +125°C, +25°C | Δ C/C | +25°C | -55°C | +85°C | +125°C |
| | | DF | IL* | ±10% | ±10% | ±15% |
| | | DCL | IL | IL | 1.5 x IL | 1.5 x IL |
| Surge Voltage | 25°C and 85°C, 1.32 x rated voltage 1,000 cycles (125°C, 1.2 x rated voltage) | Δ C/C | Within ±5% of initial value | | | |
| | | DF | Within initial limits | | | |
| | | DCL | Within initial limits | | | |
| | | ESR | Within initial limits | | | |
| Mechanical Shock/ Vibration | MIL-STD-202, Method 213, Condition I, 100 G peak MIL-STD-202, Method 204, Condition D, 10 Hz to 2,000 Hz, 20 G peak | Δ C/C | Within ±10% of initial value | | | |
| | | DF | Within initial limits | | | |
| | | DCL | Within initial limits | | | |

*IL = Initial limit

Certification

MIL-PRF-55365/8
DLA Drawing 07016

Electrical Characteristics

ESR vs. Frequency

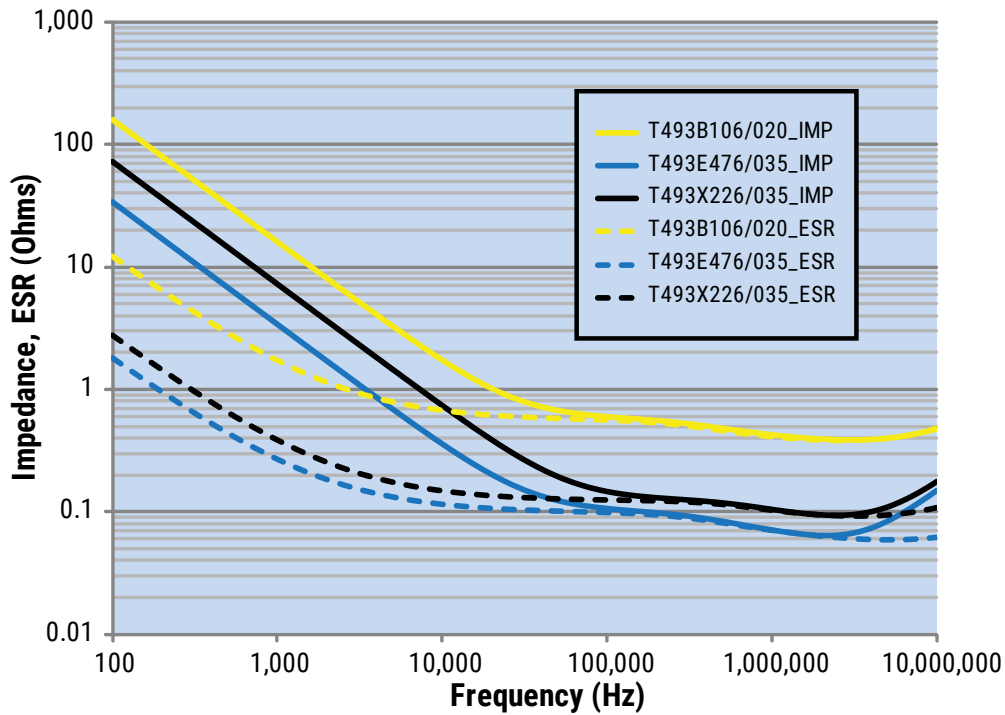

Capacitance vs. Frequency

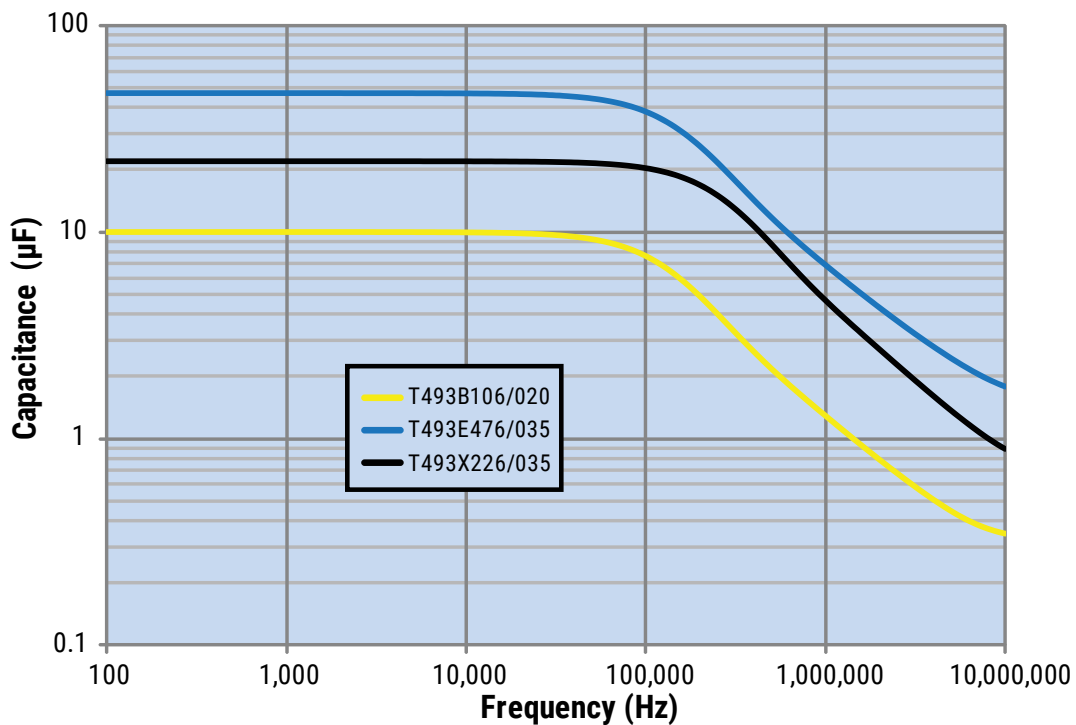

Dimensions – Millimeters (Inches)

Metric will govern

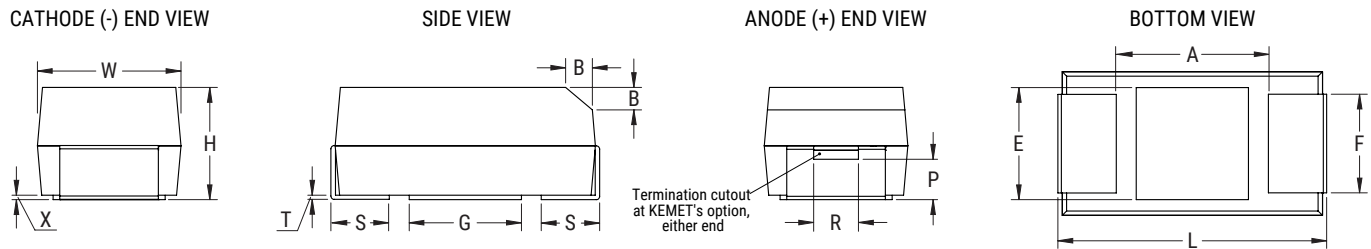

| Case Size | | Component | | | | | | | | | | | | Typical Weight | |
|-----------|---------|--------------------------|--------------------------|--------------------------|-------------------|-------------------|------------------------|----------------------------|----------------|----------------|-----------------|----------------|----------------|----------------|--------|
| KEMET | EIA | L | W | H | F ±0.1 ±(.004) | S ±0.3 ±(.012) | B ±0.15 (Ref) ±.006 | X (Ref) | P (Ref) | R (Ref) | T (Ref) | A (Min) | G (Ref) | E (Ref) | (mg) |
| A | 3216-18 | 3.2±0.2 (0.126±0.008) | 1.6±0.2 (0.063±0.008) | 1.6±0.2 (0.063±0.008) | 1.2 (0.047) | 0.8 (0.031) | 0.4 (0.016) | 0.10±0.10 (0.004±0.004) | 0.4 (0.016) | 0.4 (0.016) | 0.13 (0.005) | 1.2 (0.047) | 1.1 (0.043) | 1.3 (0.051) | 58.97 |
| B | 3528-21 | 3.5±0.2 (0.138±0.008) | 2.8±0.2 (0.110±0.008) | 1.9±0.2 (0.075±0.008) | 2.2 (0.087) | 0.8 (0.031) | 0.4 (0.016) | 0.10±0.10 (0.004±0.004) | 0.5 (0.020) | 1.0 (0.039) | 0.13 (0.005) | 1.9 (0.075) | 1.8 (0.071) | 2.2 (0.087) | 102.3 |
| C | 6032-28 | 6.0±0.3 (0.236±0.012) | 3.2±0.3 (0.126±0.012) | 2.5±0.3 (0.098±0.012) | 2.2 (0.087) | 1.3 (0.051) | 0.5 (0.020) | 0.10±0.10 (0.004±0.004) | 0.9 (0.035) | 1.0 (0.039) | 0.13 (0.005) | 3.1 (0.122) | 2.8 (0.110) | 2.4 (0.094) | 224.2 |
| D | 7343-31 | 7.3±0.3 (0.287±0.012) | 4.3±0.3 (0.169±0.012) | 2.8±0.3 (0.110±0.012) | 2.4 (0.094) | 1.3 (0.051) | 0.5 (0.020) | 0.10±0.10 (0.004±0.004) | 0.9 (0.035) | 1.0 (0.039) | 0.13 (0.005) | 3.8 (0.150) | 3.5 (0.138) | 3.5 (0.138) | 412.33 |
| X | 7343-43 | 7.3±0.3 (0.287±0.012) | 4.3±0.3 (0.169±0.012) | 4.0±0.3 (0.157±0.012) | 2.4 (0.094) | 1.3 (0.051) | 0.5 (0.020) | 0.10±0.10 (0.004±0.004) | 1.7 (0.067) | 1.0 (0.039) | 0.13 (0.005) | 3.8 (0.150) | 3.5 (0.138) | 3.5 (0.138) | 652.04 |
| E | 7360-38 | 7.3±0.3 (0.287±0.012) | 6.0±0.3 (0.236±0.012) | 3.6±0.2 (0.142±0.008) | 3.1 (0.120) | 1.3 (0.051) | 0.5 (0.020) | 0.10±0.10 (0.004±0.004) | N/A | N/A | 0.13 (0.005) | 3.8 (0.150) | 3.5 (0.138) | 3.5 (0.138) | 803.76 |

Notes: (Ref) – Dimensions provided for reference only. For low profile cases, no dimensions are provided for B, P or R because these cases do not have a bevel or a notch.

These weights are provided as reference. If exact weights are needed, please contact your KEMET Sales Representative

Dimensions – Millimeters (Inches) DLA Drawing 07016

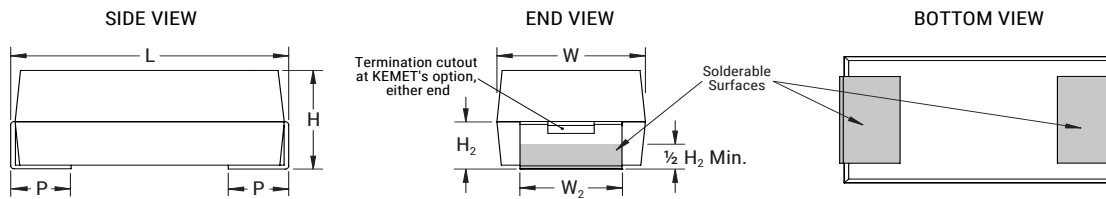

| Case Size | Component | | | | | Typical Weight |
|-----------|--------------------------|--------------------------|----------------|--------------------------|-----------------------------|----------------|
| KEMET | H | L | P ±0.3 (0.012) | W | W ₂ ±0.1 (0.004) | (mg) |
| A | 1.6±0.2 (0.063±0.008) | 3.2±0.2 (0.126±0.008) | 0.8 (0.031) | 1.6±0.2 (0.063±0.008) | 1.2 (0.047) | 58.97 |
| B | 1.9±0.2 (0.075±0.008) | 3.5±0.2 (0.138±0.008) | 0.8 (0.031) | 2.8±0.2 (0.110±0.008) | 2.2 (0.087) | 102.3 |
| C | 2.5±0.3 (0.098±0.012) | 6.0±0.3 (0.236±0.012) | 1.3 (0.051) | 3.2±0.3 (0.126±0.012) | 2.2 (0.087) | 224.2 |
| D | 2.8±0.3 (0.110±0.012) | 7.3±0.3 (0.287±0.012) | 1.3 (0.051) | 4.3±0.3 (0.169±0.012) | 2.4 (0.094) | 412.33 |
| X | 4.0±0.3 (0.157±0.012) | 7.3±0.3 (0.287±0.012) | 1.3 (0.051) | 4.3±0.3 (0.169±0.012) | 2.4 (0.094) | 652.04 |
| E | 3.6±0.2 (0.142±0.008) | 7.3±0.3 (0.287±0.012) | 1.3 (0.051) | 6.0±0.3 (0.236±0.012) | 3.1 (0.120)* | 803.76 |

* Previously, KEMET'S "W₂" dimension was 4.10 (0.161) for the "E" case.

These weights are provided as reference. If exact weights are needed, please contact your KEMET Sales Representative

Table 1A – Ratings & Part Number Reference

| Rated Voltage | Rated Capacitance | Case Code/ Case Size | KEMET Part Number | DC Leakage | DF | Standard ESR | Low ESR | Ultra-low ESR | Maximum Operating Temp | MSL |
|---------------|-------------------|-------------------------|------------------------------|-----------------------------------|---------------------------|---------------------------|---------------------------|---------------------------|------------------------|---------------------|
| VDC at 85°C | µF | KEMET/EIA | (See below for part options) | µA at +25°C Maximum/ 5 Minutes | % at +25°C 120 Hz Maximum | Ω at 25°C 100 kHz Maximum | Ω at 25°C 100 kHz Maximum | Ω at 25°C 100 kHz Maximum | °C | Reflow Temp ≤ 260°C |
| 4 | 2.2 | A/3216-18 | T493A225(1)004(2)(3)(4)(5) | 0.5 | 6.0 | 8.0 | 6.0 | N/A | 125 | 1 |
| 4 | 3.3 | A/3216-18 | T493A335(1)004(2)(3)(4)(5) | 0.5 | 6.0 | 8.0 | 4.0 | N/A | 125 | 1 |
| 4 | 4.7 | A/3216-18 | T493A475(1)004(2)(3)(4)(5) | 0.5 | 6.0 | 8.0 | 3.5 | N/A | 125 | 1 |
| 4 | 6.8 | A/3216-18 | T493A685(1)004(2)(3)(4)(5) | 0.5 | 6.0 | 6.0 | 3.0 | N/A | 125 | 1 |
| 4 | 6.8 | B/3528-21 | T493B685(1)004(2)(3)(4)(5) | 0.5 | 6.0 | 5.5 | 2.0 | N/A | 125 | 1 |
| 4 | 10 | A/3216-18 | T493A106(1)004(2)(3)(4)(5) | 0.5 | 6.0 | 6.0 | 2.0 | N/A | 125 | 1 |
| 4 | 10 | B/3528-21 | T493B106(1)004(2)(3)(4)(5) | 0.5 | 6.0 | 3.5 | 1.2 | N/A | 125 | 1 |
| 4 | 15 | A/3216-18 | T493A156(1)004(2)(3)(4)(5) | 0.6 | 6.0 | 4.0 | 1.5 | N/A | 125 | 1 |
| 4 | 15 | B/3528-21 | T493B156(1)004(2)(3)(4)(5) | 0.6 | 6.0 | 3.5 | 1.2 | N/A | 125 | 1 |
| 4 | 22 | A/3216-18 | T493A226(1)004(2)(3)(4)(5) | 0.9 | 6.0 | 4.0 | 1.5 | N/A | 125 | 1 |
| 4 | 22 | B/3528-21 | T493B226(1)004(2)(3)(4)(5) | 0.9 | 6.0 | 3.5 | 0.6 | N/A | 125 | 1 |
| 4 | 22 | C/6032-28 | T493C226(1)004(2)(3)(4)(5) | 0.9 | 6.0 | 1.8 | 0.5 | N/A | 125 | 1 |
| 4 | 33 | A/3216-18 | T493A336(1)004(2)(3)(4)(5) | 1.3 | 6.0 | 4.0 | 3.0 | N/A | 125 | 1 |
| 4 | 33 | B/3528-21 | T493B336(1)004(2)(3)(4)(5) | 1.3 | 6.0 | 3.5 | 0.5 | N/A | 125 | 1 |
| 4 | 33 | C/6032-28 | T493C336(1)004(2)(3)(4)(5) | 1.3 | 6.0 | 1.8 | 0.5 | N/A | 125 | 1 |
| 4 | 47 | B/3528-21 | T493B476(1)004(2)(3)(4)(5) | 1.9 | 6.0 | 3.0 | 0.5 | N/A | 125 | 1 |
| 4 | 47 | C/6032-28 | T493C476(1)004(2)(3)(4)(5) | 1.9 | 6.0 | 1.8 | 0.5 | N/A | 125 | 1 |
| 4 | 68 | B/3528-21 | T493B686(1)004(2)(3)(4)(5) | 2.7 | 6.0 | 3.5 | 2.0 | N/A | 125 | 1 |
| 4 | 68 | C/6032-28 | T493C686(1)004(2)(3)(4)(5) | 2.7 | 6.0 | 1.6 | 0.25 | N/A | 125 | 1 |
| 4 | 68 | D/7343-31 | T493D686(1)004(2)(3)(4)(5) | 2.7 | 6.0 | 0.8 | 0.2 | N/A | 125 | 1 |
| 4 | 100 | A/3216-18 | T493A107(1)004(2)(3)(4)(5) | 4 | 30.0 | 1.4 | N/A | N/A | 125 | 1 |
| 4 | 100 | B/3528-21 | T493B107(1)004(2)(3)(4)(5) | 4 | 8.0 | 1.0 | 0.7 | 0.50 | 125 | 1 |
| 4 | 100 | C/6032-28 | T493C107(1)004(2)(3)(4)(5) | 4 | 8.0 | 1.2 | 0.2 | N/A | 125 | 1 |
| 4 | 100 | D/7343-31 | T493D107(1)004(2)(3)(4)(5) | 4 | 8.0 | 0.8 | 0.2 | N/A | 125 | 1 |
| 4 | 150 | C/6032-28 | T493C157(1)004(2)(3)(4)(5) | 6 | 8.0 | 1.2 | 0.3 | 0.25 | 125 | 1 |
| 4 | 150 | D/7343-31 | T493D157(1)004(2)(3)(4)(5) | 6 | 8.0 | 0.8 | 0.15 | N/A | 125 | 1 |
| 4 | 220 | D/7343-31 | T493D227(1)004(2)(3)(4)(5) | 8.8 | 8.0 | 0.9 | 0.7 | N/A | 125 | 1 |
| 4 | 330 | D/7343-31 | T493D337(1)004(2)(3)(4)(5) | 13.2 | 8.0 | 0.7 | 0.15 | N/A | 125 | 1 |
| 4 | 330 | X/7343-43 | T493X337(1)004(2)(3)(4)(5) | 13.2 | 8.0 | 0.5 | 0.2 | N/A | 125 | 1 |
| 6.3 | 1.5 | A/3216-18 | T493A155(1)006(2)(3)(4)(5) | 0.5 | 6.0 | 8.0 | 6.0 | N/A | 125 | 1 |
| 6.3 | 2.2 | A/3216-18 | T493A225(1)006(2)(3)(4)(5) | 0.5 | 6.0 | 8.0 | 6.0 | N/A | 125 | 1 |
| 6.3 | 3.3 | A/3216-18 | T493A335(1)006(2)(3)(4)(5) | 0.5 | 6.0 | 8.0 | 6.0 | N/A | 125 | 1 |
| 6.3 | 4.7 | A/3216-18 | T493A475(1)006(2)(3)(4)(5) | 0.5 | 6.0 | 6.0 | 3.5 | N/A | 125 | 1 |
| 6.3 | 4.7 | B/3528-21 | T493B475(1)006(2)(3)(4)(5) | 0.5 | 6.0 | 5.5 | 3.5 | N/A | 125 | 1 |
| 6.3 | 6.8 | A/3216-18 | T493A685(1)006(2)(3)(4)(5) | 0.5 | 6.0 | 6.0 | 2.0 | N/A | 125 | 1 |
| 6.3 | 6.8 | B/3528-21 | T493B685(1)006(2)(3)(4)(5) | 0.5 | 6.0 | 3.5 | 1.2 | N/A | 125 | 1 |
| 6.3 | 10 | A/3216-18 | T493A106(1)006(2)(3)(4)(5) | 0.6 | 6.0 | 4.0 | 2.0 | N/A | 125 | 1 |
| 6.3 | 10 | B/3528-21 | T493B106(1)006(2)(3)(4)(5) | 0.6 | 6.0 | 3.5 | 1.0 | N/A | 125 | 1 |
| 6.3 | 15 | A/3216-18 | T493A156(1)006(2)(3)(4)(5) | 0.9 | 6.0 | 4.0 | 1.5 | N/A | 125 | 1 |
| 6.3 | 15 | B/3528-21 | T493B156(1)006(2)(3)(4)(5) | 0.9 | 6.0 | 3.5 | 0.7 | N/A | 125 | 1 |
| 6.3 | 15 | C/6032-28 | T493C156(1)006(2)(3)(4)(5) | 0.9 | 6.0 | 1.8 | 0.6 | N/A | 125 | 1 |
| 6.3 | 22 | A/3216-18 | T493A226(1)006(2)(3)(4)(5) | 1.4 | 6.0 | 4.0 | 3.0 | N/A | 125 | 1 |
| 6.3 | 22 | B/3528-21 | T493B226(1)006(2)(3)(4)(5) | 1.4 | 6.0 | 3.5 | 0.6 | N/A | 125 | 1 |
| 6.3 | 22 | C/6032-28 | T493C226(1)006(2)(3)(4)(5) | 1.4 | 6.0 | 1.8 | 0.5 | N/A | 125 | 1 |
| 6.3 | 33 | B/3528-21 | T493B336(1)006(2)(3)(4)(5) | 2.1 | 6.0 | 3.0 | 0.6 | N/A | 125 | 1 |
| 6.3 | 33 | C/6032-28 | T493C336(1)006(2)(3)(4)(5) | 2.1 | 6.0 | 1.8 | 0.3 | N/A | 125 | 1 |
| 6.3 | 47 | B/3528-21 | T493B476(1)006(2)(3)(4)(5) | 3.0 | 6.0 | 3.5 | 2.0 | N/A | 125 | 1 |
| VDC at 85°C | µF | KEMET/EIA | (See below for part options) | µA at +25°C Maximum/ 5 Minutes | % at +25°C 120 Hz Maximum | Ω at 25°C 100 kHz Maximum | Ω at 25°C 100 kHz Maximum | Ω at 25°C 100 kHz Maximum | °C | Reflow Temp ≤ 260°C |
| Rated Voltage | Rated Capacitance | Case Code/ Case Size | KEMET Part Number | DC Leakage | DF | Standard ESR | Low ESR | Ultra-low ESR | Maximum Operating Temp | MSL |

- (1) To complete KEMET part number, insert M for ± 20%, K for ± 10% or J for 5%. Designates Capacitance tolerance.
 - (2) To complete KEMET part number, insert B (0.1%/1,000 Hours), C (0.01%/1,000 Hours) or A = N/A. Designates Reliability Level.
 - (3) To complete KEMET part number, insert B = Gold Plated, C = Hot solder dipped, H = Solder Plated, K = Solder Fused or T = 100% Tin (Sn). Designates Termination Finish.
 - (4) To complete KEMET part number, insert 61 = None, 62 = 10 cycles +25°C, 63 = 10 cycles -55°C +85°C after Weibull 64 = 10 cycles -55°C +85°C before Weibull or 6(X)11, 6(X)12, 6(X)13, 6(X)21, 6(X)22, 6(X)23, 6(X)31, 6(X)32, 6(X)33. Designates screening options.
 - (5) To complete KEMET part number, insert 10 = Standard ESR, 20 = Low ESR or 30 = Ultra Low ESR. Designates ESR option.
- Refer to Ordering Information for additional detail.

Table 1A – Ratings & Part Number Reference cont'd

| Rated Voltage | Rated Capacitance | Case Code/ Case Size | KEMET Part Number | DC Leakage | DF | Standard ESR | Low ESR | Ultra-low ESR | Maximum Operating Temp | MSL |
|---------------|-------------------|-------------------------|------------------------------|-----------------------------------|---------------------------|---------------------------|---------------------------|---------------------------|------------------------|---------------------|
| VDC at 85°C | µF | KEMET/EIA | (See below for part options) | µA at +25°C Maximum/ 5 Minutes | % at +25°C 120 Hz Maximum | Ω at 25°C 100 kHz Maximum | Ω at 25°C 100 kHz Maximum | Ω at 25°C 100 kHz Maximum | °C | Reflow Temp ≤ 260°C |
| 6.3 | 47 | C/6032-28 | T493C476(1)006(2)(3)(4)(5) | 3.0 | 6.0 | 1.6 | 0.25 | N/A | 125 | 1 |
| 6.3 | 47 | D/7343-31 | T493D476(1)006(2)(3)(4)(5) | 3.0 | 6.0 | 0.8 | 0.22 | N/A | 125 | 1 |
| 6.3 | 68 | B/3528-21 | T493B686(1)006(2)(3)(4)(5) | 4.3 | 8.0 | 1.0 | 0.65 | N/A | 125 | 1 |
| 6.3 | 68 | C/6032-28 | T493C686(1)006(2)(3)(4)(5) | 4.3 | 6.0 | 1.2 | 0.2 | N/A | 125 | 1 |
| 6.3 | 68 | D/7343-31 | T493D686(1)006(2)(3)(4)(5) | 4.3 | 6.0 | 0.8 | 0.2 | 0.18 | 125 | 1 |
| 6.3 | 100 | B/3528-21 | T493B107(1)006(2)(3)(4)(5) | 6.3 | 15.0 | 10.0 | 8.0 | 0.70 | 125 | 1 |
| 6.3 | 100 | C/6032-28 | T493C107(1)006(2)(3)(4)(5) | 6.3 | 8.0 | 1.2 | 0.3 | 0.15 | 125 | 1 |
| 6.3 | 100 | D/7343-31 | T493D107(1)006(2)(3)(4)(5) | 6.3 | 8.0 | 0.8 | 0.15 | N/A | 125 | 1 |
| 6.3 | 150 | C/6032-28 | T493C157(1)006(2)(3)(4)(5) | 9.5 | 8.0 | 1.2 | 0.3 | 0.20 | 125 | 1 |
| 6.3 | 150 | D/7343-31 | T493D157(1)006(2)(3)(4)(5) | 9.5 | 8.0 | 0.7 | 0.15 | N/A | 125 | 1 |
| 6.3 | 220 | C/6032-28 | T493C227(1)006(2)(3)(4)(5) | 13.9 | 10.0 | 1.2 | 0.3 | 0.23 | 125 | 1 |
| 6.3 | 220 | D/7343-31 | T493D227(1)006(2)(3)(4)(5) | 13.9 | 8.0 | 0.7 | 0.1 | 0.10 | 125 | 1 |
| 6.3 | 220 | X/7343-43 | T493X227(1)006(2)(3)(4)(5) | 13.9 | 8.0 | 0.7 | 0.15 | 0.07 | 125 | 1 |
| 6.3 | 330 | D/7343-31 | T493D337(1)006(2)(3)(4)(5) | 20.8 | 8.0 | 0.5 | 0.15 | 0.10 | 125 | 1 |
| 6.3 | 330 | X/7343-43 | T493X337(1)006(2)(3)(4)(5) | 20.8 | 8.0 | 0.5 | 0.1 | 0.07 | 125 | 1 |
| 6.3 | 470 | X/7343-43 | T493X477(1)006(2)(3)(4)(5) | 29.6 | 10.0 | 0.2 | 0.1 | 0.05 | 125 | 1 |
| 10 | 1 | A/3216-18 | T493A105(1)010(2)(3)(4)(5) | 0.5 | 4.0 | 10.0 | 6.0 | N/A | 125 | 1 |
| 10 | 1.5 | A/3216-18 | T493A155(1)010(2)(3)(4)(5) | 0.5 | 6.0 | 8.0 | 6.0 | N/A | 125 | 1 |
| 10 | 2.2 | A/3216-18 | T493A225(1)010(2)(3)(4)(5) | 0.5 | 6.0 | 8.0 | 6.0 | N/A | 125 | 1 |
| 10 | 3.3 | A/3216-18 | T493A335(1)010(2)(3)(4)(5) | 0.5 | 6.0 | 6.0 | 4.0 | N/A | 125 | 1 |
| 10 | 3.3 | B/3528-21 | T493B335(1)010(2)(3)(4)(5) | 0.5 | 6.0 | 5.5 | 3.5 | N/A | 125 | 1 |
| 10 | 4.7 | A/3216-18 | T493A475(1)010(2)(3)(4)(5) | 0.5 | 6.0 | 6.0 | 3.0 | N/A | 125 | 1 |
| 10 | 4.7 | B/3528-21 | T493B475(1)010(2)(3)(4)(5) | 0.5 | 6.0 | 3.5 | 1.5 | 1.3 | 125 | 1 |
| 10 | 6.8 | A/3216-18 | T493A685(1)010(2)(3)(4)(5) | 0.7 | 6.0 | 6.0 | 3.0 | N/A | 125 | 1 |
| 10 | 6.8 | B/3528-21 | T493B685(1)010(2)(3)(4)(5) | 0.7 | 6.0 | 3.5 | 1.2 | 0.90 | 125 | 1 |
| 10 | 10 | A/3216-18 | T493A106(1)010(2)(3)(4)(5) | 1 | 6.0 | 4.0 | 1.8 | N/A | 125 | 1 |
| 10 | 10 | B/3528-21 | T493B106(1)010(2)(3)(4)(5) | 1 | 6.0 | 3.5 | 0.8 | 0.75 | 125 | 1 |
| 10 | 10 | C/6032-28 | T493C106(1)010(2)(3)(4)(5) | 1 | 6.0 | 1.8 | 0.6 | N/A | 125 | 1 |
| 10 | 15 | A/3216-18 | T493A156(1)010(2)(3)(4)(5) | 1.5 | 8.0 | 6.0 | 4.0 | 3.2 | 125 | 1 |
| 10 | 15 | B/3528-21 | T493B156(1)010(2)(3)(4)(5) | 1.5 | 6.0 | 3.5 | 0.7 | N/A | 125 | 1 |
| 10 | 15 | C/6032-28 | T493C156(1)010(2)(3)(4)(5) | 1.5 | 6.0 | 1.8 | 0.5 | 0.48 | 125 | 1 |
| 10 | 22 | B/3528-21 | T493B226(1)010(2)(3)(4)(5) | 2.2 | 6.0 | 3.0 | 0.7 | N/A | 125 | 1 |
| 10 | 22 | C/6032-28 | T493C226(1)010(2)(3)(4)(5) | 2.2 | 6.0 | 1.8 | 0.4 | 0.29 | 125 | 1 |
| 10 | 33 | B/3528-21 | T493B336(1)010(2)(3)(4)(5) | 3.3 | 6.0 | 3.5 | 2.0 | N/A | 125 | 1 |
| 10 | 33 | C/6032-28 | T493C336(1)010(2)(3)(4)(5) | 3.3 | 6.0 | 1.6 | 0.3 | N/A | 125 | 1 |
| 10 | 33 | D/7343-31 | T493D336(1)010(2)(3)(4)(5) | 3.3 | 6.0 | 0.8 | 0.3 | N/A | 125 | 1 |
| 10 | 47 | C/6032-28 | T493C476(1)010(2)(3)(4)(5) | 4.7 | 6.0 | 1.2 | 0.3 | N/A | 125 | 1 |
| 10 | 47 | D/7343-31 | T493D476(1)010(2)(3)(4)(5) | 4.7 | 6.0 | 0.8 | 0.2 | 0.08 | 125 | 1 |
| 10 | 68 | C/6032-28 | T493C686(1)010(2)(3)(4)(5) | 6.8 | 6.0 | 1.2 | 0.3 | 0.23 | 125 | 1 |
| 10 | 68 | D/7343-31 | T493D686(1)010(2)(3)(4)(5) | 6.8 | 6.0 | 0.8 | 0.2 | 0.09 | 125 | 1 |
| 10 | 68 | X/7343-43 | T493X686(1)010(2)(3)(4)(5) | 6.8 | 4.0 | 0.5 | 0.15 | N/A | 125 | 1 |
| 10 | 100 | C/6032-28 | T493C107(1)010(2)(3)(4)(5) | 10 | 8.0 | 1.2 | 0.3 | N/A | 125 | 1 |
| 10 | 100 | D/7343-31 | T493D107(1)010(2)(3)(4)(5) | 10 | 8.0 | 0.7 | 0.1 | 0.08 | 125 | 1 |
| 10 | 150 | D/7343-31 | T493D157(1)010(2)(3)(4)(5) | 15 | 8.0 | 0.7 | 0.1 | 0.08 | 125 | 1 |
| 10 | 150 | X/7343-43 | T493X157(1)010(2)(3)(4)(5) | 15 | 8.0 | 0.7 | 0.2 | 0.09 | 125 | 1 |
| 10 | 220 | D/7343-31 | T493D227(1)010(2)(3)(4)(5) | 22 | 8.0 | 0.5 | 0.2 | 0.08 | 125 | 1 |
| 10 | 220 | X/7343-43 | T493X227(1)010(2)(3)(4)(5) | 22 | 8.0 | 0.5 | 0.1 | 0.05 | 125 | 1 |
| VDC at 85°C | µF | KEMET/EIA | (See below for part options) | µA at +25°C Maximum/ 5 Minutes | % at +25°C 120 Hz Maximum | Ω at 25°C 100 kHz Maximum | Ω at 25°C 100 kHz Maximum | Ω at 25°C 100 kHz Maximum | °C | Reflow Temp ≤ 260°C |
| Rated Voltage | Rated Capacitance | Case Code/ Case Size | KEMET Part Number | DC Leakage | DF | Standard ESR | Low ESR | Ultra-low ESR | Maximum Operating Temp | MSL |

- (1) To complete KEMET part number, insert M for ± 20%, K for ± 10% or J for 5%. Designates Capacitance tolerance.
 - (2) To complete KEMET part number, insert B (0.1%/1,000 Hours), C (0.01%/1,000 Hours) or A = N/A. Designates Reliability Level.
 - (3) To complete KEMET part number, insert B = Gold Plated, C = Hot solder dipped, H = Solder Plated, K = Solder Fused or T = 100% Tin (Sn). Designates Termination Finish.
 - (4) To complete KEMET part number, insert 61 = None, 62 = 10 cycles +25°C, 63 = 10 cycles -55°C +85°C after Weibull 64 = 10 cycles -55°C +85°C before Weibull or 6(X)11, 6(X)12, 6(X)13, 6(X)21, 6(X)22, 6(X)23, 6(X)31, 6(X)32, 6(X)33. Designates screening options.
 - (5) To complete KEMET part number, insert 10 = Standard ESR, 20 = Low ESR or 30 = Ultra Low ESR. Designates ESR option.
- Refer to Ordering Information for additional detail.

Table 1A – Ratings & Part Number Reference cont'd

| Rated Voltage | Rated Capacitance | Case Code/ Case Size | KEMET Part Number | DC Leakage | DF | Standard ESR | Low ESR | Ultra-low ESR | Maximum Operating Temp | MSL |
|---------------|-------------------|-------------------------|------------------------------|-----------------------------------|---------------------------|---------------------------|---------------------------|---------------------------|------------------------|---------------------|
| VDC at 85°C | µF | KEMET/EIA | (See below for part options) | µA at +25°C Maximum/ 5 Minutes | % at +25°C 120 Hz Maximum | Ω at 25°C 100 kHz Maximum | Ω at 25°C 100 kHz Maximum | Ω at 25°C 100 kHz Maximum | °C | Reflow Temp ≤ 260°C |
| 10 | 330 | X/7343-43 | T493X337(1)010(2)(3)(4)(5) | 33 | 10.0 | 0.5 | 0.1 | 0.05 | 125 | 1 |
| 10 | 470 | X/7343-43 | T493X477(1)010(2)(3)(4)(5) | 47 | 10.0 | 0.2 | 0.05 | N/A | 125 | 1 |
| 16 | 0.68 | A/3216-18 | T493A684(1)016(2)(3)(4)(5) | 0.5 | 6.0 | 12.0 | 8.0 | N/A | 125 | 1 |
| 16 | 1 | A/3216-18 | T493A105(1)016(2)(3)(4)(5) | 0.5 | 4.0 | 10.0 | 6.0 | N/A | 125 | 1 |
| 16 | 1.5 | A/3216-18 | T493A155(1)016(2)(3)(4)(5) | 0.5 | 6.0 | 8.0 | 6.0 | N/A | 125 | 1 |
| 16 | 2.2 | A/3216-18 | T493A225(1)016(2)(3)(4)(5) | 0.5 | 6.0 | 6.0 | 4.0 | N/A | 125 | 1 |
| 16 | 3.3 | A/3216-18 | T493A335(1)016(2)(3)(4)(5) | 0.5 | 6.0 | 6.0 | 3.5 | N/A | 125 | 1 |
| 16 | 3.3 | B/3528-21 | T493B335(1)016(2)(3)(4)(5) | 0.5 | 6.0 | 3.5 | 2.0 | N/A | 125 | 1 |
| 16 | 4.7 | A/3216-18 | T493A475(1)016(2)(3)(4)(5) | 0.8 | 6.0 | 6.0 | 3.0 | N/A | 125 | 1 |
| 16 | 4.7 | B/3528-21 | T493B475(1)016(2)(3)(4)(5) | 0.8 | 6.0 | 3.5 | 1.5 | N/A | 125 | 1 |
| 16 | 6.8 | A/3216-18 | T493A685(1)016(2)(3)(4)(5) | 1.1 | 6.0 | 7.0 | 3.0 | N/A | 125 | 1 |
| 16 | 6.8 | B/3528-21 | T493B685(1)016(2)(3)(4)(5) | 1.1 | 6.0 | 3.5 | 1.2 | N/A | 125 | 1 |
| 16 | 6.8 | C/6032-28 | T493C685(1)016(2)(3)(4)(5) | 1.1 | 6.0 | 1.9 | 0.8 | 0.75 | 125 | 1 |
| 16 | 10 | A/3216-18 | T493A106(1)016(2)(3)(4)(5) | 1.6 | 6.0 | 3.0 | N/A | N/A | 125 | 1 |
| 16 | 10 | B/3528-21 | T493B106(1)016(2)(3)(4)(5) | 1.6 | 6.0 | 3.5 | 0.8 | N/A | 125 | 1 |
| 16 | 10 | C/6032-28 | T493C106(1)016(2)(3)(4)(5) | 1.6 | 6.0 | 1.8 | 0.6 | N/A | 125 | 1 |
| 16 | 15 | B/3528-21 | T493B156(1)016(2)(3)(4)(5) | 2.4 | 6.0 | 3.0 | 0.8 | N/A | 125 | 1 |
| 16 | 15 | C/6032-28 | T493C156(1)016(2)(3)(4)(5) | 2.4 | 6.0 | 1.8 | 0.4 | N/A | 125 | 1 |
| 16 | 22 | B/3528-21 | T493B226(1)016(2)(3)(4)(5) | 3.5 | 6.0 | 2.2 | 0.8 | N/A | 125 | 1 |
| 16 | 22 | C/6032-28 | T493C226(1)016(2)(3)(4)(5) | 3.5 | 6.0 | 1.6 | 0.4 | N/A | 125 | 1 |
| 16 | 22 | D/7343-31 | T493D226(1)016(2)(3)(4)(5) | 3.5 | 6.0 | 0.8 | 0.3 | N/A | 125 | 1 |
| 16 | 33 | C/6032-28 | T493C336(1)016(2)(3)(4)(5) | 5.3 | 6.0 | 1.2 | 0.3 | 0.23 | 125 | 1 |
| 16 | 33 | D/7343-31 | T493D336(1)016(2)(3)(4)(5) | 5.3 | 6.0 | 0.8 | 0.25 | 0.15 | 125 | 1 |
| 16 | 47 | C/6032-28 | T493C476(1)016(2)(3)(4)(5) | 7.5 | 6.0 | 1.2 | 0.5 | 0.35 | 125 | 1 |
| 16 | 47 | D/7343-31 | T493D476(1)016(2)(3)(4)(5) | 7.5 | 6.0 | 0.8 | 0.2 | 0.10 | 125 | 1 |
| 16 | 68 | D/7343-31 | T493D686(1)016(2)(3)(4)(5) | 10.9 | 6.0 | 0.7 | 0.2 | 0.15 | 125 | 1 |
| 16 | 100 | D/7343-31 | T493D107(1)016(2)(3)(4)(5) | 16 | 8.0 | 0.7 | 0.125 | 0.10 | 125 | 1 |
| 16 | 100 | X/7343-43 | T493X107(1)016(2)(3)(4)(5) | 16 | 8.0 | 0.7 | 0.1 | 0.08 | 125 | 1 |
| 16 | 150 | D/7343-31 | T493D157(1)016(2)(3)(4)(5) | 24 | 8.0 | 0.7 | 0.4 | 0.15 | 125 | 1 |
| 16 | 150 | X/7343-43 | T493X157(1)016(2)(3)(4)(5) | 24 | 8.0 | 0.5 | 0.2 | 0.10 | 125 | 1 |
| 16 | 220 | X/7343-43 | T493X227(1)016(2)(3)(4)(5) | 35.2 | 12.0 | 0.5 | 0.2 | 0.10 | 125 | 1 |
| 20 | 0.47 | A/3216-18 | T493A474(1)020(2)(3)(4)(5) | 0.5 | 4.0 | 14.0 | 9.0 | N/A | 125 | 1 |
| 20 | 0.68 | A/3216-18 | T493A684(1)020(2)(3)(4)(5) | 0.5 | 4.0 | 12.0 | 8.0 | N/A | 125 | 1 |
| 20 | 1 | A/3216-18 | T493A105(1)020(2)(3)(4)(5) | 0.5 | 4.0 | 10.0 | 5.5 | N/A | 125 | 1 |
| 20 | 1.5 | A/3216-18 | T493A155(1)020(2)(3)(4)(5) | 0.5 | 6.0 | 8.0 | 4.5 | N/A | 125 | 1 |
| 20 | 1.5 | B/3528-21 | T493B155(1)020(2)(3)(4)(5) | 0.5 | 6.0 | 6.0 | 4.0 | N/A | 125 | 1 |
| 20 | 2.2 | A/3216-18 | T493A225(1)020(2)(3)(4)(5) | 0.5 | 6.0 | 7.0 | 4.0 | N/A | 125 | 1 |
| 20 | 2.2 | B/3528-21 | T493B225(1)020(2)(3)(4)(5) | 0.5 | 6.0 | 3.5 | 1.5 | N/A | 125 | 1 |
| 20 | 3.3 | A/3216-18 | T493A335(1)020(2)(3)(4)(5) | 0.7 | 6.0 | 7.0 | 4.0 | N/A | 125 | 1 |
| 20 | 3.3 | B/3528-21 | T493B335(1)020(2)(3)(4)(5) | 0.7 | 6.0 | 3.5 | 1.3 | N/A | 125 | 1 |
| 20 | 4.7 | A/3216-18 | T493A475(1)020(2)(3)(4)(5) | 0.9 | 8.0 | 6.0 | 1.8 | N/A | 125 | 1 |
| 20 | 4.7 | B/3528-21 | T493B475(1)020(2)(3)(4)(5) | 0.9 | 6.0 | 3.5 | 1.0 | N/A | 125 | 1 |
| 20 | 4.7 | C/6032-28 | T493C475(1)020(2)(3)(4)(5) | 0.9 | 6.0 | 2.4 | 0.6 | N/A | 125 | 1 |
| 20 | 6.8 | B/3528-21 | T493B685(1)020(2)(3)(4)(5) | 1.4 | 6.0 | 3.5 | 1.0 | N/A | 125 | 1 |
| 20 | 6.8 | C/6032-28 | T493C685(1)020(2)(3)(4)(5) | 1.4 | 6.0 | 1.9 | 0.6 | N/A | 125 | 1 |
| 20 | 10 | B/3528-21 | T493B106(1)020(2)(3)(4)(5) | 2 | 6.0 | 3.0 | 1.0 | N/A | 125 | 1 |
| 20 | 10 | C/6032-28 | T493C106(1)020(2)(3)(4)(5) | 2 | 6.0 | 1.8 | 0.5 | 0.48 | 125 | 1 |
| VDC at 85°C | µF | KEMET/EIA | (See below for part options) | µA at +25°C Maximum/ 5 Minutes | % at +25°C 120 Hz Maximum | Ω at 25°C 100 kHz Maximum | Ω at 25°C 100 kHz Maximum | Ω at 25°C 100 kHz Maximum | °C | Reflow Temp ≤ 260°C |
| Rated Voltage | Rated Capacitance | Case Code/ Case Size | KEMET Part Number | DC Leakage | DF | Standard ESR | Low ESR | Ultra-low ESR | Maximum Operating Temp | MSL |

- (1) To complete KEMET part number, insert M for ± 20%, K for ± 10% or J for 5%. Designates Capacitance tolerance.
 - (2) To complete KEMET part number, insert B (0.1%/1,000 Hours), C (0.01%/1,000 Hours) or A = N/A. Designates Reliability Level.
 - (3) To complete KEMET part number, insert B = Gold Plated, C = Hot solder dipped, H = Solder Plated, K = Solder Fused or T = 100% Tin (Sn). Designates Termination Finish.
 - (4) To complete KEMET part number, insert 61 = None, 62 = 10 cycles +25°C, 63 = 10 cycles -55°C +85°C after Weibull 64 = 10 cycles -55°C +85°C before Weibull or 6(X)11, 6(X)12, 6(X)13, 6(X)21, 6(X)22, 6(X)23, 6(X)31, 6(X)32, 6(X)33. Designates screening options.
 - (5) To complete KEMET part number, insert 10 = Standard ESR, 20 = Low ESR or 30 = Ultra Low ESR. Designates ESR option.
- Refer to Ordering Information for additional detail.

Table 1A – Ratings & Part Number Reference cont'd

| Rated Voltage | Rated Capacitance | Case Code/ Case Size | KEMET Part Number | DC Leakage | DF | Standard ESR | Low ESR | Ultra-low ESR | Maximum Operating Temp | MSL |
|---------------|-------------------|-------------------------|------------------------------|-----------------------------------|---------------------------|---------------------------|---------------------------|---------------------------|------------------------|---------------------|
| VDC at 85°C | µF | KEMET/EIA | (See below for part options) | µA at +25°C Maximum/ 5 Minutes | % at +25°C 120 Hz Maximum | Ω at 25°C 100 kHz Maximum | Ω at 25°C 100 kHz Maximum | Ω at 25°C 100 kHz Maximum | °C | Reflow Temp ≤ 260°C |
| 20 | 15 | C/6032-28 | T493C156(1)020(2)(3)(4)(5) | 3 | 6.0 | 1.7 | 0.4 | 0.38 | 125 | 1 |
| 20 | 15 | D/7343-31 | T493D156(1)020(2)(3)(4)(5) | 3 | 6.0 | 1.0 | 0.35 | 0.28 | 125 | 1 |
| 20 | 22 | C/6032-28 | T493C226(1)020(2)(3)(4)(5) | 4.4 | 6.0 | 1.2 | 0.4 | N/A | 125 | 1 |
| 20 | 22 | D/7343-31 | T493D226(1)020(2)(3)(4)(5) | 4.4 | 6.0 | 0.8 | 0.3 | 0.18 | 125 | 1 |
| 20 | 33 | D/7343-31 | T493D336(1)020(2)(3)(4)(5) | 6.6 | 6.0 | 0.8 | 0.2 | 0.15 | 125 | 1 |
| 20 | 47 | D/7343-31 | T493D476(1)020(2)(3)(4)(5) | 9.4 | 6.0 | 0.7 | 0.2 | 0.10 | 125 | 1 |
| 20 | 47 | X/7343-43 | T493X476(1)020(2)(3)(4)(5) | 9.4 | 4.0 | 0.7 | 0.15 | 0.10 | 125 | 1 |
| 20 | 68 | D/7343-31 | T493D686(1)020(2)(3)(4)(5) | 13.6 | 8.0 | 0.7 | 0.2 | 0.15 | 125 | 1 |
| 20 | 68 | X/7343-43 | T493X686(1)020(2)(3)(4)(5) | 13.6 | 6.0 | 0.7 | 0.15 | 0.12 | 125 | 1 |
| 25 | 0.33 | A/3216-18 | T493A334(1)025(2)(3)(4)(5) | 0.5 | 4.0 | 15.0 | 10.0 | N/A | 125 | 1 |
| 25 | 0.47 | A/3216-18 | T493A474(1)025(2)(3)(4)(5) | 0.5 | 4.0 | 14.0 | 9.0 | N/A | 125 | 1 |
| 25 | 0.68 | A/3216-18 | T493A684(1)025(2)(3)(4)(5) | 0.5 | 4.0 | 10.0 | 6.0 | N/A | 125 | 1 |
| 25 | 0.68 | B/3528-21 | T493B684(1)025(2)(3)(4)(5) | 0.5 | 4.0 | 7.5 | 5.5 | N/A | 125 | 1 |
| 25 | 1 | A/3216-18 | T493A105(1)025(2)(3)(4)(5) | 0.5 | 4.0 | 8.0 | 4.0 | N/A | 125 | 1 |
| 25 | 1 | B/3528-21 | T493B105(1)025(2)(3)(4)(5) | 0.5 | 4.0 | 5.0 | 2.0 | N/A | 125 | 1 |
| 25 | 1.5 | A/3216-18 | T493A155(1)025(2)(3)(4)(5) | 0.5 | 6.0 | 10.0 | 3.0 | N/A | 125 | 1 |
| 25 | 1.5 | B/3528-21 | T493B155(1)025(2)(3)(4)(5) | 0.5 | 6.0 | 5.0 | 1.5 | N/A | 125 | 1 |
| 25 | 2.2 | A/3216-18 | T493A225(1)025(2)(3)(4)(5) | 0.6 | 6.0 | 7.0 | N/A | N/A | 125 | 1 |
| 25 | 2.2 | B/3528-21 | T493B225(1)025(2)(3)(4)(5) | 0.6 | 6.0 | 4.5 | 1.2 | N/A | 125 | 1 |
| 25 | 2.2 | C/6032-28 | T493C225(1)025(2)(3)(4)(5) | 0.6 | 6.0 | 3.5 | 2.2 | 1.30 | 125 | 1 |
| 25 | 3.3 | B/3528-21 | T493B335(1)025(2)(3)(4)(5) | 0.8 | 6.0 | 3.5 | 2.0 | N/A | 125 | 1 |
| 25 | 3.3 | C/6032-28 | T493C335(1)025(2)(3)(4)(5) | 0.8 | 6.0 | 2.5 | 1.2 | 0.75 | 125 | 1 |
| 25 | 4.7 | A/3216-18 | T493A475(1)025(2)(3)(4)(5) | 1.2 | 6.0 | 3.1 | N/A | N/A | 125 | 1 |
| 25 | 4.7 | B/3528-21 | T493B475(1)025(2)(3)(4)(5) | 1.2 | 6.0 | 1.5 | 1.0 | N/A | 125 | 1 |
| 25 | 4.7 | C/6032-28 | T493C475(1)025(2)(3)(4)(5) | 1.2 | 6.0 | 2.4 | 0.6 | 0.58 | 125 | 1 |
| 25 | 6.8 | B/3528-21 | T493B685(1)025(2)(3)(4)(5) | 1.7 | 6.0 | 2.8 | 0.7 | N/A | 125 | 1 |
| 25 | 6.8 | C/6032-28 | T493C685(1)025(2)(3)(4)(5) | 1.7 | 6.0 | 1.9 | 0.6 | 0.49 | 125 | 1 |
| 25 | 6.8 | D/7343-31 | T493D685(1)025(2)(3)(4)(5) | 1.7 | 6.0 | 1.4 | 1.0 | N/A | 125 | 1 |
| 25 | 10 | C/6032-28 | T493C106(1)025(2)(3)(4)(5) | 2.5 | 6.0 | 1.5 | 0.5 | 0.45 | 125 | 1 |
| 25 | 10 | D/7343-31 | T493D106(1)025(2)(3)(4)(5) | 2.5 | 6.0 | 1.0 | 0.4 | N/A | 125 | 1 |
| 25 | 15 | C/6032-28 | T493C156(1)025(2)(3)(4)(5) | 3.8 | 6.0 | 1.5 | 0.9 | N/A | 125 | 1 |
| 25 | 15 | D/7343-31 | T493D156(1)025(2)(3)(4)(5) | 3.8 | 6.0 | 1.0 | 0.35 | 0.28 | 125 | 1 |
| 25 | 15 | X/7343-43 | T493X156(1)025(2)(3)(4)(5) | 3.8 | 6.0 | 0.7 | 0.2 | N/A | 125 | 1 |
| 25 | 22 | C/6032-28 | T493C226(1)025(2)(3)(4)(5) | 5.5 | 6.0 | 0.4 | .275 | N/A | 125 | 1 |
| 25 | 22 | D/7343-31 | T493D226(1)025(2)(3)(4)(5) | 5.5 | 6.0 | 0.8 | 0.2 | N/A | 125 | 1 |
| 25 | 22 | X/7343-43 | T493X226(1)025(2)(3)(4)(5) | 5.5 | 4.0 | 0.7 | 0.23 | N/A | 125 | 1 |
| 25 | 33 | D/7343-31 | T493D336(1)025(2)(3)(4)(5) | 8.3 | 6.0 | 0.7 | 0.4 | 0.09 | 125 | 1 |
| 25 | 33 | X/7343-43 | T493X336(1)025(2)(3)(4)(5) | 8.3 | 6.0 | 0.7 | 0.3 | 0.18 | 125 | 1 |
| 25 | 47 | D/7343-31 | T493D476(1)025(2)(3)(4)(5) | 11.8 | 10.0 | 0.7 | 0.2 | 0.12 | 125 | 1 |
| 25 | 47 | X/7343-43 | T493X476(1)025(2)(3)(4)(5) | 11.8 | 6.0 | 0.7 | 0.3 | 0.15 | 125 | 1 |
| 25 | 68 | X/7343-43 | T493X686(1)025(2)(3)(4)(5) | 17 | 8.0 | 0.3 | N/A | N/A | 125 | 1 |
| 25 | 68 | E/7360-38 | T493E686(1)025(2)(3)(4)(5) | 17 | 8.0 | 0.1 | N/A | N/A | 125 | 1 |
| 35 | 0.1 | A/3216-18 | T493A104(1)035(2)(3)(4)(5) | 0.5 | 4.0 | 20.0 | 10.0 | N/A | 125 | 1 |
| 35 | 0.15 | A/3216-18 | T493A154(1)035(2)(3)(4)(5) | 0.5 | 4.0 | 19.0 | 6.0 | N/A | 125 | 1 |
| 35 | 0.22 | A/3216-18 | T493A224(1)035(2)(3)(4)(5) | 0.5 | 4.0 | 18.0 | 6.0 | N/A | 125 | 1 |
| 35 | 0.33 | A/3216-18 | T493A334(1)035(2)(3)(4)(5) | 0.5 | 4.0 | 15.0 | 6.0 | N/A | 125 | 1 |
| 35 | 0.47 | A/3216-18 | T493A474(1)035(2)(3)(4)(5) | 0.5 | 4.0 | 14.0 | 4.0 | N/A | 125 | 1 |
| VDC at 85°C | µF | KEMET/EIA | (See below for part options) | µA at +25°C Maximum/ 5 Minutes | % at +25°C 120 Hz Maximum | Ω at 25°C 100 kHz Maximum | Ω at 25°C 100 kHz Maximum | Ω at 25°C 100 kHz Maximum | °C | Reflow Temp ≤ 260°C |
| Rated Voltage | Rated Capacitance | Case Code/ Case Size | KEMET Part Number | DC Leakage | DF | Standard ESR | Low ESR | Ultra-low ESR | Maximum Operating Temp | MSL |

- (1) To complete KEMET part number, insert M for ± 20%, K for ± 10% or J for 5%. Designates Capacitance tolerance.
 - (2) To complete KEMET part number, insert B (0.1%/1,000 Hours), C (0.01%/1,000 Hours) or A = N/A. Designates Reliability Level.
 - (3) To complete KEMET part number, insert B = Gold Plated, C = Hot solder dipped, H = Solder Plated, K = Solder Fused or T = 100% Tin (Sn). Designates Termination Finish.
 - (4) To complete KEMET part number, insert 61 = None, 62 = 10 cycles +25°C, 63 = 10 cycles -55°C +85°C after Weibull 64 = 10 cycles -55°C +85°C before Weibull or 6(X)11, 6(X)12, 6(X)13, 6(X)21, 6(X)22, 6(X)23, 6(X)31, 6(X)32, 6(X)33. Designates screening options.
 - (5) To complete KEMET part number, insert 10 = Standard ESR, 20 = Low ESR or 30 = Ultra Low ESR. Designates ESR option.
- Refer to Ordering Information for additional detail.

Table 1A – Ratings & Part Number Reference cont'd

| Rated Voltage | Rated Capacitance | Case Code/ Case Size | KEMET Part Number | DC Leakage | DF | Standard ESR | Low ESR | Ultra-low ESR | Maximum Operating Temp | MSL |
|---------------|-------------------|-------------------------|------------------------------|--------------------------------|---------------------------|---------------------------|---------------------------|---------------------------|------------------------|---------------------|
| VDC at 85°C | µF | KEMET/EIA | (See below for part options) | µA at +25°C Maximum/ 5 Minutes | % at +25°C 120 Hz Maximum | Ω at 25°C 100 kHz Maximum | Ω at 25°C 100 kHz Maximum | Ω at 25°C 100 kHz Maximum | °C | Reflow Temp ≤ 260°C |
| 35 | 0.47 | B/3528-21 | T493B474(1)035(2)(3)(4)(5) | 0.5 | 4.0 | 8.0 | 2.5 | 1.5 | 125 | 1 |
| 35 | 0.68 | A/3216-18 | T493A684(1)035(2)(3)(4)(5) | 0.5 | 4.0 | 10.0 | 6.0 | N/A | 125 | 1 |
| 35 | 0.68 | B/3528-21 | T493B684(1)035(2)(3)(4)(5) | 0.5 | 4.0 | 6.5 | 2.5 | N/A | 125 | 1 |
| 35 | 1 | A/3216-18 | T493A105(1)035(2)(3)(4)(5) | 0.5 | 4.0 | 10.0 | 6.0 | N/A | 125 | 1 |
| 35 | 1 | B/3528-21 | T493B105(1)035(2)(3)(4)(5) | 0.5 | 4.0 | 5.0 | 2.0 | 1.5 | 125 | 1 |
| 35 | 1.5 | A/3216-18 | T493A155(1)035(2)(3)(4)(5) | 0.5 | 6.0 | 7.5 | N/A | N/A | 125 | 1 |
| 35 | 1.5 | B/3528-21 | T493B155(1)035(2)(3)(4)(5) | 0.5 | 6.0 | 5.0 | 3.0 | N/A | 125 | 1 |
| 35 | 1.5 | C/6032-28 | T493C155(1)035(2)(3)(4)(5) | 0.5 | 6.0 | 4.5 | 2.5 | N/A | 125 | 1 |
| 35 | 2.2 | B/3528-21 | T493B225(1)035(2)(3)(4)(5) | 0.8 | 6.0 | 4.0 | 2.5 | 1.5 | 125 | 1 |
| 35 | 2.2 | C/6032-28 | T493C225(1)035(2)(3)(4)(5) | 0.8 | 6.0 | 3.5 | 1.5 | 0.75 | 125 | 1 |
| 35 | 3.3 | B/3528-21 | T493B335(1)035(2)(3)(4)(5) | 1.2 | 6.0 | 3.5 | 1.3 | N/A | 125 | 1 |
| 35 | 3.3 | C/6032-28 | T493C335(1)035(2)(3)(4)(5) | 1.2 | 6.0 | 2.5 | 0.8 | 0.60 | 125 | 1 |
| 35 | 4.7 | B/3528-21 | T493B475(1)035(2)(3)(4)(5) | 1.6 | 6.0 | 1.5 | N/A | N/A | 125 | 1 |
| 35 | 4.7 | C/6032-28 | T493C475(1)035(2)(3)(4)(5) | 1.6 | 6.0 | 2.5 | 0.6 | 0.45 | 125 | 1 |
| 35 | 4.7 | D/7343-31 | T493D475(1)035(2)(3)(4)(5) | 1.6 | 6.0 | 1.5 | 0.7 | N/A | 125 | 1 |
| 35 | 6.8 | C/6032-28 | T493C685(1)035(2)(3)(4)(5) | 2.4 | 6.0 | 2.0 | 0.9 | N/A | 125 | 1 |
| 35 | 6.8 | D/7343-31 | T493D685(1)035(2)(3)(4)(5) | 2.4 | 6.0 | 1.3 | 0.5 | 0.40 | 125 | 1 |
| 35 | 10 | C/6032-28 | T493C106(1)035(2)(3)(4)(5) | 3.5 | 6.0 | 2.0 | 1.2 | N/A | 125 | 1 |
| 35 | 10 | D/7343-31 | T493D106(1)035(2)(3)(4)(5) | 3.5 | 6.0 | 1.0 | 0.3 | 0.25 | 125 | 1 |
| 35 | 10 | X/7343-43 | T493X106(1)035(2)(3)(4)(5) | 3.5 | 4.0 | 0.9 | 0.25 | 0.18 | 125 | 1 |
| 35 | 15 | C/6032-28 | T493C156(1)035(2)(3)(4)(5) | 5.3 | 6.0 | 0.45 | N/A | N/A | 125 | 1 |
| 35 | 15 | D/7343-31 | T493D156(1)035(2)(3)(4)(5) | 5.3 | 6.0 | 0.8 | 0.3 | 0.23 | 125 | 1 |
| 35 | 15 | X/7343-43 | T493X156(1)035(2)(3)(4)(5) | 5.3 | 6.0 | 0.9 | 0.3 | 0.20 | 125 | 1 |
| 35 | 22 | D/7343-31 | T493D226(1)035(2)(3)(4)(5) | 7.7 | 6.0 | 0.7 | 0.4 | 0.20 | 125 | 1 |
| 35 | 22 | X/7343-43 | T493X226(1)035(2)(3)(4)(5) | 7.7 | 6.0 | 0.7 | 0.3 | 0.20 | 125 | 1 |
| 35 | 33 | D/7343-31 | T493D336M035(2)(3)(4)(5) | 11.6 | 6.0 | 0.3 | N/A | N/A | 125 | 1 |
| 35 | 33 | X/7343-43 | T493X336(1)035(2)(3)(4)(5) | 11.6 | 6.0 | 0.6 | 0.3 | 0.18 | 125 | 1 |
| 35 | 47 | X/7343-43 | T493X476(1)035(2)(3)(4)(5) | 16.5 | 6.0 | 0.25 | N/A | N/A | 125 | 1 |
| 35 | 47 | E/7360-38 | T493E476(1)035(2)(3)(4)(5) | 16.5 | 10.0 | 0.5 | 0.3 | N/A | 125 | 1 |
| 50 | 0.1 | A/3216-18 | T493A104(1)050(2)(3)(4)(5) | 0.5 | 4.0 | 20.0 | 10.0 | N/A | 125 | 1 |
| 50 | 0.15 | A/3216-18 | T493A154(1)050(2)(3)(4)(5) | 0.5 | 4.0 | 19.0 | 10.0 | N/A | 125 | 1 |
| 50 | 0.15 | B/3528-21 | T493B154(1)050(2)(3)(4)(5) | 0.5 | 4.0 | 16.0 | 10.0 | N/A | 125 | 1 |
| 50 | 0.22 | A/3216-18 | T493A224(1)050(2)(3)(4)(5) | 0.5 | 4.0 | 18.0 | N/A | N/A | 125 | 1 |
| 50 | 0.22 | B/3528-21 | T493B224(1)050(2)(3)(4)(5) | 0.5 | 4.0 | 14.0 | 10.0 | N/A | 125 | 1 |
| 50 | 0.33 | B/3528-21 | T493B334(1)050(2)(3)(4)(5) | 0.5 | 4.0 | 10.0 | 2.5 | N/A | 125 | 1 |
| 50 | 0.47 | B/3528-21 | T493B474(1)050(2)(3)(4)(5) | 0.5 | 4.0 | 9.0 | 2.0 | N/A | 125 | 1 |
| 50 | 0.47 | C/6032-28 | T493C474(1)050(2)(3)(4)(5) | 0.5 | 4.0 | 8.0 | 1.8 | N/A | 125 | 1 |
| 50 | 0.68 | A/3216-18 | T493A684(1)050(2)(3)(4)(5) | 0.5 | 4.0 | 7.9 | N/A | N/A | 125 | 1 |
| 50 | 0.68 | C/6032-28 | T493C684(1)050(2)(3)(4)(5) | 0.5 | 4.0 | 7.0 | 1.6 | N/A | 125 | 1 |
| 50 | 1 | B/3528-21 | T493B105(1)050(2)(3)(4)(5) | 0.5 | 4.0 | 7.0 | N/A | N/A | 125 | 1 |
| 50 | 1 | C/6032-28 | T493C105(1)050(2)(3)(4)(5) | 0.5 | 4.0 | 5.5 | 1.6 | 1.3 | 125 | 1 |
| 50 | 1.5 | C/6032-28 | T493C155(1)050(2)(3)(4)(5) | 0.8 | 6.0 | 4.5 | 1.5 | N/A | 125 | 1 |
| 50 | 1.5 | D/7343-31 | T493D155(1)050(2)(3)(4)(5) | 0.8 | 6.0 | 3.5 | 1.0 | N/A | 125 | 1 |
| 50 | 2.2 | C/6032-28 | T493C225(1)050(2)(3)(4)(5) | 1.1 | 6.0 | 3.5 | 1.5 | N/A | 125 | 1 |
| 50 | 2.2 | D/7343-31 | T493D225(1)050(2)(3)(4)(5) | 1.1 | 6.0 | 2.5 | 0.8 | 0.60 | 125 | 1 |
| 50 | 3.3 | D/7343-31 | T493D335(1)050(2)(3)(4)(5) | 1.7 | 6.0 | 2.0 | 0.8 | 0.70 | 125 | 1 |
| 50 | 4.7 | D/7343-31 | T493D475(1)050(2)(3)(4)(5) | 2.4 | 6.0 | 1.5 | 0.6 | 0.28 | 125 | 1 |
| VDC at 85°C | µF | KEMET/EIA | (See below for part options) | µA at +25°C Maximum/ 5 Minutes | % at +25°C 120 Hz Maximum | Ω at 25°C 100 kHz Maximum | Ω at 25°C 100 kHz Maximum | Ω at 25°C 100 kHz Maximum | °C | Reflow Temp ≤ 260°C |
| Rated Voltage | Rated Capacitance | Case Code/ Case Size | KEMET Part Number | DC Leakage | DF | Standard ESR | Low ESR | Ultra-low ESR | Maximum Operating Temp | MSL |

- (1) To complete KEMET part number, insert M for ± 20%, K for ± 10% or J for 5%. Designates Capacitance tolerance.
 - (2) To complete KEMET part number, insert B (0.1%/1,000 Hours), C (0.01%/1,000 Hours) or A = N/A. Designates Reliability Level.
 - (3) To complete KEMET part number, insert B = Gold Plated, C = Hot solder dipped, H = Solder Plated, K = Solder Fused or T = 100% Tin (Sn). Designates Termination Finish.
 - (4) To complete KEMET part number, insert 61 = None, 62 = 10 cycles +25°C, 63 = 10 cycles -55°C +85°C after Weibull 64 = 10 cycles -55°C +85°C before Weibull or 6(X)11, 6(X)12, 6(X)13, 6(X)21, 6(X)22, 6(X)23, 6(X)31, 6(X)32, 6(X)33. Designates screening options.
 - (5) To complete KEMET part number, insert 10 = Standard ESR, 20 = Low ESR or 30 = Ultra Low ESR. Designates ESR option.
- Refer to Ordering Information for additional detail.

Table 1A – Ratings & Part Number Reference cont'd

| Rated Voltage | Rated Capacitance | Case Code/ Case Size | KEMET Part Number | DC Leakage | DF | Standard ESR | Low ESR | Ultra-low ESR | Maximum Operating Temp | MSL |
|---------------|-------------------|-------------------------|------------------------------|-----------------------------------|---------------------------|---------------------------|---------------------------|---------------------------|------------------------|---------------------|
| VDC at 85°C | µF | KEMET/EIA | (See below for part options) | µA at +25°C Maximum/ 5 Minutes | % at +25°C 120 Hz Maximum | Ω at 25°C 100 kHz Maximum | Ω at 25°C 100 kHz Maximum | Ω at 25°C 100 kHz Maximum | °C | Reflow Temp ≤ 260°C |
| 50 | 4.7 | X/7343-43 | T493X475(1)050(2)(3)(4)(5) | 2.4 | 4.0 | 0.9 | 0.3 | N/A | 125 | 1 |
| 50 | 6.8 | D/7343-31 | T493D685(1)050(2)(3)(4)(5) | 3.4 | 6.0 | 0.6 | 0.3 | N/A | 125 | 1 |
| 50 | 6.8 | X/7343-43 | T493X685(1)050(2)(3)(4)(5) | 3.4 | 6.0 | 1.0 | 0.5 | N/A | 125 | 1 |
| 50 | 10 | X/7343-43 | T493X106(1)050(2)(3)(4)(5) | 5 | 6.0 | 0.7 | 0.4 | N/A | 125 | 1 |
| 50 | 15 | X/7343-43 | T493X156(1)050(2)(3)(4)(5) | 7.5 | 6.0 | 1.0 | N/A | N/A | 125 | 1 |
| 63 | 6.8 | X/7343-43 | T493X685(1)063(2)(3)(4)(5) | 4.3 | 6.0 | 1.0 | 0.6 | 0.3 | 125 | 1 |
| 63 | 10 | X/7343-43 | T493X106(1)063(2)(3)(4)(5) | 6.3 | 6.0 | 0.6 | 0.4 | 0.2 | 125 | 1 |
| VDC at 85°C | µF | KEMET/EIA | (See below for part options) | µA at +25°C Maximum/ 5 Minutes | % at +25°C 120 Hz Maximum | Ω at 25°C 100 kHz Maximum | Ω at 25°C 100 kHz Maximum | Ω at 25°C 100 kHz Maximum | °C | Reflow Temp ≤ 260°C |
| Rated Voltage | Rated Capacitance | Case Code/ Case Size | KEMET Part Number | DC Leakage | DF | Standard ESR | Low ESR | Ultra-low ESR | Maximum Operating Temp | MSL |

- (1) To complete KEMET part number, insert M for ± 20%, K for ± 10% or J for 5%. Designates Capacitance tolerance.
(2) To complete KEMET part number, insert B (0.1%/1,000 Hours), C (0.01%/1,000 Hours) or A = N/A. Designates Reliability Level.
(3) To complete KEMET part number, insert B = Gold Plated, C = Hot solder dipped, H = Solder Plated, K = Solder Fused or T = 100% Tin (Sn). Designates Termination Finish.
(4) To complete KEMET part number, insert 61 = None, 62 = 10 cycles +25°C, 63 = 10 cycles -55°C +85°C after Weibull 64 = 10 cycles -55°C +85°C before Weibull or 6(X)11, 6(X)12, 6(X)13, 6(X)21, 6(X)22, 6(X)23, 6(X)31, 6(X)32, 6(X)33. Designates screening options.
(5) To complete KEMET part number, insert 10 = Standard ESR, 20 = Low ESR or 30 = Ultra Low ESR. Designates ESR option.
Refer to Ordering Information for additional detail.

Table 1B – DLA Drawing 07016, Ratings & Part Number Reference cont'd

| Rated Voltage | Rated Cap | Case Code/ Case Size | KEMET Part Number | DLA Drawing 07016 Part Number | DC Leakage | DF | Standard ESR | Maximum Operating Temp | MSL |
|----------------------|------------------|---------------------------------|---------------------------------------|---------------------------------------|------------------------------|------------------------------|------------------------------|-------------------------------|----------------------------|
| VDC at 85°C | µF | KEMET/EIA | (See page 2 for Ordering Information) | (See page 2 for Ordering Information) | µA at +25°C Max/5 Min | % at +25°C 120 Hz Max | Ω at+25°C 100 kHz Max | °C | Reflow Temp ≤ 260°C |
| 35 | 15 | C/6032-28 | T493C156(1)035(2)(3)(4)10 | 07016-146(1)(2)(3)(4) | 5.3 | 6.0 | 0.45 | 125 | 1 |
| 35 | 15 | D/7343-31 | T493D156(1)035(2)(3)(4)10 | 07016-147(1)(2)(3)(4) | 5.3 | 6.0 | 0.3 | 125 | 1 |
| 35 | 15 | D/7343-31 | T493D156(1)035(2)(3)(4)20 | 07016-148(1)(2)(3)(4) | 5.3 | 6.0 | 0.1 | 125 | 1 |
| 35 | 22 | D/7343-31 | T493D226(1)035(2)(3)(4)20 | 07016-149(1)(2)(3)(4) | 7.7 | 6.0 | 0.4 | 125 | 1 |
| 35 | 33 | D/7343-31 | T493D336M035(2)(3)(4)10 | 07016-152M(2)(3)(4) | 11.6 | 6.0 | 0.3 | 125 | 1 |
| 35 | 33 | D/7343-31 | T493D336M035(2)(3)(4)20 | 07016-153M(2)(3)(4) | 11.6 | 6.0 | 0.2 | 125 | 1 |
| 35 | 33 | X/7343-43 | T493X336(1)035(2)(3)(4)20 | 07016-154M(1)(2)(3)(4) | 11.6 | 6.0 | 0.3 | 125 | 1 |
| 35 | 47 | X/7343-43 | T493X476M035(2)(3)(4)10 | 07016-155M(1)(2)(3)(4) | 16.5 | 6.0 | 0.25 | 125 | 1 |
| 35 | 47 | E/7360-38 | T493E476M035(2)(3)(4)10 | 07016-156M(1)(2)(3)(4) | 16.5 | 6.0 | 0.20 | 125 | 1 |
| 50 | 0.15 | A/3216-18 | T493A154(1)050(2)(3)(4)20 | 07016-157M(1)(2)(3)(4) | 0.5 | 4.0 | 15.0 | 125 | 1 |
| 50 | 0.22 | A/3216-18 | T493A224M050(2)(3)(4)10 | 07016-158M(1)(2)(3)(4) | 0.5 | 4.0 | 18.0 | 125 | 1 |
| 50 | 0.47 | B/3528-20 | T493B474(1)050(2)(3)(4)20 | 07016-160(1)(2)(3)(4) | 0.5 | 4.0 | 9.5 | 125 | 1 |
| 50 | 0.68 | A/3216-18 | T493A684(1)050(2)(3)(4)10 | 07016-161(1)(2)(3)(4) | 0.5 | 4.0 | 7.9 | 125 | 1 |
| 50 | 1 | B/3528-20 | T493B105(1)050(2)(3)(4)10 | 07016-163(1)(2)(3)(4) | 0.5 | 4.0 | 7.0 | 125 | 1 |
| 50 | 1.5 | C/6032-28 | T493C155(1)050(2)(3)(4)20 | 07016-164(1)(2)(3)(4) | 0.8 | 6.0 | 2.0 | 125 | 1 |
| 50 | 1.5 | D/7343-31 | T493D155(1)050(2)(3)(4)20 | 07016-165(1)(2)(3)(4) | 0.8 | 6.0 | 1.5 | 125 | 1 |
| 50 | 2.2 | D/7343-31 | T493D225(1)050(2)(3)(4)20 | 07016-166(1)(2)(3)(4) | 1.1 | 6.0 | 1.2 | 125 | 1 |
| 50 | 3.3 | D/7343-31 | T493D335(1)050(2)(3)(4)20 | 07016-167(1)(2)(3)(4) | 1.7 | 6.0 | 0.8 | 125 | 1 |
| 50 | 4.7 | D/7343-31 | T493D475(1)050(2)(3)(4)30 | 07016-168(1)(2)(3)(4) | 2.4 | 6.0 | 0.3 | 125 | 1 |
| 50 | 6.8 | D/7343-31 | T493D685(1)050(2)(3)(4)10 | 07016-169(1)(2)(3)(4) | 3.4 | 6.0 | 0.6 | 125 | 1 |
| 50 | 6.8 | D/7343-31 | T493D685(1)050(2)(3)(4)20 | 07016-170(1)(2)(3)(4) | 3.4 | 6.0 | 0.3 | 125 | 1 |
| 50 | 6.8 | X/7343-43 | T493X685(1)050(2)(3)(4)20 | 07016-171(1)(2)(3)(4) | 3.4 | 6.0 | 0.4 | 125 | 1 |
| VDC at 85°C | µF | KEMET/EIA | (See page 2 for Ordering Information) | (See page 2 for Ordering Information) | µA at +25°C Max/5 Min | % at +25°C 120 Hz Max | Ω at+25°C 100 kHz Max | °C | Reflow Temp ≤ 260°C |
| Rated Voltage | Rated Cap | Case Code/ Case Size | KEMET Part Number | DLA Drawing 07016 Part Number | DC Leakage | DF | Standard ESR | Maximum Operating Temp | MSL |

Recommended Voltage Derating Guidelines

| | -55°C to 85°C | 85°C to 125°C |
|---|-----------------------|-----------------------|
| % Change in Working DC Voltage with Temperature | V _R | 67% of V _R |
| Recommended Maximum Application Voltage | 50% of V _R | 33% of V _R |

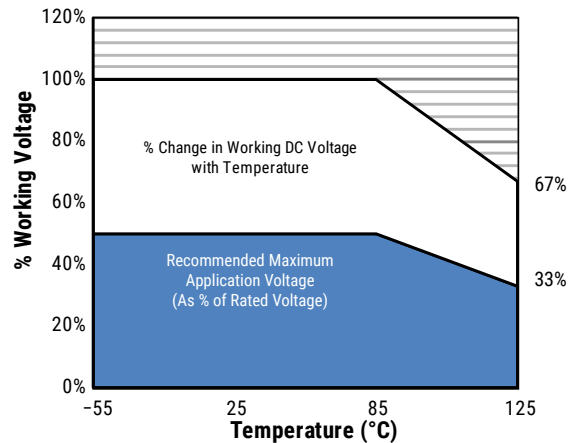

Ripple Current/Ripple Voltage

Permissible AC ripple voltage and current are related to equivalent series resistance (ESR) and the power dissipation capabilities of the device. Permissible AC ripple voltage which may be applied is limited by two criteria:

1. The positive peak AC voltage plus the DC bias voltage, if any, must not exceed the DC voltage rating of the capacitor.
2. The negative peak AC voltage in combination with bias voltage, if any, must not exceed the allowable limits specified for reverse voltage. See the Reverse Voltage section for allowable limits.

The maximum power dissipation by case size can be determined using the table at right. The maximum power dissipation rating stated in the table must be reduced with increasing environmental operating temperatures. Refer to the table below for temperature compensation requirements.

| KEMET Case Code | EIA Case Code | Maximum Power Dissipation (P max) mWatts at 25°C w/+20°C Rise |
|-----------------|---------------|---|
| A | 3216-18 | 75 |
| B | 3528-21 | 85 |
| C | 6032-28 | 110 |
| D | 7343-31 | 150 |
| X | 7343-43 | 165 |
| E | 7360-38 | 200 |
| S | 3216-12 | 60 |
| T | 3528-12 | 70 |
| U | 6032-15 | 90 |
| V | 7343-20 | 125 |
| T510X | 7343-43 | 270 |
| T510E | 7360-38 | 285 |

Using the P max of the device, the maximum allowable rms ripple current or voltage may be determined.

$$I(max) = \sqrt{P_{max}/R}$$

$$E(max) = Z \sqrt{P_{max}/R}$$

I = rms ripple current (amperes)
E = rms ripple voltage (volts)
P max = maximum power dissipation (watts)
R = ESR at specified frequency (ohms)
Z = Impedance at specified frequency (ohms)

| Temperature Compensation Multipliers for Maximum Ripple Current | | |
|---|----------|-----------|
| T ≤ 25°C | T ≤ 85°C | T ≤ 125°C |
| 1.00 | 0.90 | 0.40 |

T = Environmental Temperature

The maximum power dissipation rating must be reduced with increasing environmental operating temperatures. Refer to the Temperature Compensation Multiplier table for details.

Reverse Voltage

Solid tantalum capacitors are polar devices and may be permanently damaged or destroyed if connected with the wrong polarity. The positive terminal is identified on the capacitor body by a stripe plus in some cases a beveled edge. A small degree of transient reverse voltage is permissible for short periods per the table. The capacitors should not be operated continuously in reverse mode, even within these limits.

| Temperature | Permissible Transient Reverse Voltage |
|-------------|---------------------------------------|
| 25°C | 15% of Rated voltage |
| 85°C | 5% of Rated voltage |
| 125°C | 1% of Rated voltage |

Table 2 – Land Dimensions/Courtyard

| KEMET | Metric Size Code | Density Level A: Maximum (Most) Land Protrusion (mm) | | | | | Density Level B: Median (Nominal) Land Protrusion (mm) | | | | | Density Level C: Minimum (Least) Land Protrusion (mm) | | | | | | |
|-------|------------------|---|---------|------|------|------|---|------|------|------|------|--|------|------|------|------|------|------|
| | | Case | EIA | W | L | S | V1 | V2 | W | L | S | V1 | V2 | W | L | S | V1 | V2 |
| | | A | 3216-18 | 1.35 | 2.20 | 0.62 | 6.02 | 2.80 | 1.23 | 1.80 | 0.82 | 4.92 | 2.30 | 1.13 | 1.42 | 0.98 | 4.06 | 2.04 |
| | | B | 3528-21 | 2.35 | 2.21 | 0.92 | 6.32 | 4.00 | 2.23 | 1.80 | 1.12 | 5.22 | 3.50 | 2.13 | 1.42 | 1.28 | 4.36 | 3.24 |
| | | C | 6032-25 | 2.35 | 2.77 | 2.37 | 8.92 | 4.50 | 2.23 | 2.37 | 2.57 | 7.82 | 4.00 | 2.13 | 1.99 | 2.73 | 6.96 | 3.74 |
| | | D | 7343-31 | 2.55 | 2.77 | 3.67 | 10.22 | 5.60 | 2.43 | 2.37 | 3.87 | 9.12 | 5.10 | 2.33 | 1.99 | 4.03 | 8.26 | 4.84 |
| | | E ¹ | 7360-38 | 3.25 | 2.77 | 3.67 | 10.22 | 7.30 | 3.13 | 2.37 | 3.87 | 9.12 | 6.80 | 3.03 | 1.99 | 4.03 | 8.26 | 6.54 |
| | | X ¹ | 7343-43 | 2.55 | 2.77 | 3.67 | 10.22 | 5.60 | 2.43 | 2.37 | 3.87 | 9.12 | 5.10 | 2.33 | 1.99 | 4.03 | 8.26 | 4.84 |

Density Level A: For low-density product applications. Recommended for wave solder applications and provides a wider process window for reflow solder processes.

Density Level B: For products with a moderate level of component density. Provides a robust solder attachment condition for reflow solder processes.

Density Level C: For high component density product applications. Before adapting the minimum land pattern variations the user should perform qualification testing based on the conditions outlined in IPC standard 7351 (IPC-7351).

¹ Height of these chips may create problems in wave soldering.

² Land pattern geometry is too small for silkscreen outline.

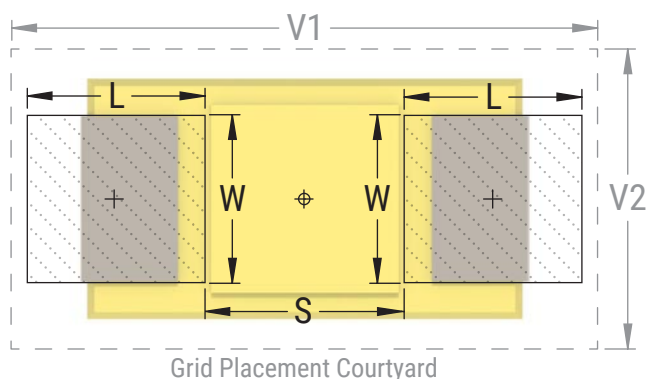

Soldering Process

KEMET’s families of surface mount capacitors are compatible with wave (single or dual), convection, IR, or vapor phase reflow techniques. Preheating of these components is recommended to avoid extreme thermal stress. KEMET’s recommended profile conditions for convection and IR reflow reflect the profile conditions of the IPC/J–STD–020D standard for moisture sensitivity testing. The devices can safely withstand a maximum of three reflow passes at these conditions.

Please note that although the X/7343–43 case size can withstand wave soldering, the tall profile (4.3 mm maximum) dictates care in wave process development.

Hand soldering should be performed with care due to the difficulty in process control. If performed, care should be taken to avoid contact of the soldering iron to the molded case. The iron should be used to heat the solder pad, applying solder between the pad and the termination, until reflow occurs. Once reflow occurs, the iron should be removed immediately. “Wiping” the edges of a chip and heating the top surface is not recommended.

During typical reflow operations, a slight darkening of the gold-colored epoxy may be observed. This slight darkening is normal and not harmful to the product. Marking permanency is not affected by this change.

| Profile Feature | SnPb Assembly | Pb-Free Assembly |
|---|---------------------|---------------------|
| Preheat/Soak | | |
| Temperature Minimum (T_{smin}) | 100°C | 150°C |
| Temperature Maximum (T_{smax}) | 150°C | 200°C |
| Time (t_s) from T_{smin} to T_{smax} | 60 – 120 seconds | 60 – 120 seconds |
| Ramp-up Rate (T_L to T_p) | 3°C/seconds maximum | 3°C/seconds maximum |
| Liquidous Temperature (T_L) | 183°C | 217°C |
| Time Above Liquidous (t_L) | 60 – 150 seconds | 60 – 150 seconds |
| Peak Temperature (T_p) | 220°C* 235°C** | 250°C* 260°C** |
| Time within 5°C of Maximum Peak Temperature (t_p) | 20 seconds maximum | 30 seconds maximum |
| Ramp-down Rate (T_p to T_L) | 6°C/seconds maximum | 6°C/seconds maximum |
| Time 25°C to Peak Temperature | 6 minutes maximum | 8 minutes maximum |

Note: All temperatures refer to the center of the package, measured on the package body surface that is facing up during assembly reflow.

*Case Size D, E, P, Y, and X

**Case Size A, B, C, H, I, K, M, R, S, T, U, V, W, and Z

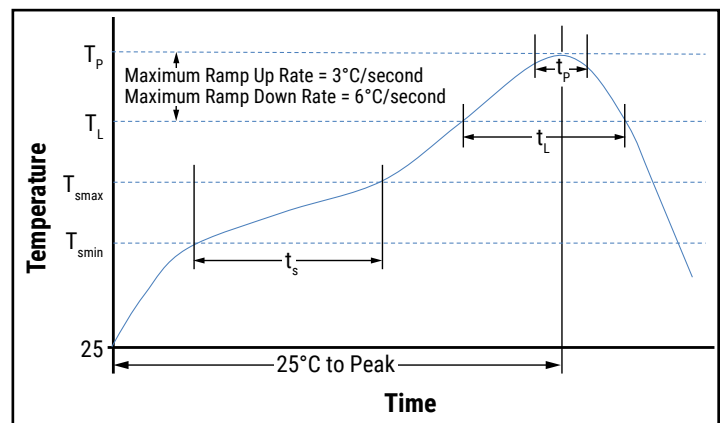

Storage

Tantalum chip capacitors should be stored in normal working environments. While the chips themselves are quite robust in other environments, solderability will be degraded by exposure to high temperatures, high humidity, corrosive atmospheres, and long term storage. In addition, packaging materials will be degraded by high temperature – reels may soften or warp and tape peel force may increase. KEMET recommends that maximum storage temperature not exceed 40°C and maximum storage humidity not exceed 60% relative humidity. Temperature fluctuations should be minimized to avoid condensation on the parts and atmospheres should be free of chlorine and sulphur bearing compounds. For optimized solderability chip stock should be used promptly, preferably within three years of receipt.

Construction

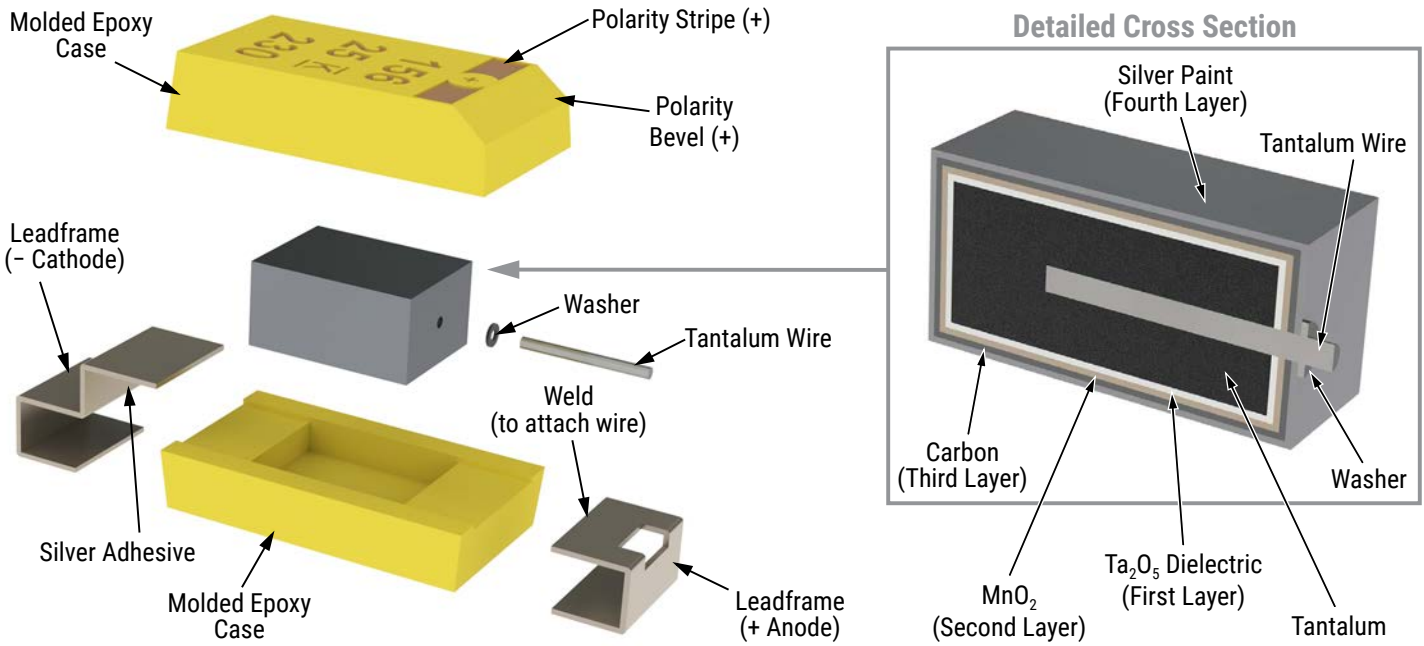

Capacitor Marking

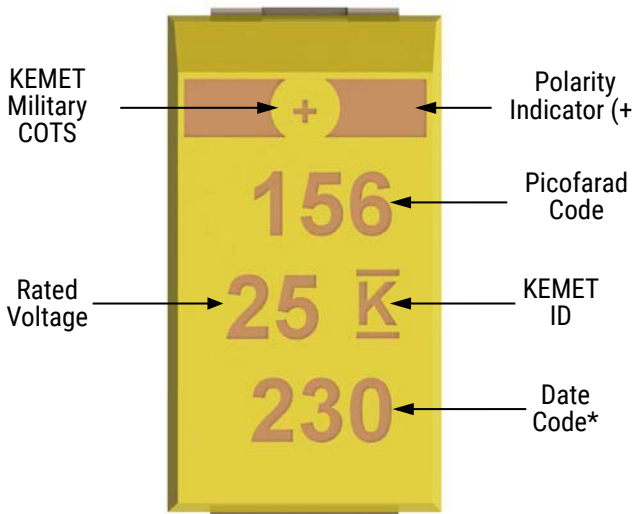

* 230 = 30th week of 2012

| Date Code * | |
|--|--|
| 1 st digit = Last number of Year | 2 = 2012 3 = 2013 4 = 2014 5 = 2015 6 = 2016 7 = 2017 |
| 2 nd and 3 rd digit = Week of the Year | 01 = 1 st week of the Year to 52 = 52 nd week of the Year |

Tape & Reel Packaging Information

KEMET’s molded chip capacitor families are packaged in 8 and 12 mm plastic tape on 7" and 13" reels in accordance with *EIA Standard 481: Embossed Carrier Taping of Surface Mount Components for Automatic Handling*. This packaging system is compatible with all tape-fed automatic pick-and-place systems.



Table 3 – Packaging Quantity

| Case Code | | Tape Width (mm) | 7" Reel* | 13" Reel* |
|-----------|---------|-----------------|----------|-----------|
| KEMET | EIA | | | |
| S | 3216-12 | 8 | 2,500 | 10,000 |
| T | 3528-12 | 8 | 2,500 | 10,000 |
| M | 3528-15 | 8 | 2,000 | 8,000 |
| U | 6032-15 | 12 | 1,000 | 5,000 |
| L | 6032-19 | 12 | 1,000 | 3,000 |
| W | 7343-15 | 12 | 1,000 | 3,000 |
| Z | 7343-17 | 12 | 1,000 | 3,000 |
| V | 7343-20 | 12 | 1,000 | 3,000 |
| A | 3216-18 | 8 | 2,000 | 9,000 |
| B | 3528-21 | 8 | 2,000 | 8,000 |
| C | 6032-28 | 12 | 500 | 3,000 |
| D | 7343-31 | 12 | 500 | 2,500 |
| Q | 7343-12 | 12 | 1,000 | 3,000 |
| Y | 7343-40 | 12 | 500 | 2,000 |
| X | 7343-43 | 12 | 500 | 2,000 |
| E/T428P | 7360-38 | 12 | 500 | 2,000 |
| H | 7360-20 | 12 | 1,000 | 2,500 |

* No C-Spec required for 7" reel packaging. C-7280 required for 13" reel packaging.

Figure 1 – Embossed (Plastic) Carrier Tape Dimensions

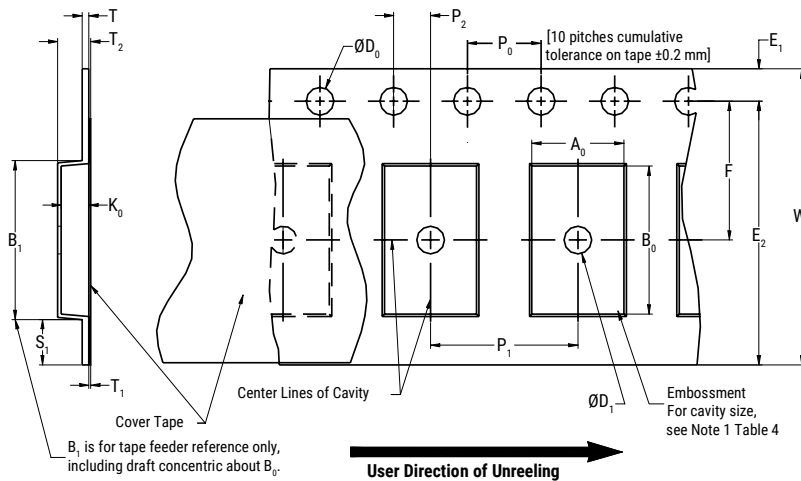

Table 4 – Embossed (Plastic) Carrier Tape Dimensions

Metric will govern

| Constant Dimensions – Millimeters (Inches) | | | | | | | | | |
|--|--------------------------------------|----------------------------------|----------------------------|---------------------------|---------------------------|-----------------------|----------------------------------|------------------|------------------------|
| Tape Size | D ₀ | D ₁ Minimum Note 1 | E ₁ | P ₀ | P ₂ | R Reference Note 2 | S ₁ Minimum Note 3 | T Maximum | T ₁ Maximum |
| 8 mm | 1.5 +0.10/-0.0 (0.059+0.004/-0.0) | 1.0 (0.039) | 1.75±0.10 (0.069±0.004) | 4.0±0.10 (0.157±0.004) | 2.0±0.05 (0.079±0.002) | 25.0 (0.984) | 0.600 (0.024) | 0.600 (0.024) | 0.100 (0.004) |
| 12 mm | | 1.5 (0.059) | | | | | | | |

| Variable Dimensions – Millimeters (Inches) | | | | | | | | | |
|--|-------------------------------------|----------------------------------|------------------------|---------------------------|--|------------------------|-----------------|--|--|
| Tape Size | Pitch | B ₁ Maximum Note 4 | E ₂ Minimum | F | P ₁ | T ₂ Maximum | W Maximum | A ₀ , B ₀ & K ₀ | |
| 8 mm | Single (4 mm) | 4.35 (0.171) | 6.25 (0.246) | 3.5±0.05 (0.138±0.002) | 2.0±0.05 or 4.0±0.10 (0.079±0.002 or 0.157±0.004) | 2.5 (0.098) | 8.3 (0.327) | Note 5 | |
| 12 mm | Single (4 mm) & Double (8 mm) | 8.2 (0.323) | 10.25 (0.404) | 5.5±0.05 (0.217±0.002) | 2.0±0.05 (0.079±0.002) or 4.0±0.10 (0.157±0.004) or 8.0±0.10 (0.315±0.004) | 4.6 (0.181) | 12.3 (0.484) | | |

- The embossment hole location shall be measured from the sprocket hole controlling the location of the embossment. Dimensions of embossment location and hole location shall be applied independent of each other.
- The tape, with or without components, shall pass around R without damage (see Figure 4).
- If S₁ < 1.0 mm, there may not be enough area for cover tape to be properly applied (see EIA Standard 481–D, paragraph 4.3, section b).
- B₁ dimension is a reference dimension for tape feeder clearance only.
- The cavity defined by A₀, B₀ and K₀ shall surround the component with sufficient clearance that:
 - the component does not protrude above the top surface of the carrier tape.
 - the component can be removed from the cavity in a vertical direction without mechanical restriction, after the top cover tape has been removed.
 - rotation of the component is limited to 20° maximum for 8 and 12 mm tapes (see Figure 2).
 - lateral movement of the component is restricted to 0.5 mm maximum for 8 mm and 12 mm wide tape (see Figure 3).
 - see Addendum in EIA Standard 481–D for standards relating to more precise taping requirements.

Packaging Information Performance Notes

- 1. Cover Tape Break Force:** 1.0 kg minimum.
- 2. Cover Tape Peel Strength:** The total peel strength of the cover tape from the carrier tape shall be:

| Tape Width | Peel Strength |
|------------|----------------------------------|
| 8 mm | 0.1 to 1.0 Newton (10 to 100 gf) |
| 12 mm | 0.1 to 1.3 Newton (10 to 130 gf) |

The direction of the pull shall be opposite the direction of the carrier tape travel. The pull angle of the carrier tape shall be 165° to 180° from the plane of the carrier tape. During peeling, the carrier and/or cover tape shall be pulled at a velocity of 300 ±10 mm/minute.

- 3. Labeling:** Bar code labeling (standard or custom) shall be on the side of the reel opposite the sprocket holes. Refer to EIA Standards 556 and 624.

Figure 2 – Maximum Component Rotation

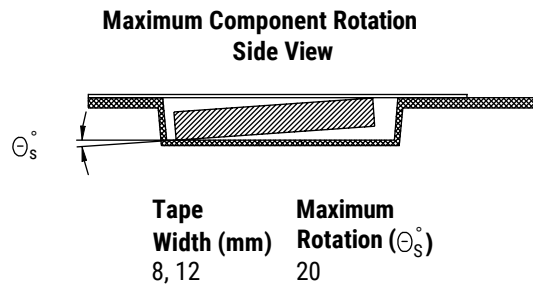

Figure 3 – Maximum Lateral Movement

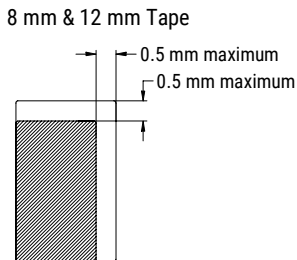

Figure 4 – Bending Radius

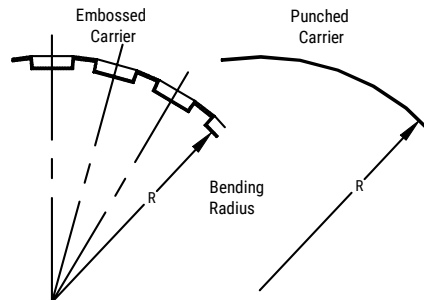

Figure 5 – Reel Dimensions



Note: Drive spokes optional; if used, dimensions B and D shall apply.

Table 5 – Reel Dimensions

Metric will govern

| Constant Dimensions – Millimeters (Inches) | | | | |
|--|----------------------------|-------------------------------------|--------------------------------------|---|
| Tape Size | A | B Minimum | C | D Minimum |
| 8 mm | 178±0.20 (7.008±0.008) | 1.5 (0.059) | 13.0+0.5/-0.2 (0.521+0.02/-0.008) | 20.2 (0.795) |
| 12 mm | 330±0.20 (13.000±0.008) | | | |
| Variable Dimensions – Millimeters (Inches) | | | | |
| Tape Size | N Minimum | W ₁ | W ₂ Maximum | W ₃ |
| 8 mm | 50 (1.969) | 8.4+1.5/-0.0 (0.331+0.059/-0.0) | 14.4 (0.567) | Shall accommodate tape width without interference |
| 12 mm | | 12.4+2.0/-0.0 (0.488+0.078/-0.0) | 18.4 (0.724) | |

Figure 6 – Tape Leader & Trailer Dimensions

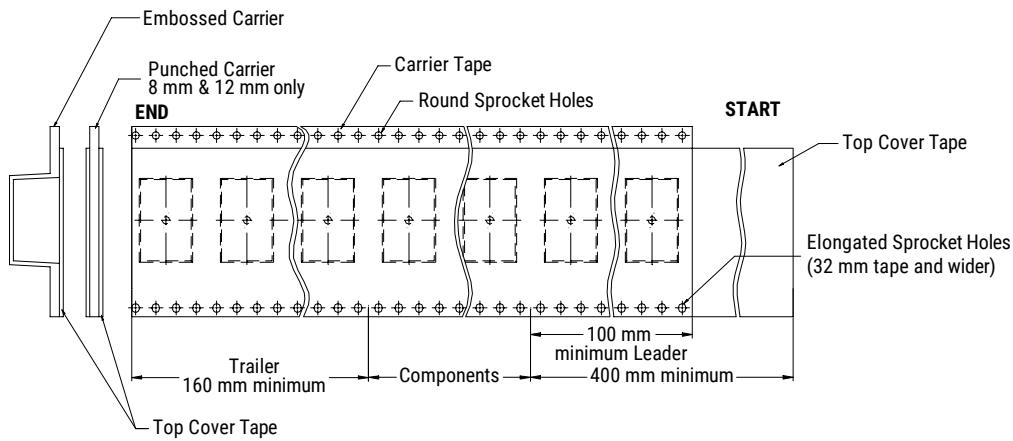
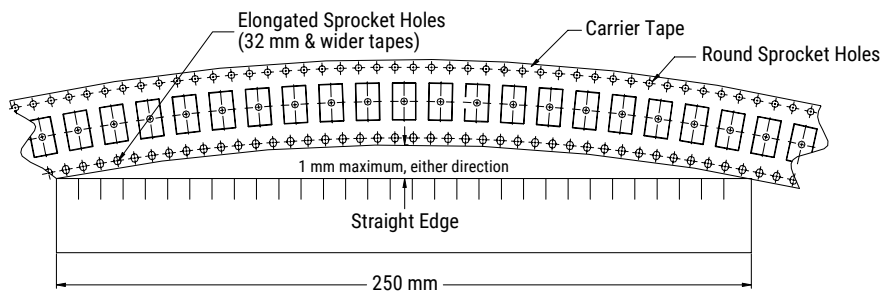

Figure 7 – Maximum Camber



KEMET Electronics Corporation Sales Offices

For a complete list of our global sales offices, please visit www.kemet.com/sales.

Disclaimer

All product specifications, statements, information and data (collectively, the "Information") in this datasheet are subject to change. The customer is responsible for checking and verifying the extent to which the Information contained in this publication is applicable to an order at the time the order is placed.

All Information given herein is believed to be accurate and reliable, but it is presented without guarantee, warranty, or responsibility of any kind, expressed or implied.

Statements of suitability for certain applications are based on KEMET Electronics Corporation's ("KEMET") knowledge of typical operating conditions for such applications, but are not intended to constitute – and KEMET specifically disclaims – any warranty concerning suitability for a specific customer application or use. The Information is intended for use only by customers who have the requisite experience and capability to determine the correct products for their application. Any technical advice inferred from this Information or otherwise provided by KEMET with reference to the use of KEMET's products is given gratis, and KEMET assumes no obligation or liability for the advice given or results obtained.

Although KEMET designs and manufactures its products to the most stringent quality and safety standards, given the current state of the art, isolated component failures may still occur. Accordingly, customer applications which require a high degree of reliability or safety should employ suitable designs or other safeguards (such as installation of protective circuitry or redundancies) in order to ensure that the failure of an electrical component does not result in a risk of personal injury or property damage.

Although all product-related warnings, cautions and notes must be observed, the customer should not assume that all safety measures are indicated or that other measures may not be required.

KEMET is a registered trademark of KEMET Electronics Corporation.